

1

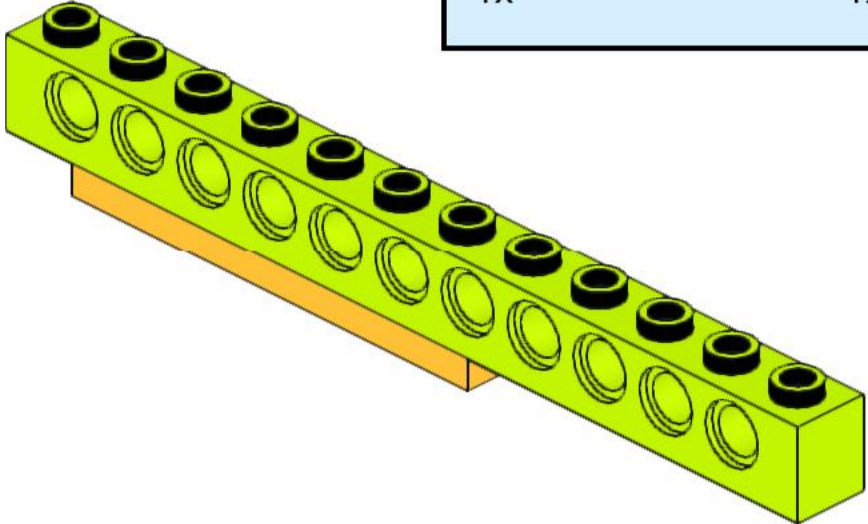

2

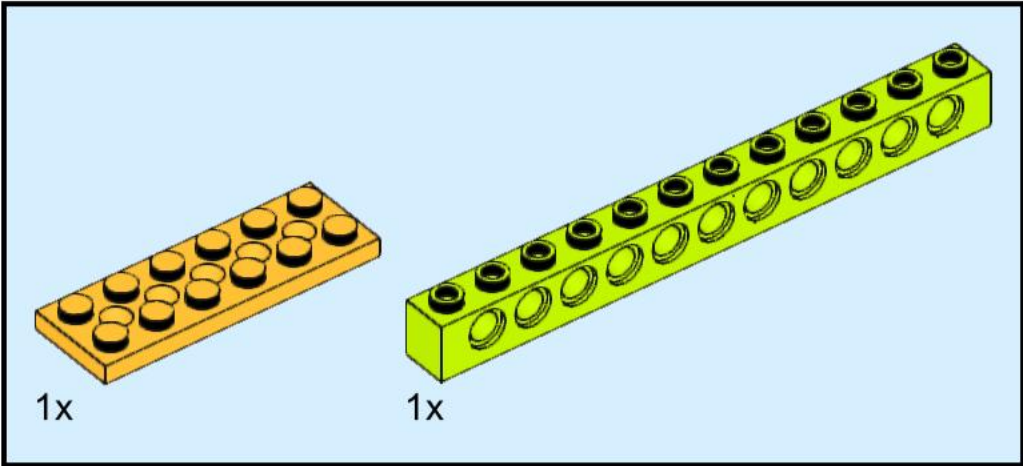
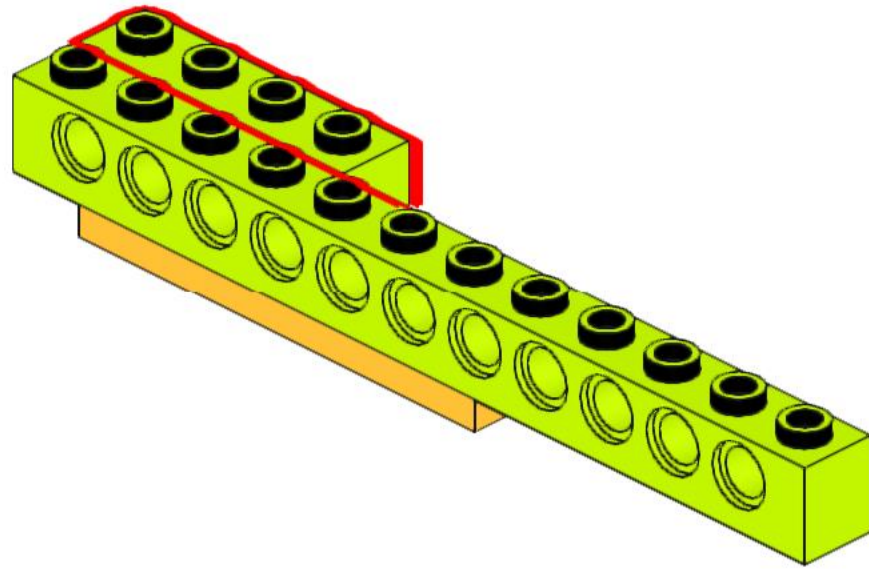
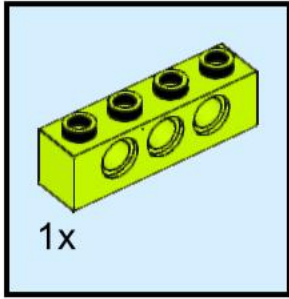

3

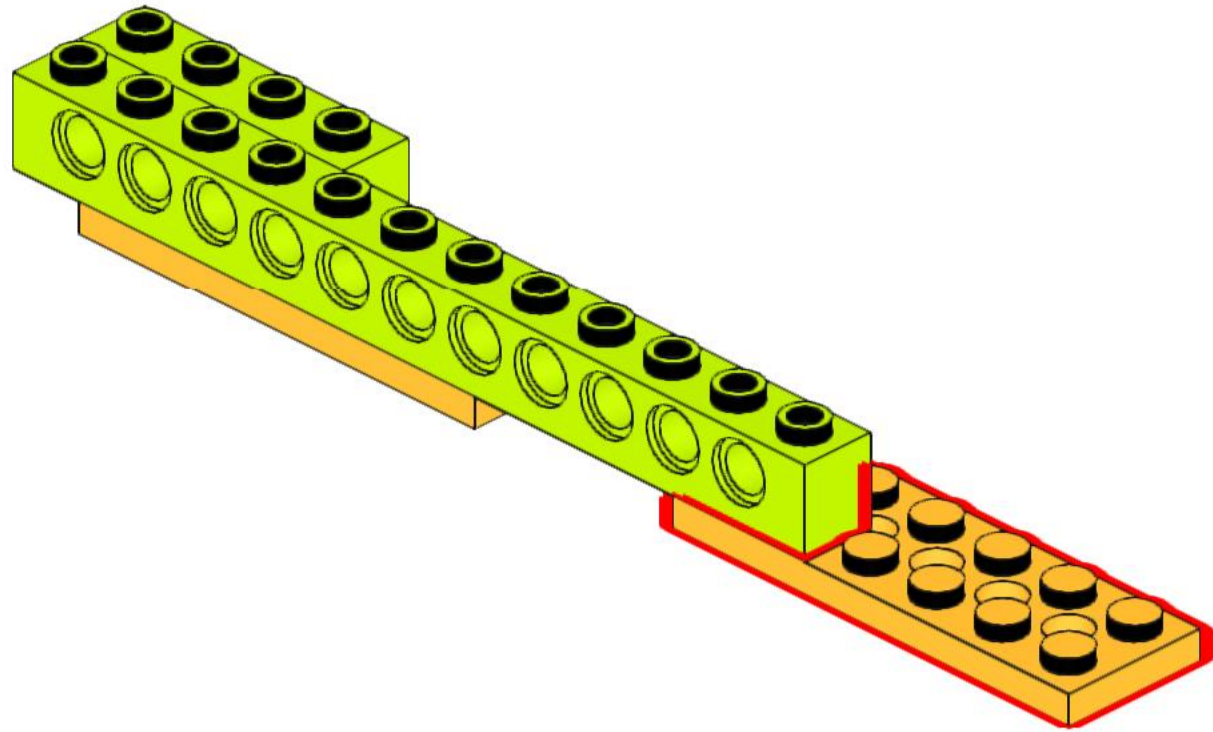
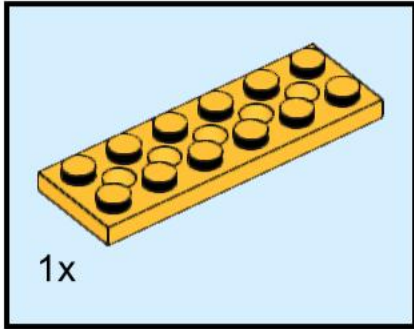

4

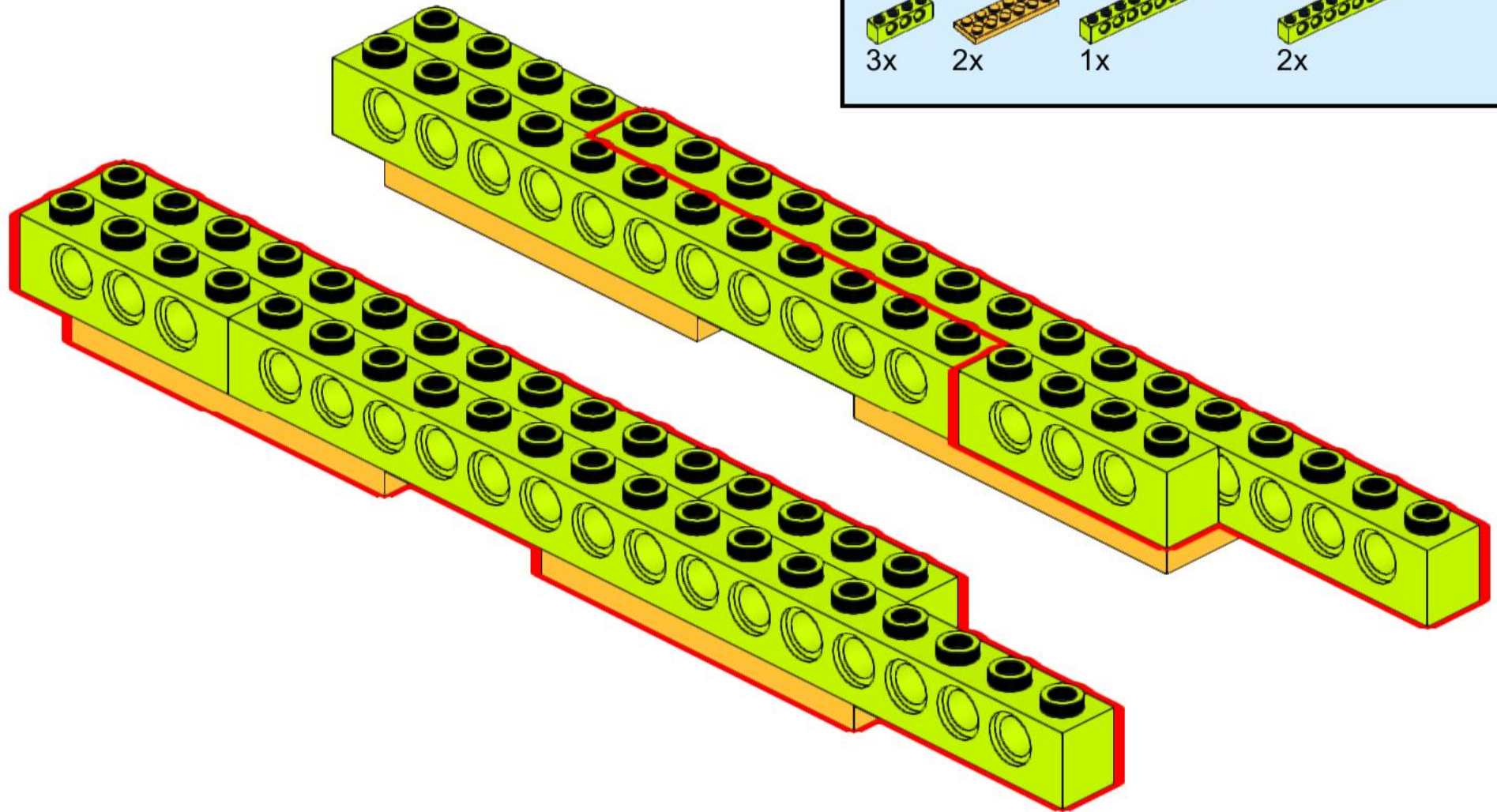
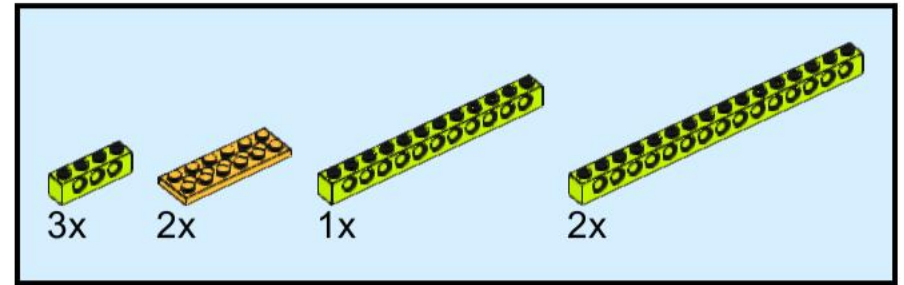

5

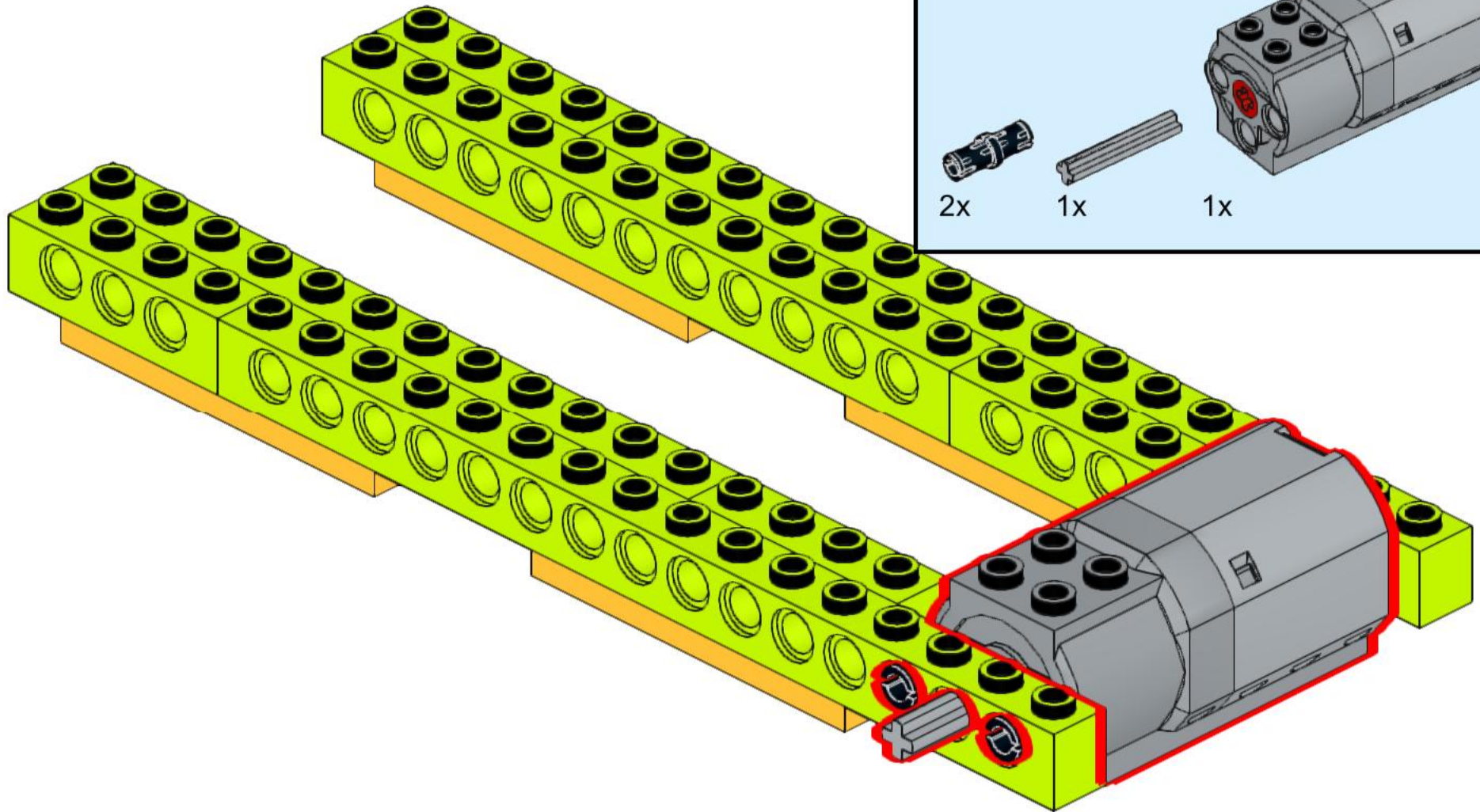

6

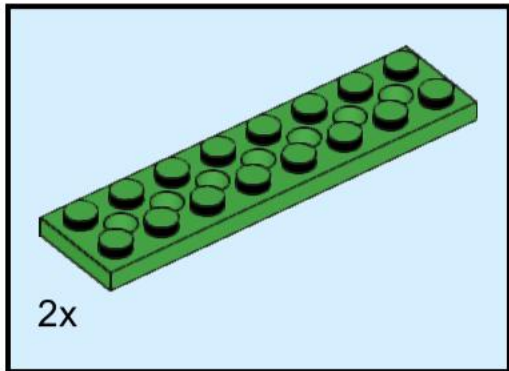
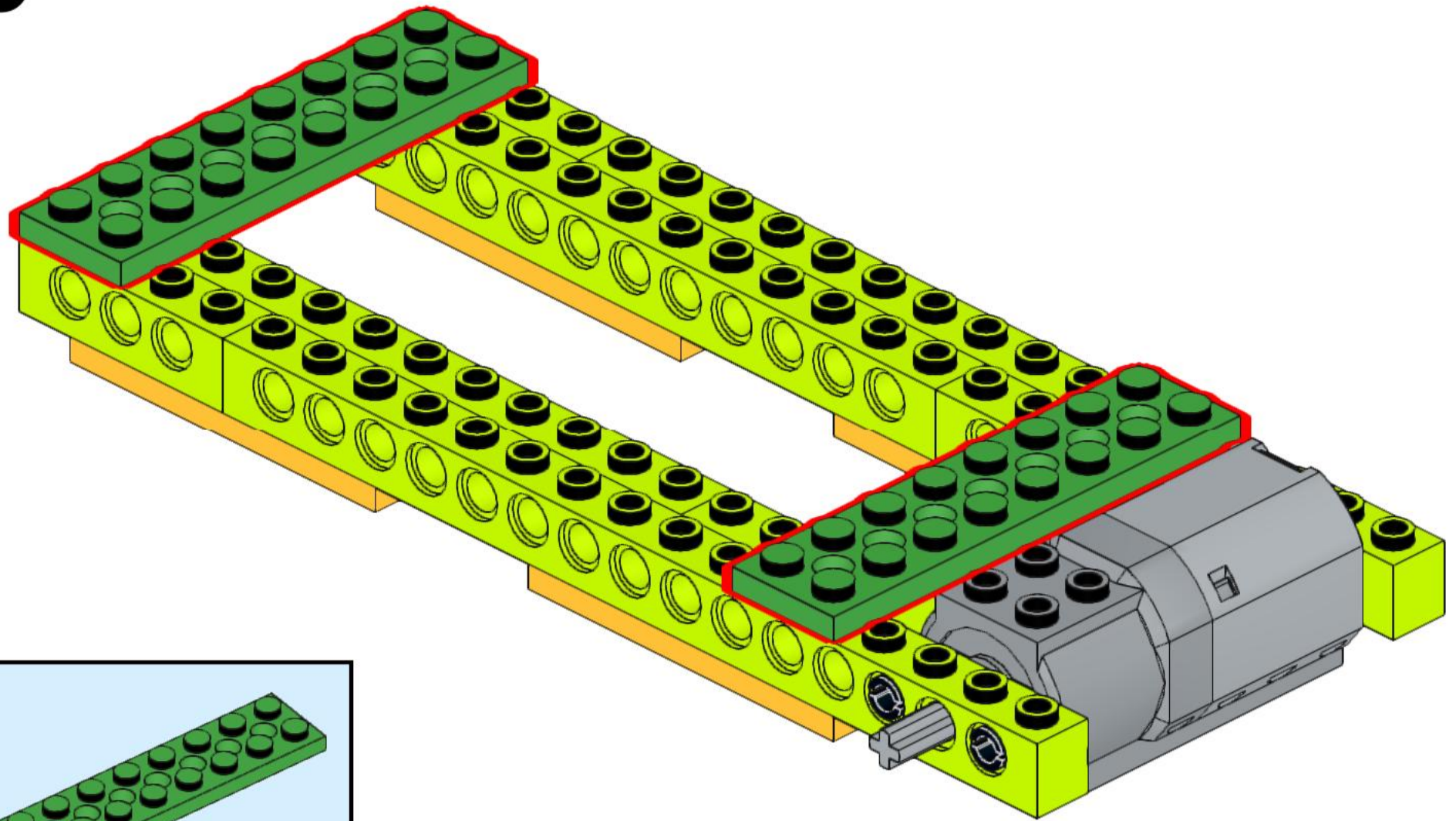

7

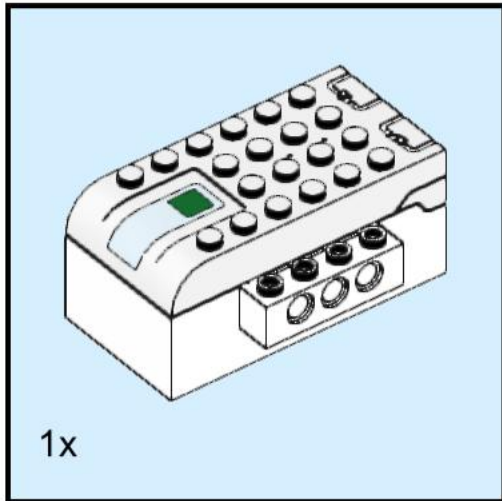
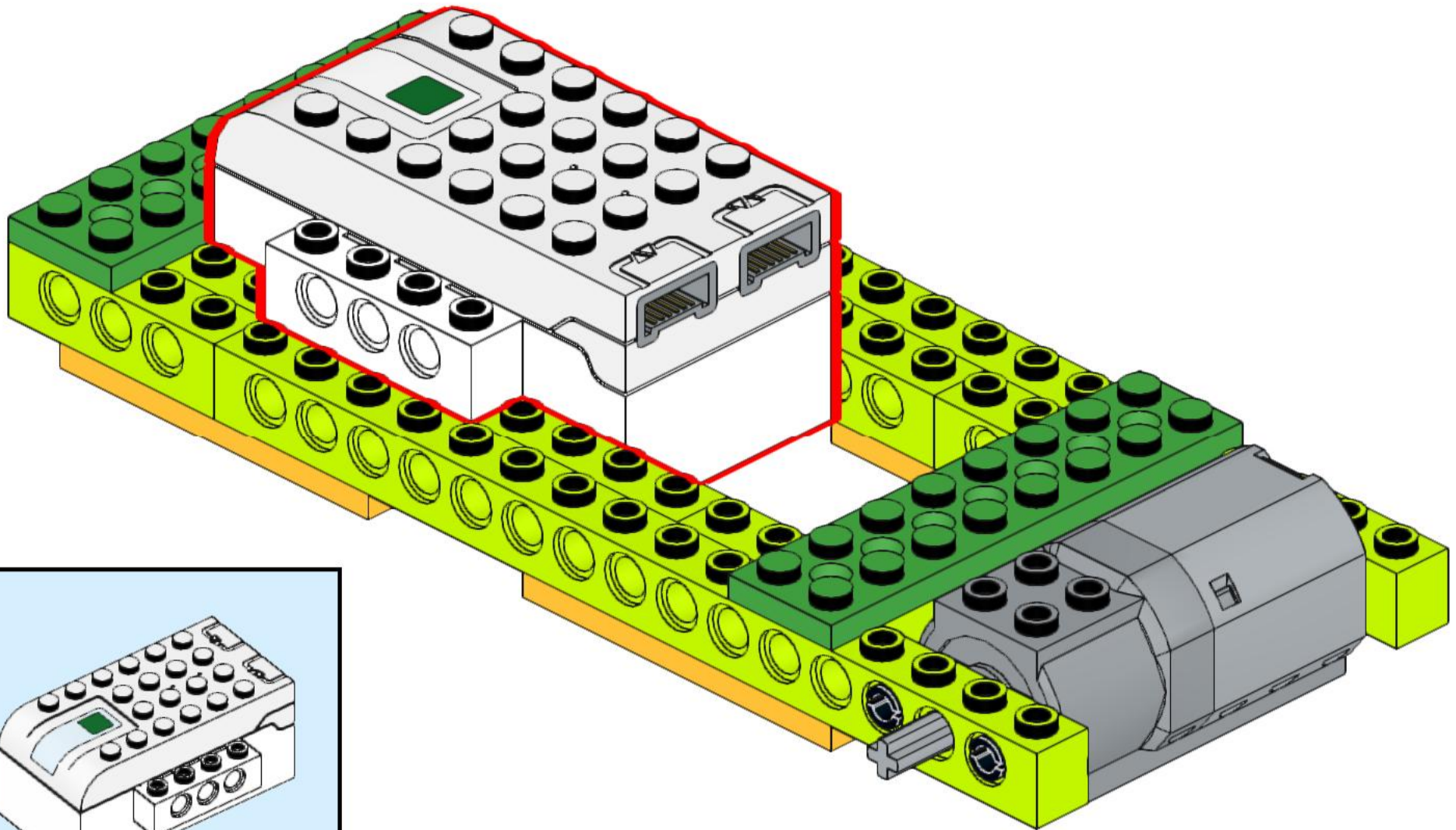

8

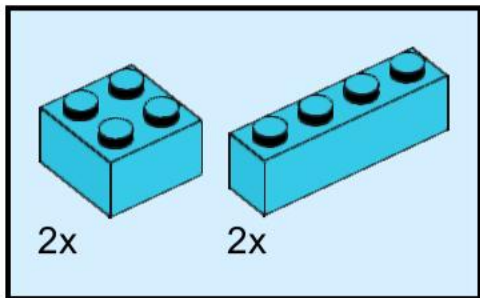
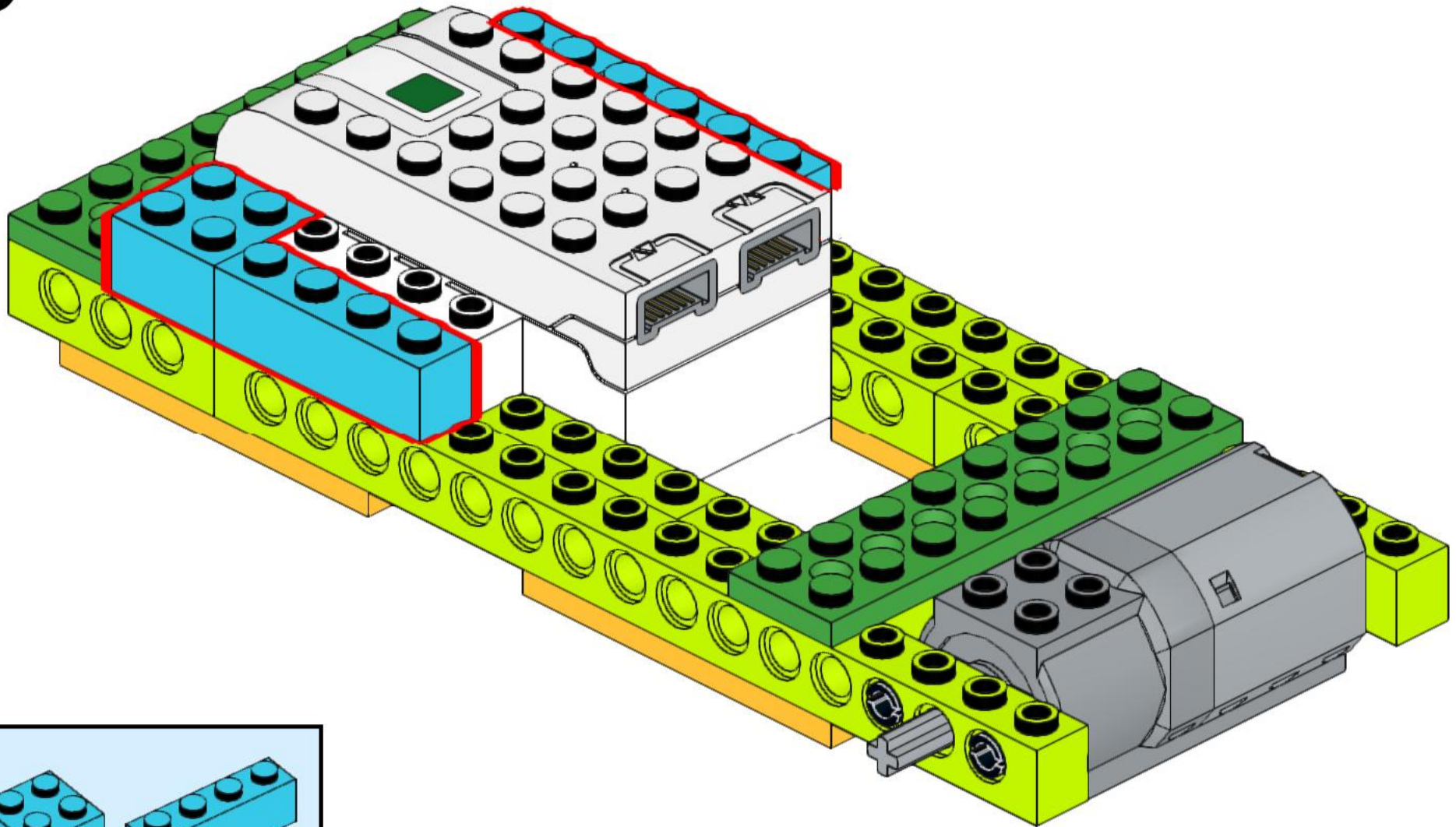



9

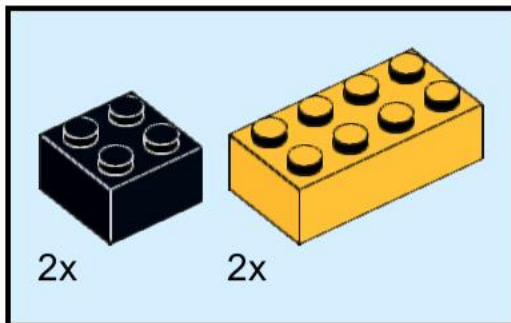
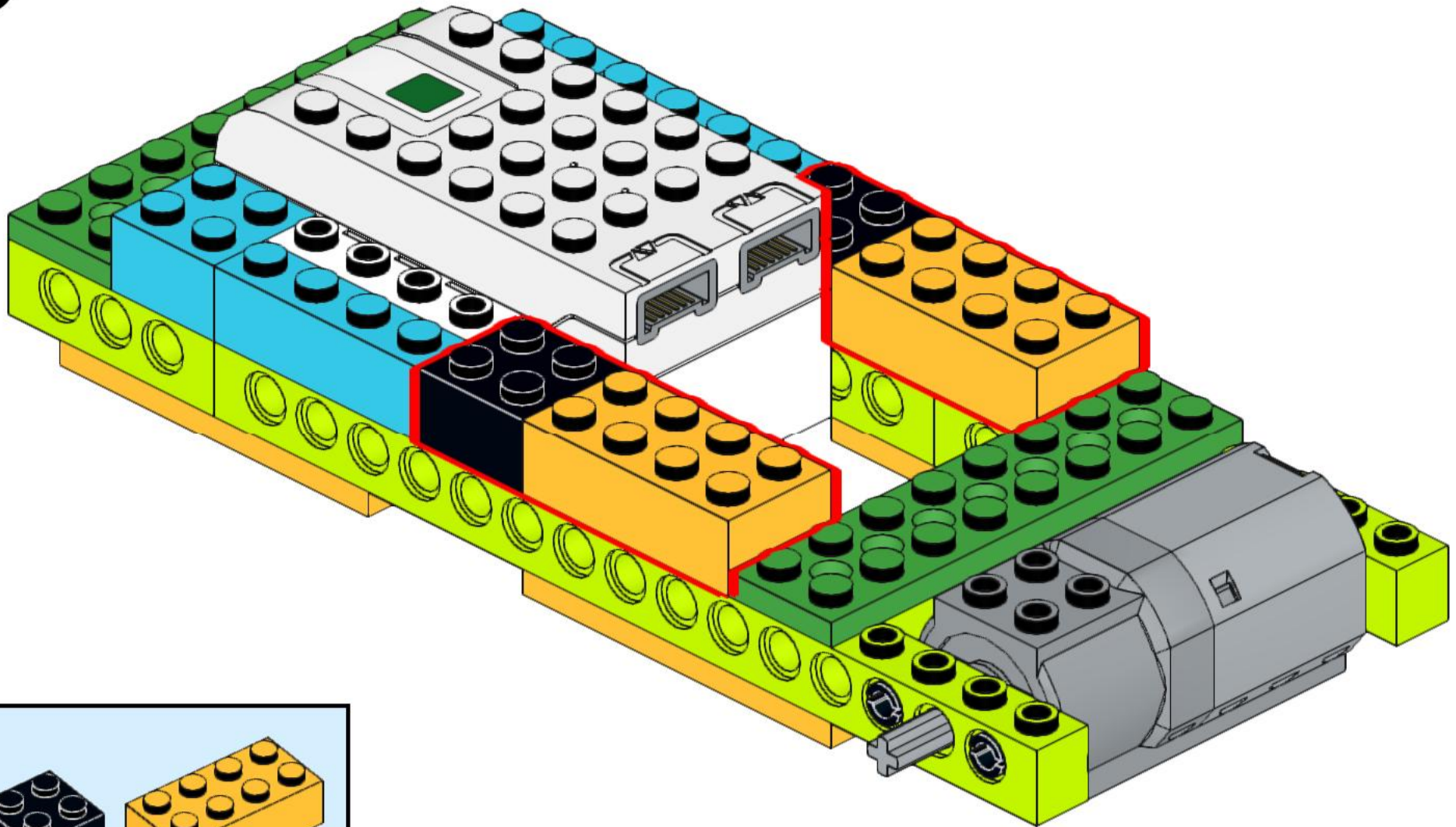

# 10

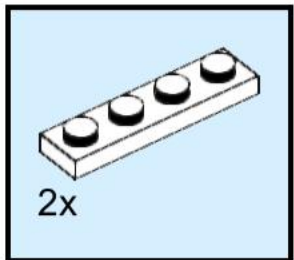
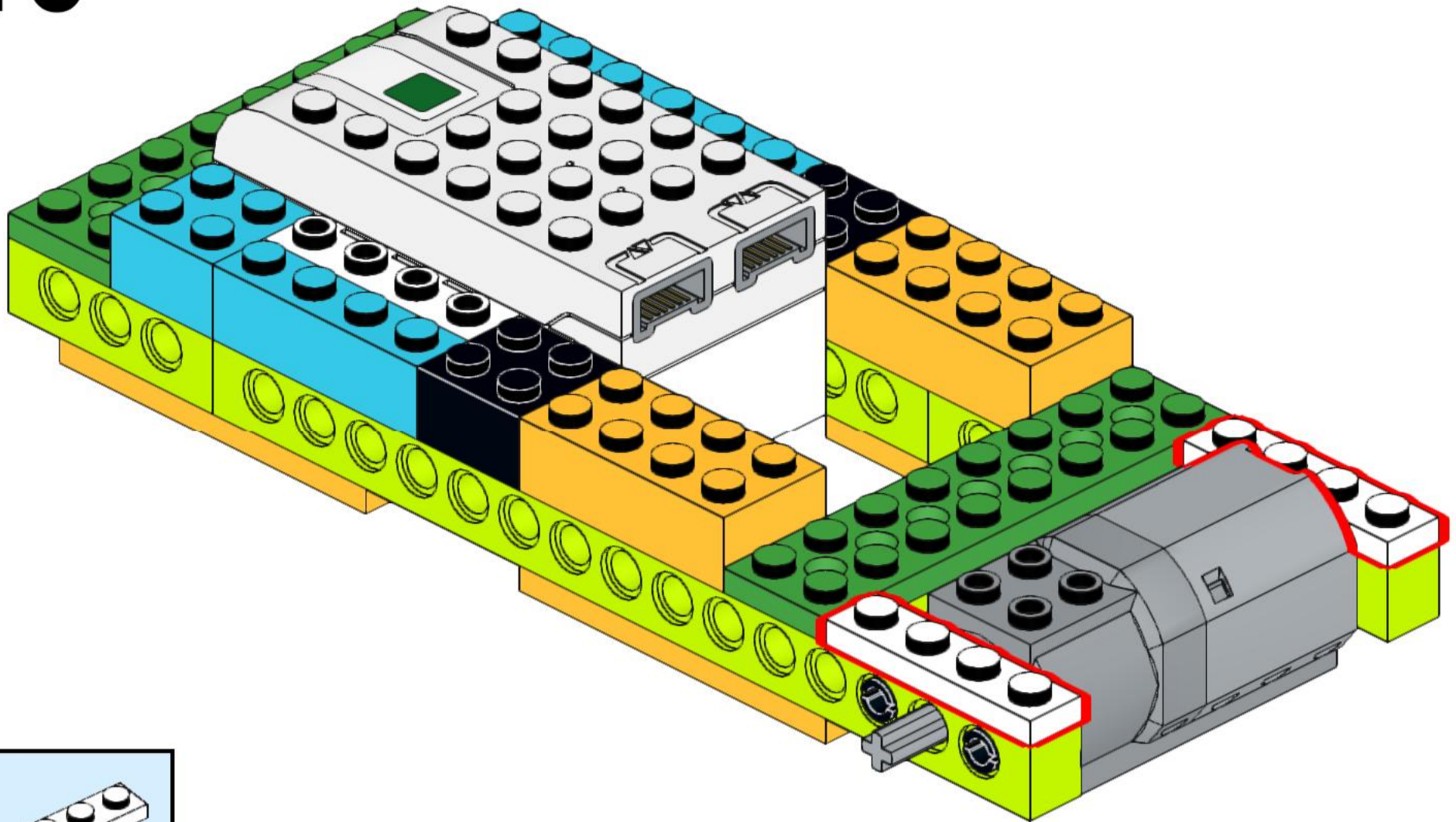

2x

# 11

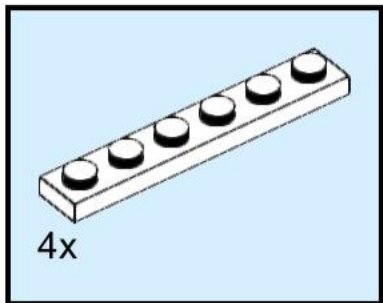
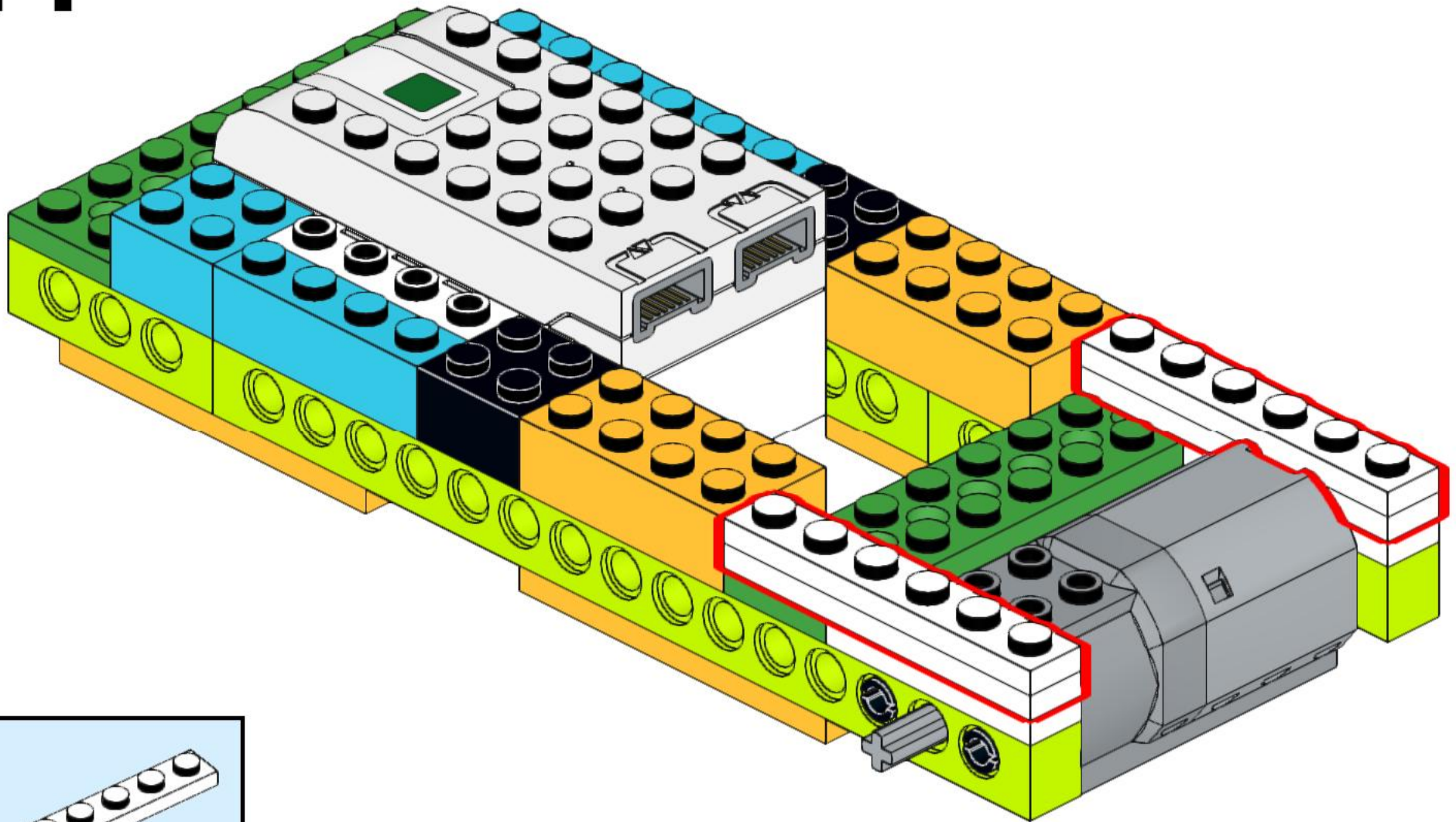

# 12

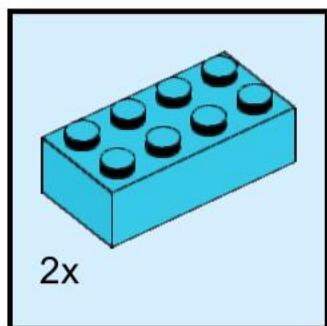
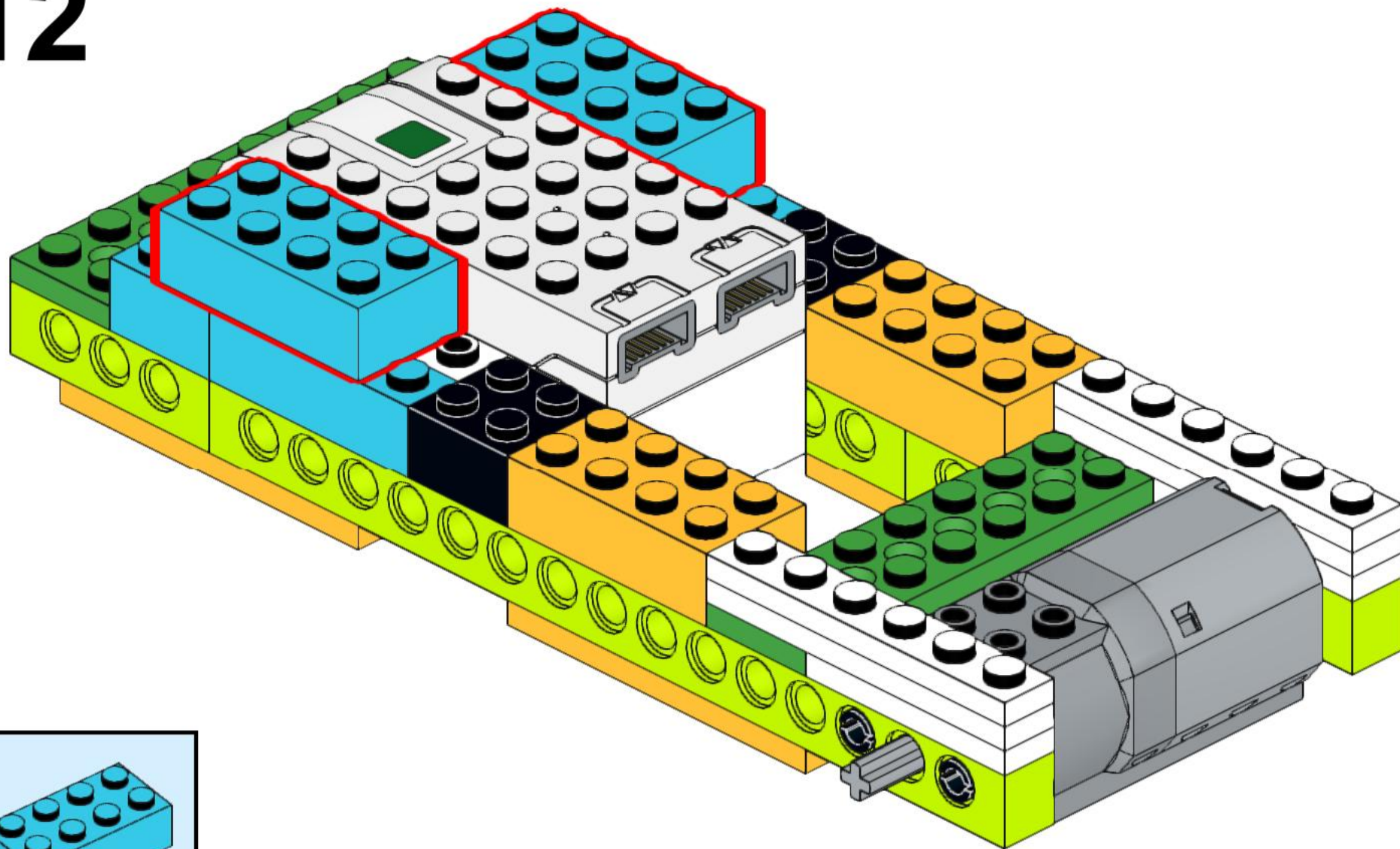

2x

# 13

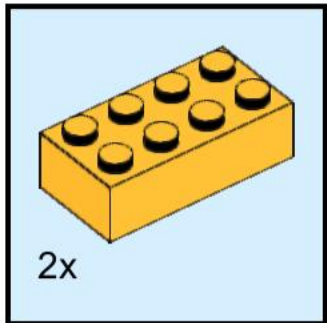
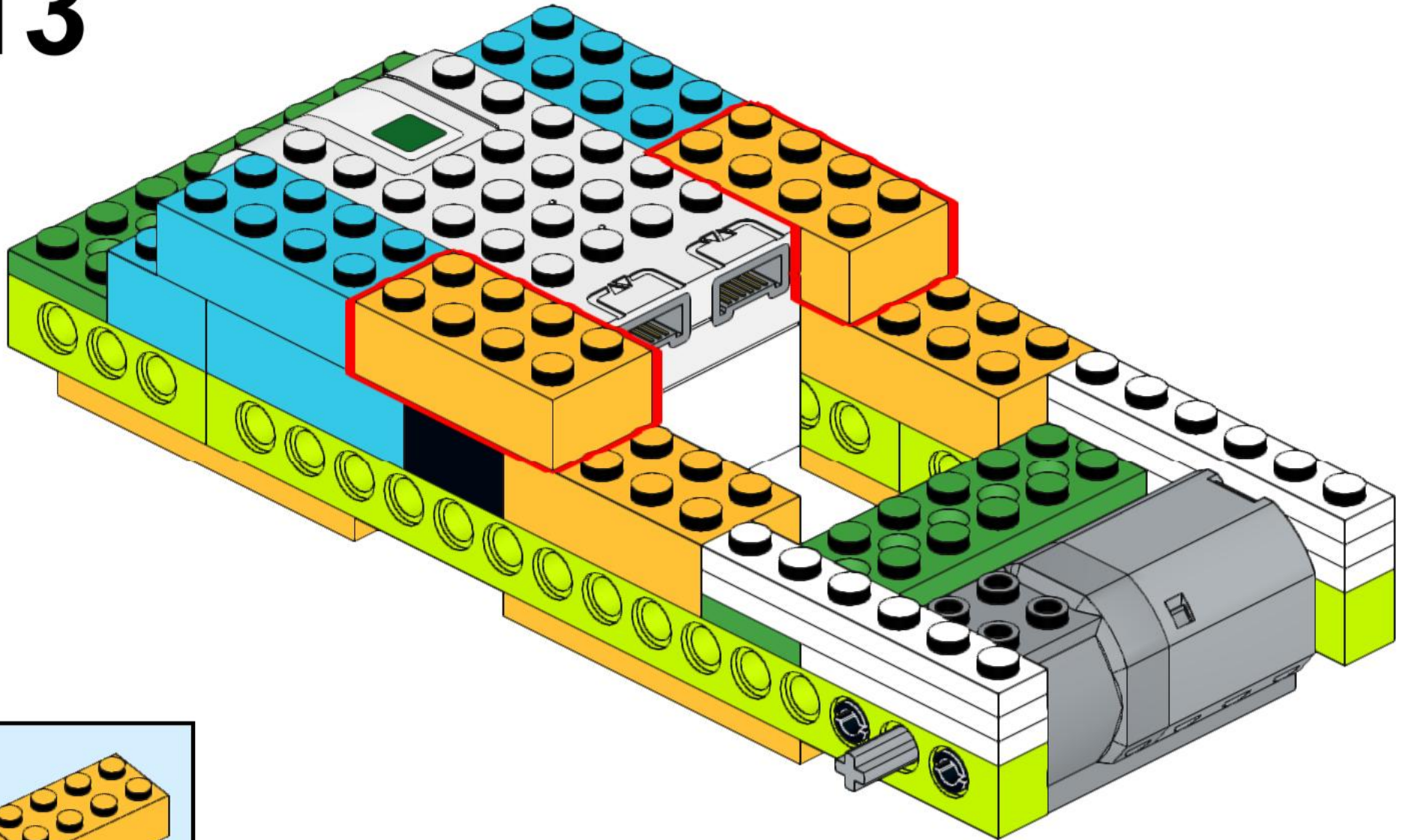

# 14

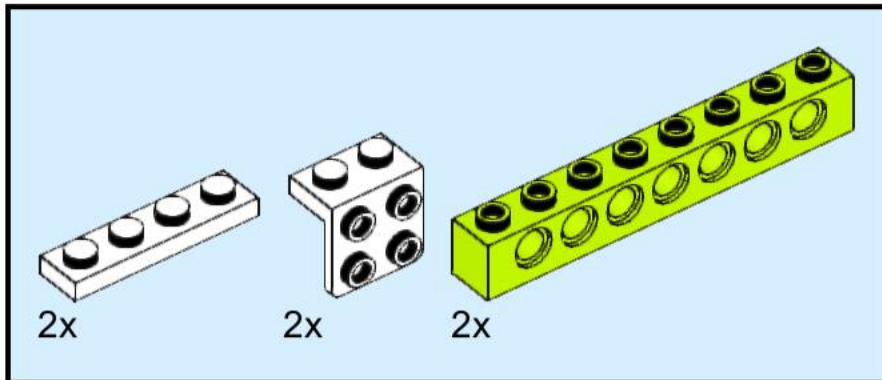
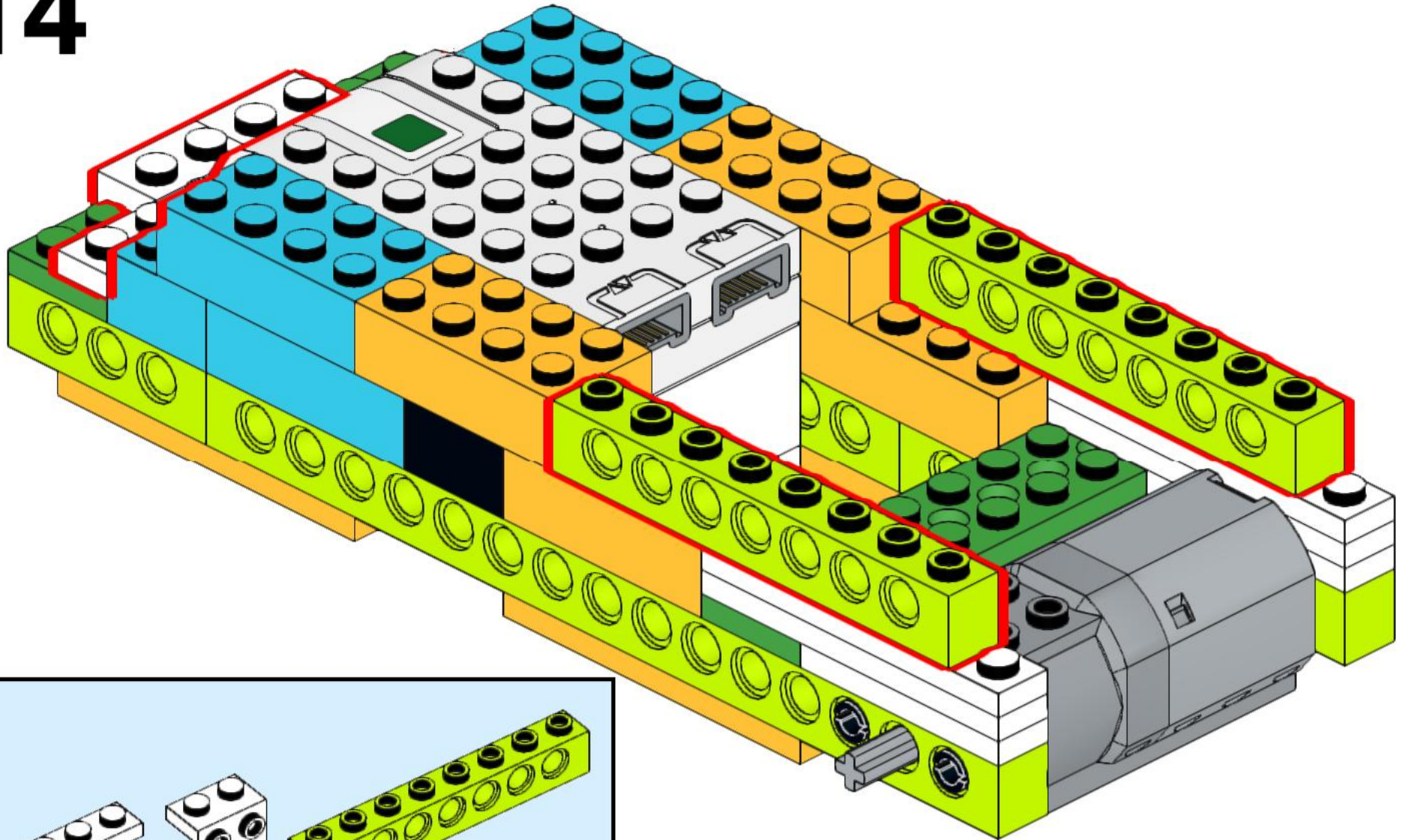

# 15

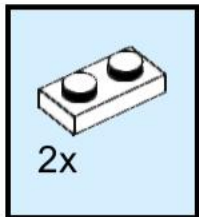
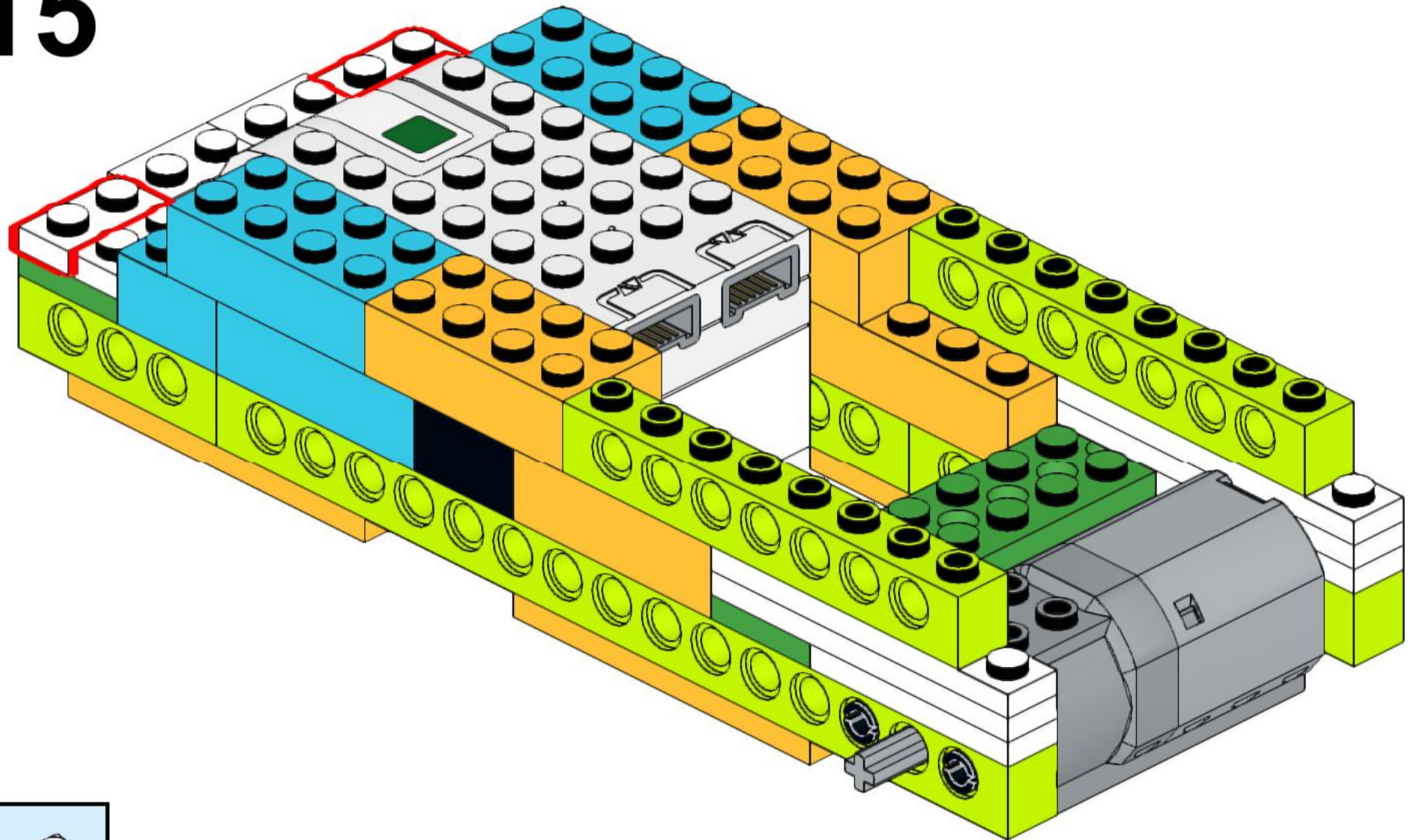

# 16

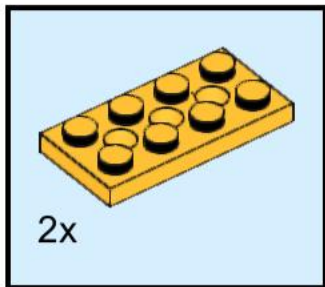
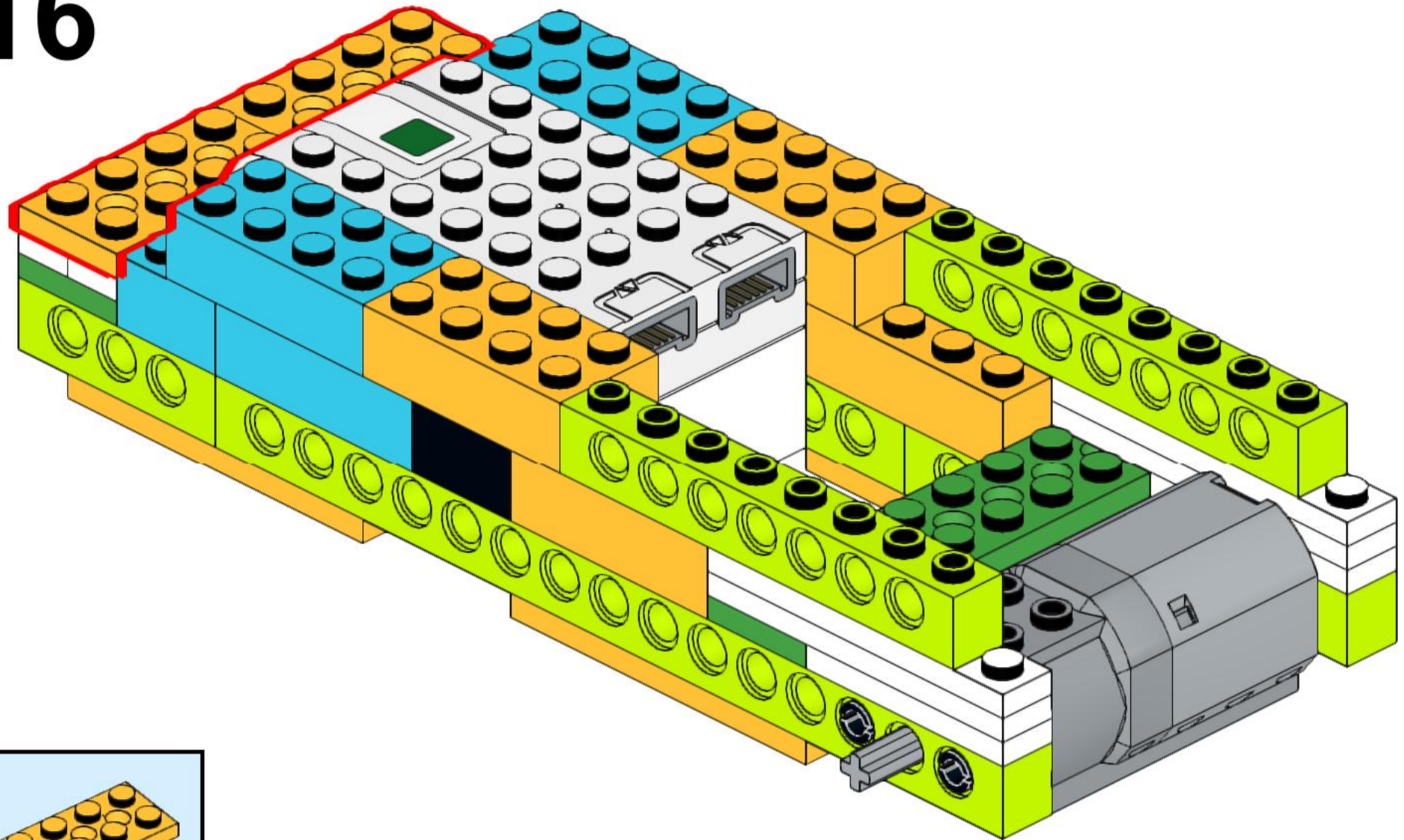

2x



17

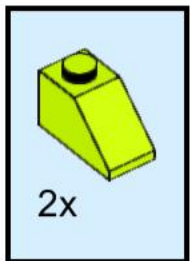
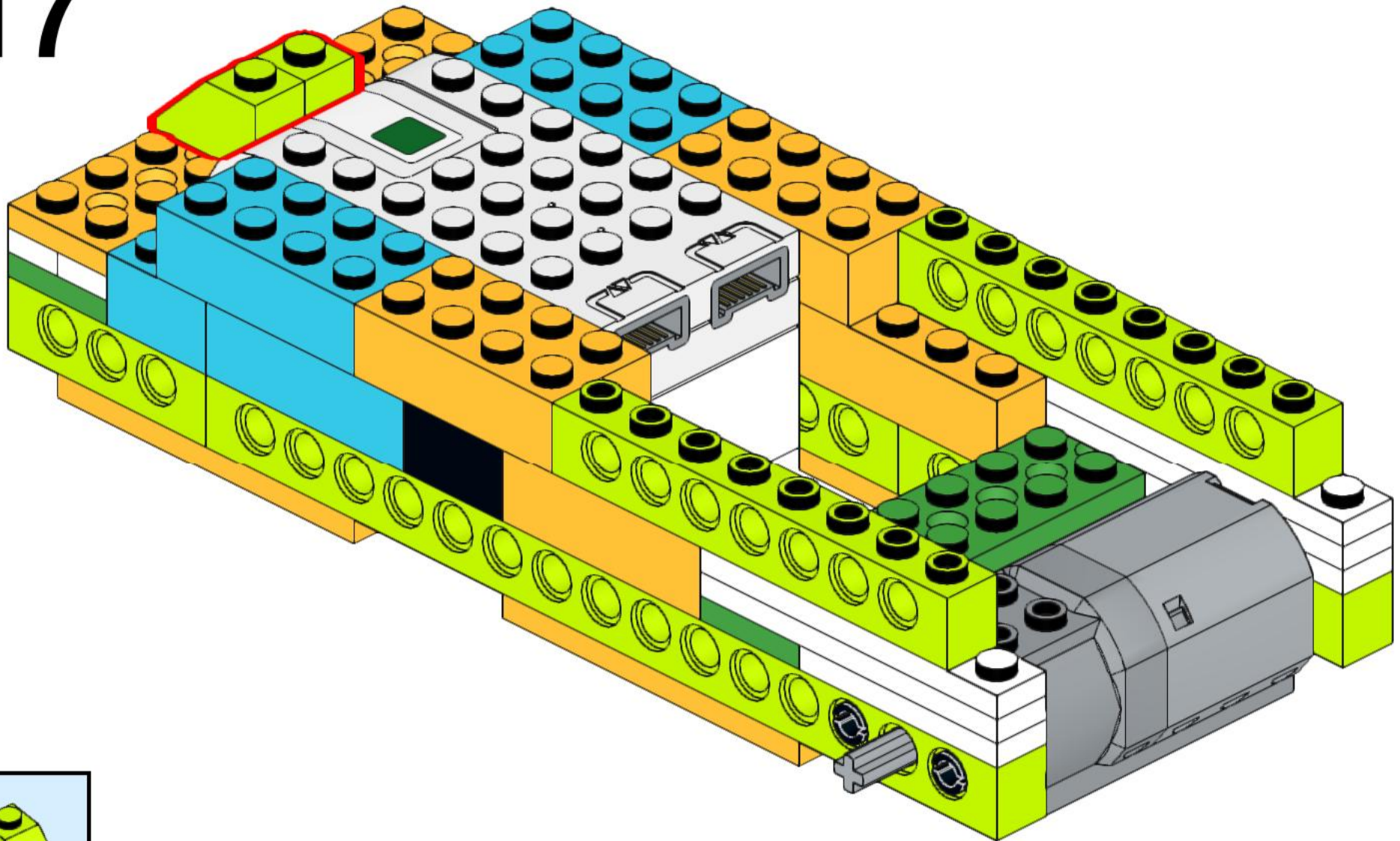

# 18

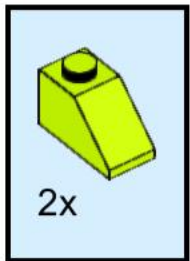
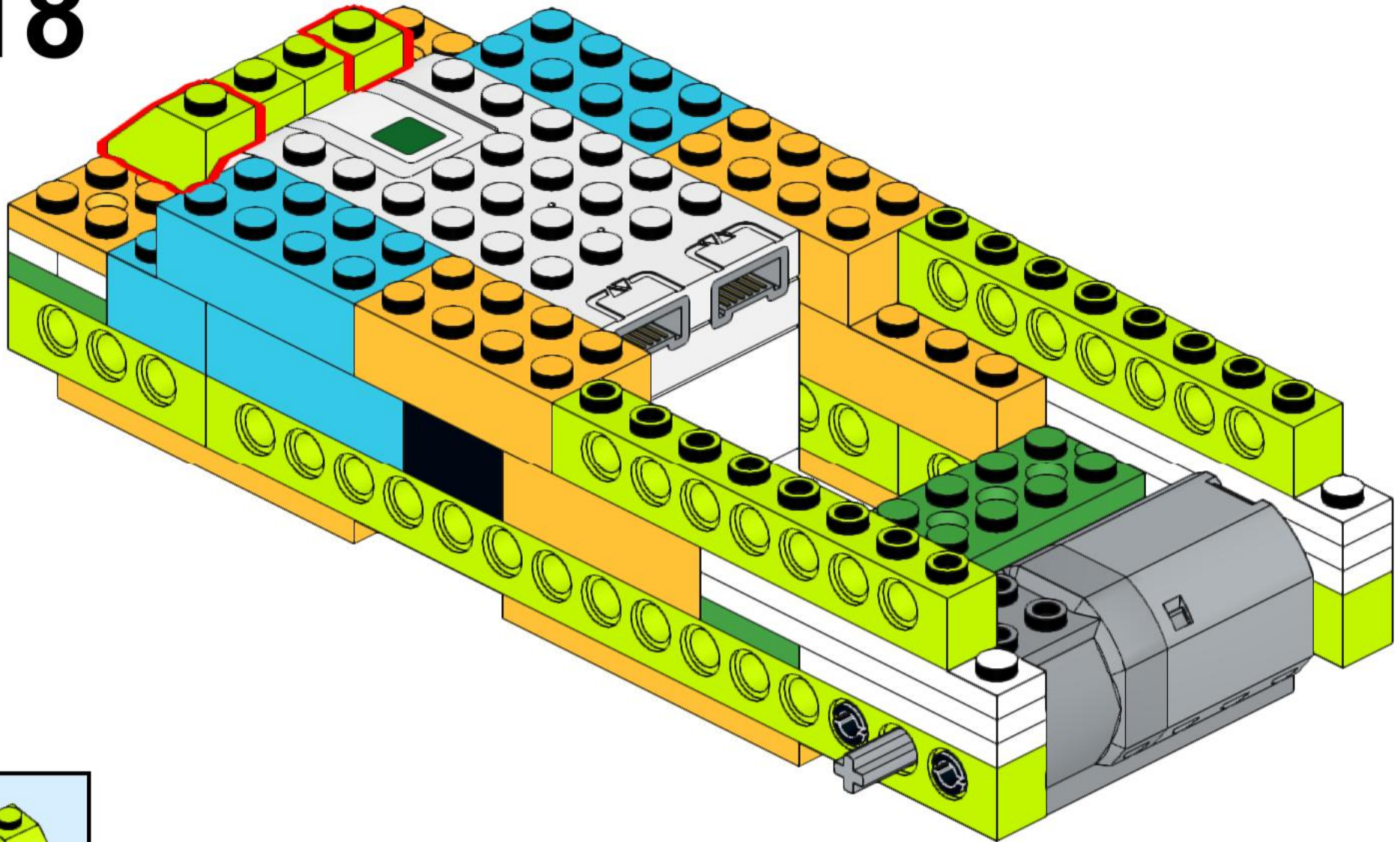

# 19

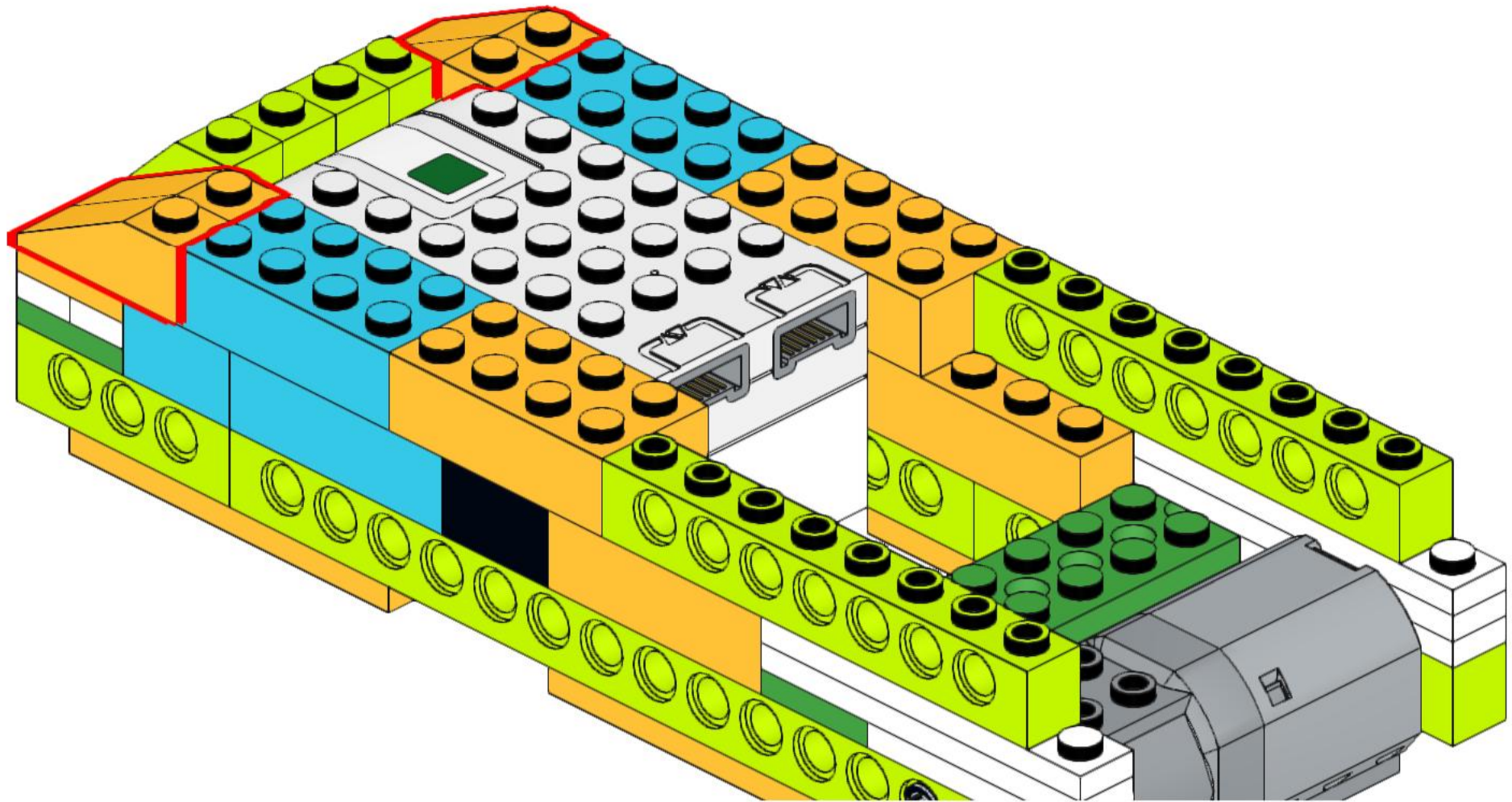
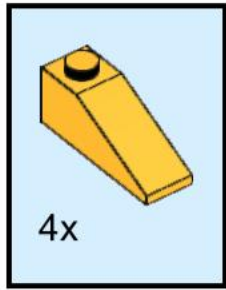

# 20

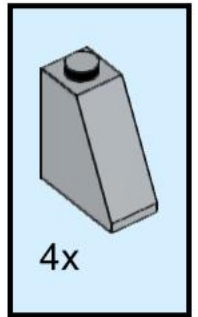
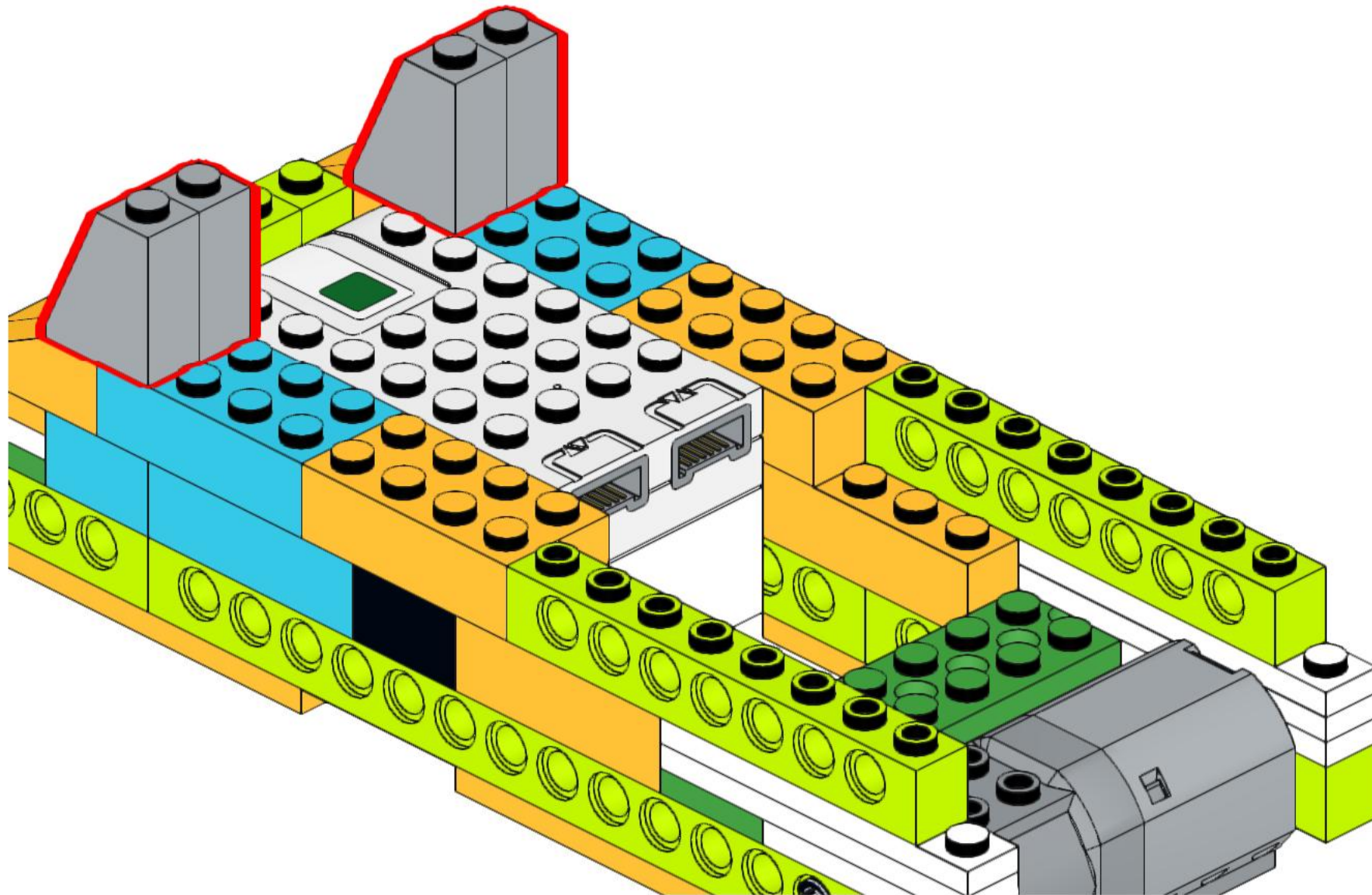

# 21

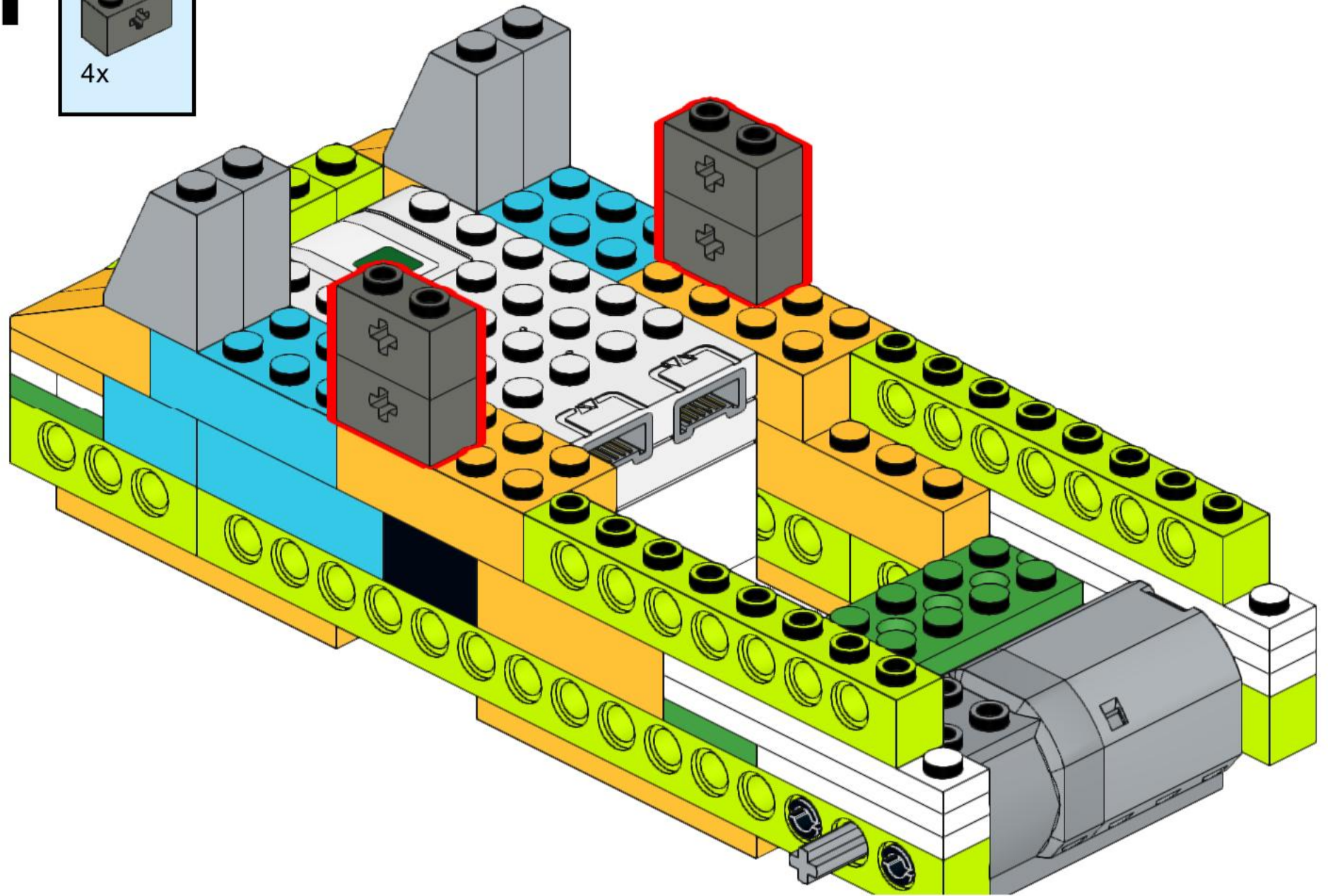
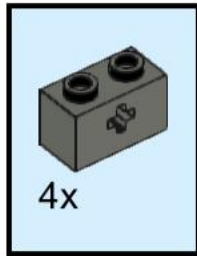

# 22

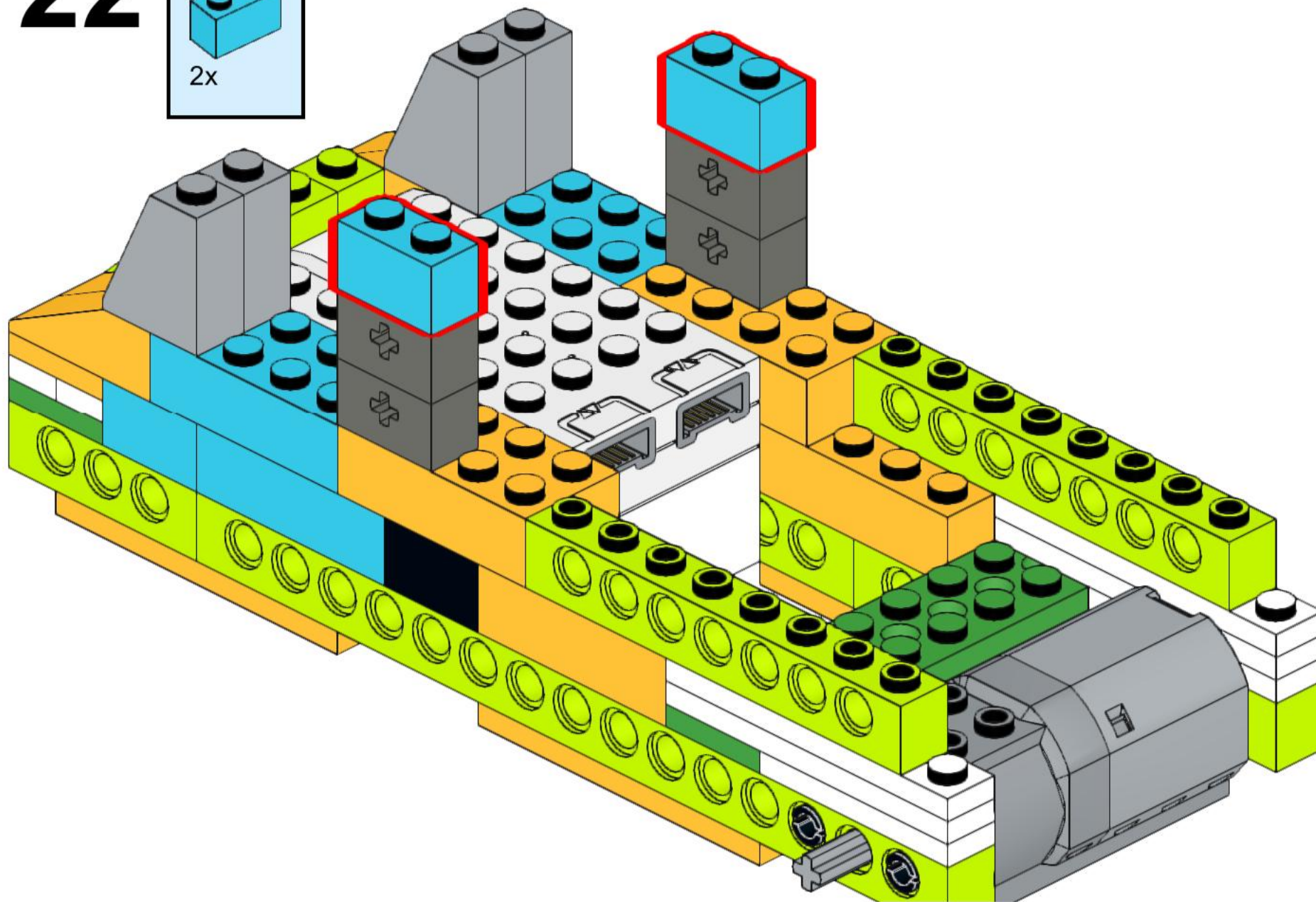
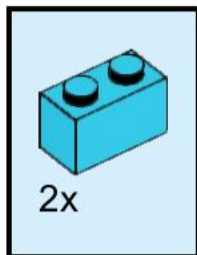

# 23

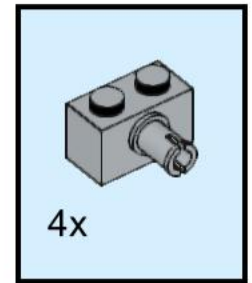
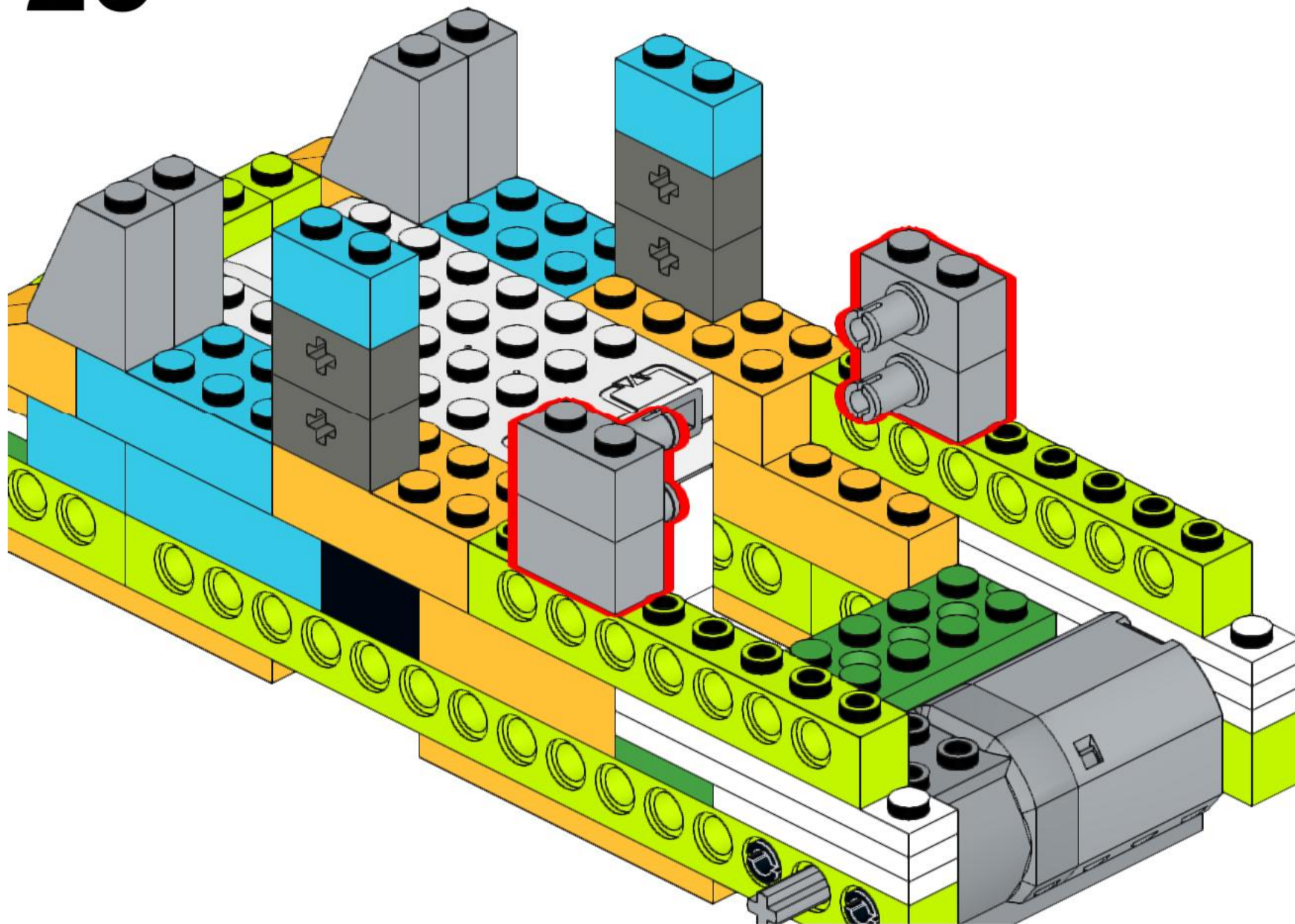

# 24

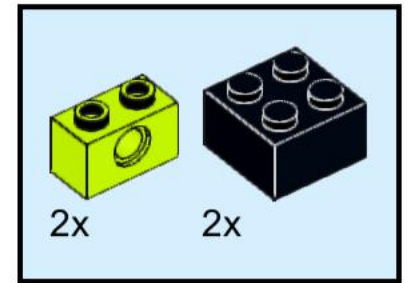
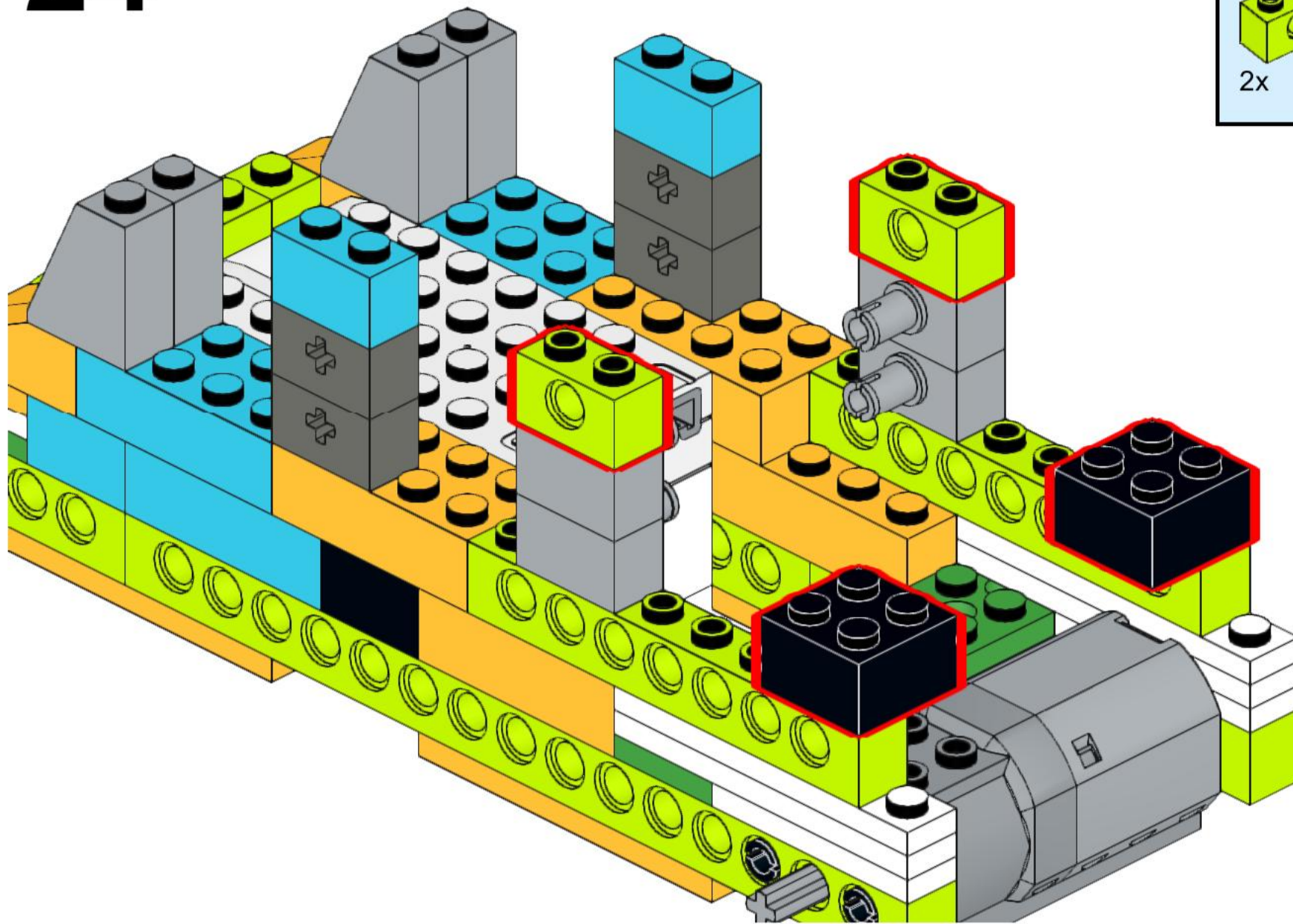



# 25

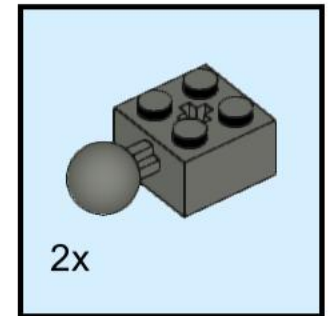
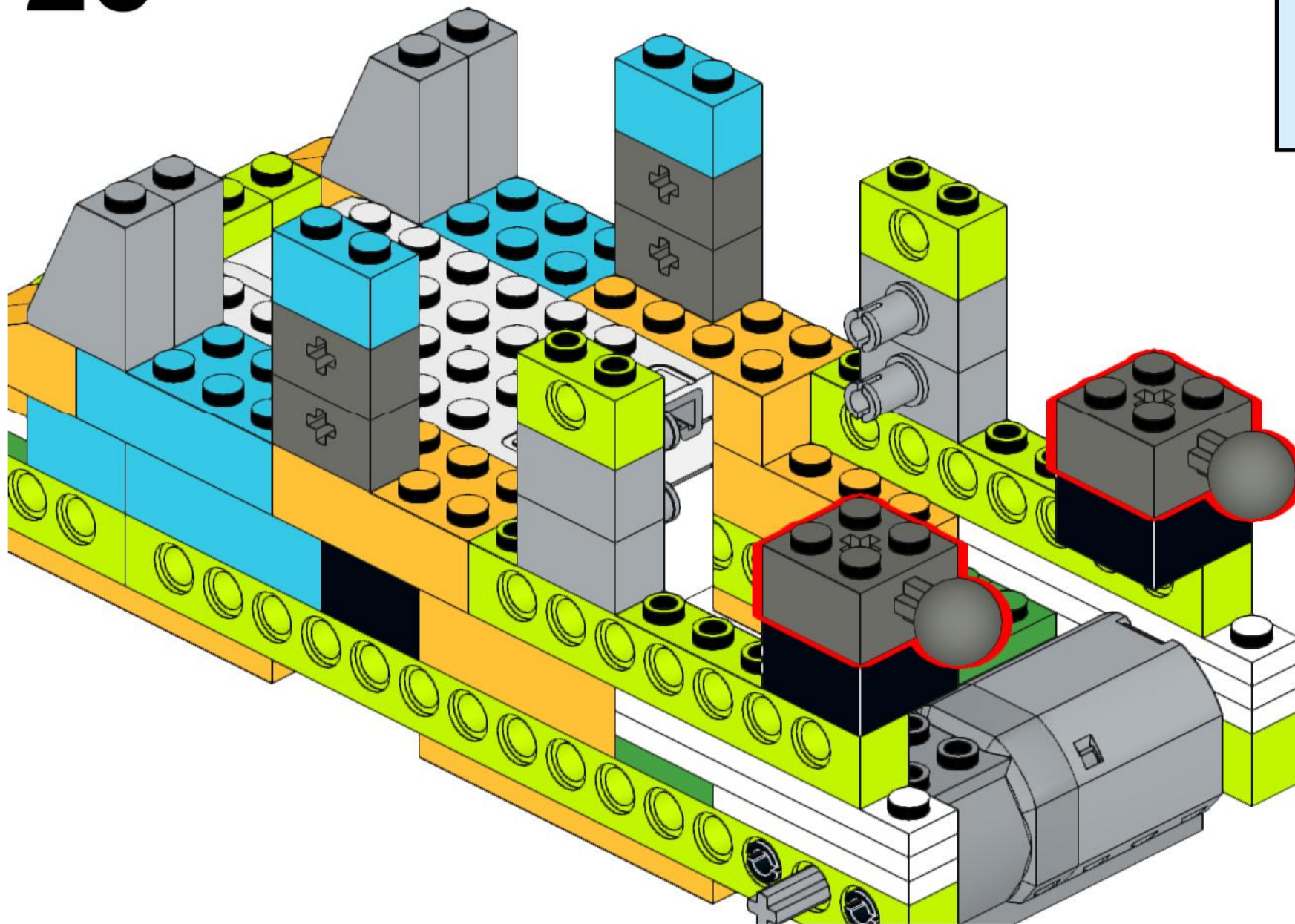

# 26

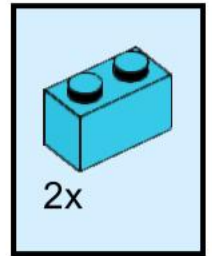
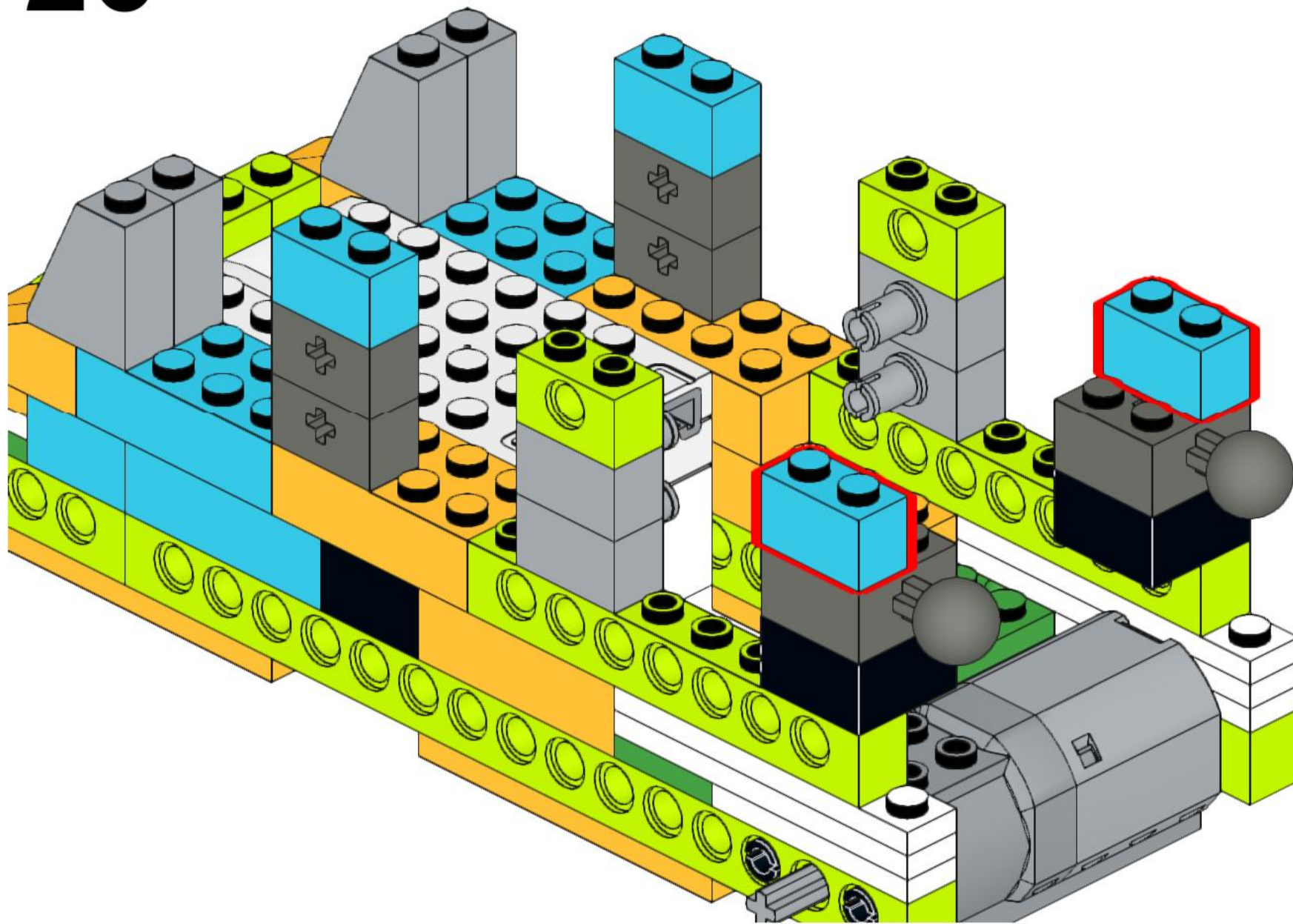

# 27

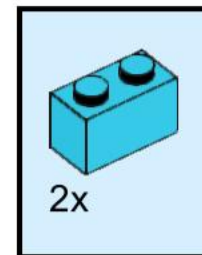
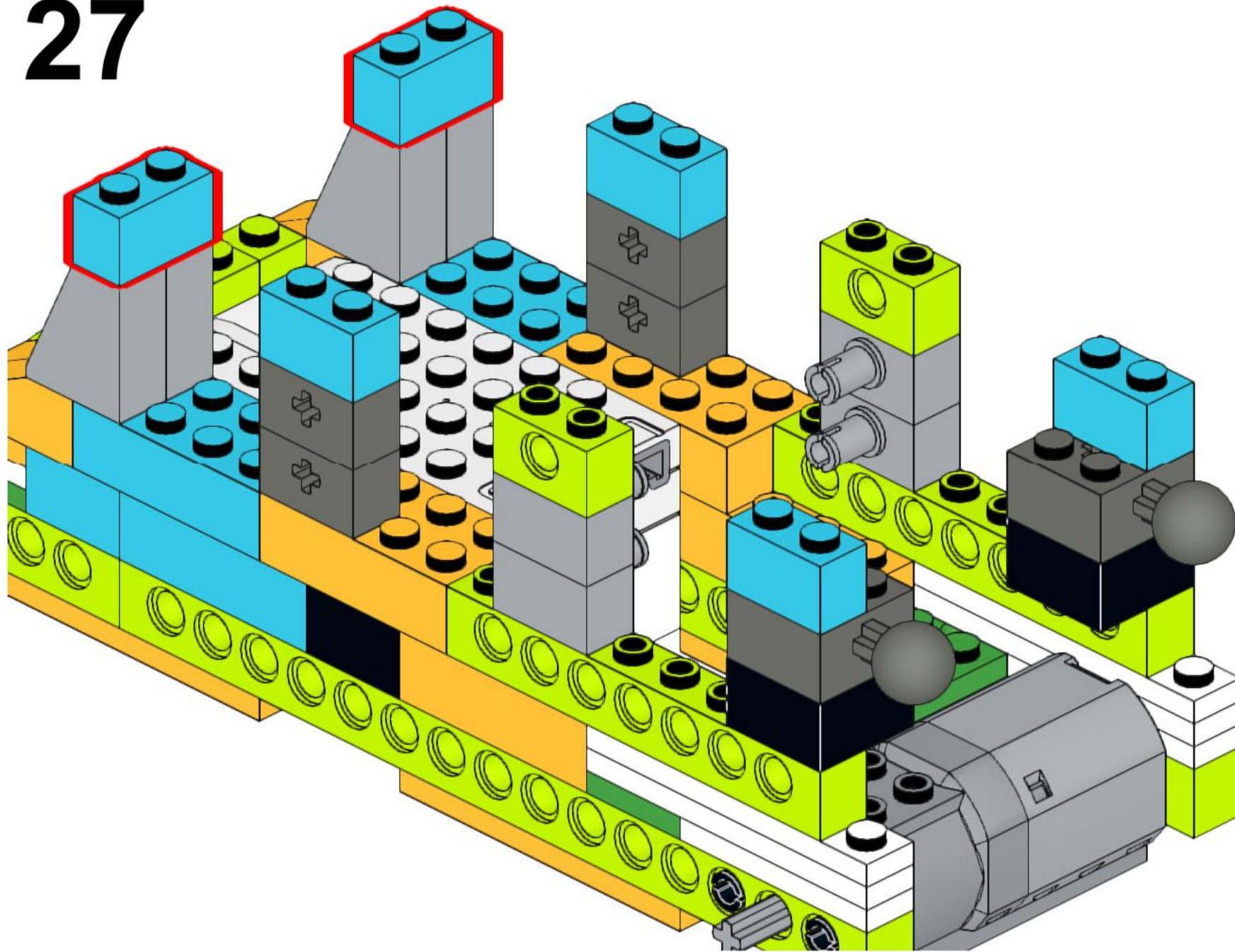

# 28

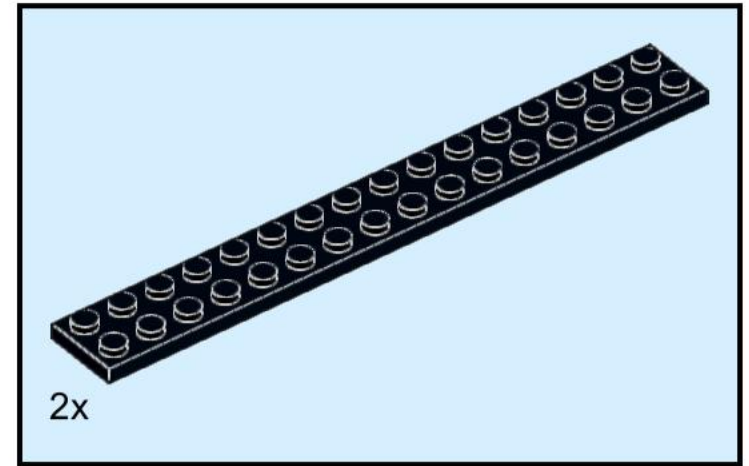
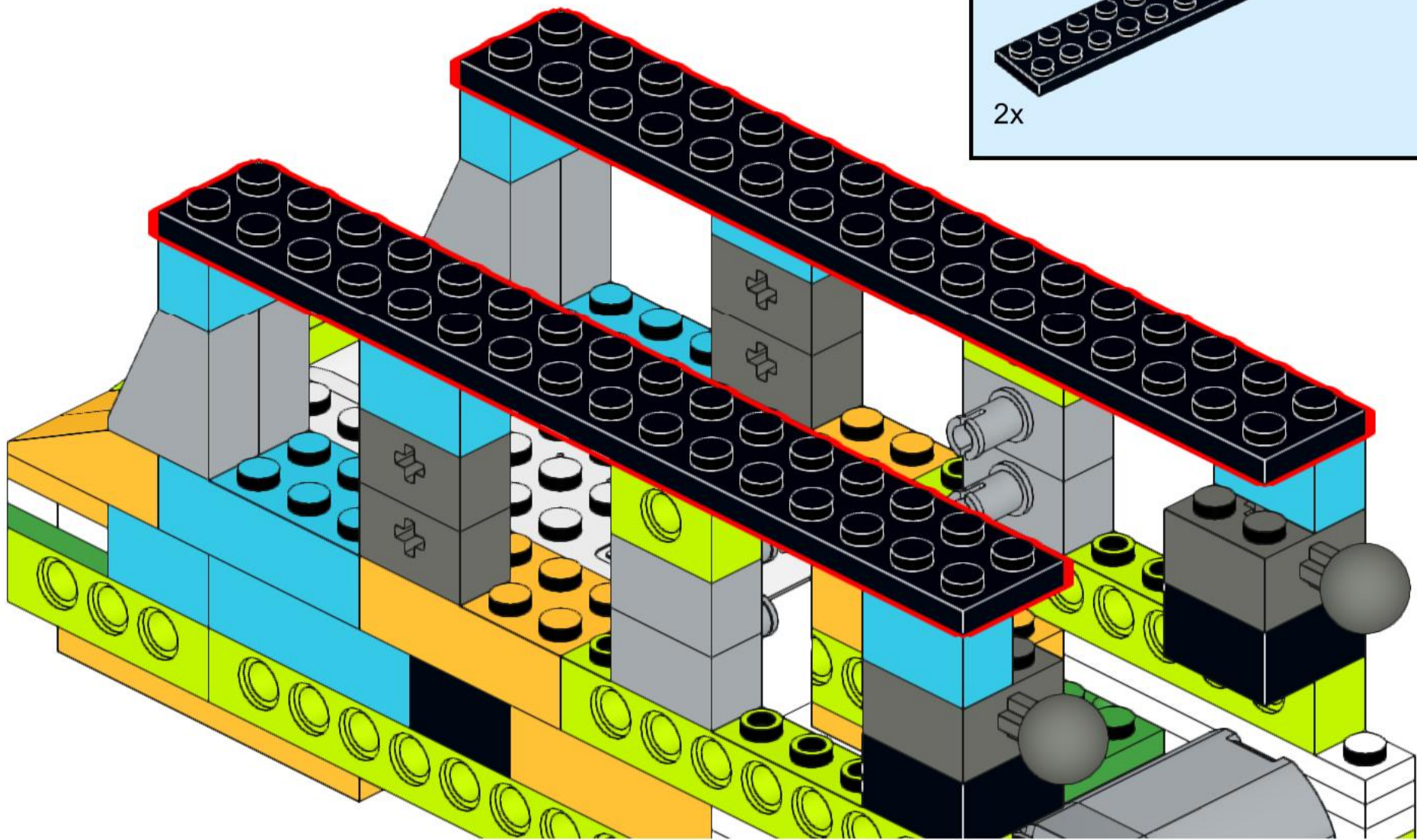

# 29

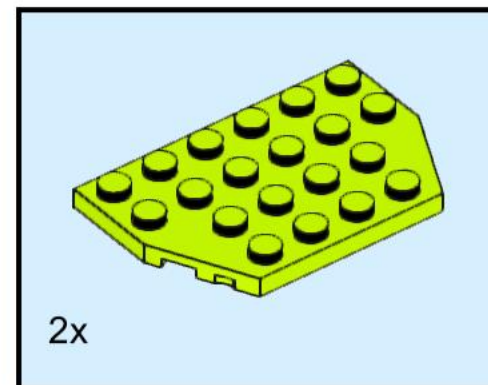
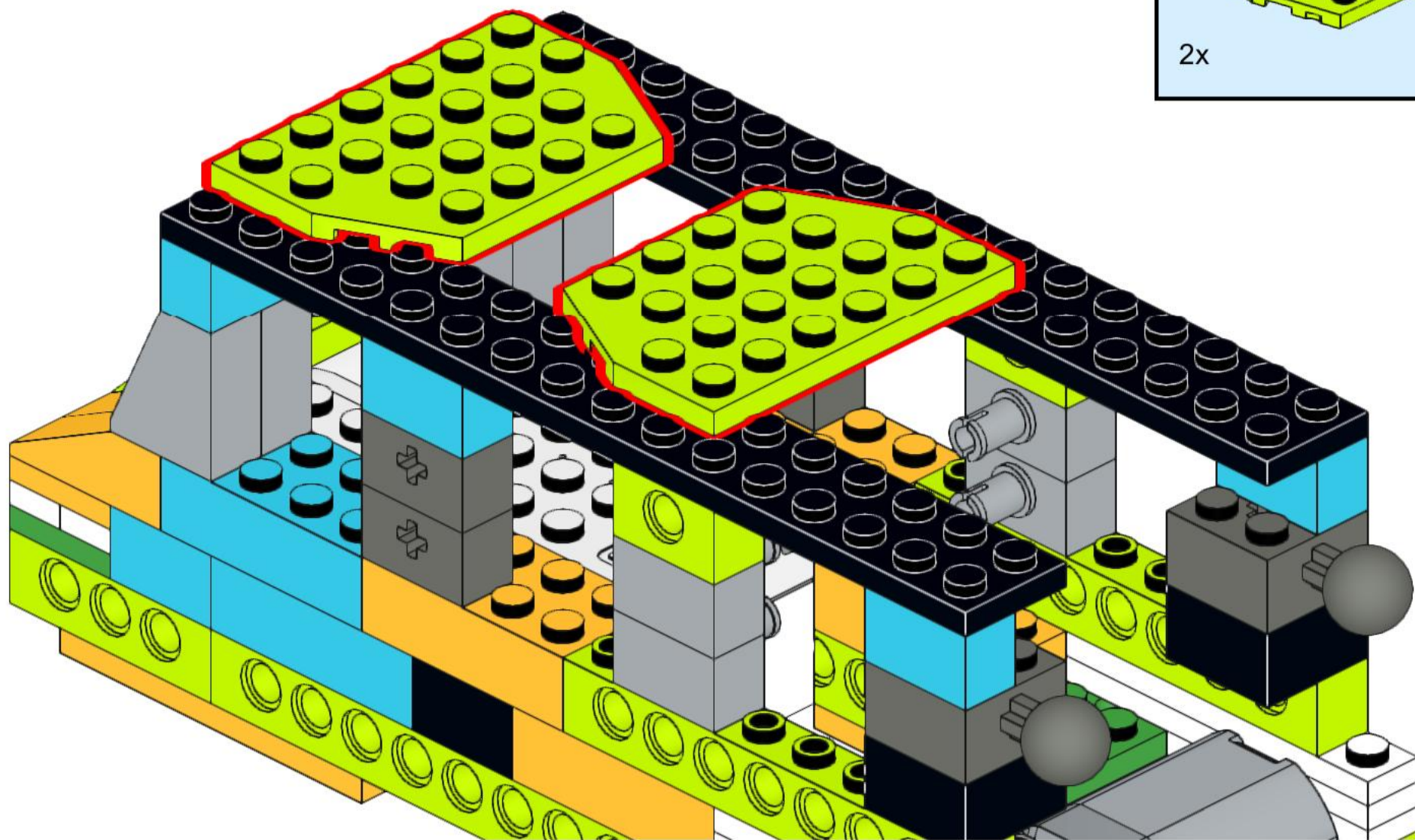

# 30

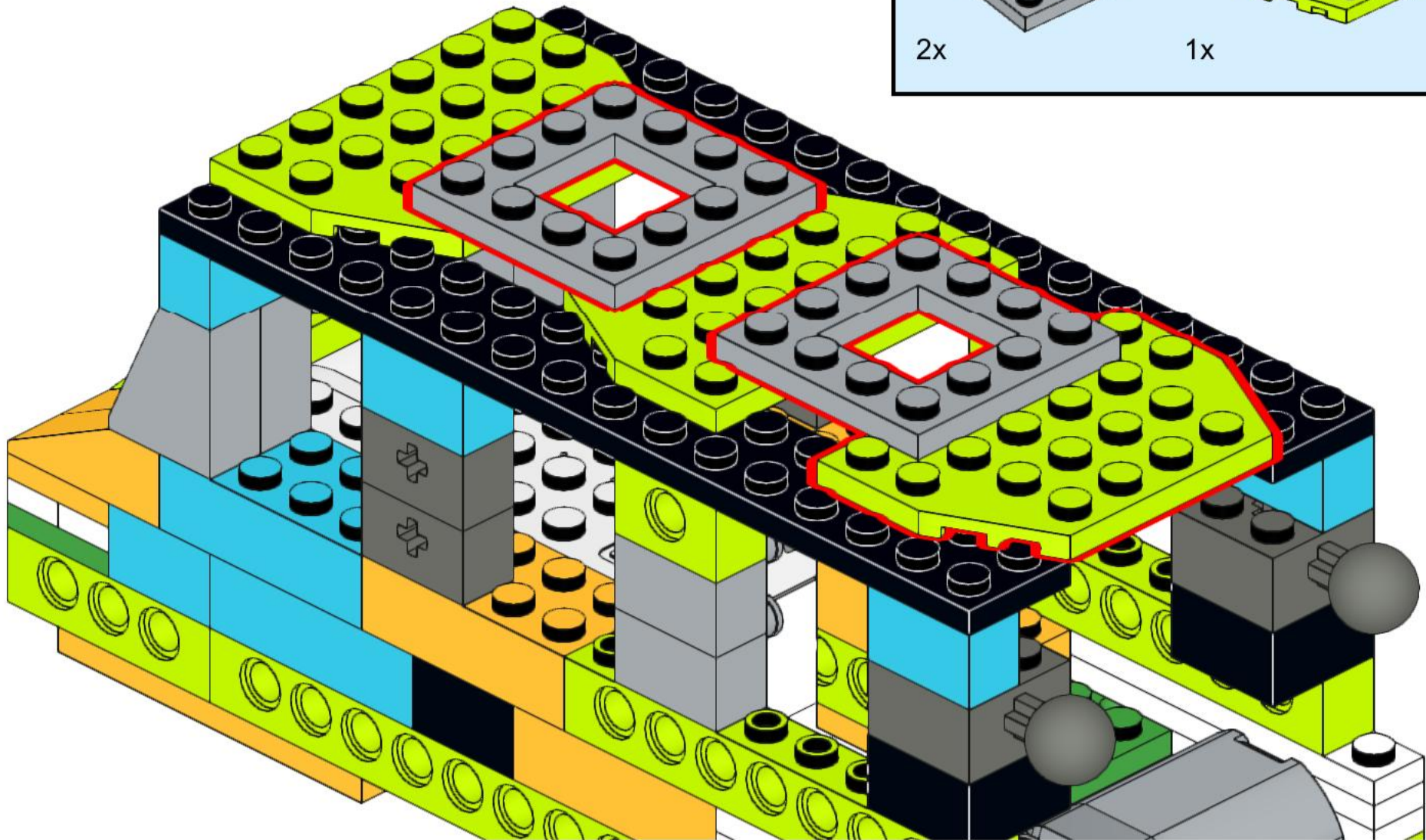
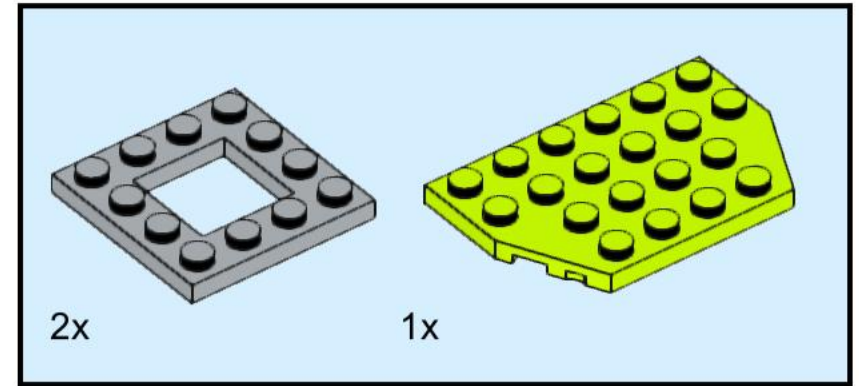

# 31

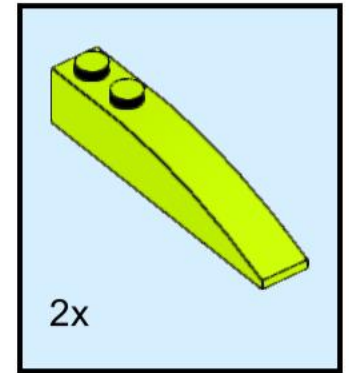
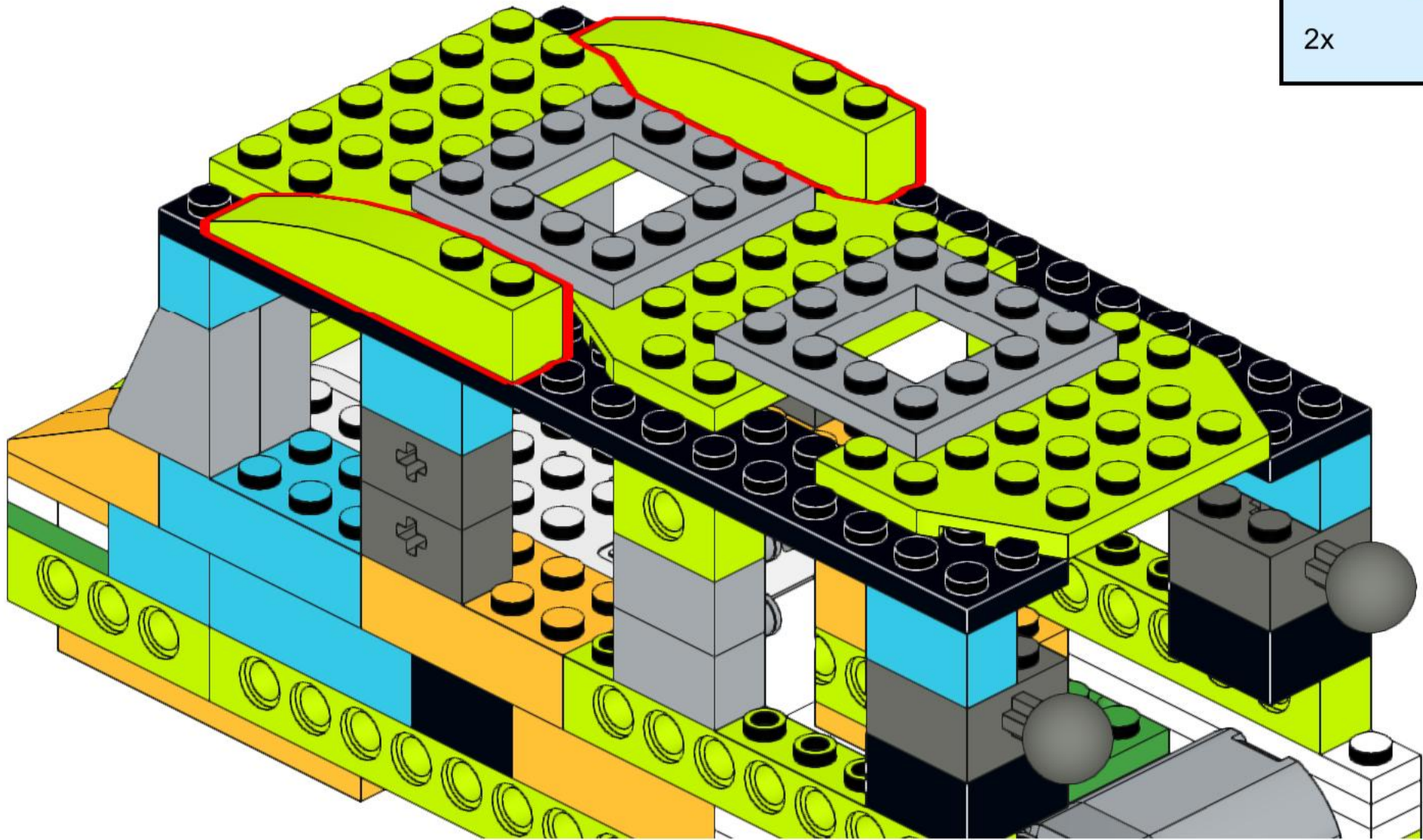

# 32

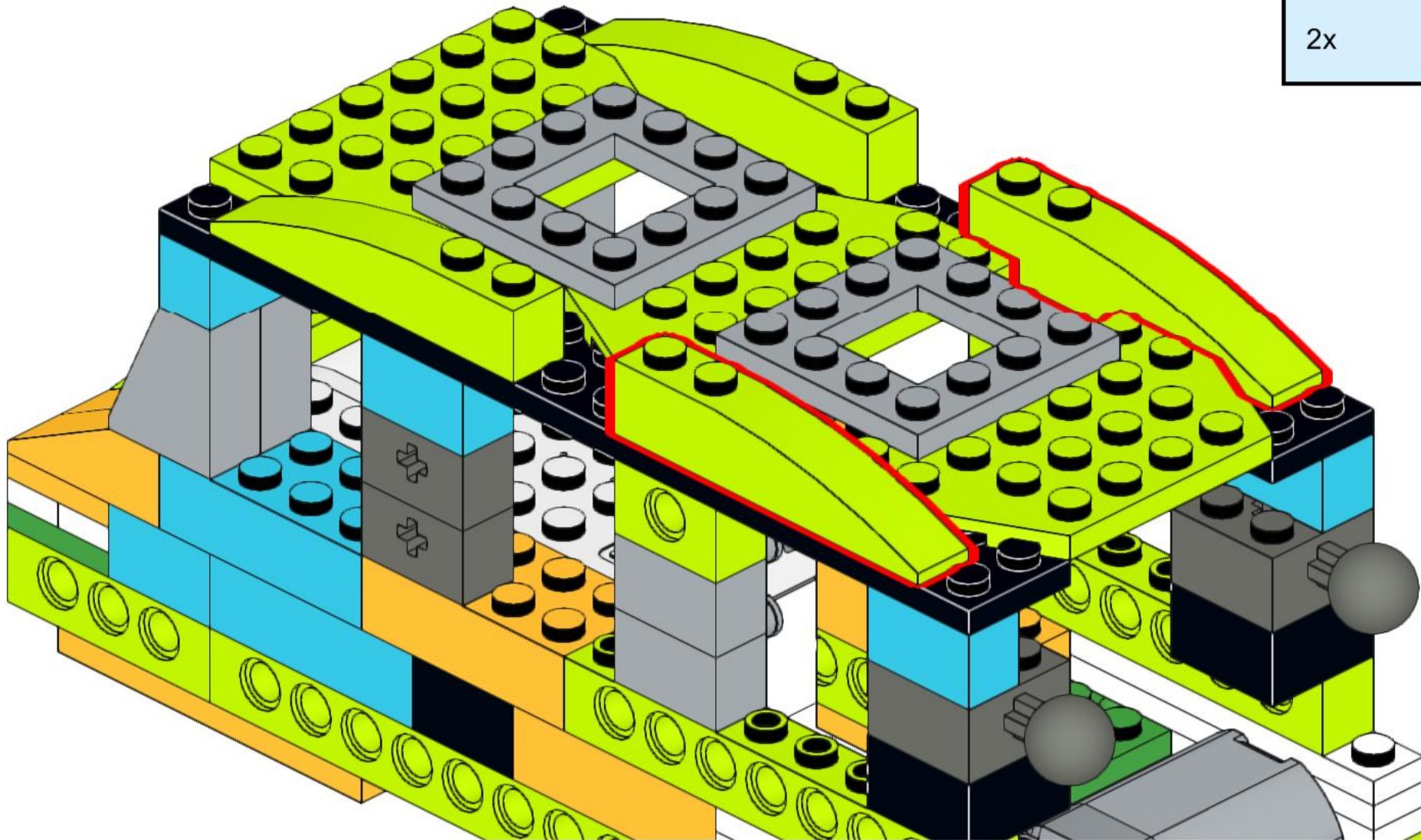
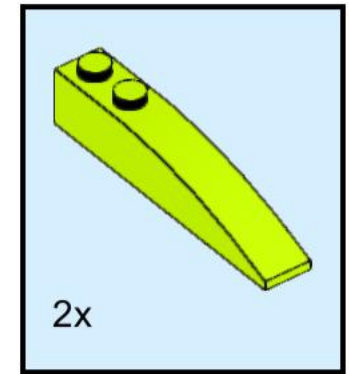



# 33

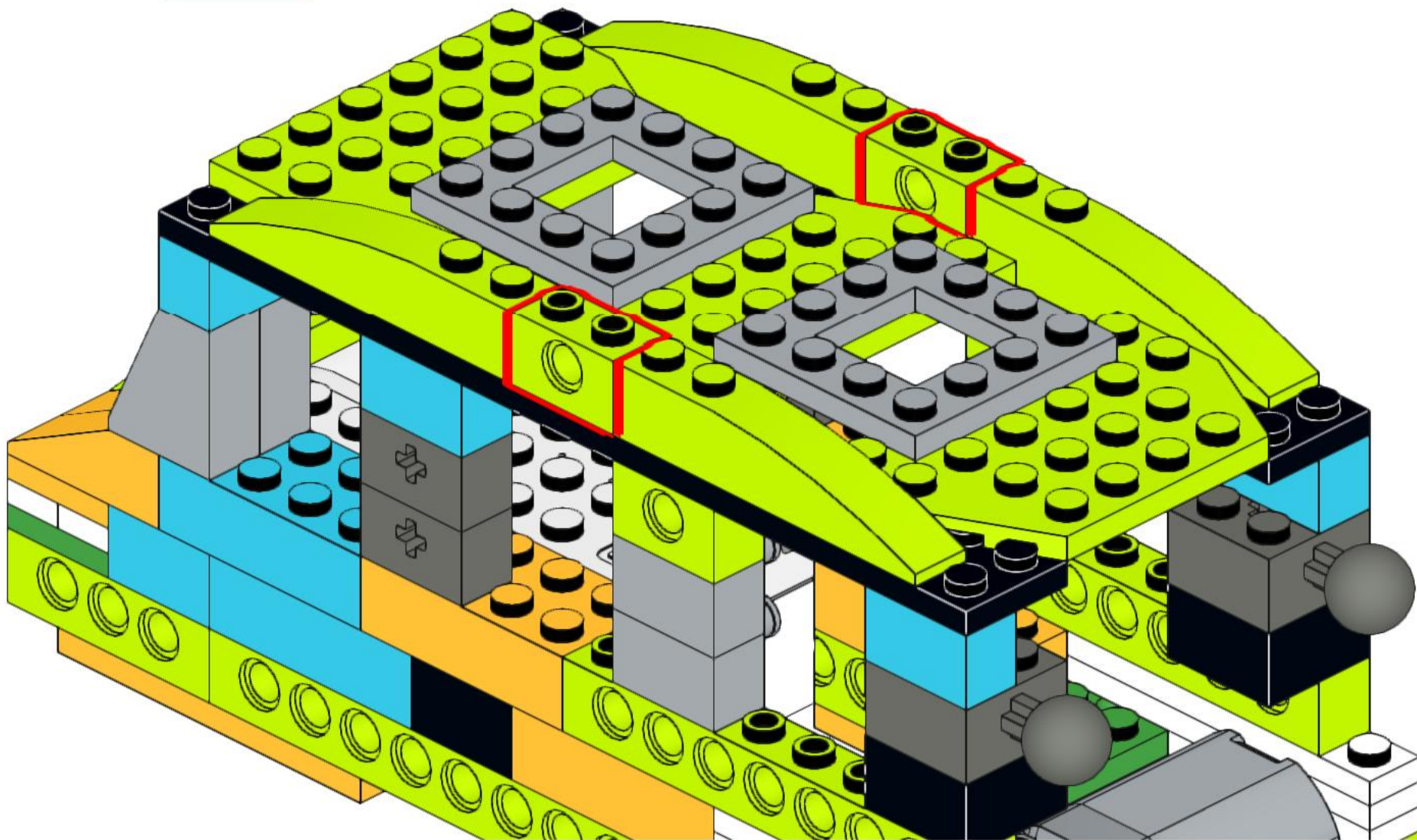
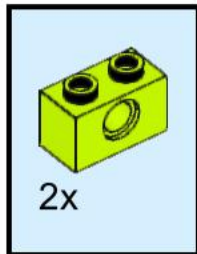

# 34

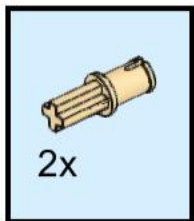
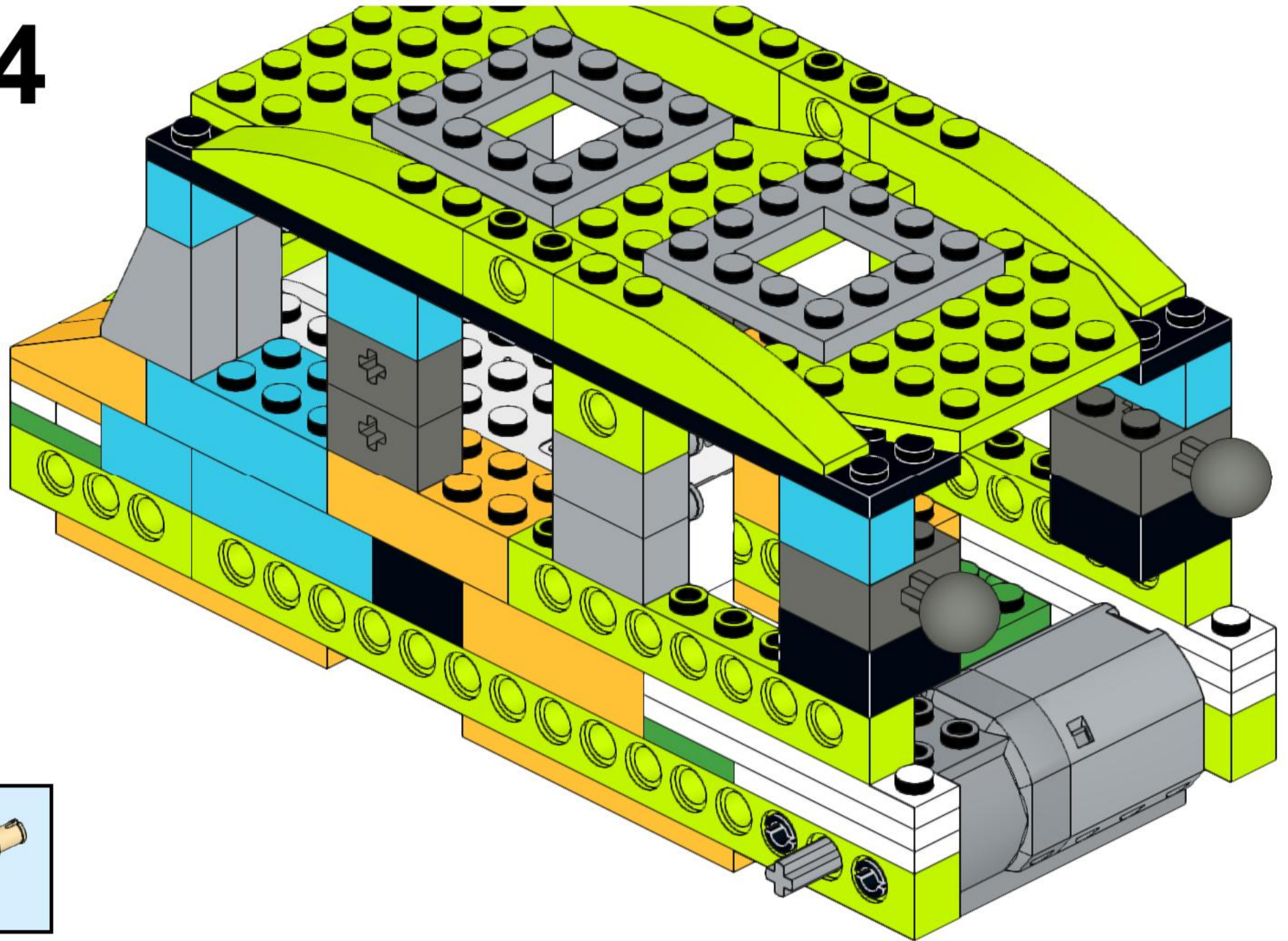

2x

# 35

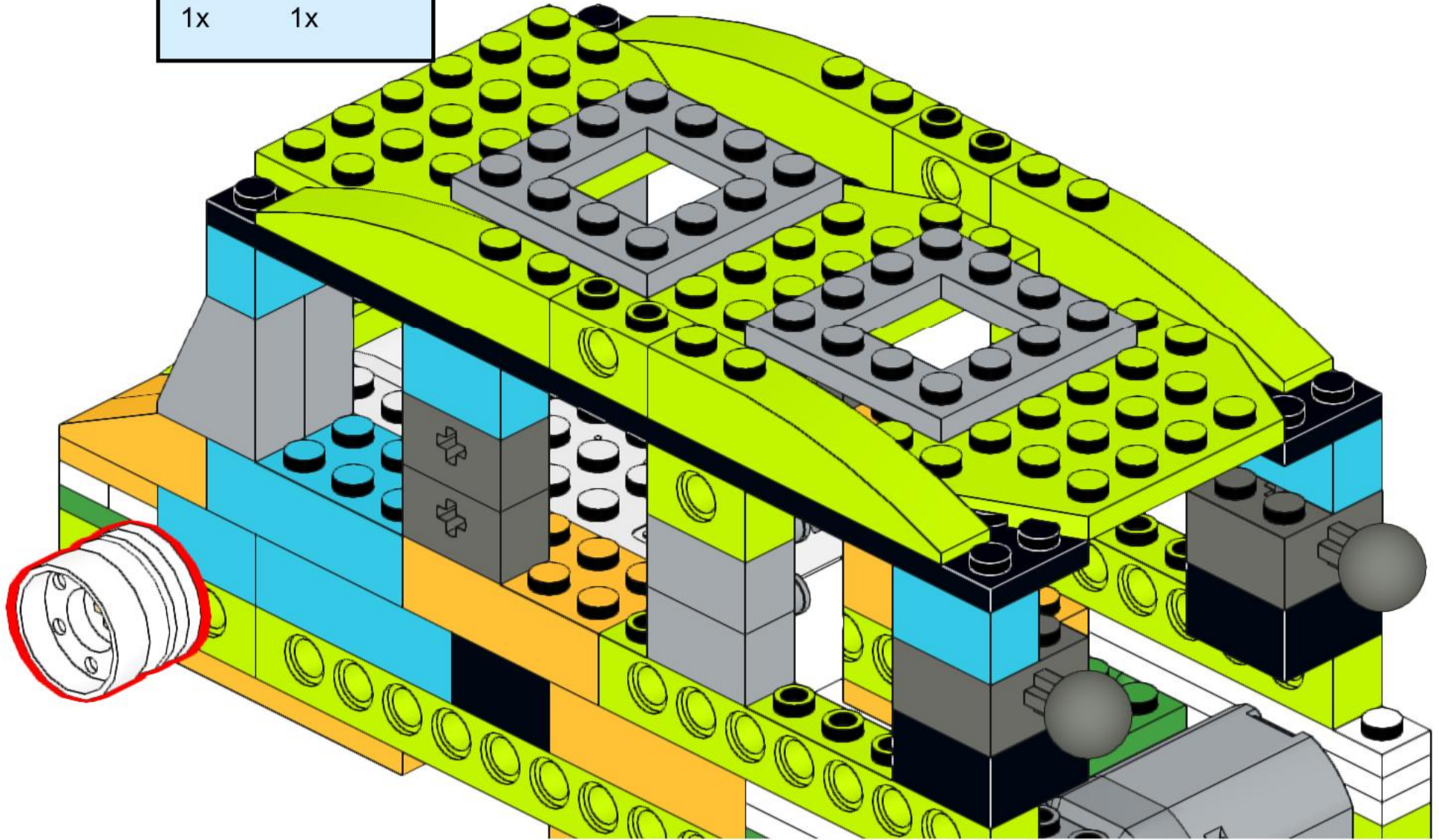
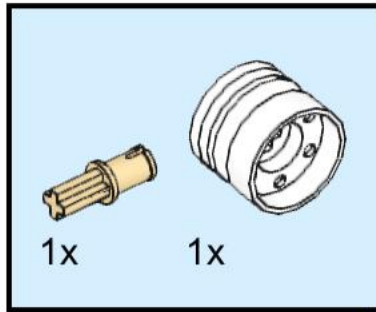

# 36

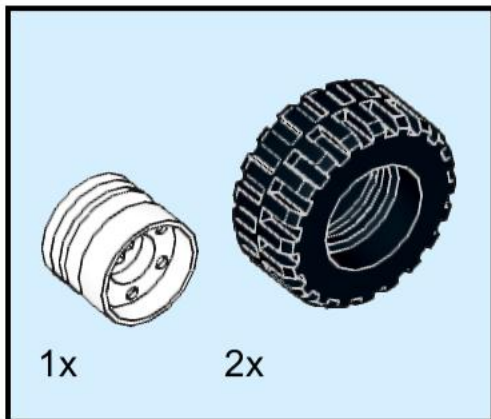
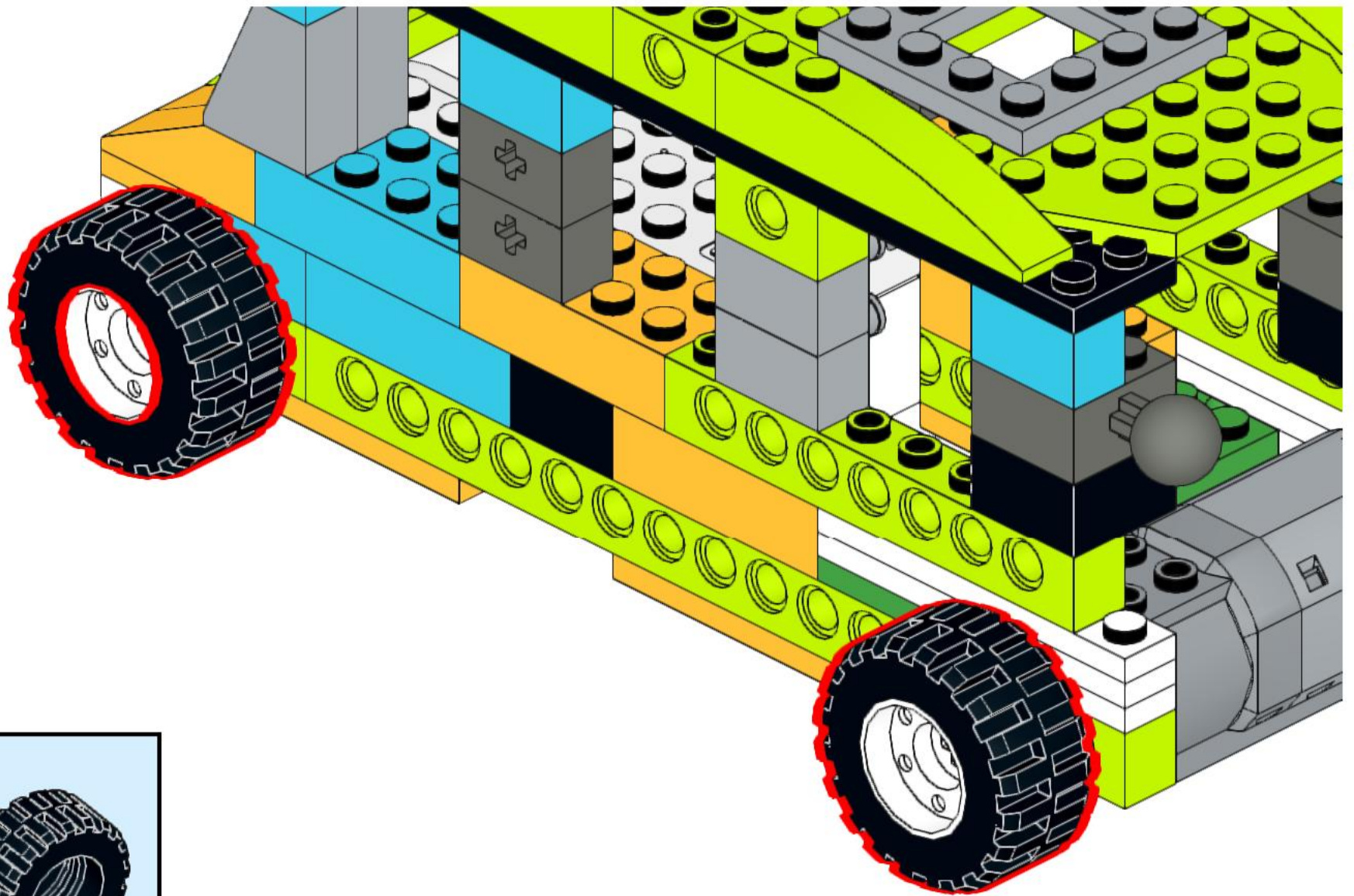

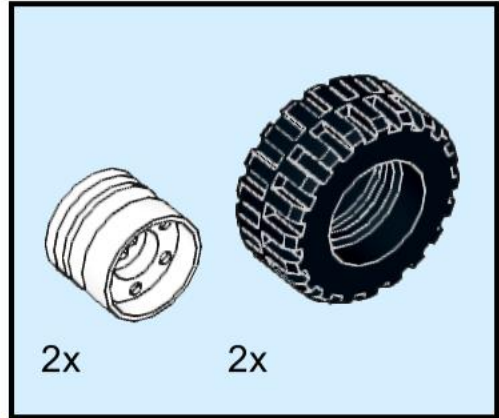
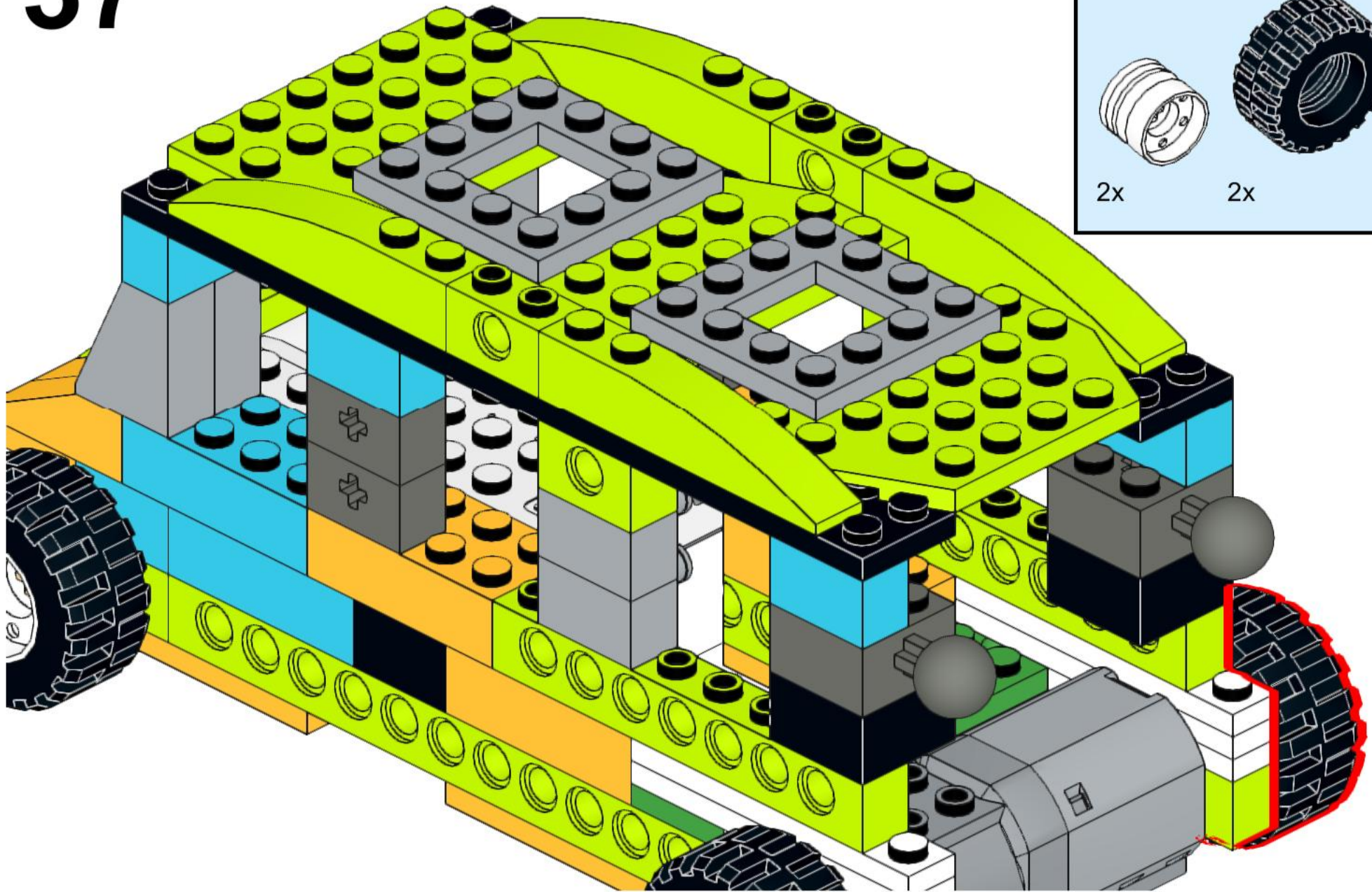

# 37

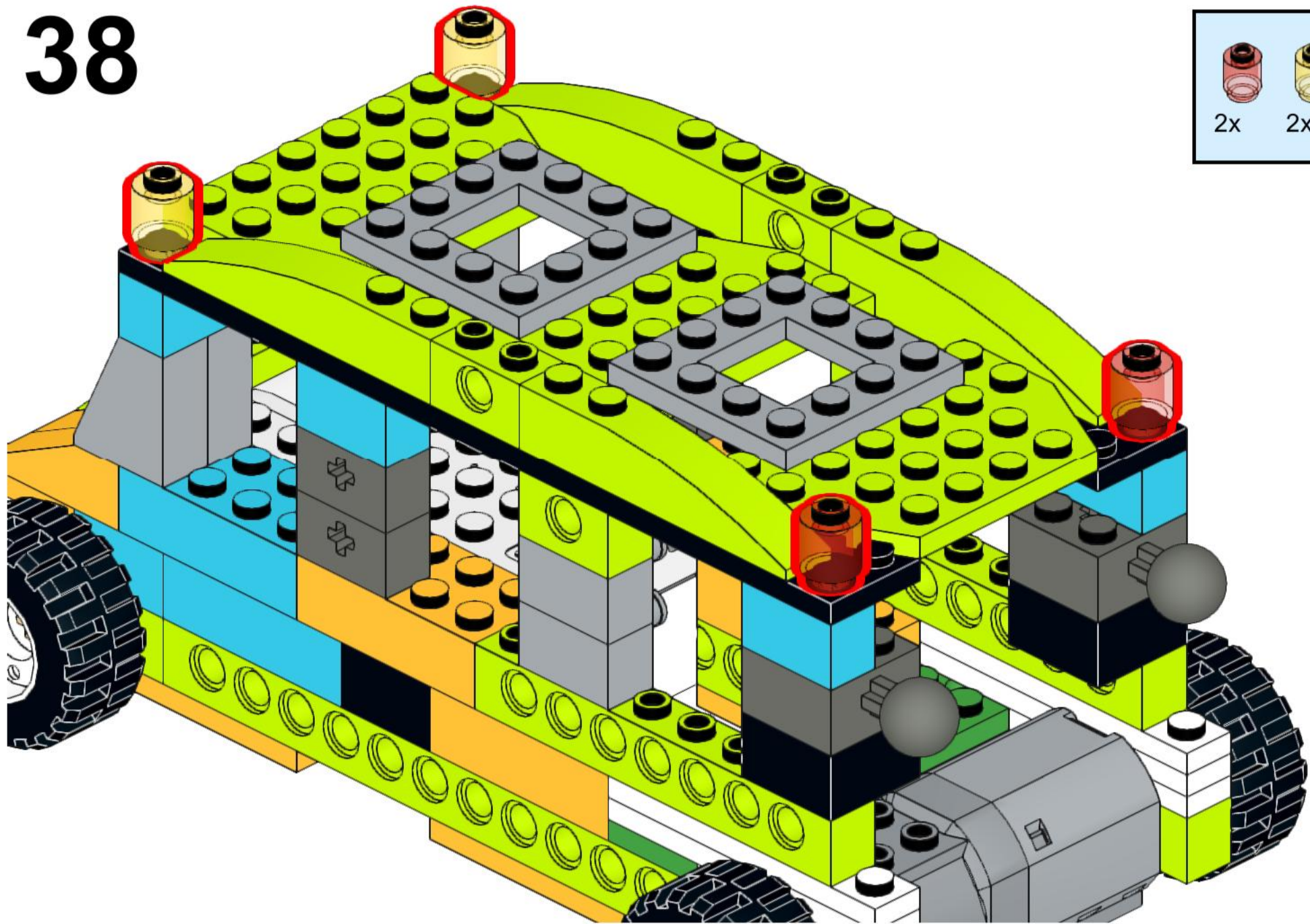

# 38



	
2x	2x

39

