



АВТОБУС

Авто́бус (сокращение от автомобиль-
омнибус)

АВТОБУС



Омнибус — многоместная повозка на конной тяге, вид городского общественного транспорта, характерный для второй половины XIX века.

АВТОБУС



Авто́бус — безрельсовое механическое моторное транспортное средство, технически предназначенное для перевозки девяти и более пассажиров и способное маневрировать на дороге, приводимое в движение источником энергии, запасённым или производимым из топлива, хранящегося на борту.

1

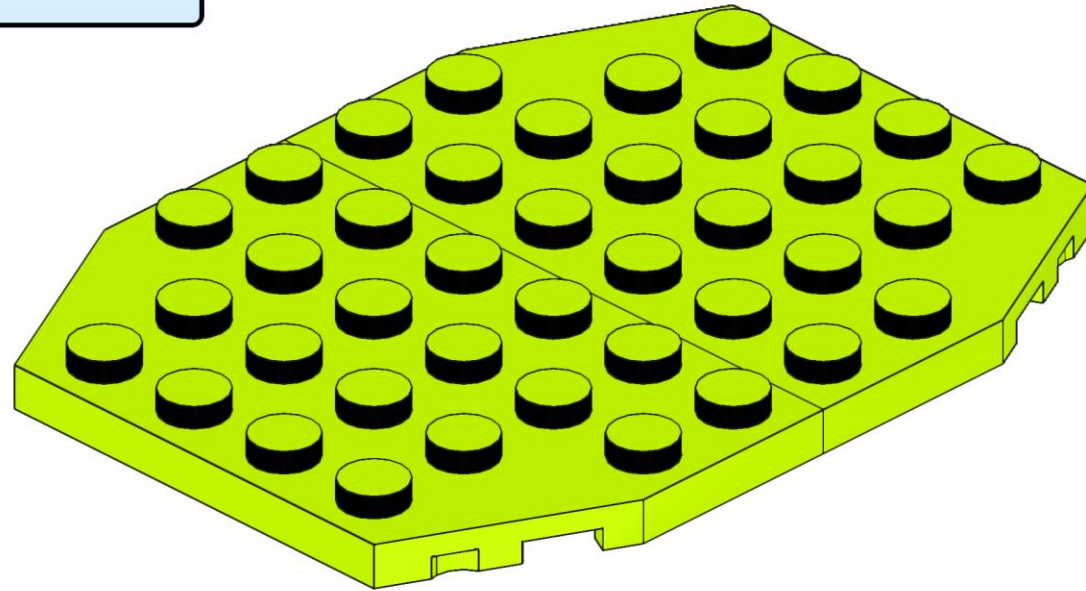
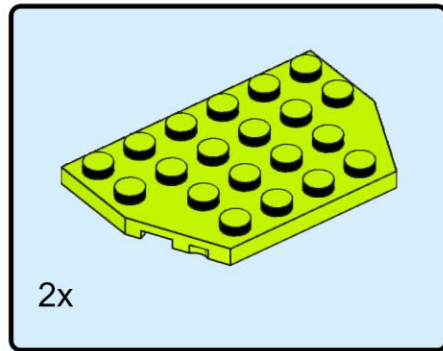

2

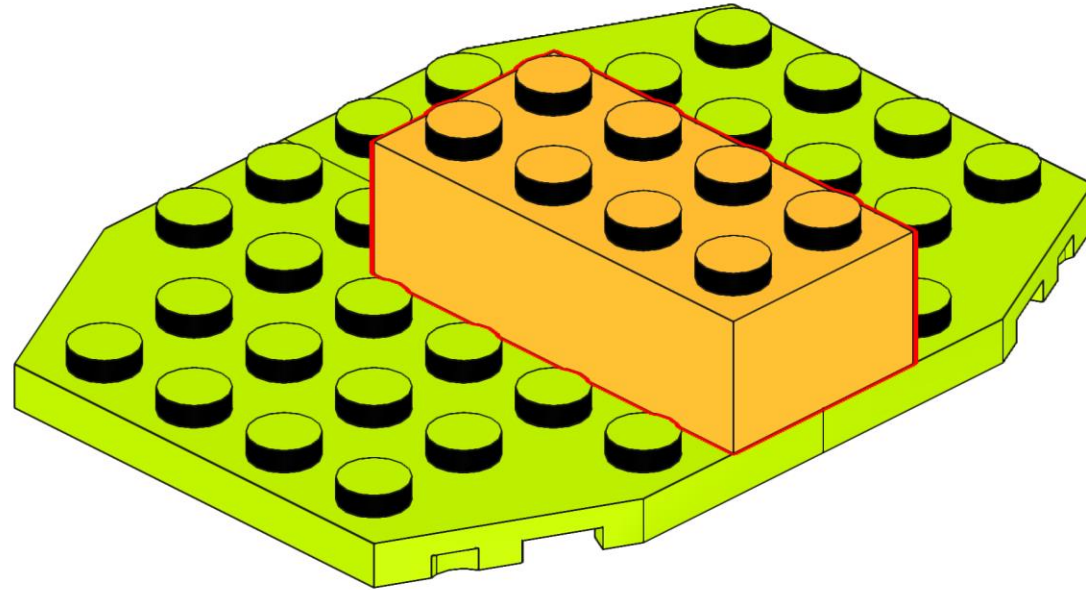
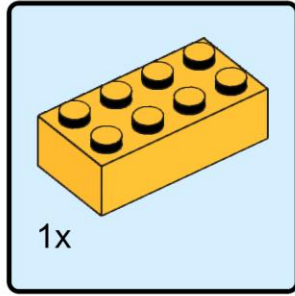

3

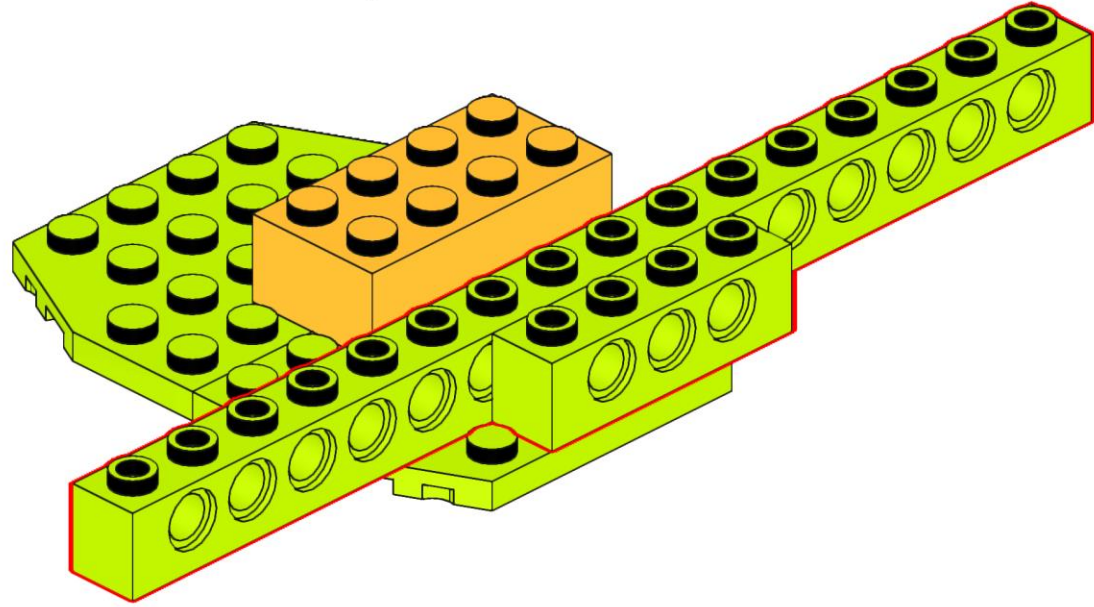
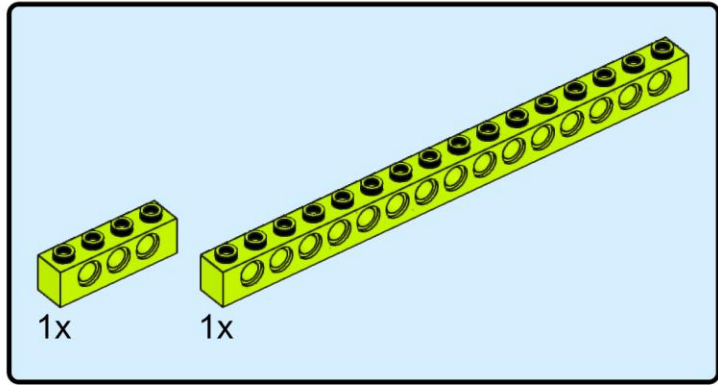

4

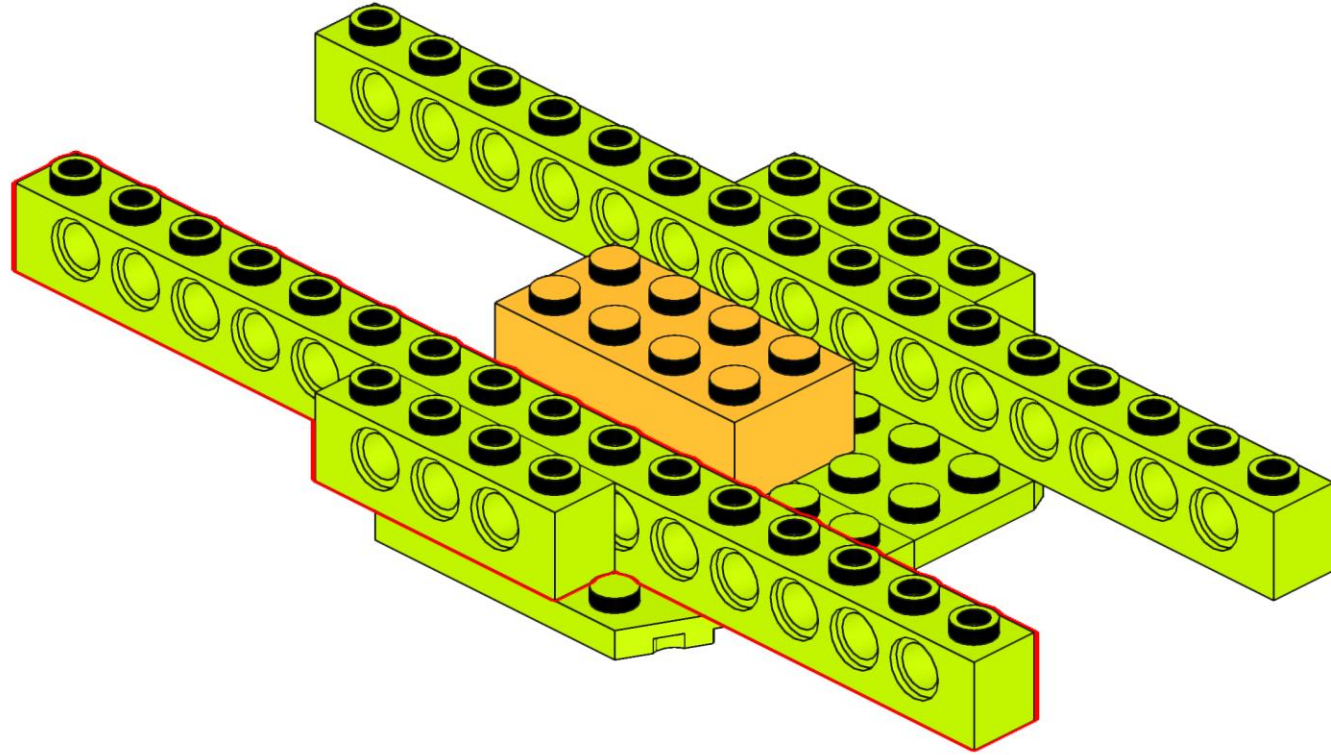
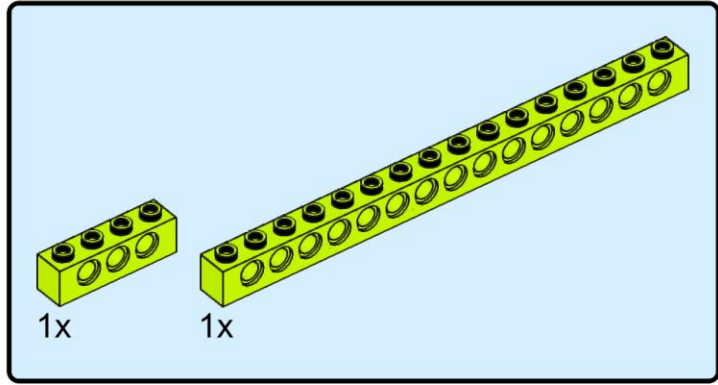

5

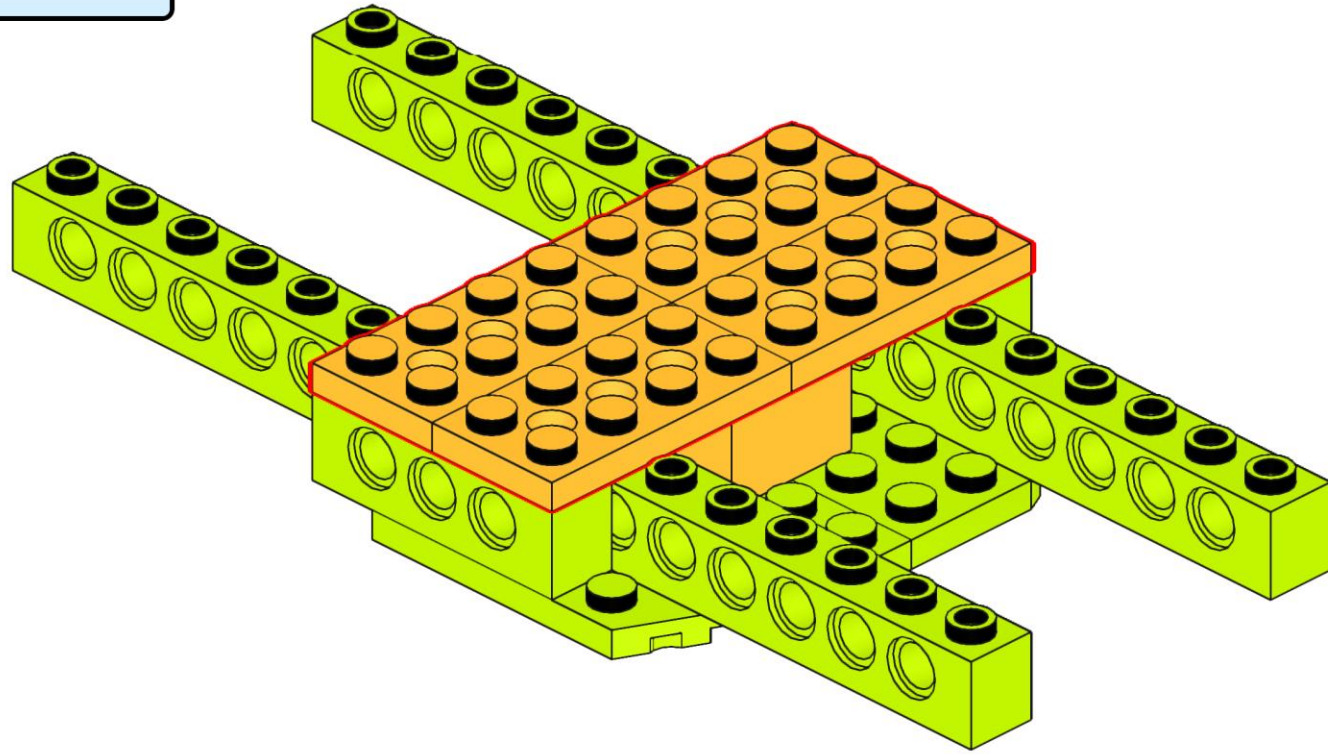
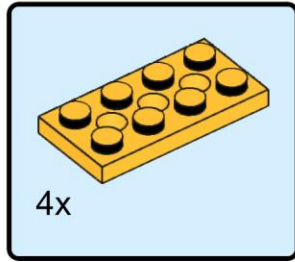

6

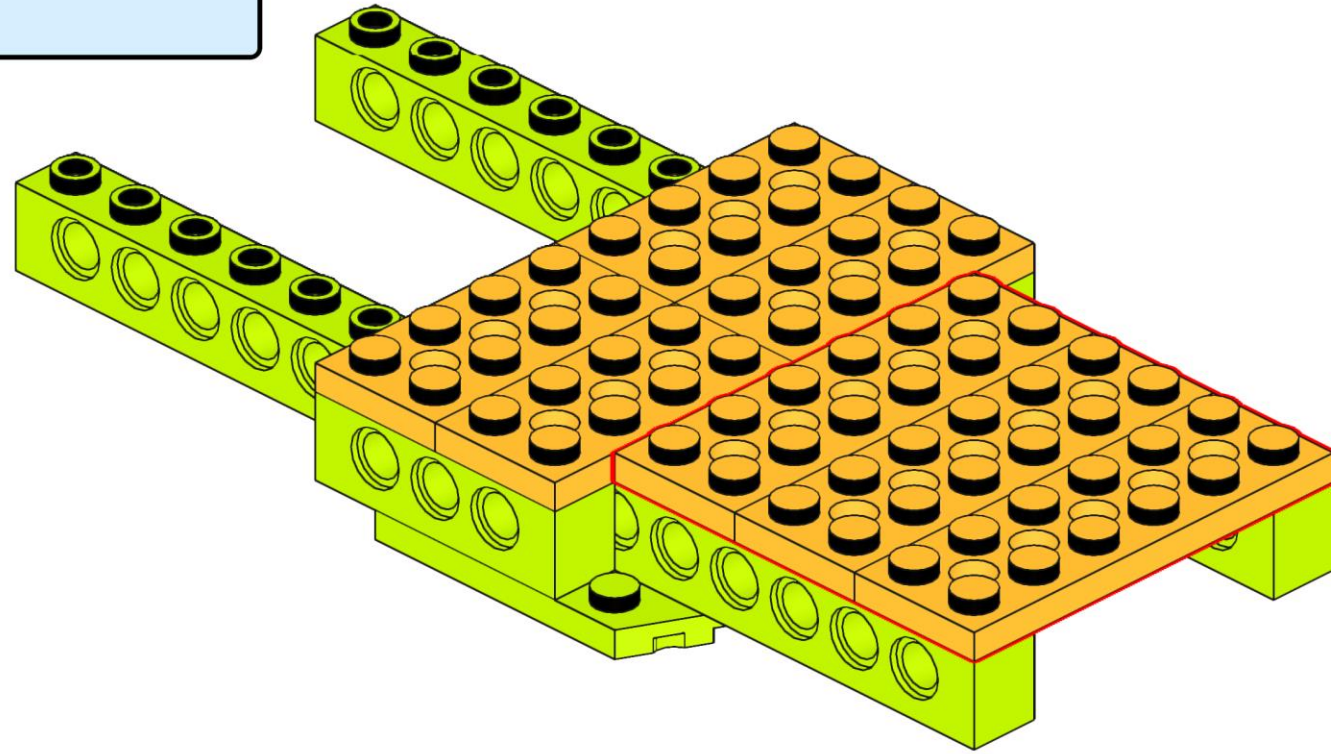
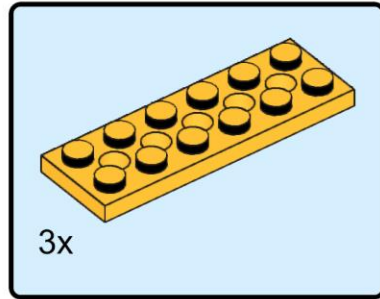

7

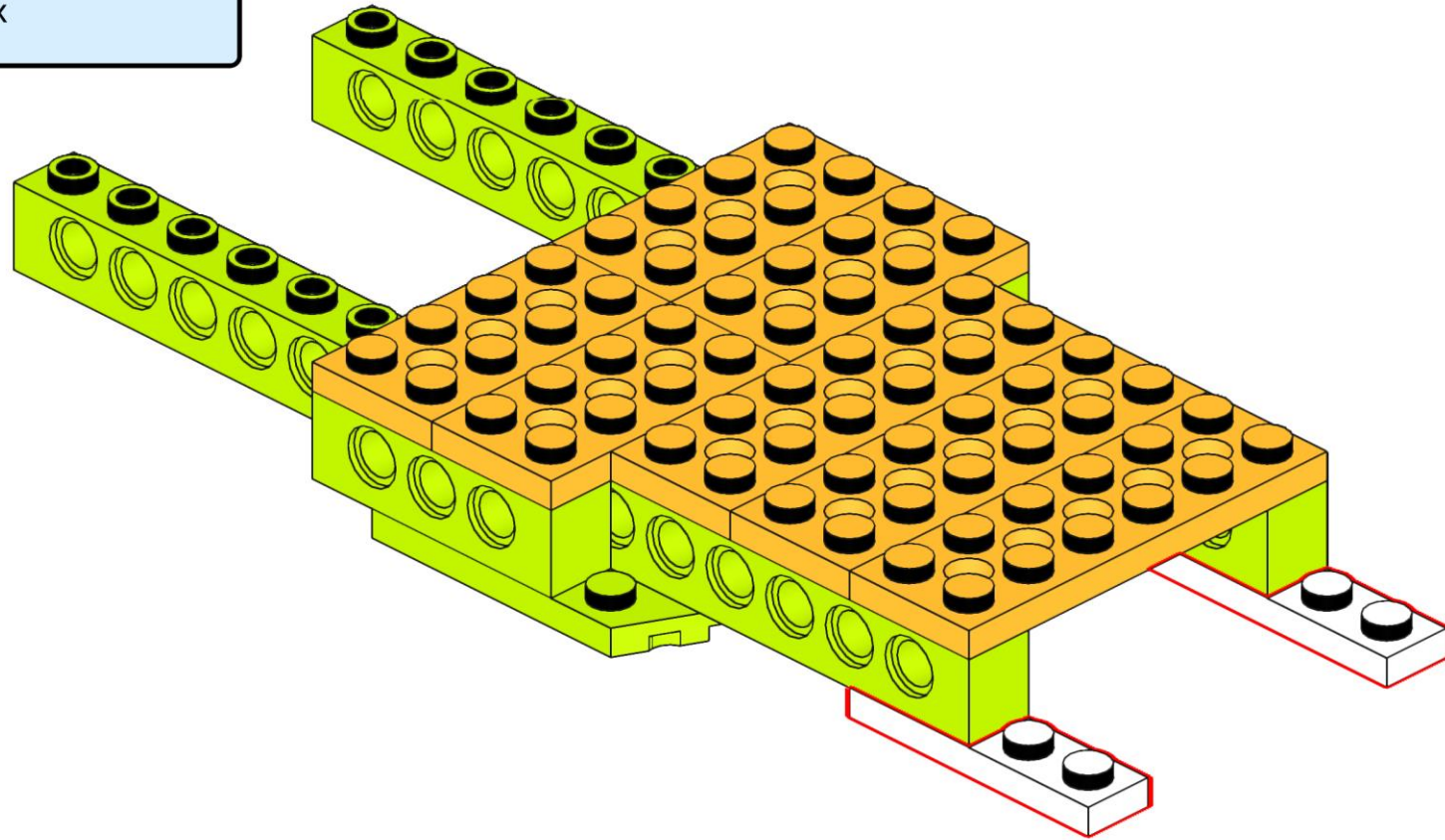
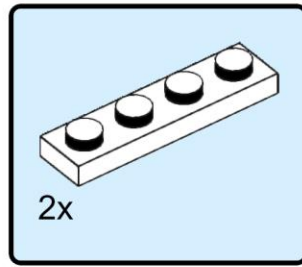

8

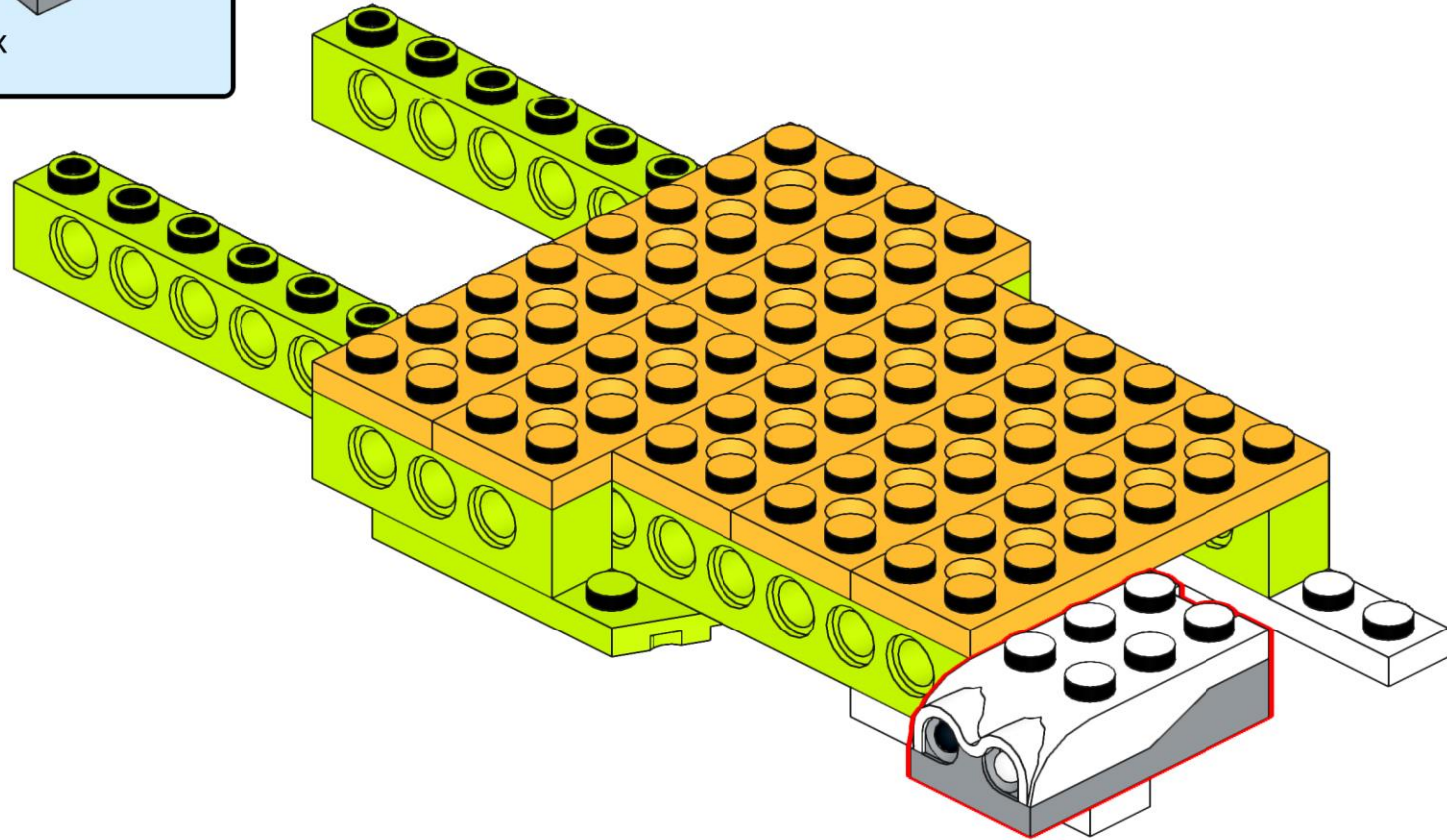
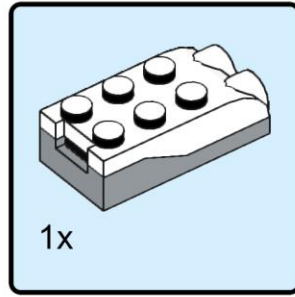

9

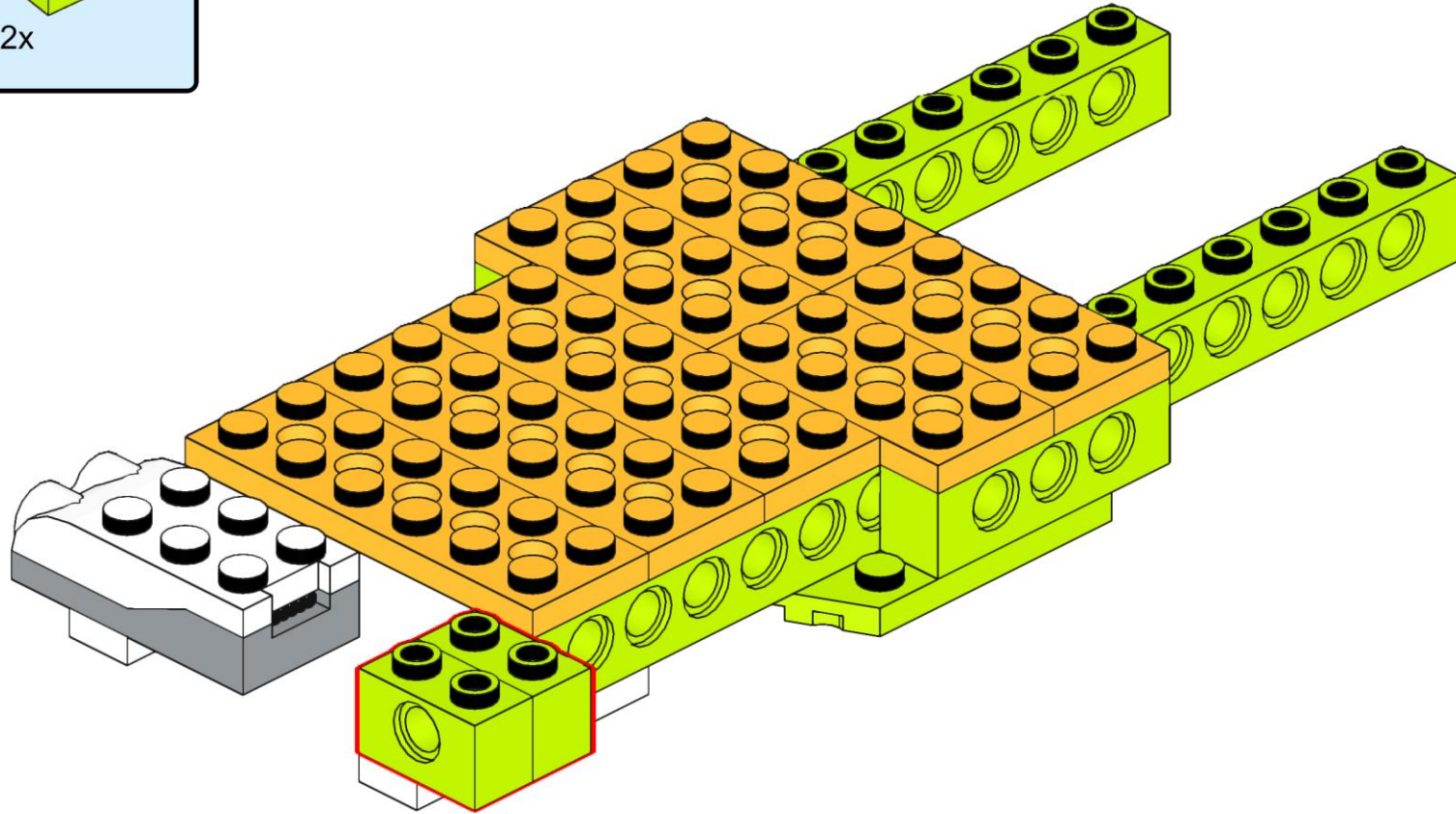
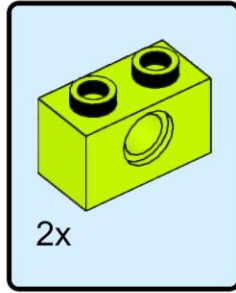

10

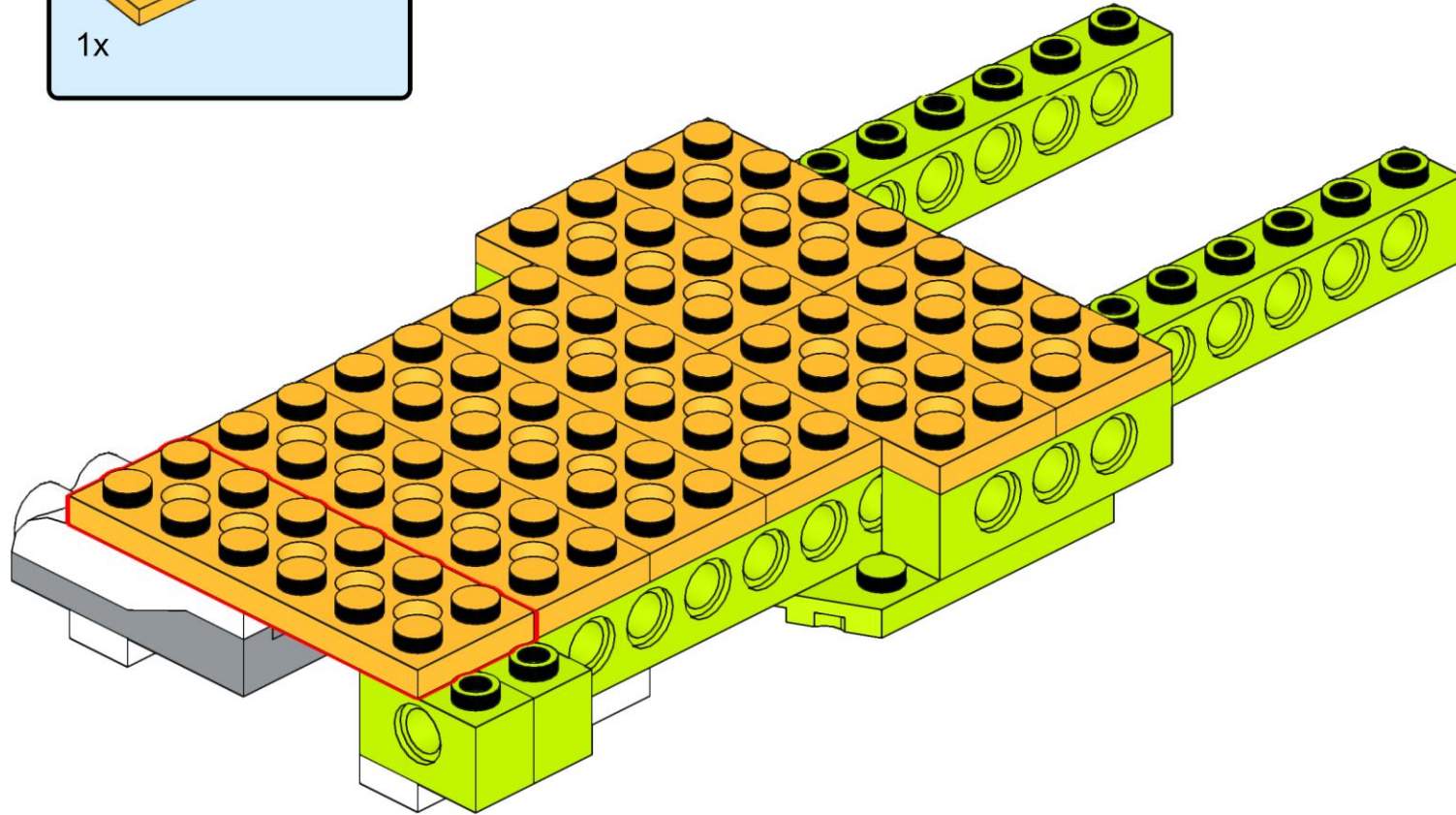
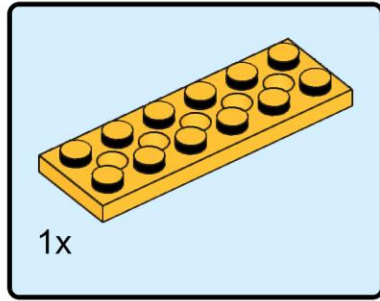

11

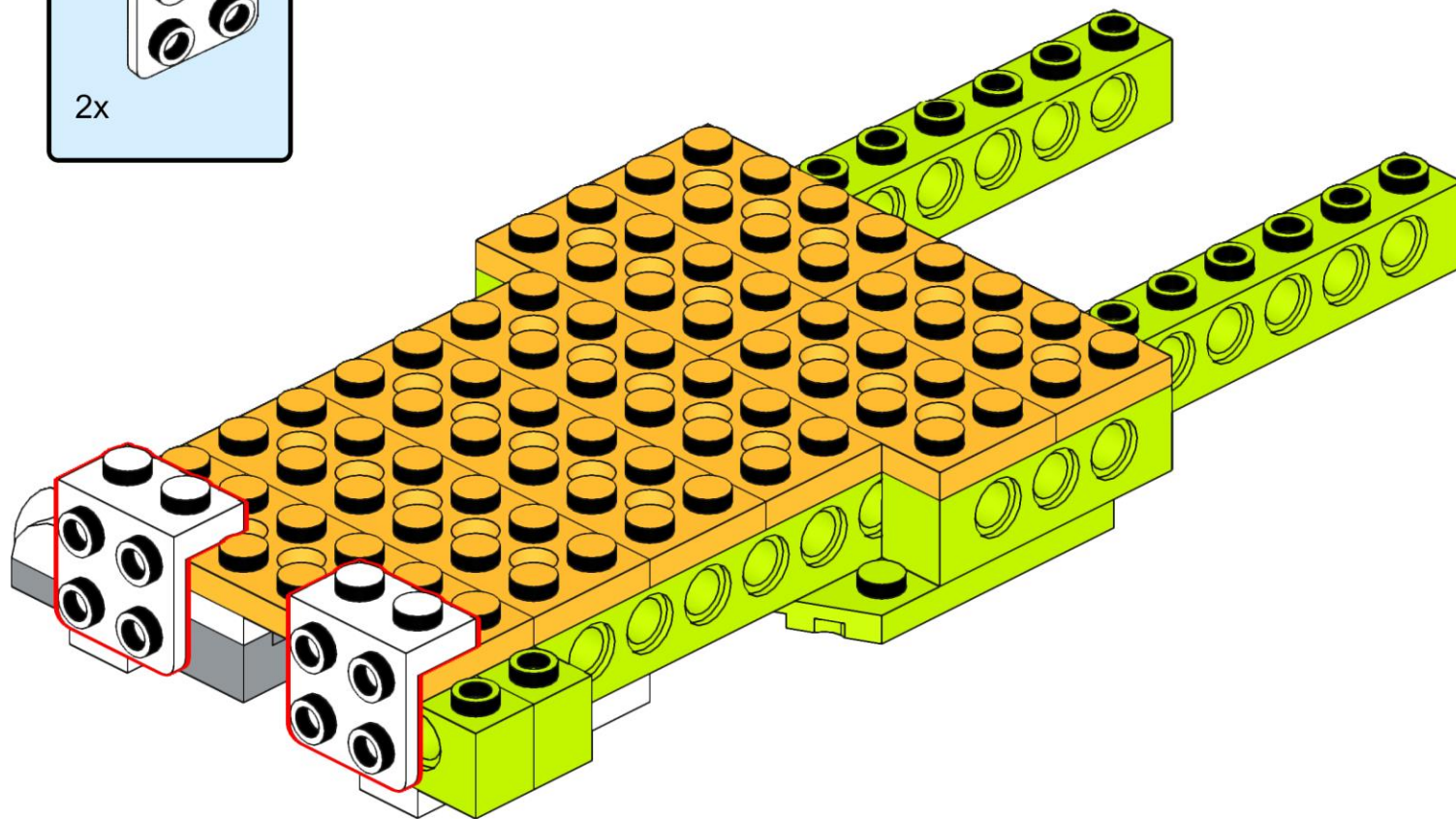
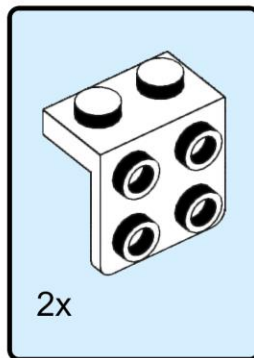

12

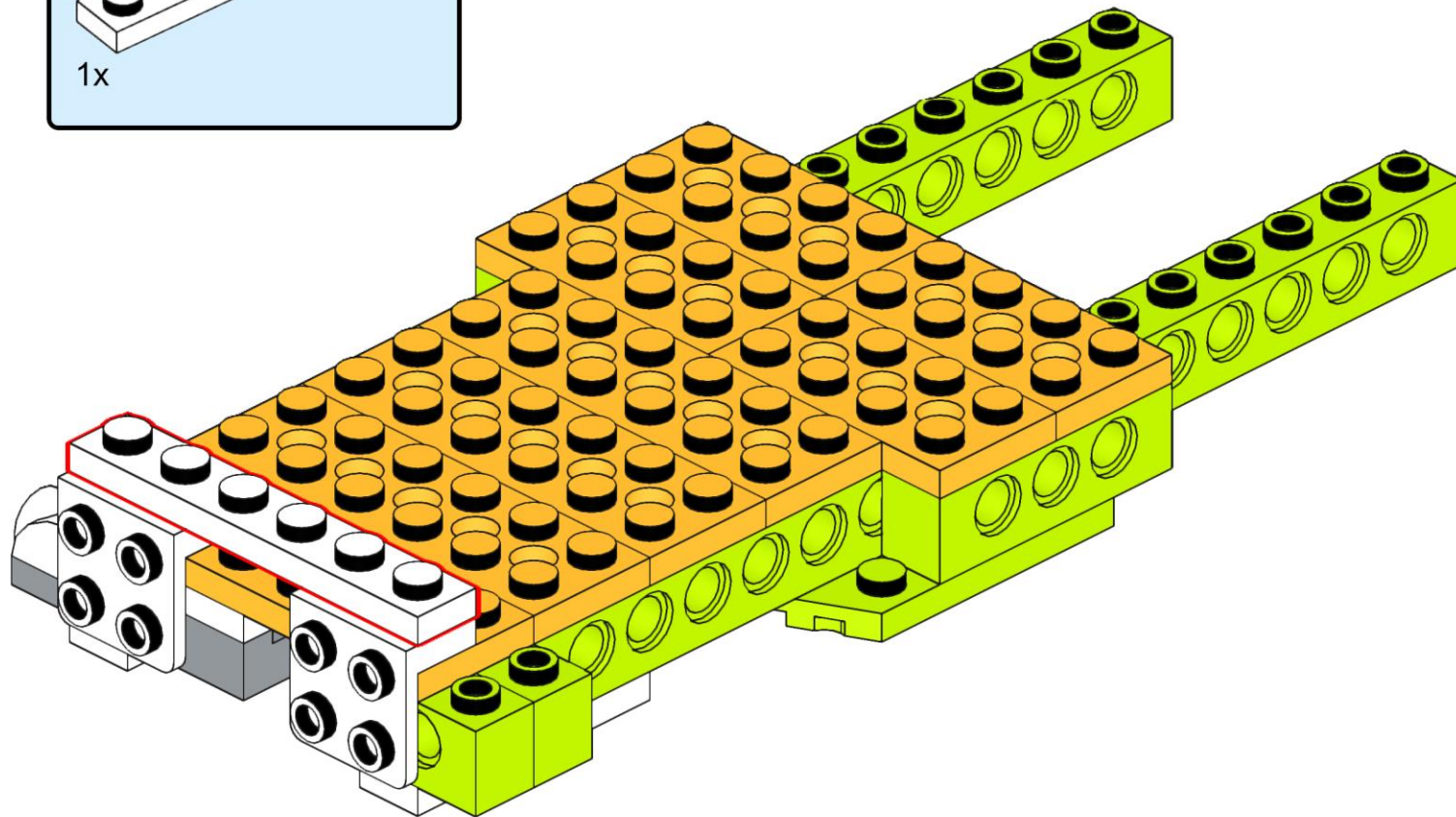
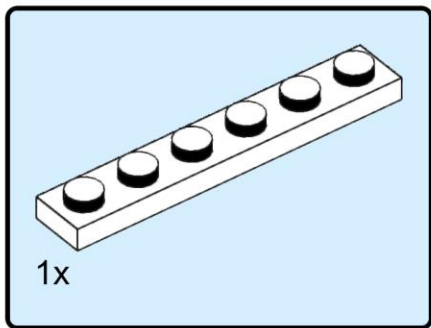

13

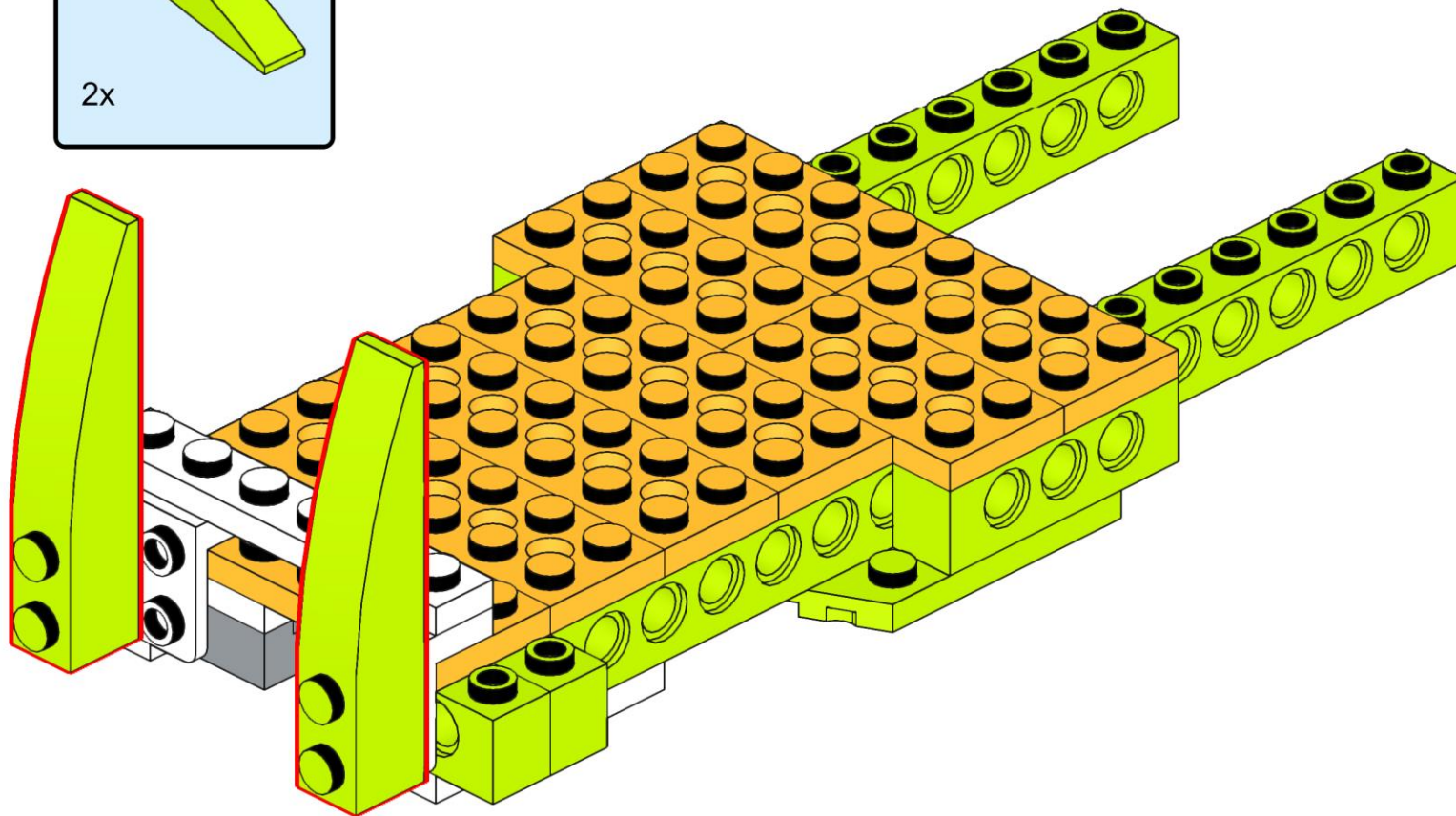
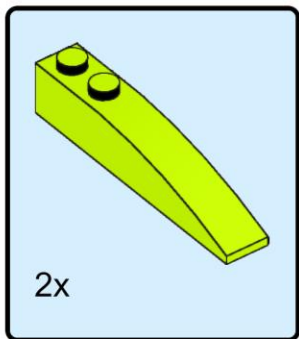

14

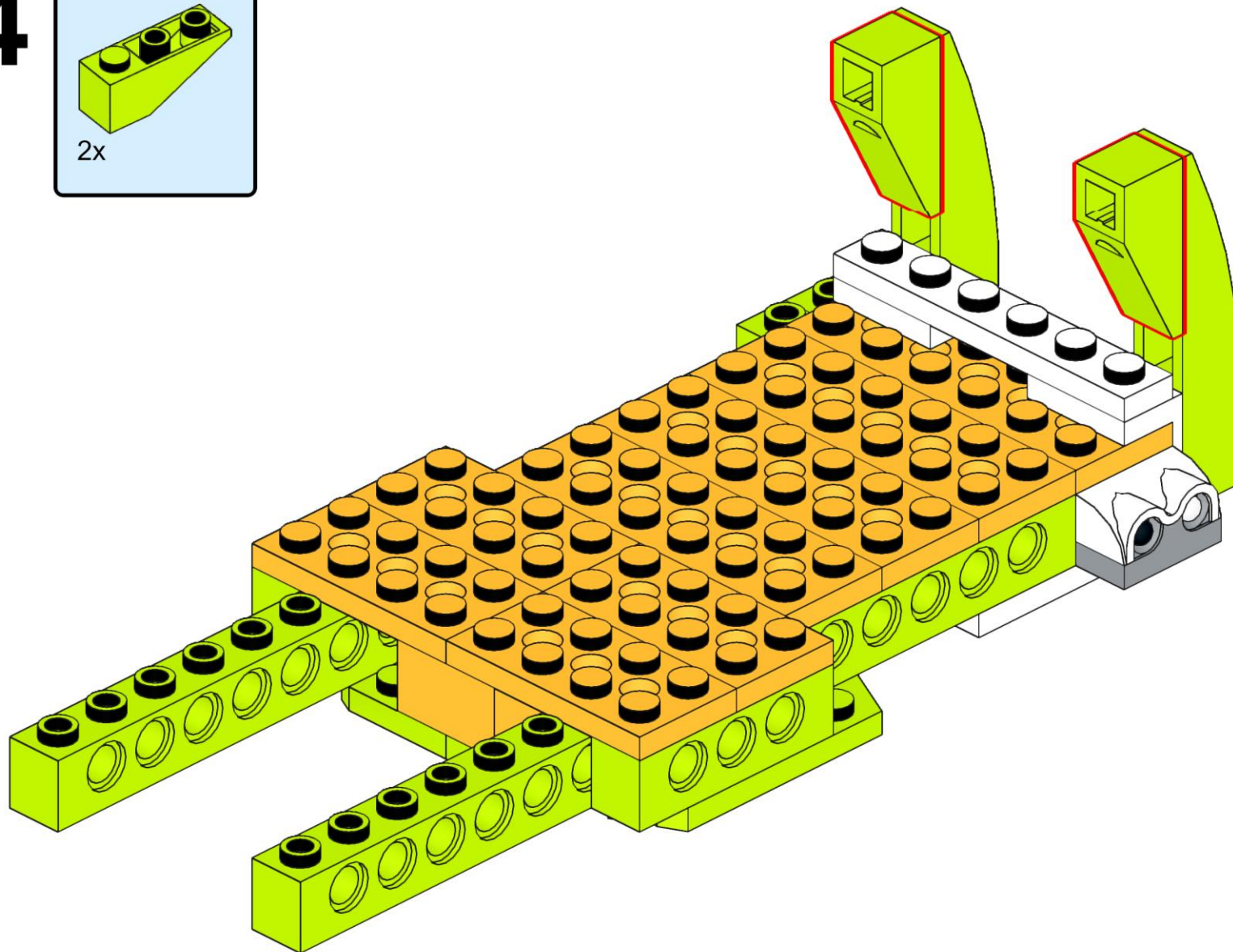
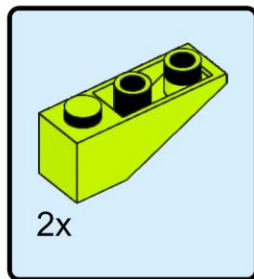

15

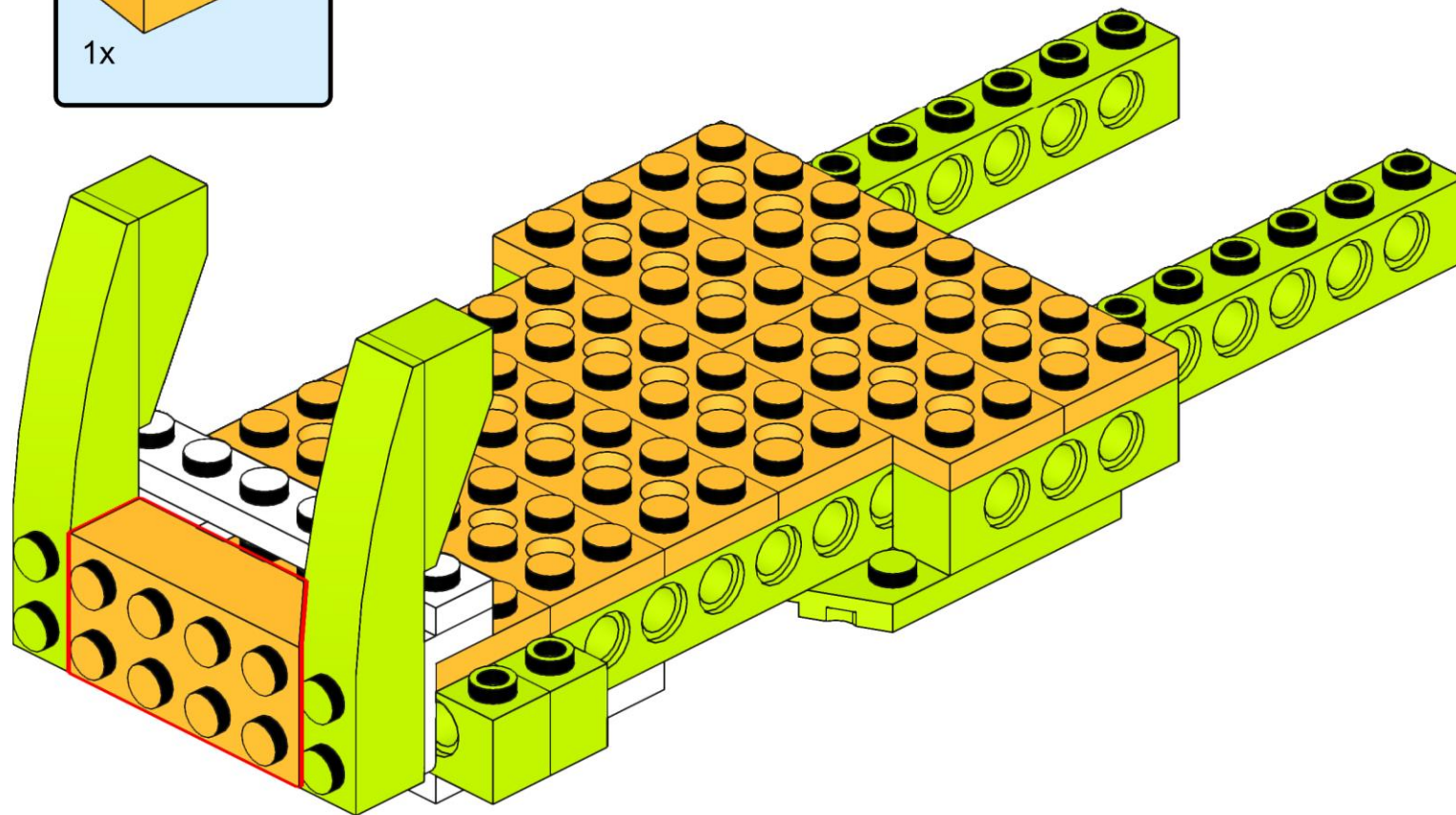
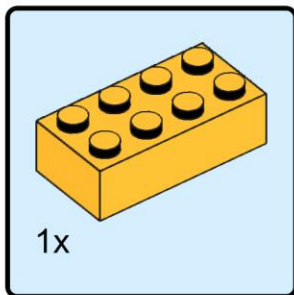

16

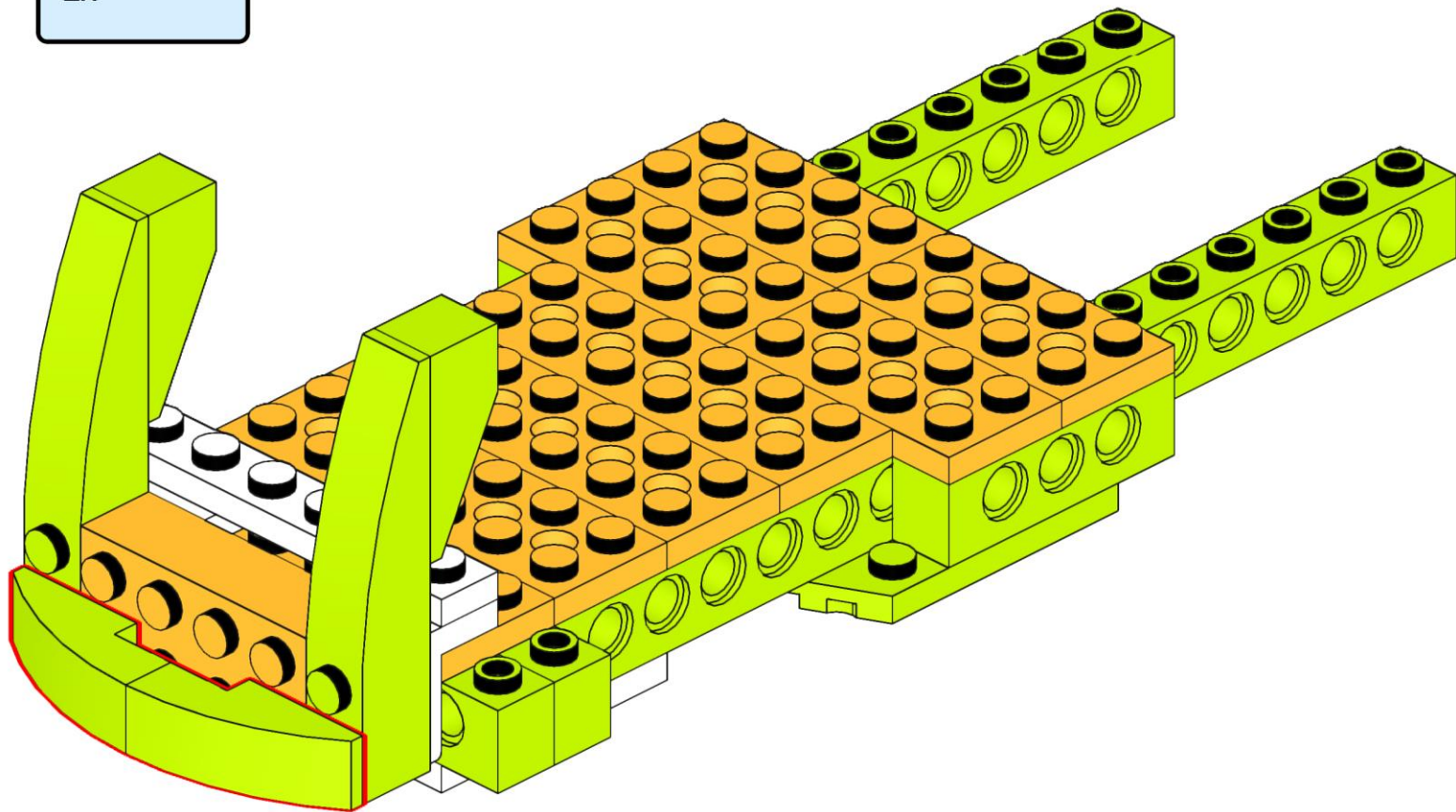
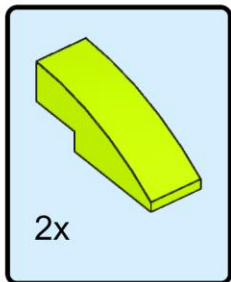

17

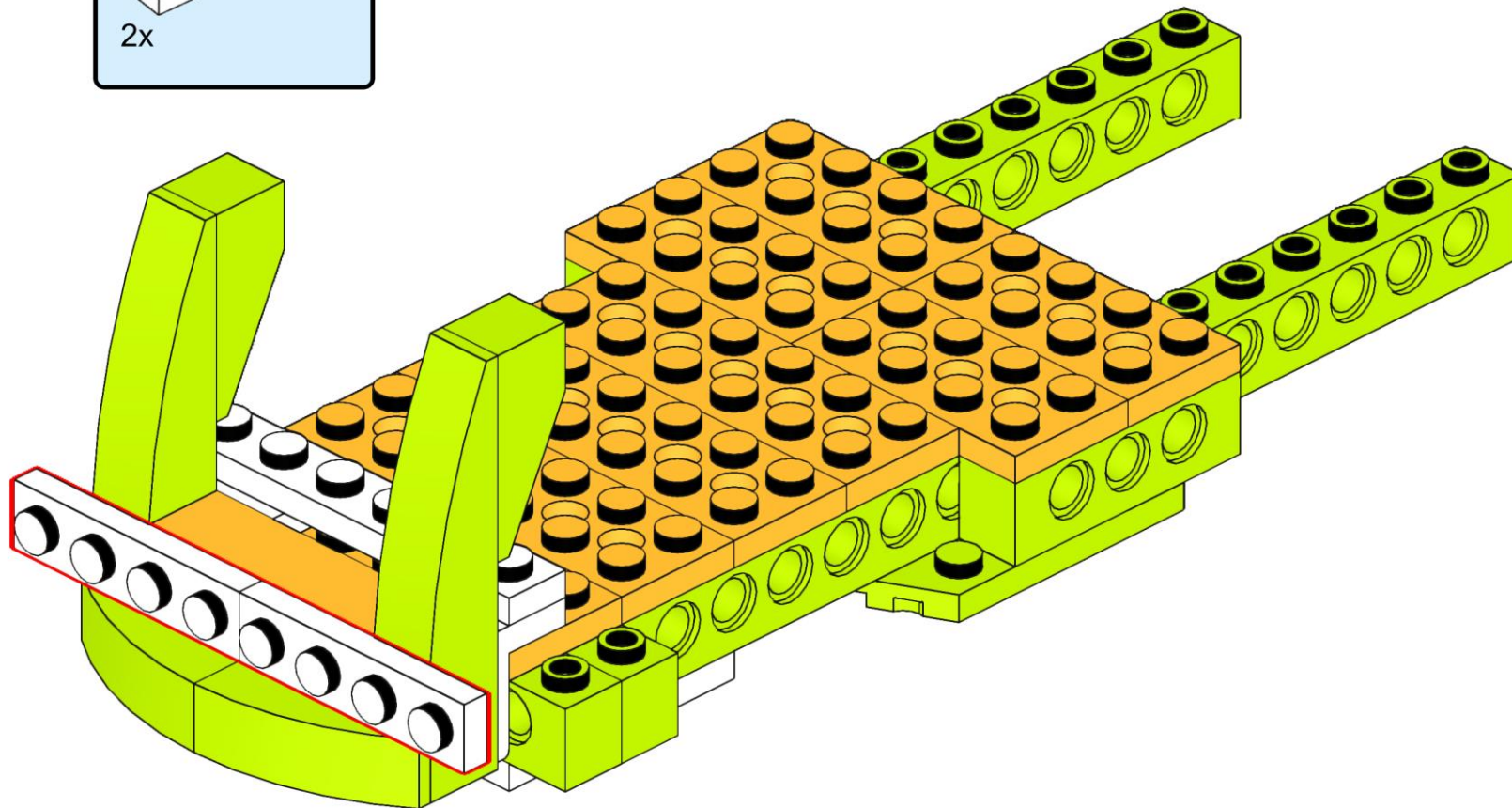
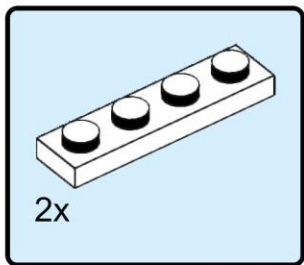

18

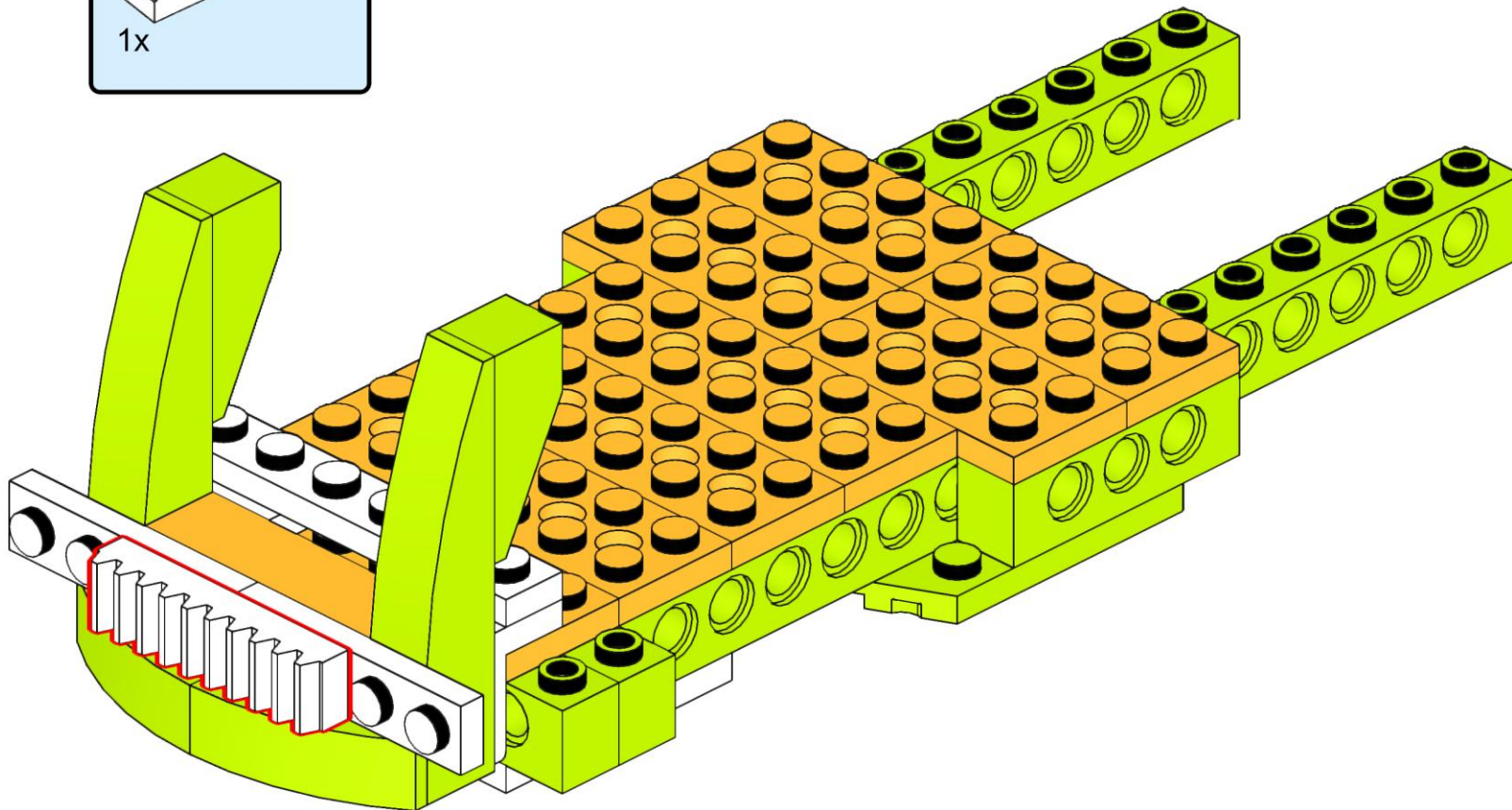
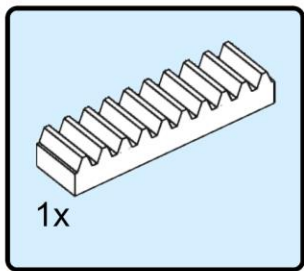

19

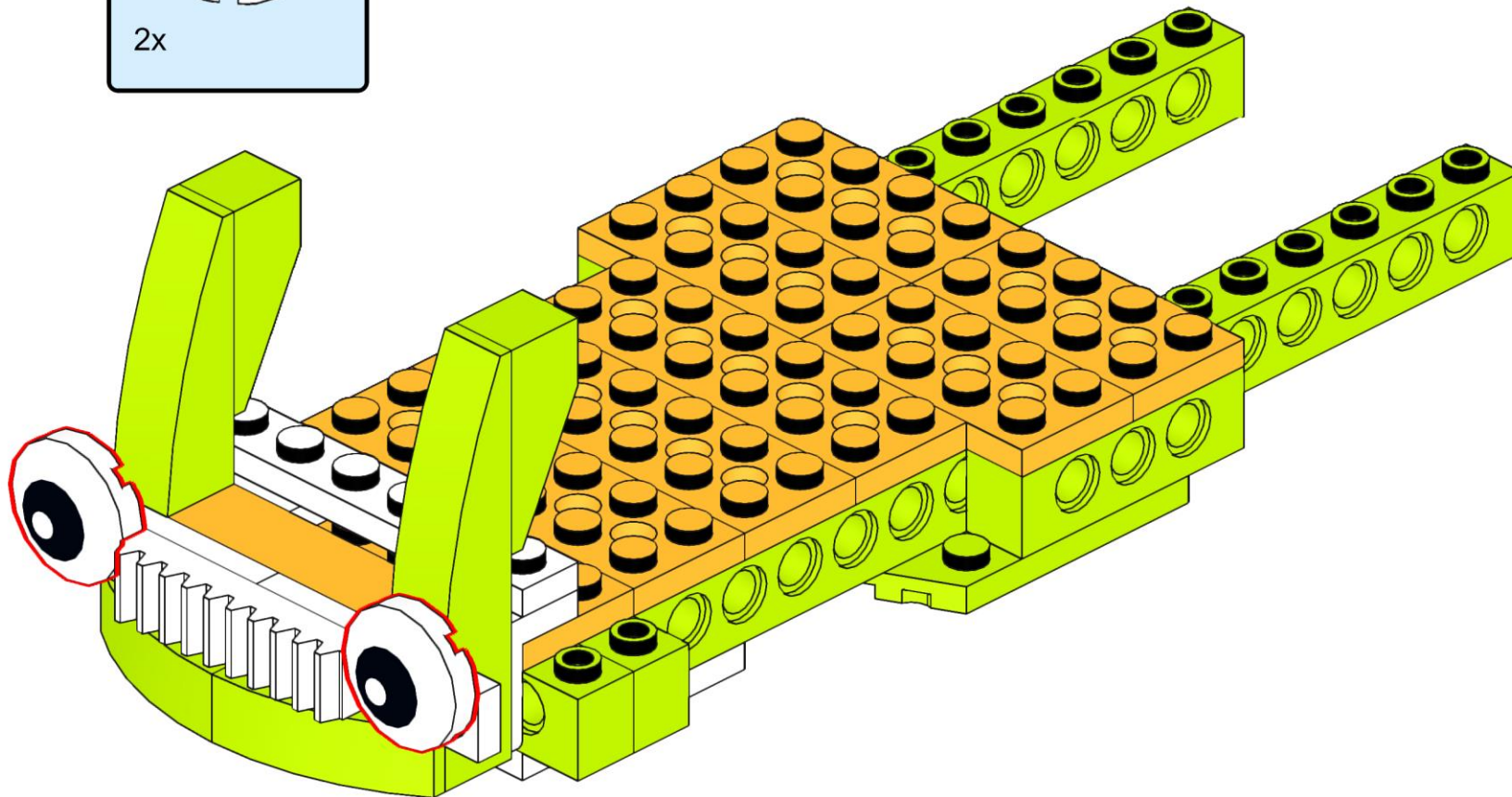
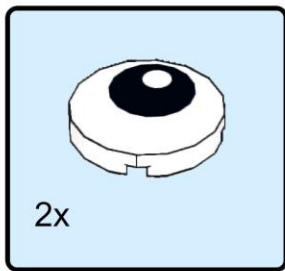

20

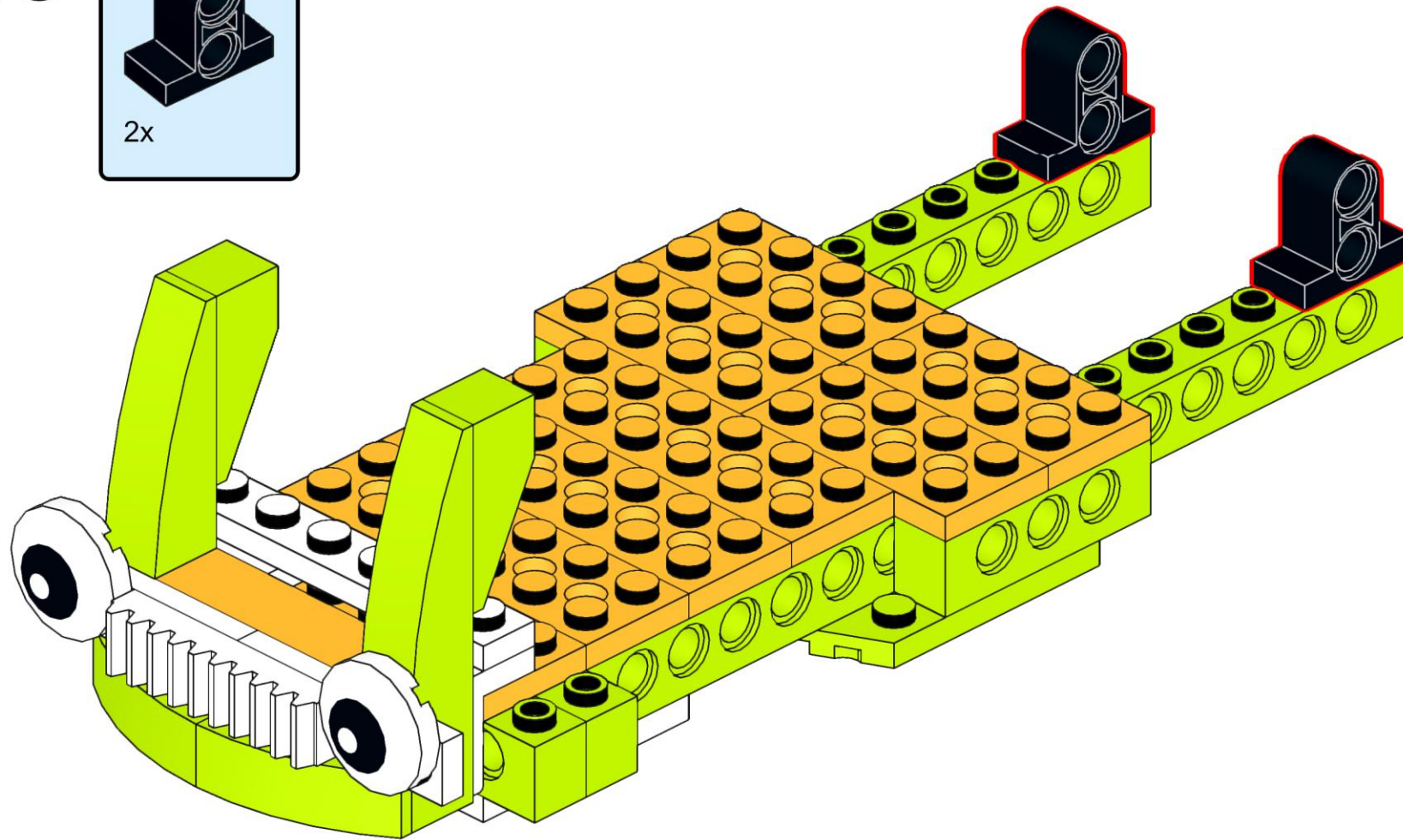
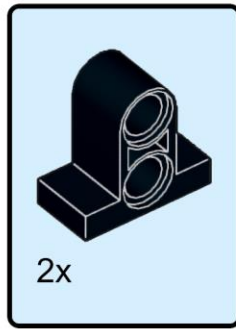

21

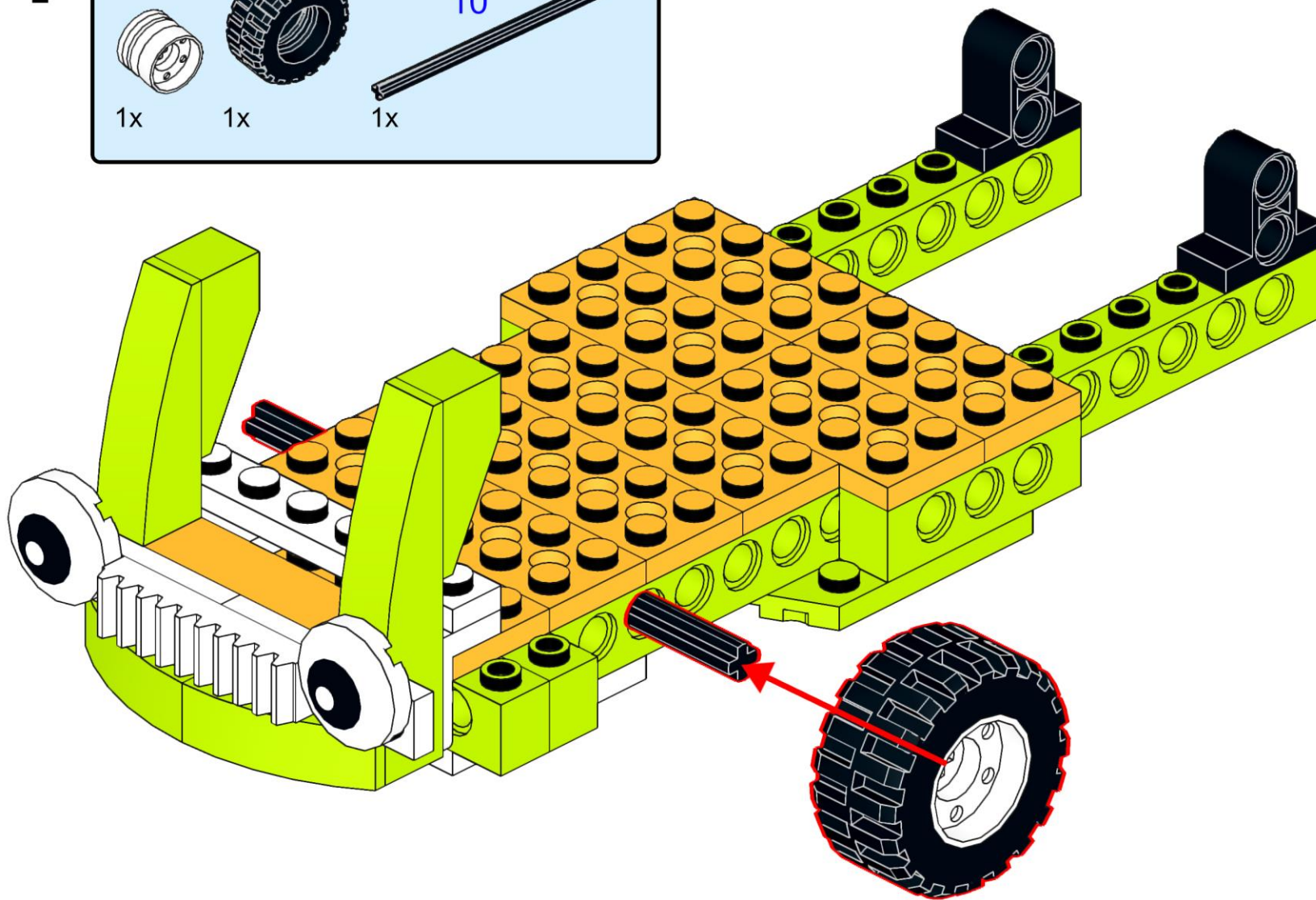
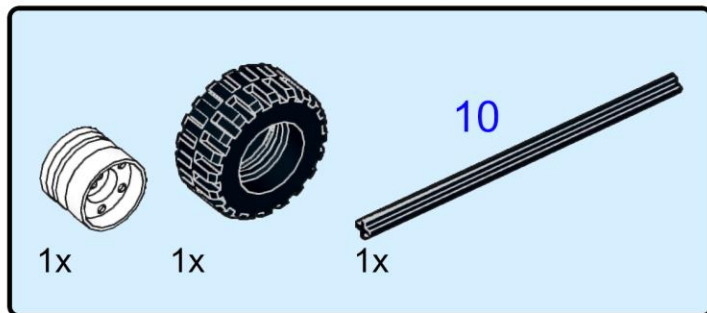

22

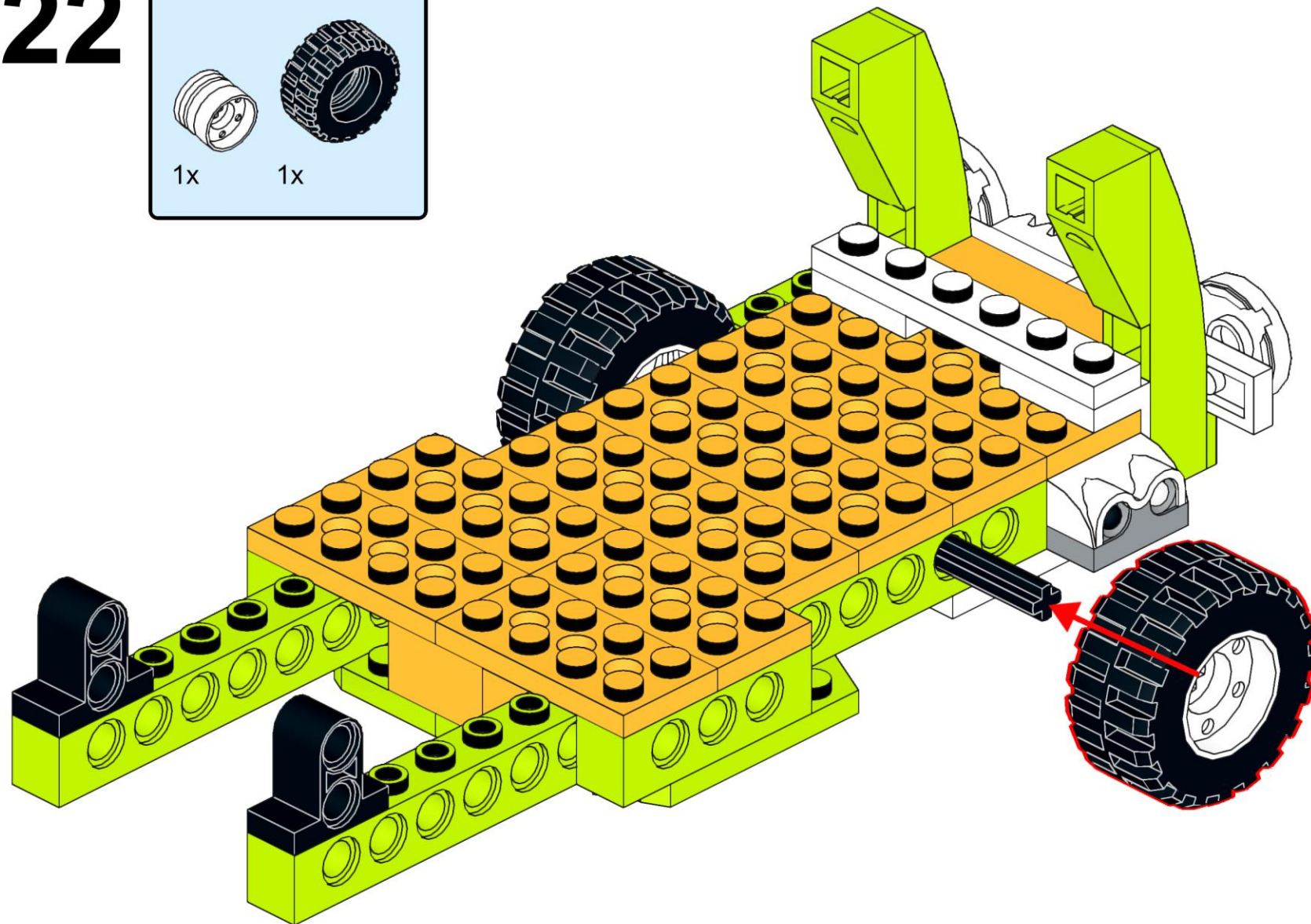
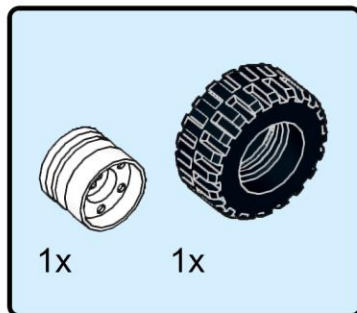

23

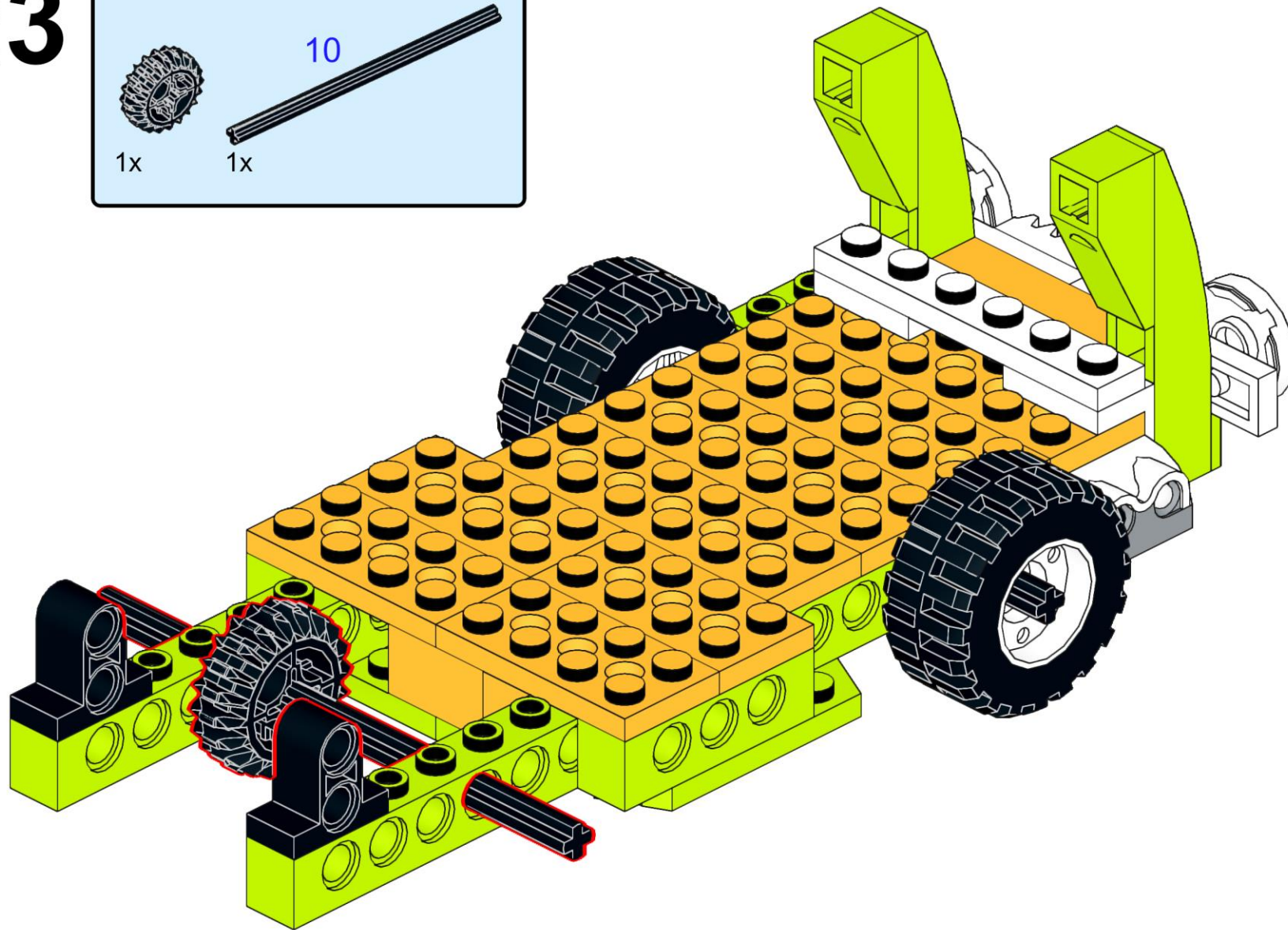
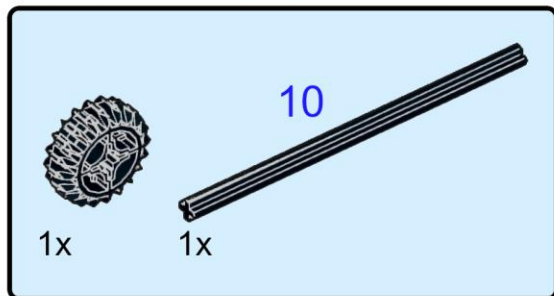

24

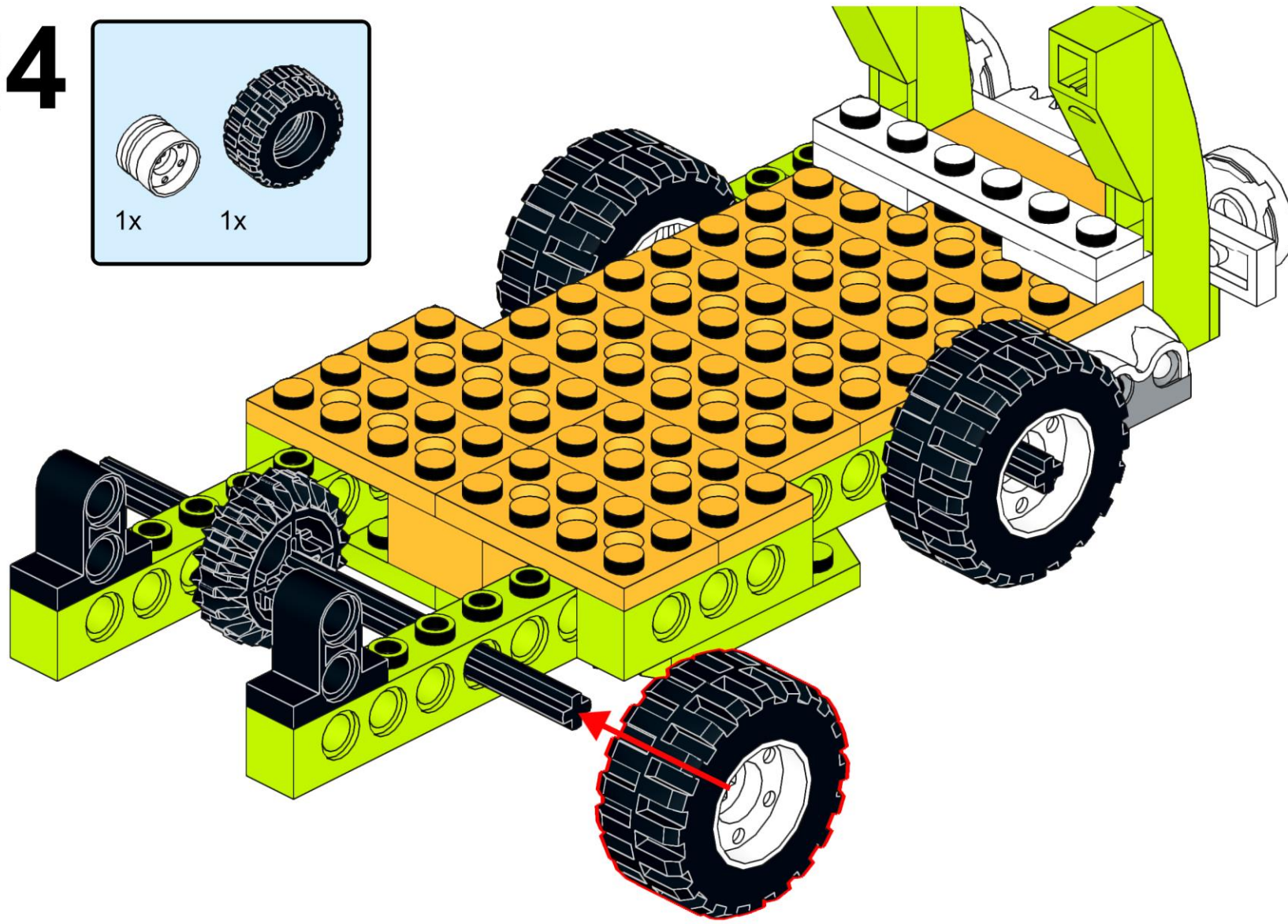
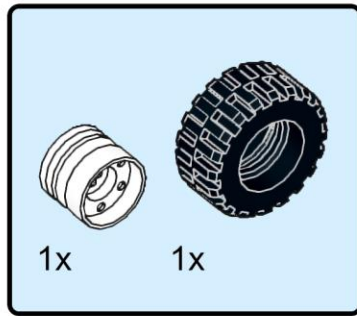

25

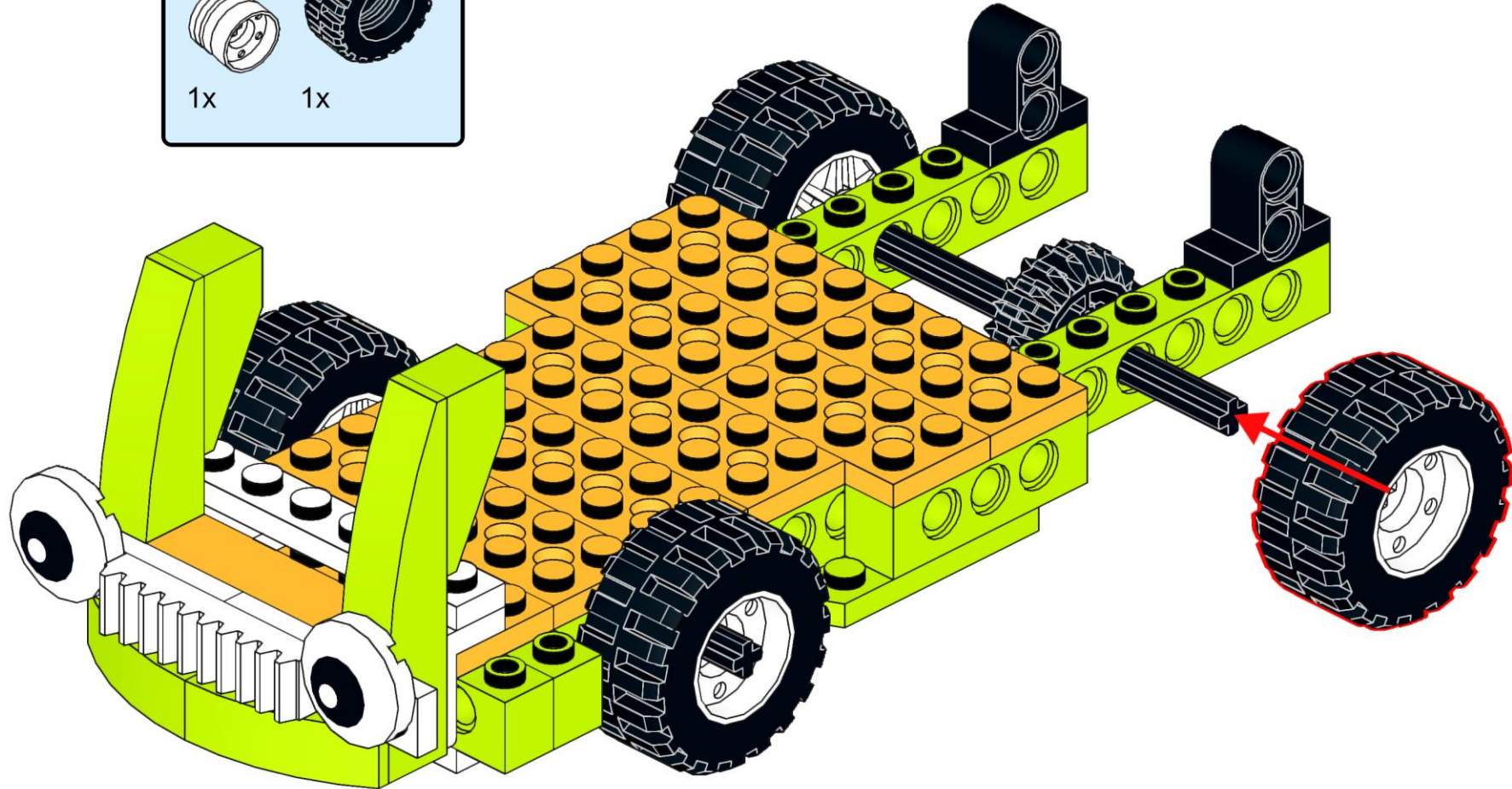
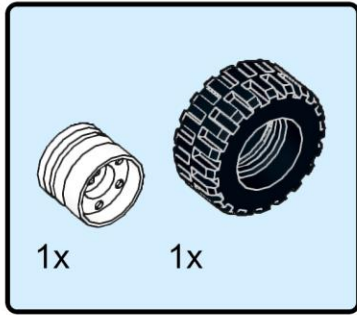

26

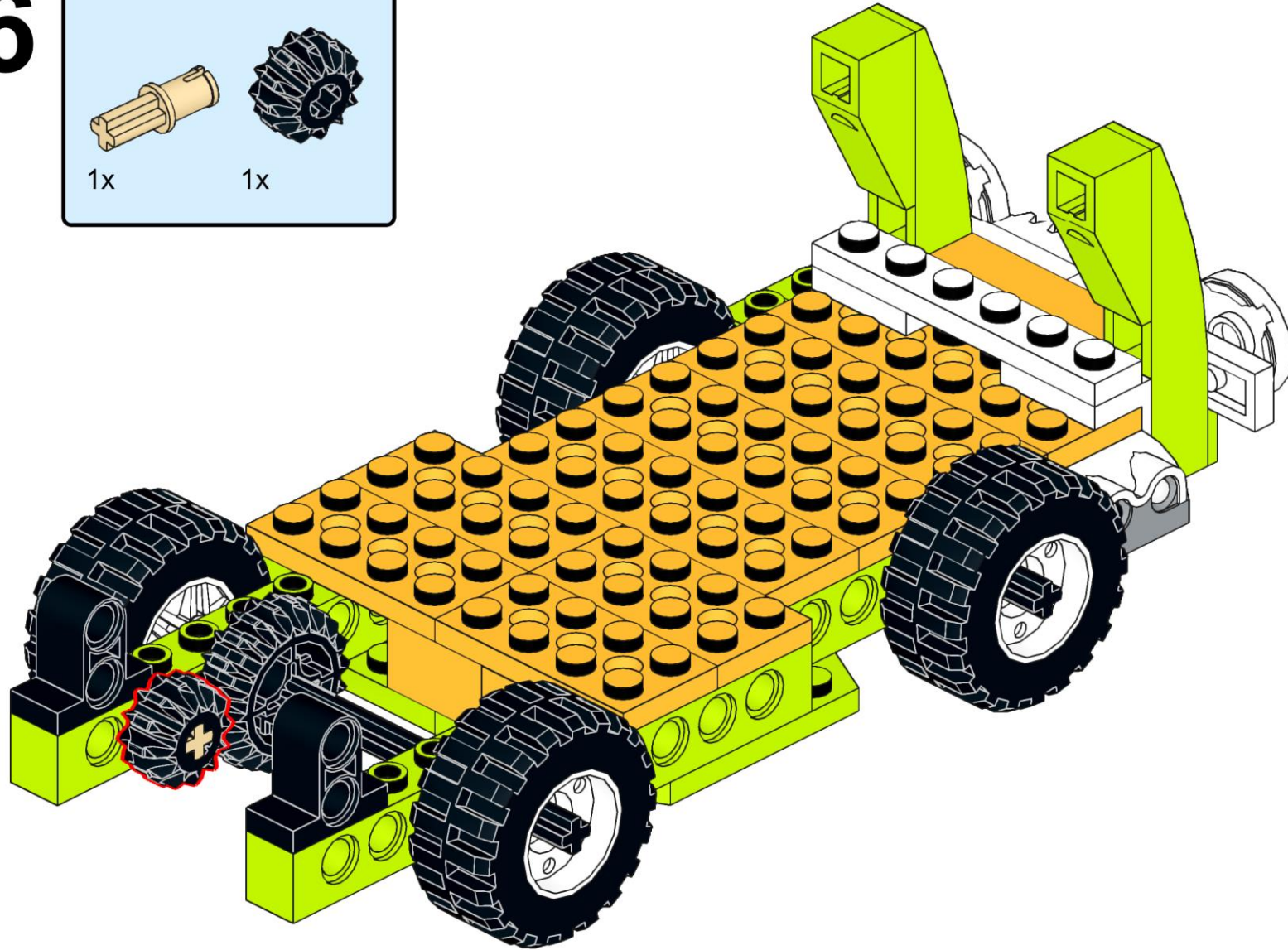
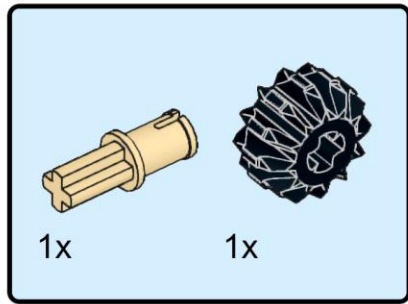

27

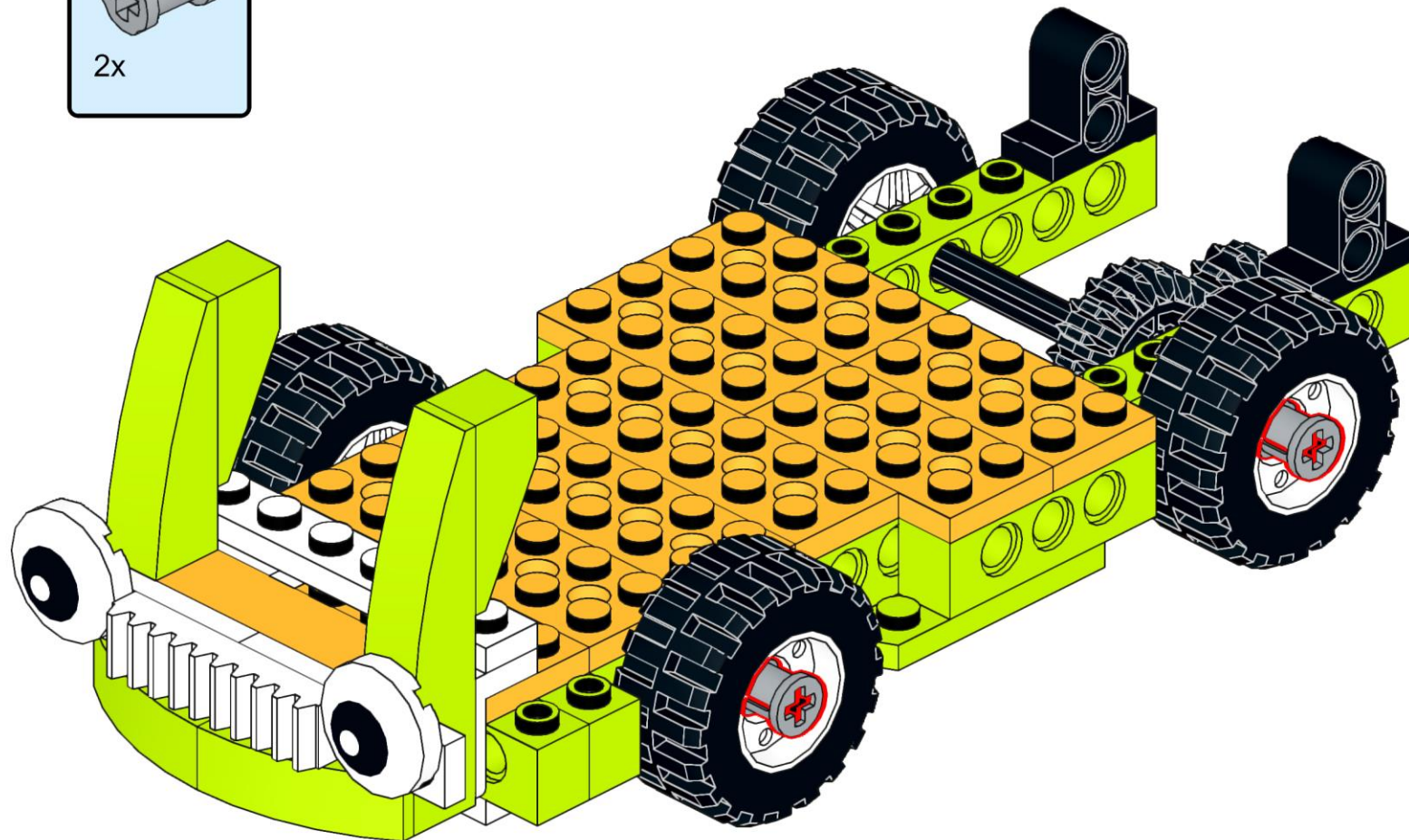
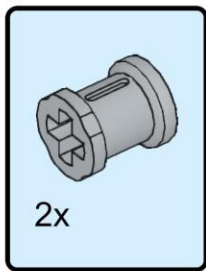

28

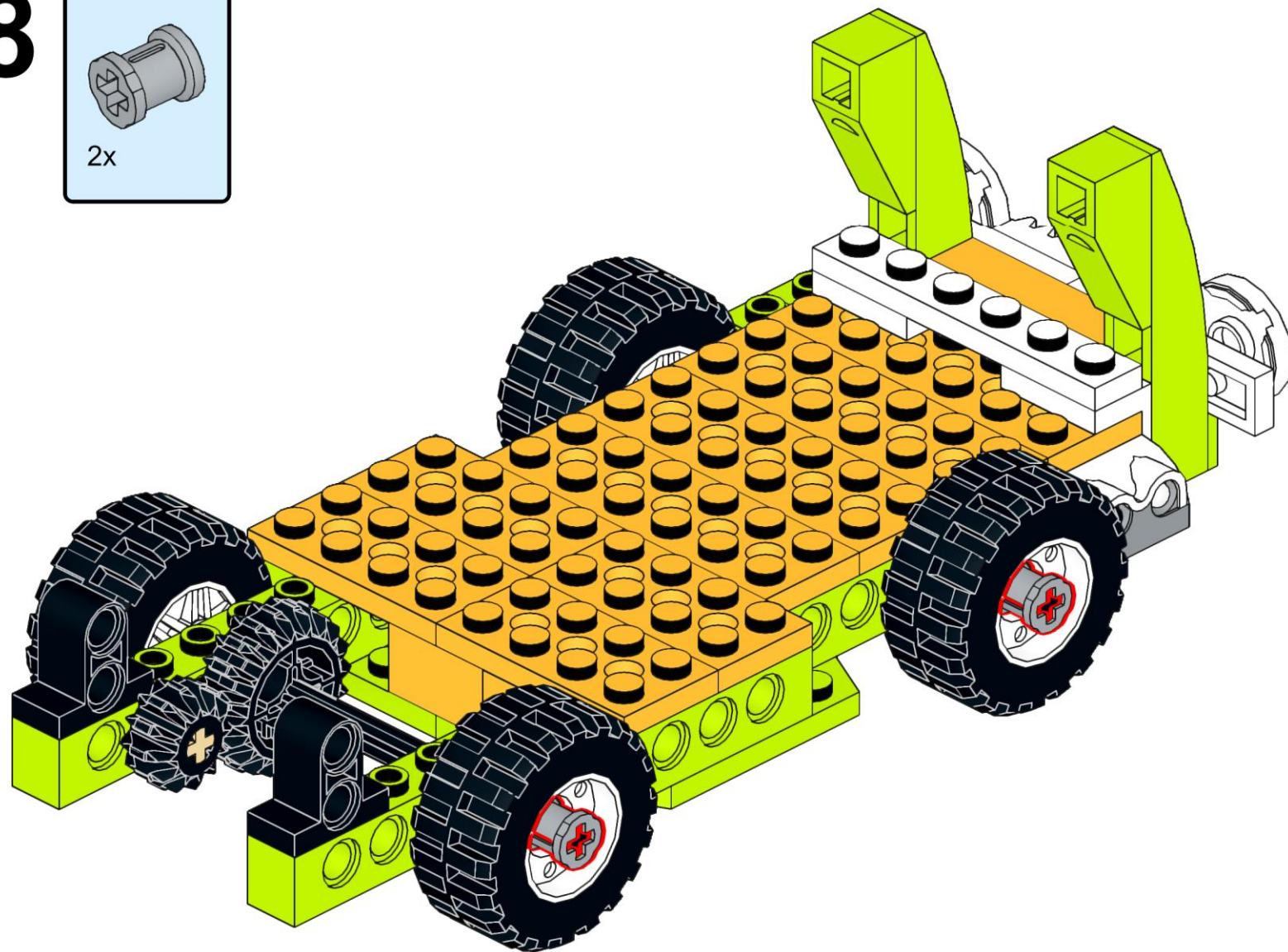
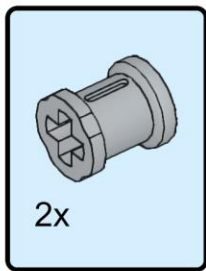

29

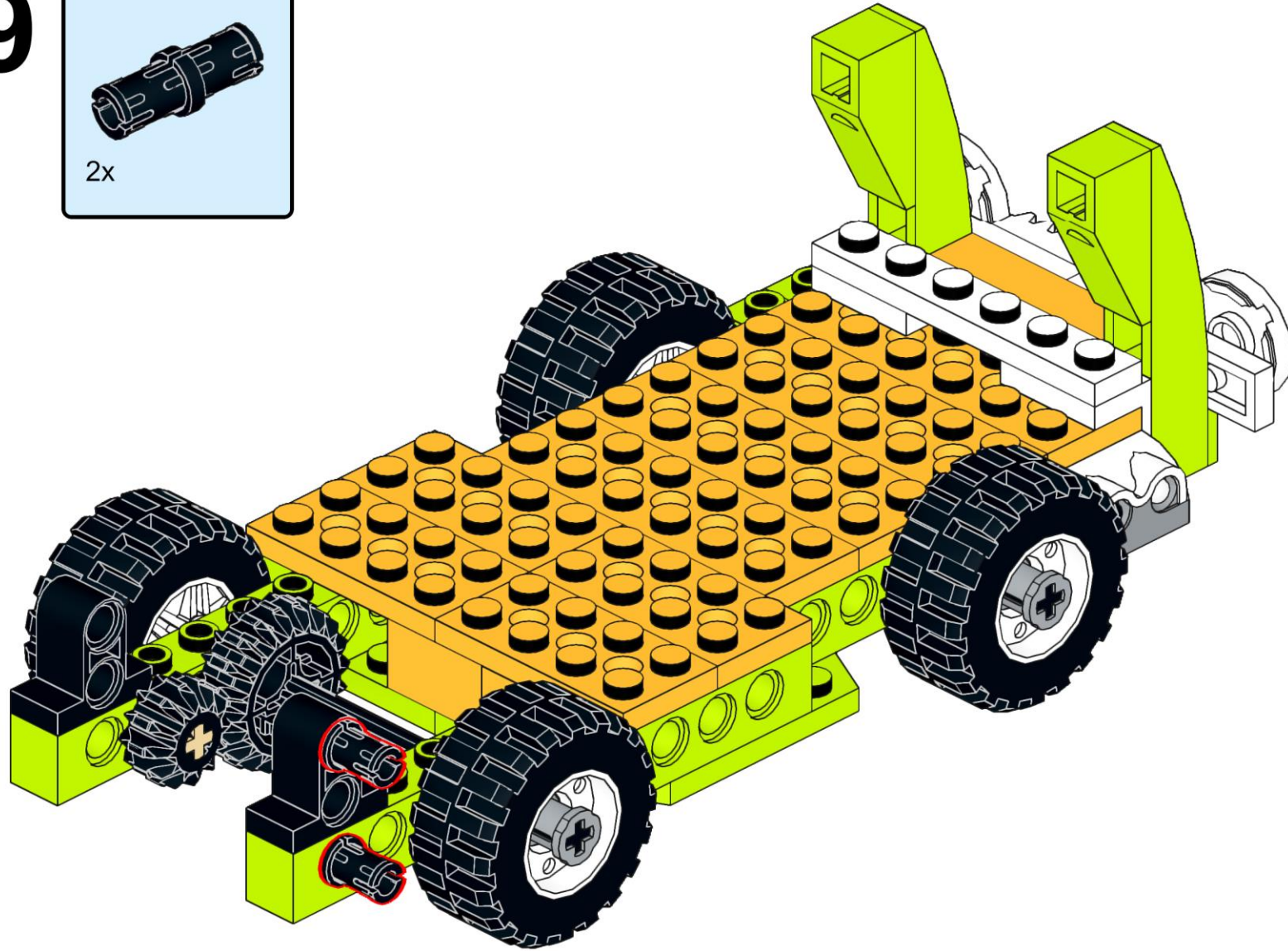

30

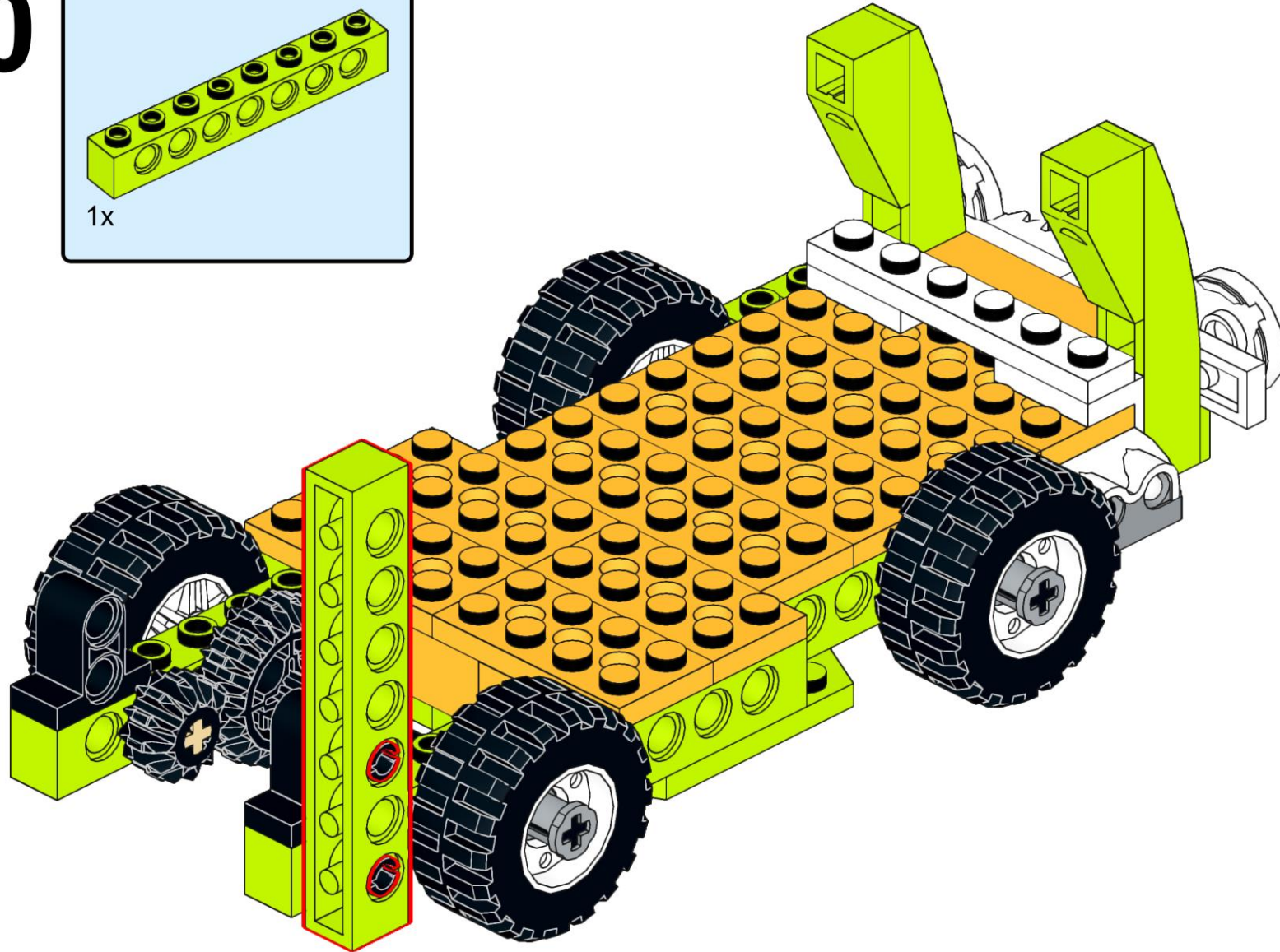
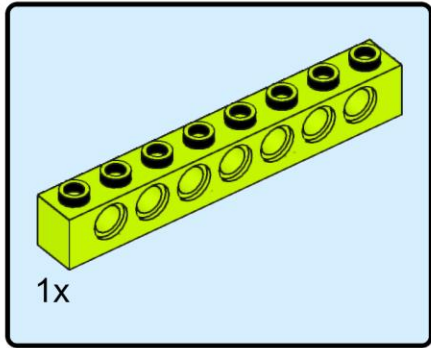

31

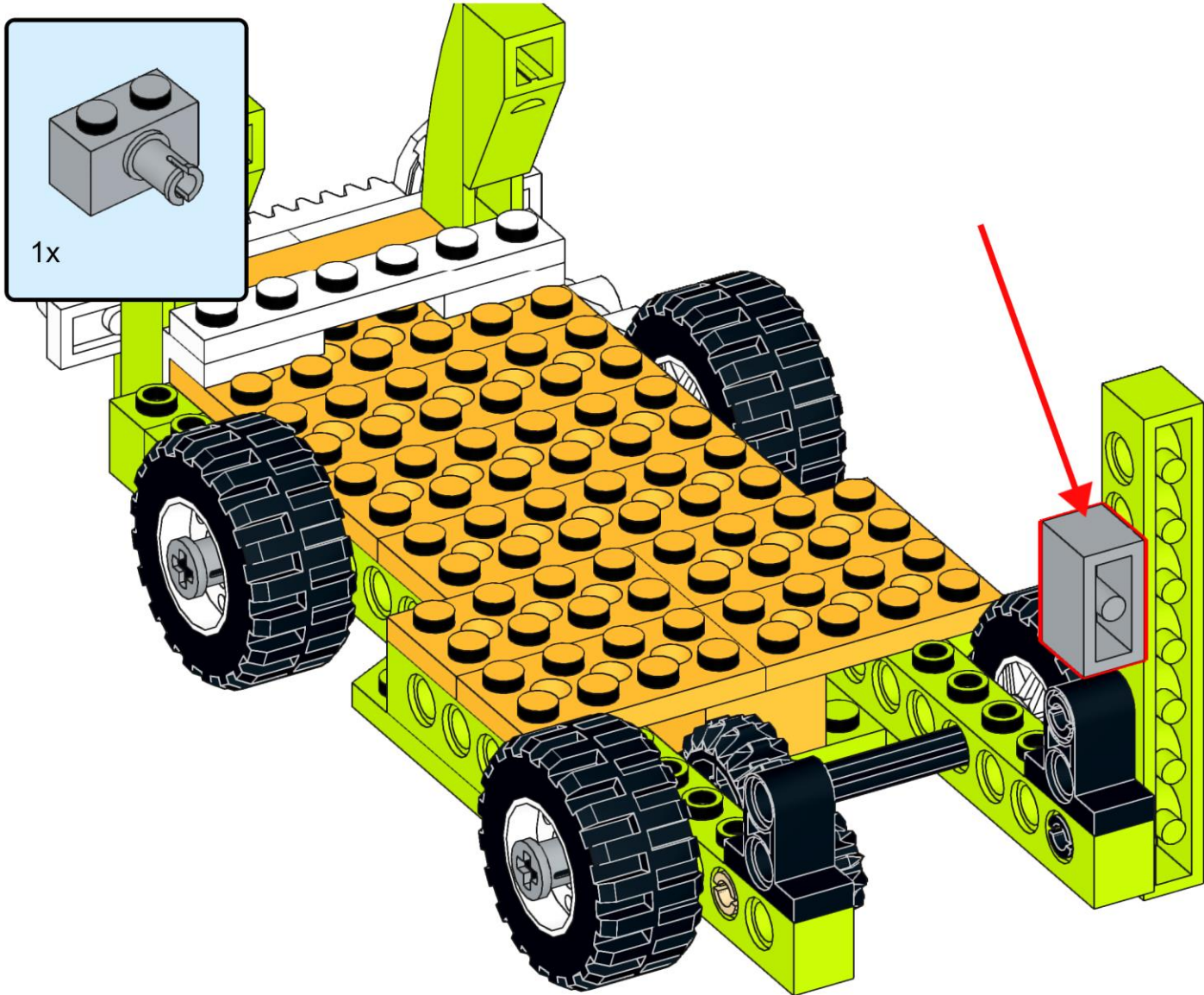
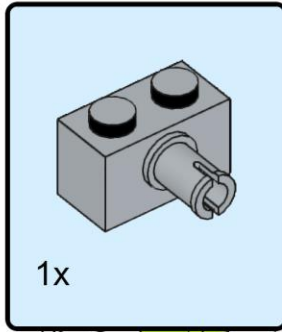

32

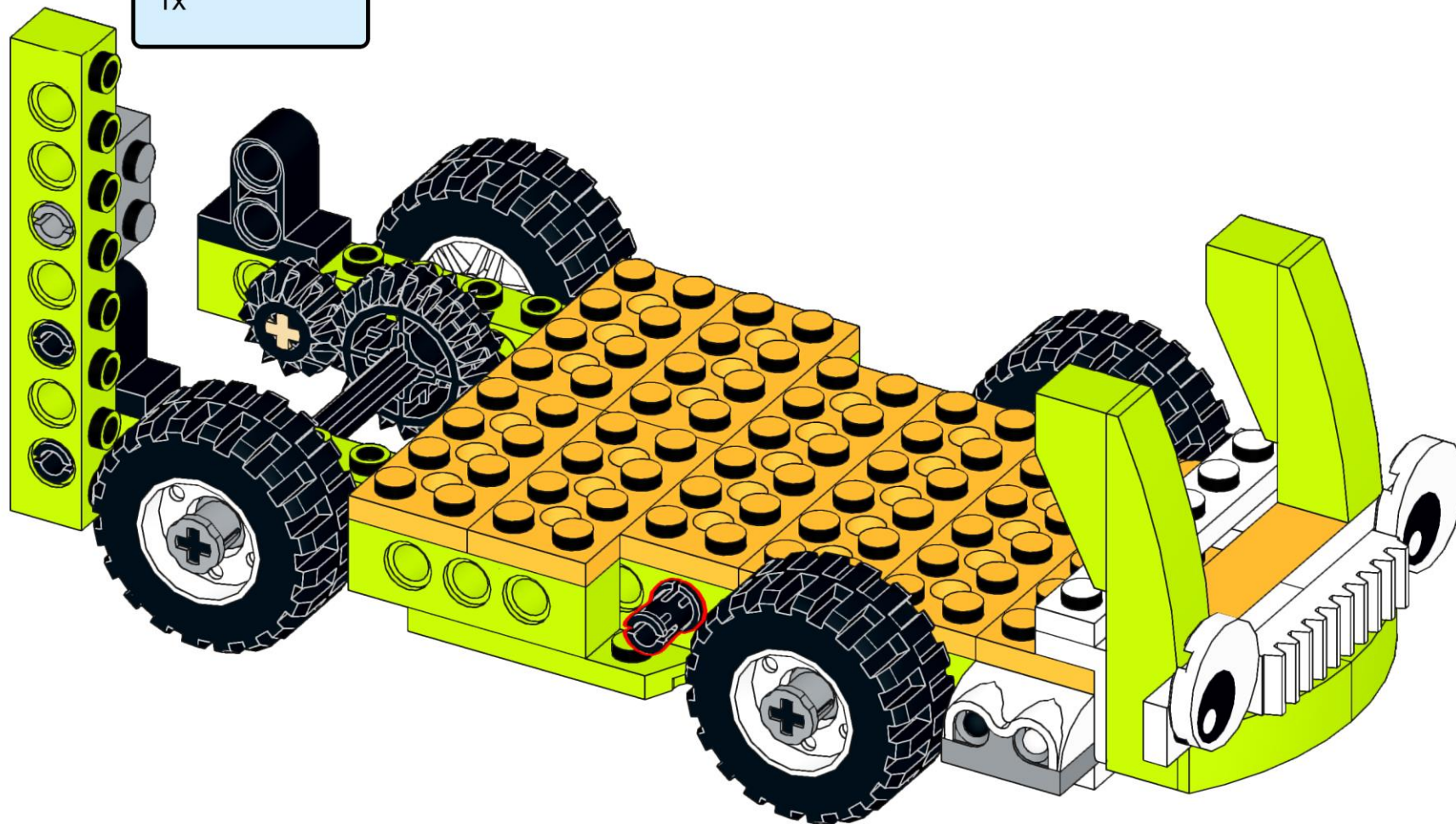
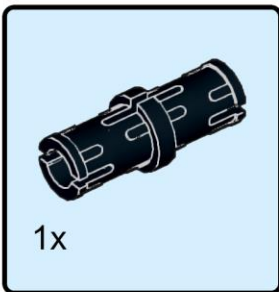

33

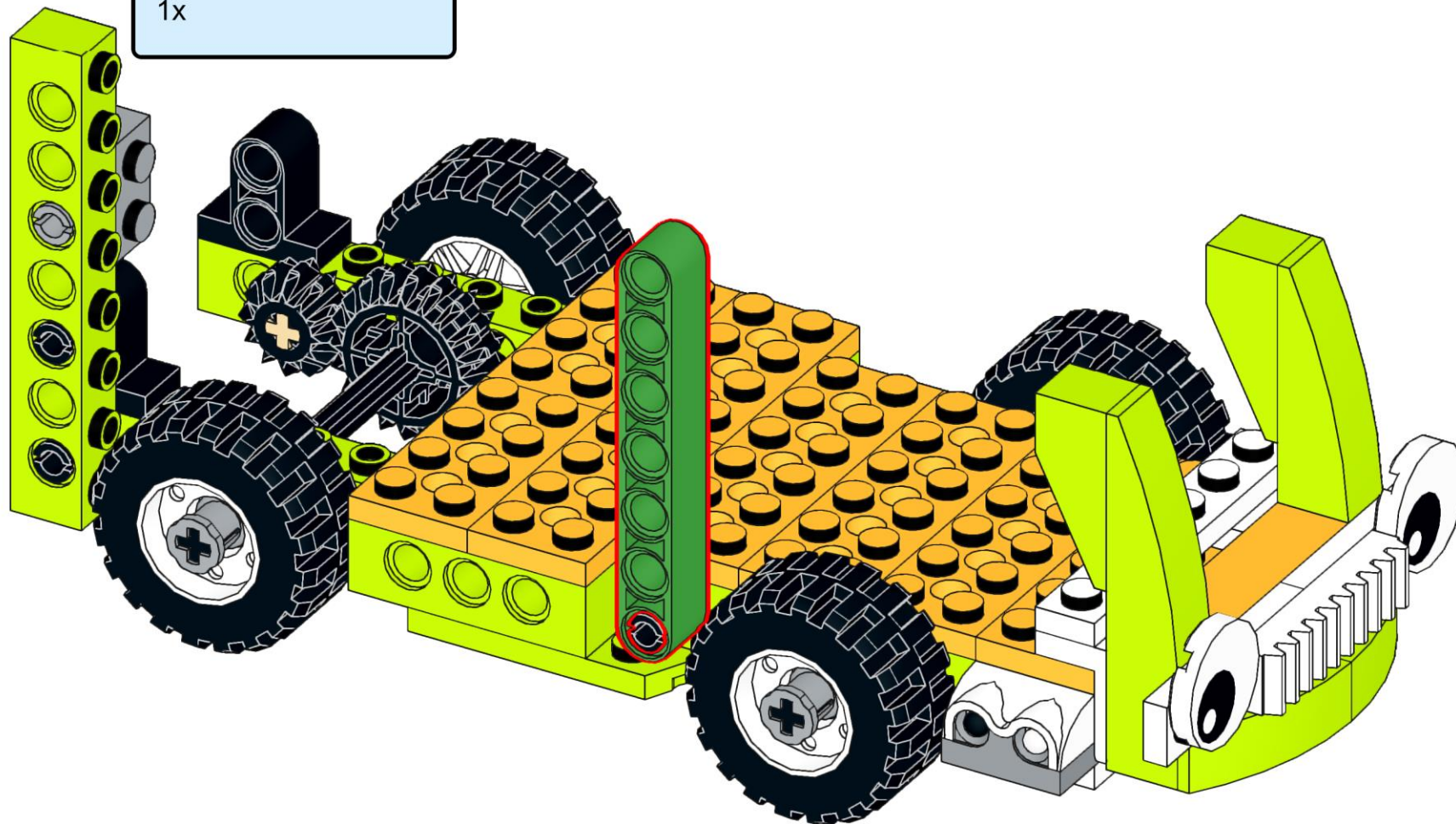
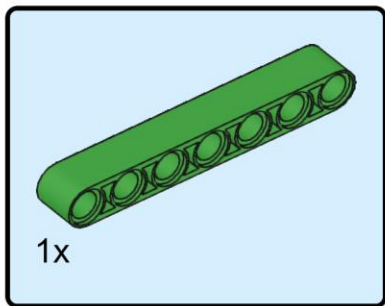

34

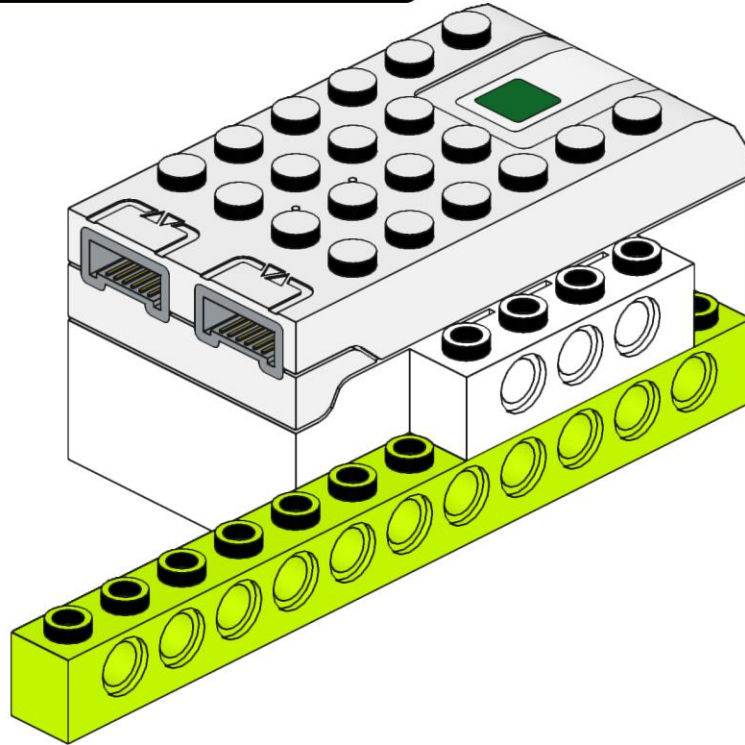
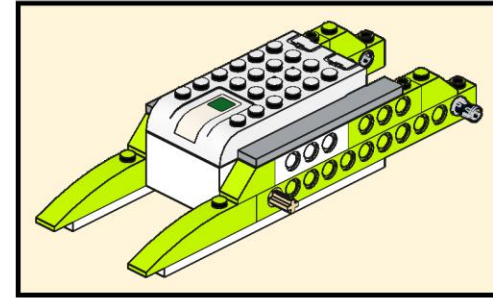
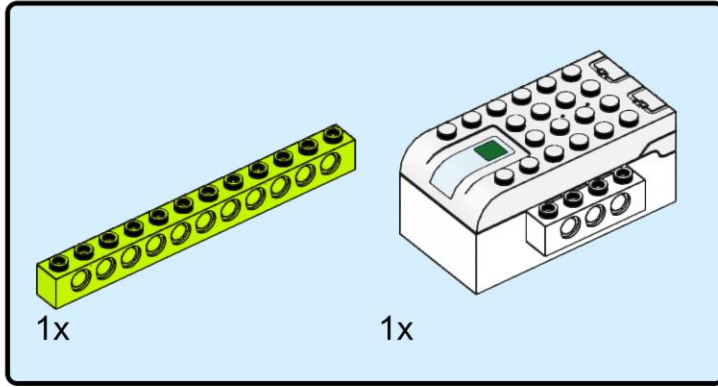

35

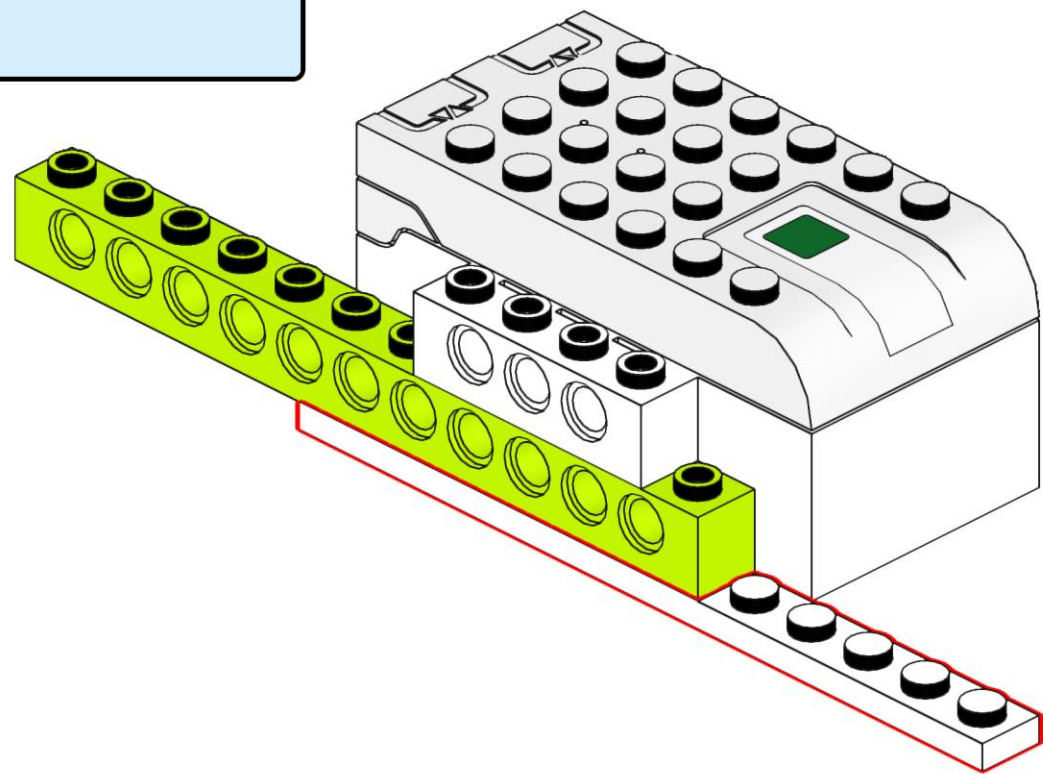
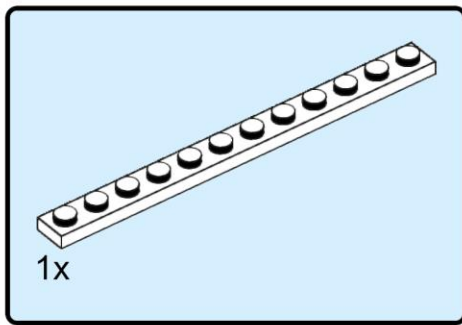

36

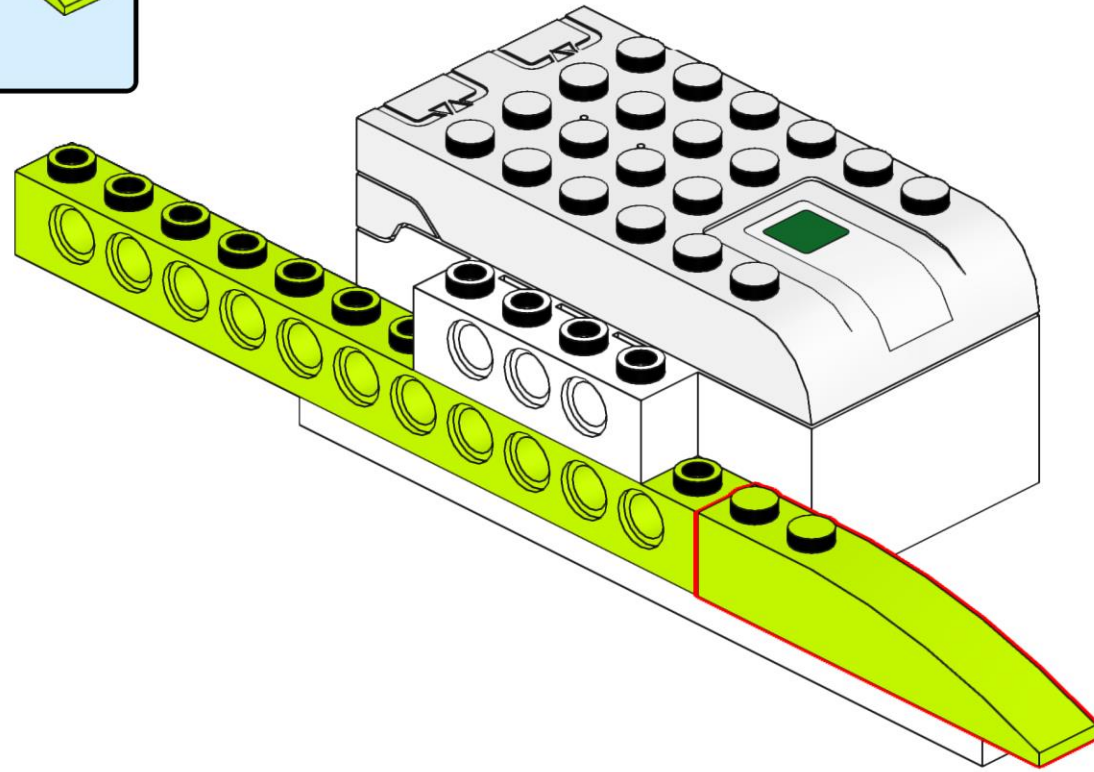
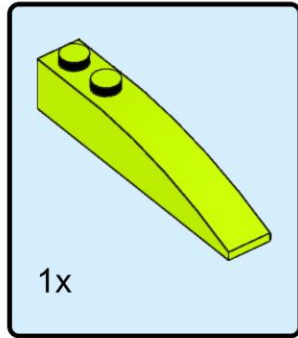

37

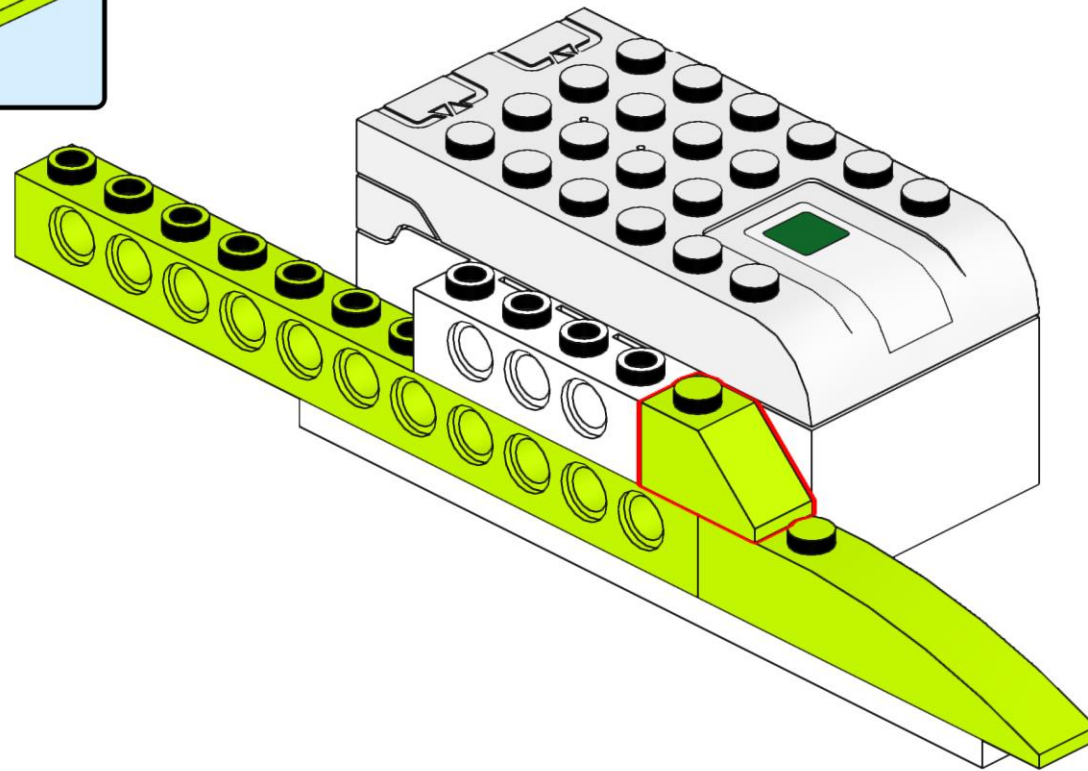
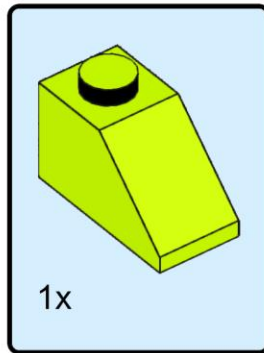

38

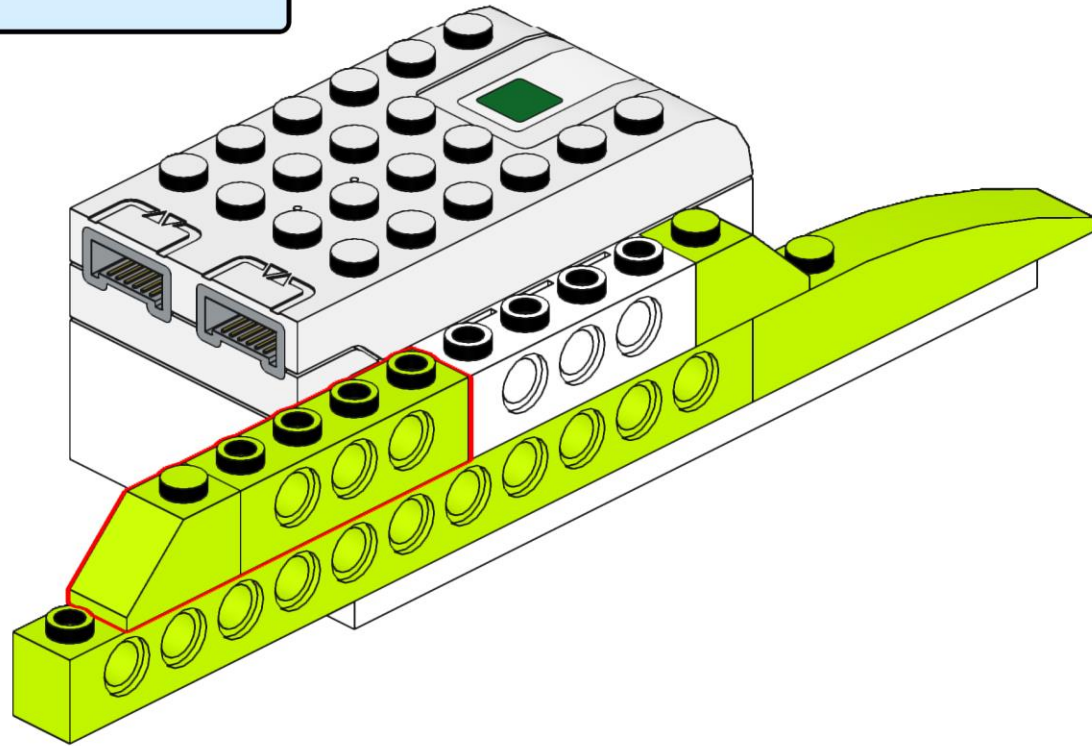
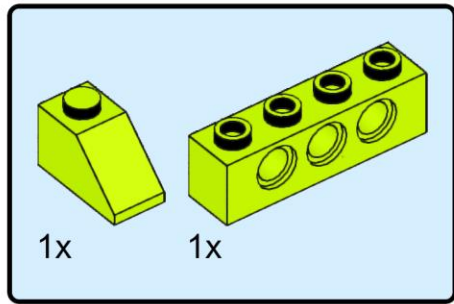

39

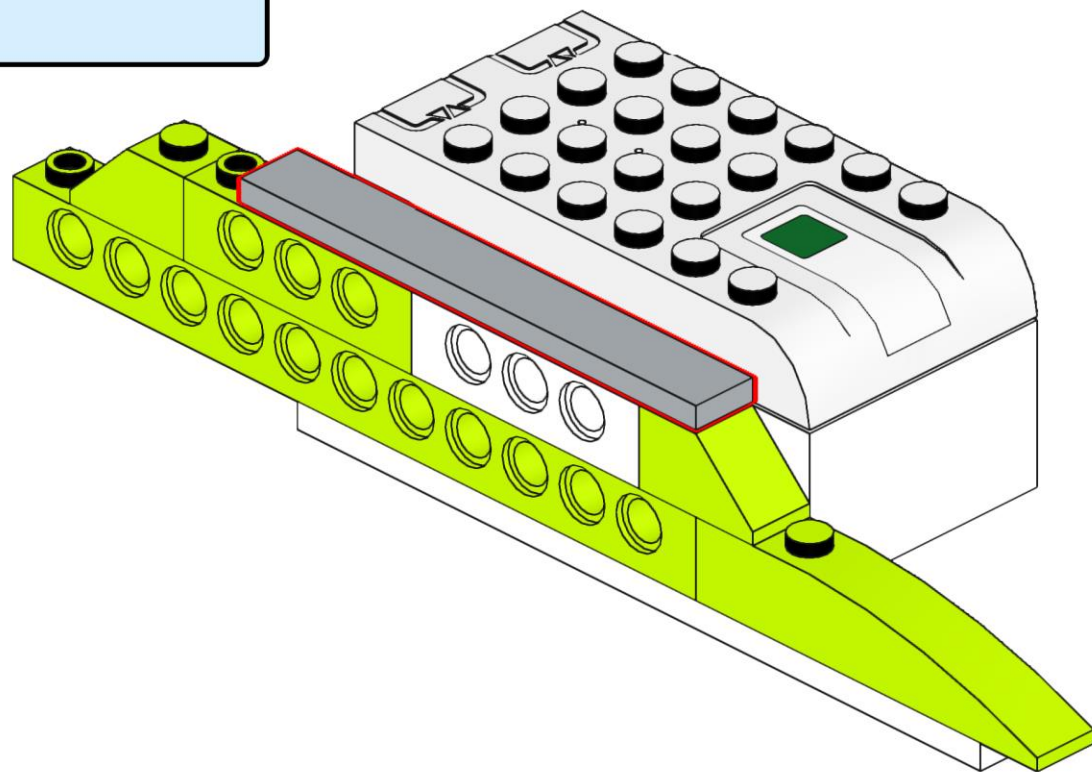
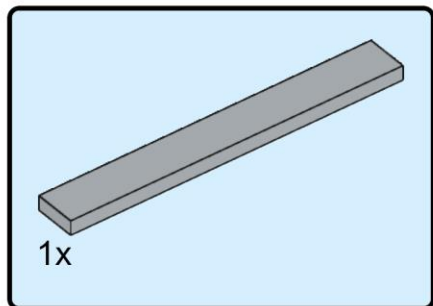

40

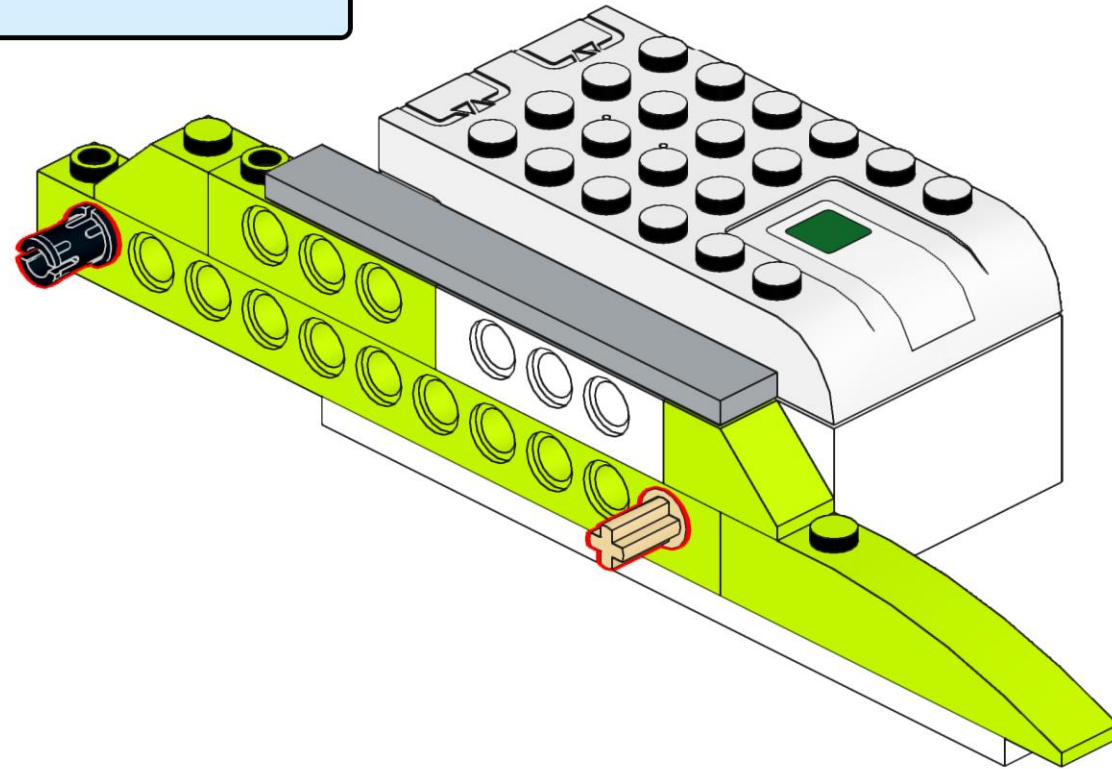
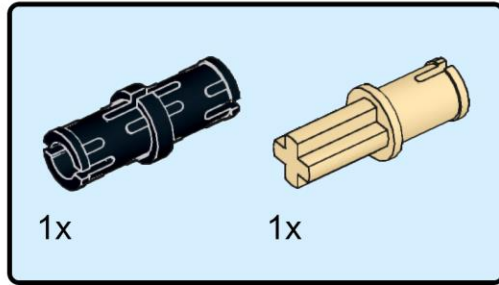

41

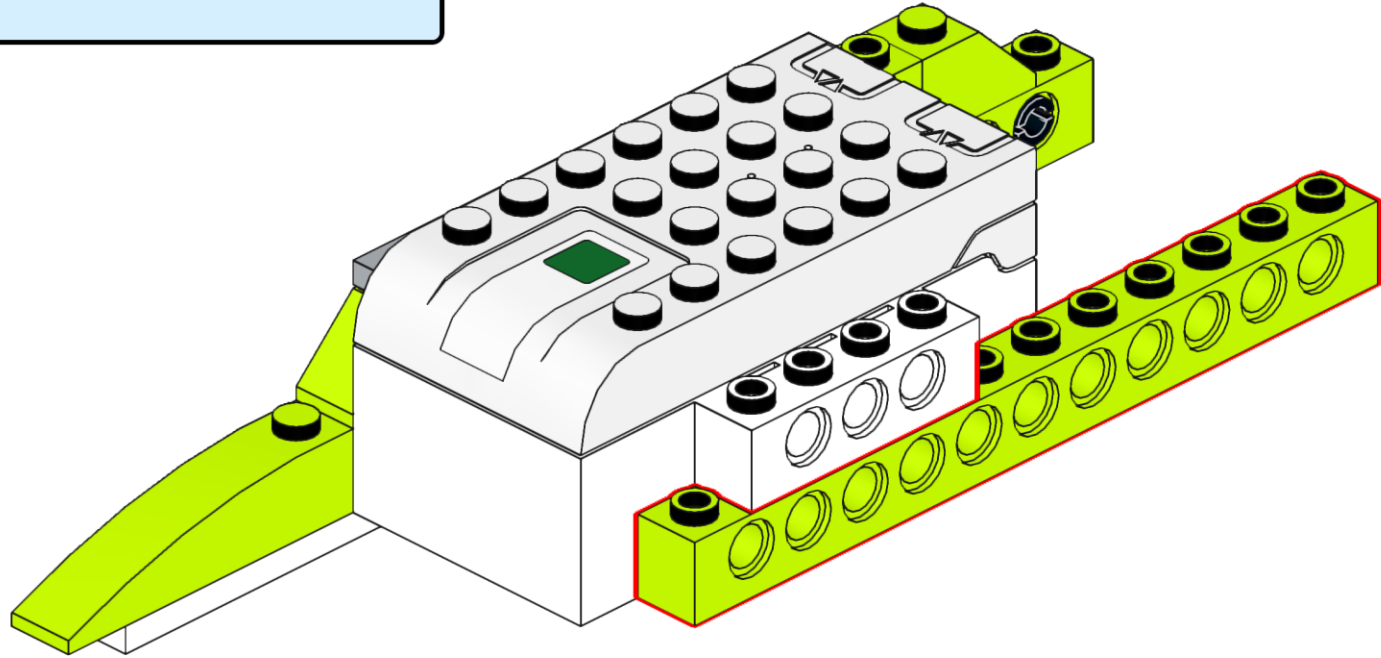
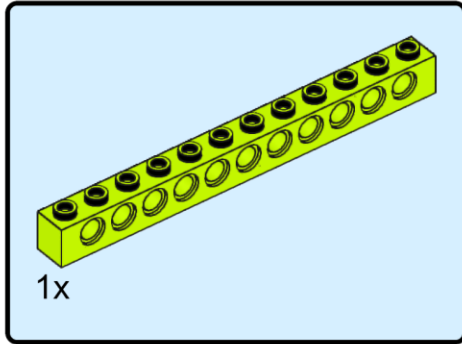

42

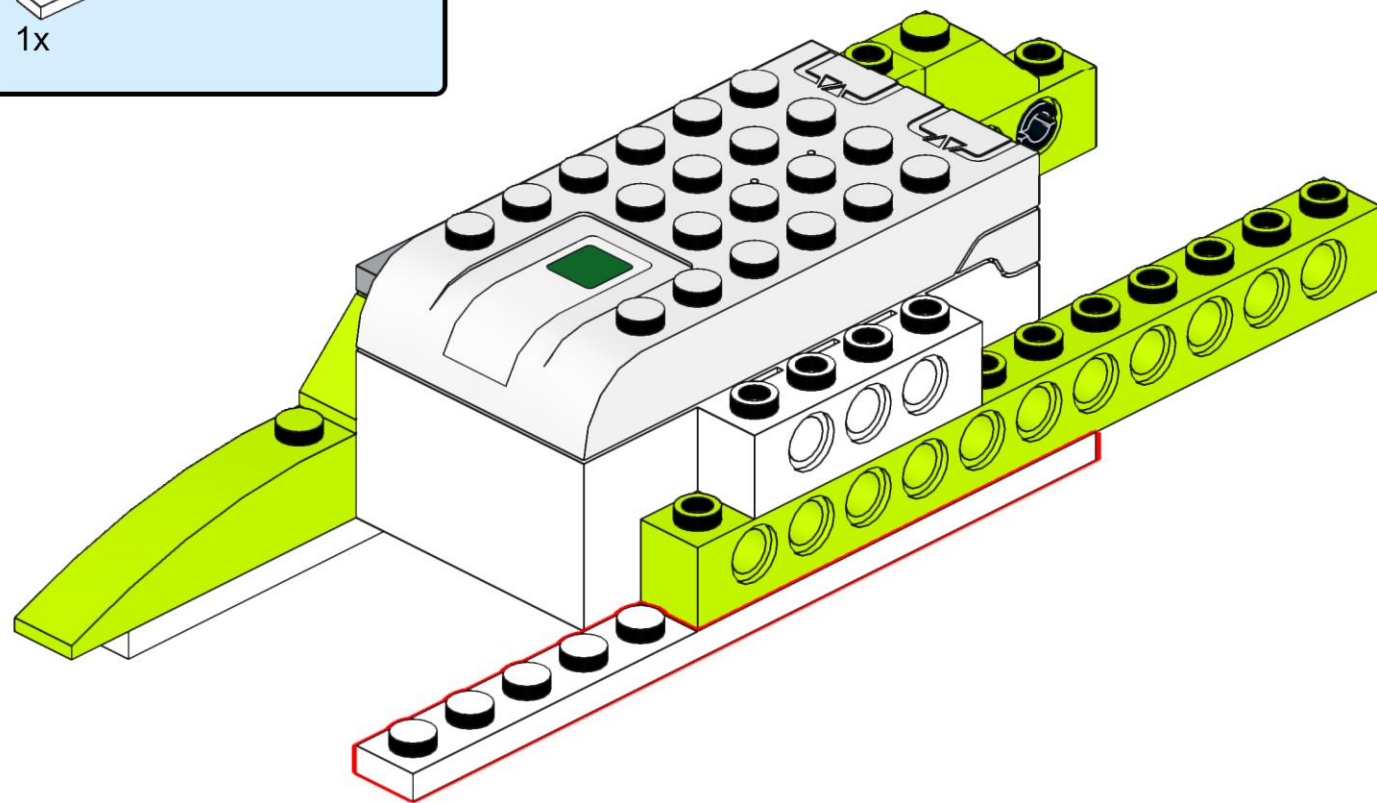
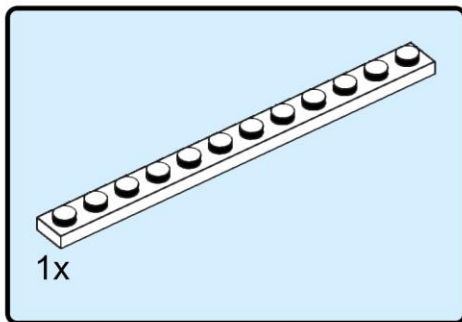

43

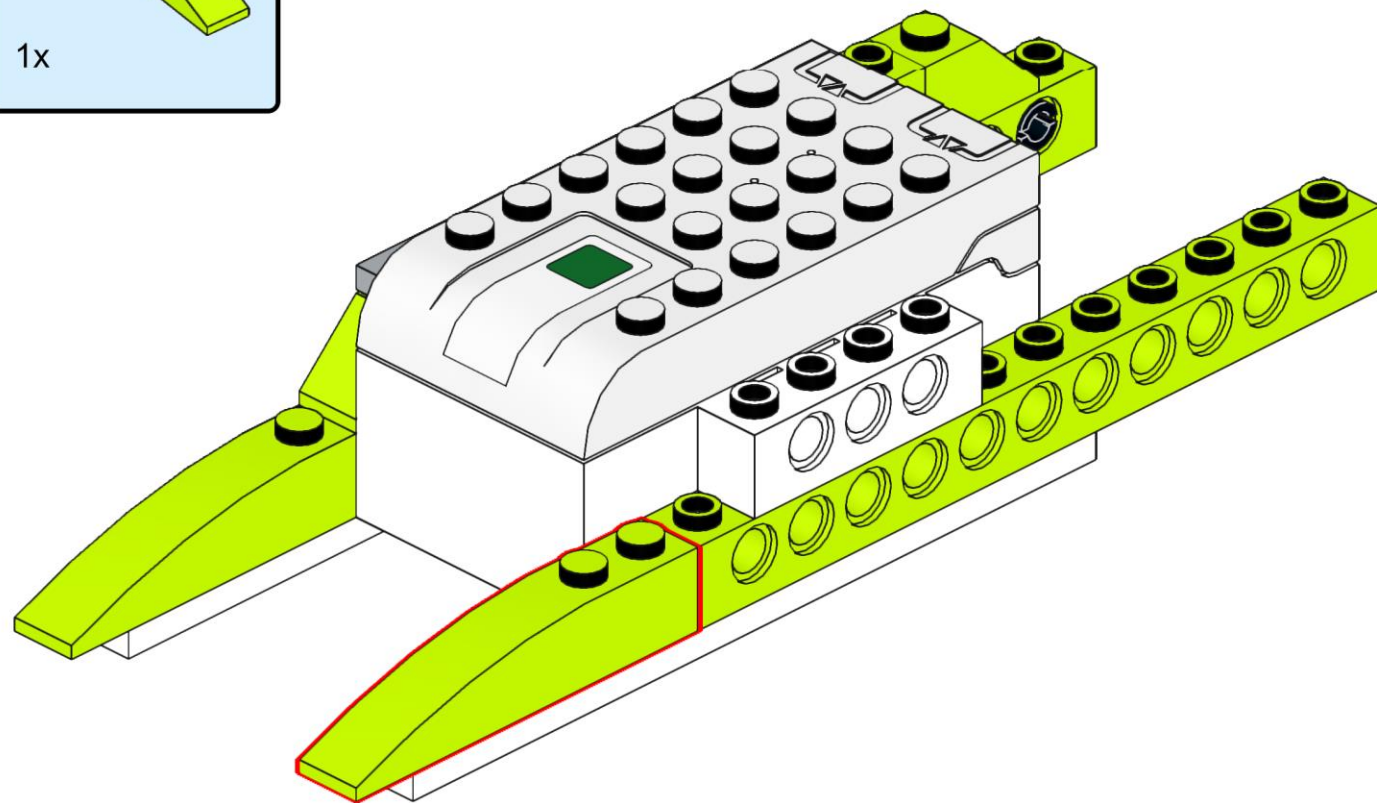
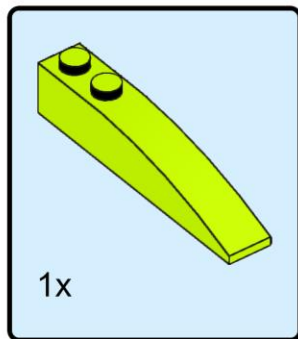

44

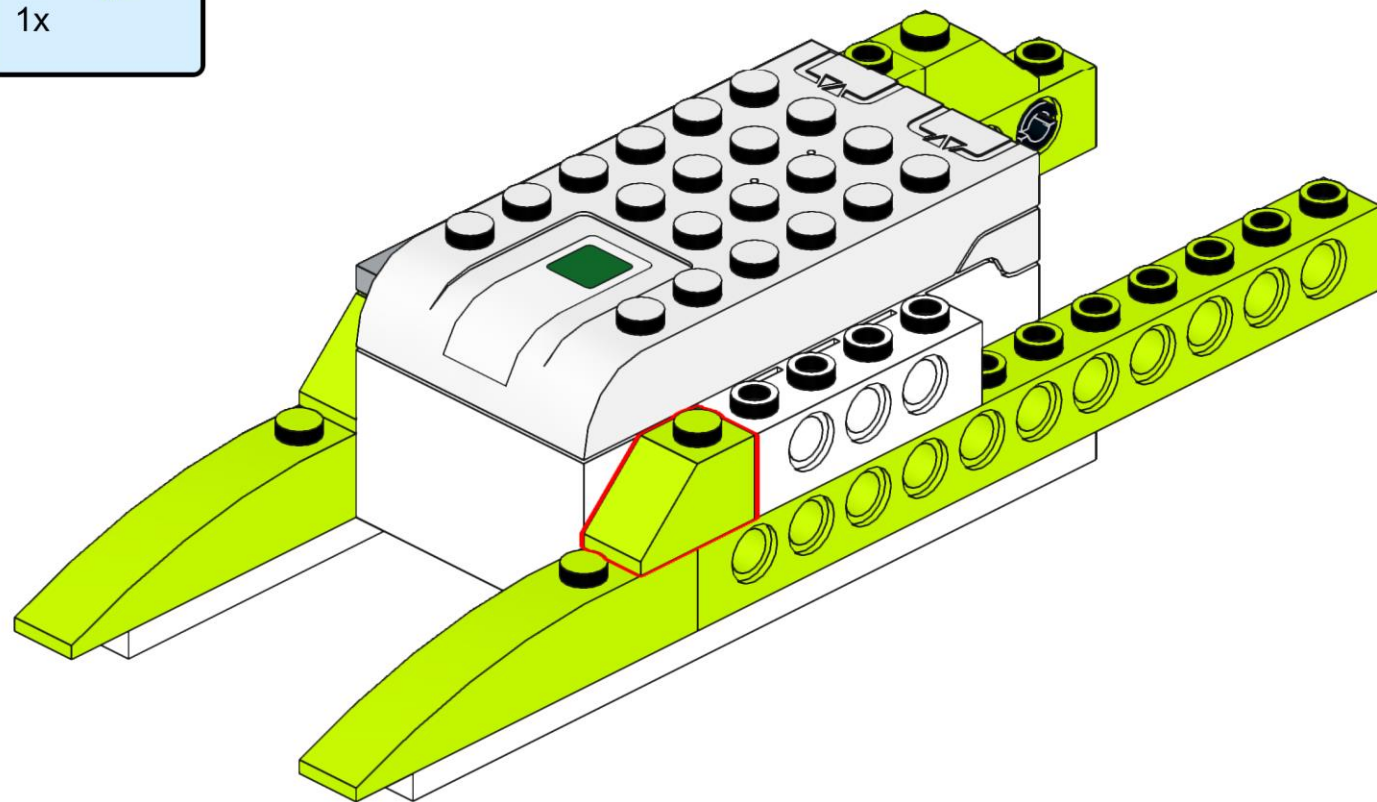
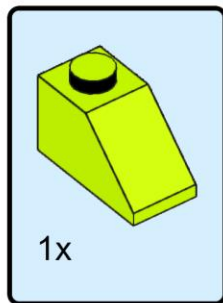

45

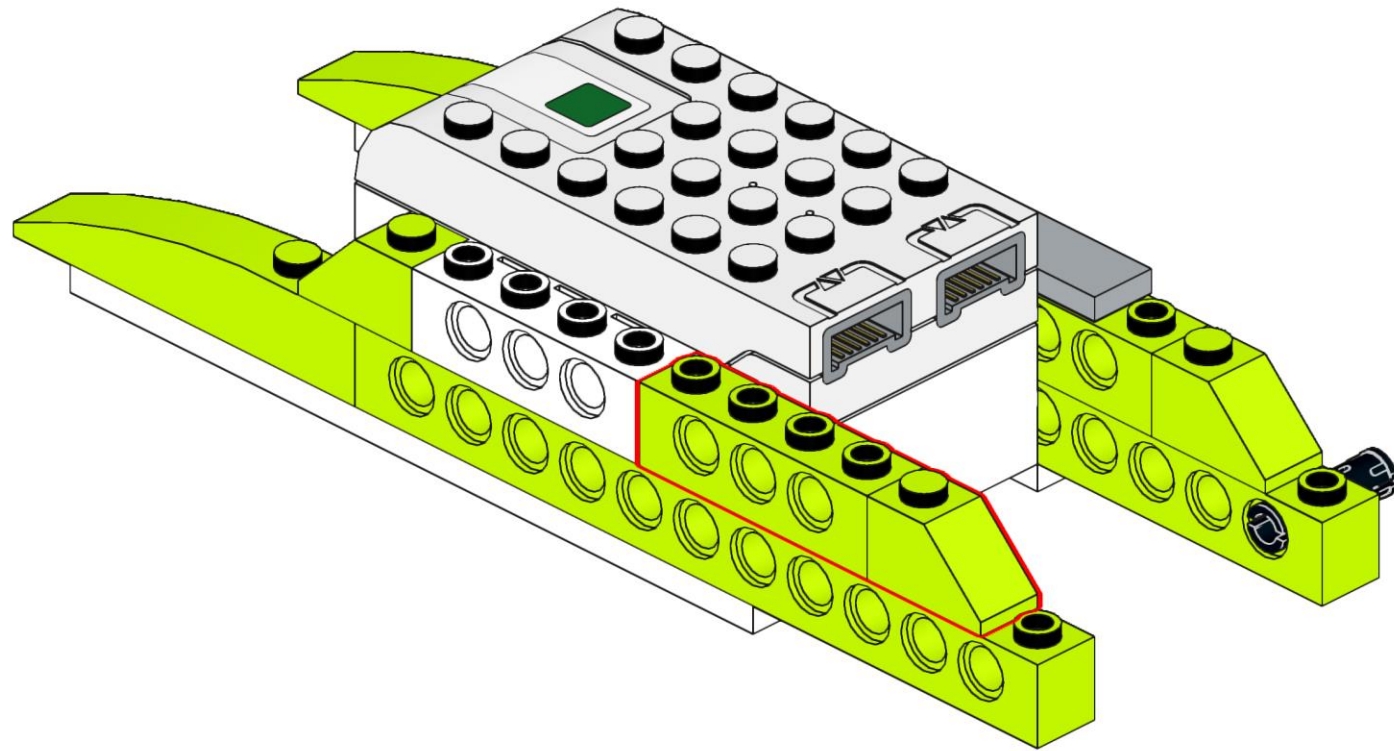
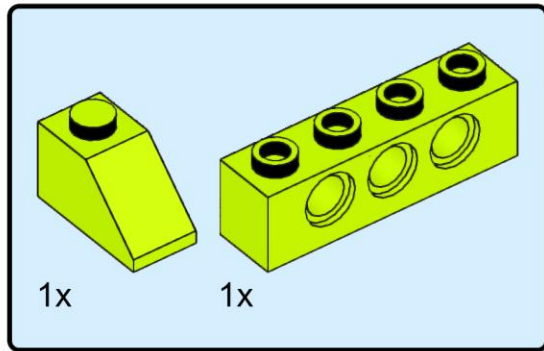

46

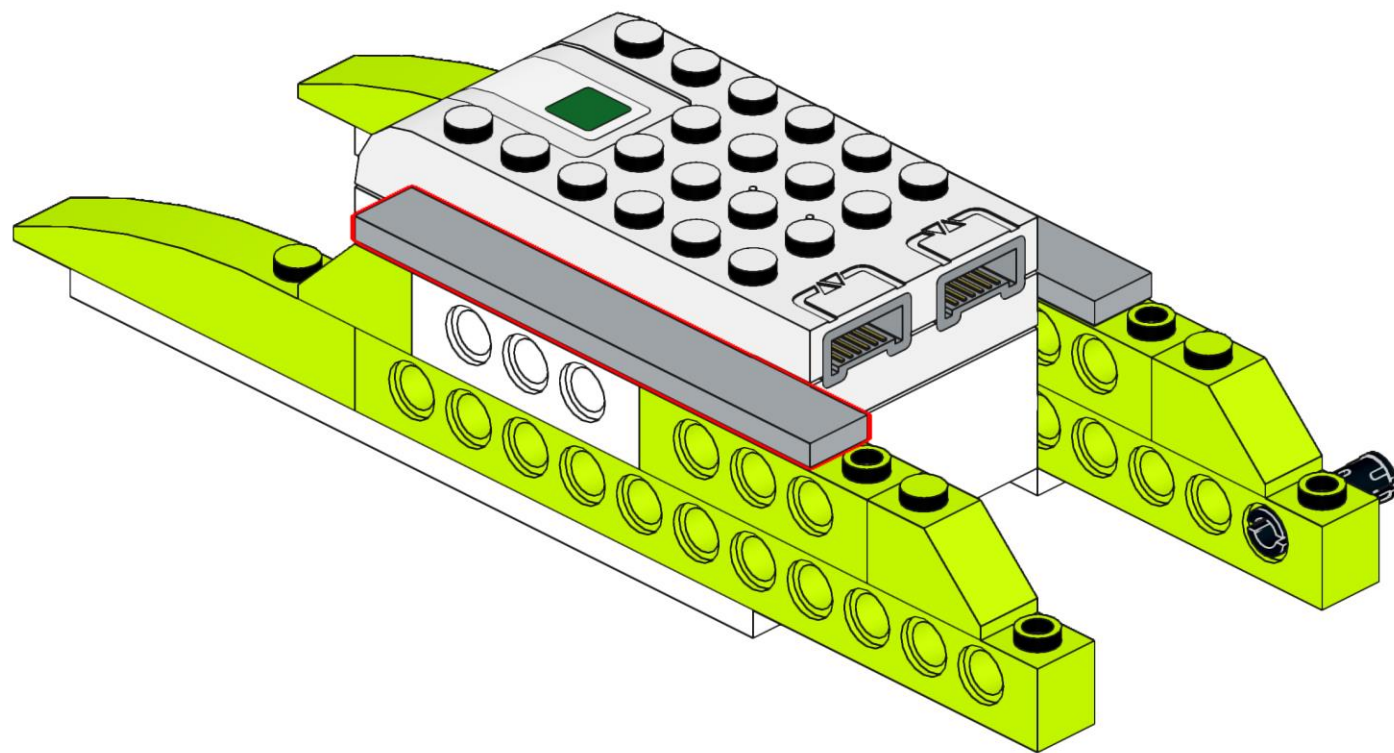
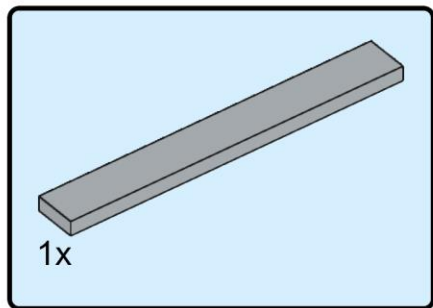

47

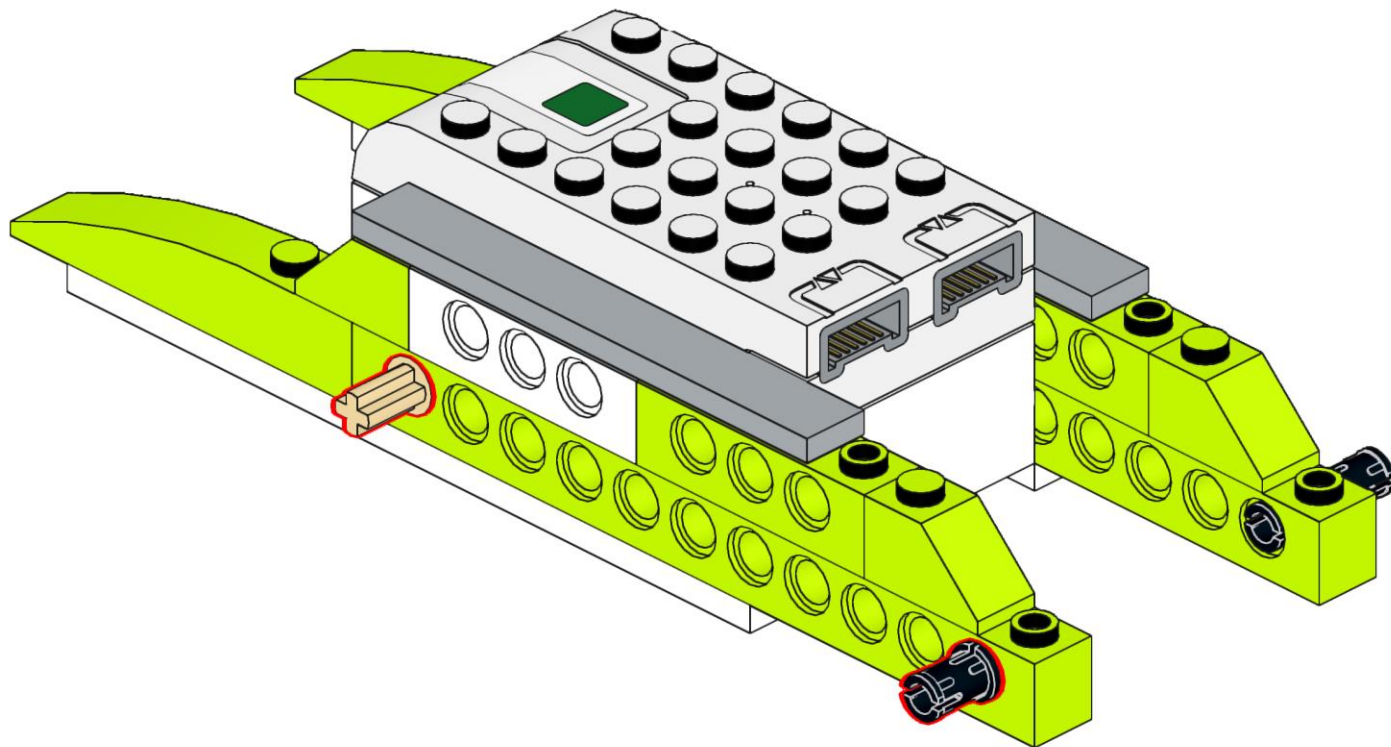
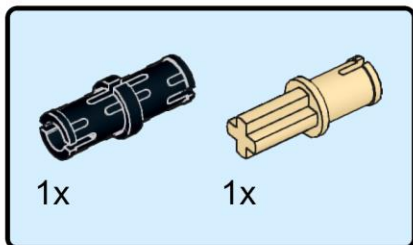

48

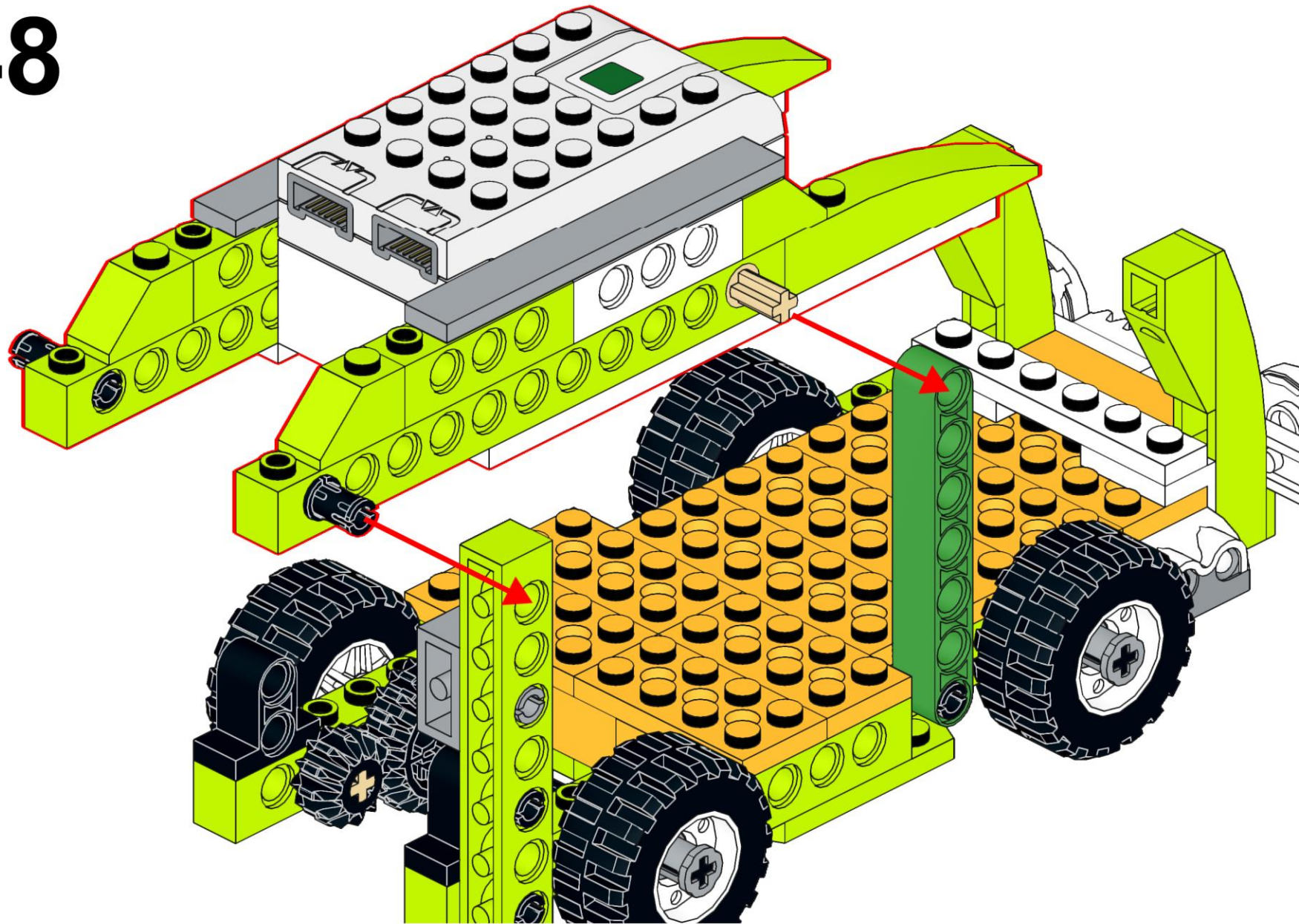

49

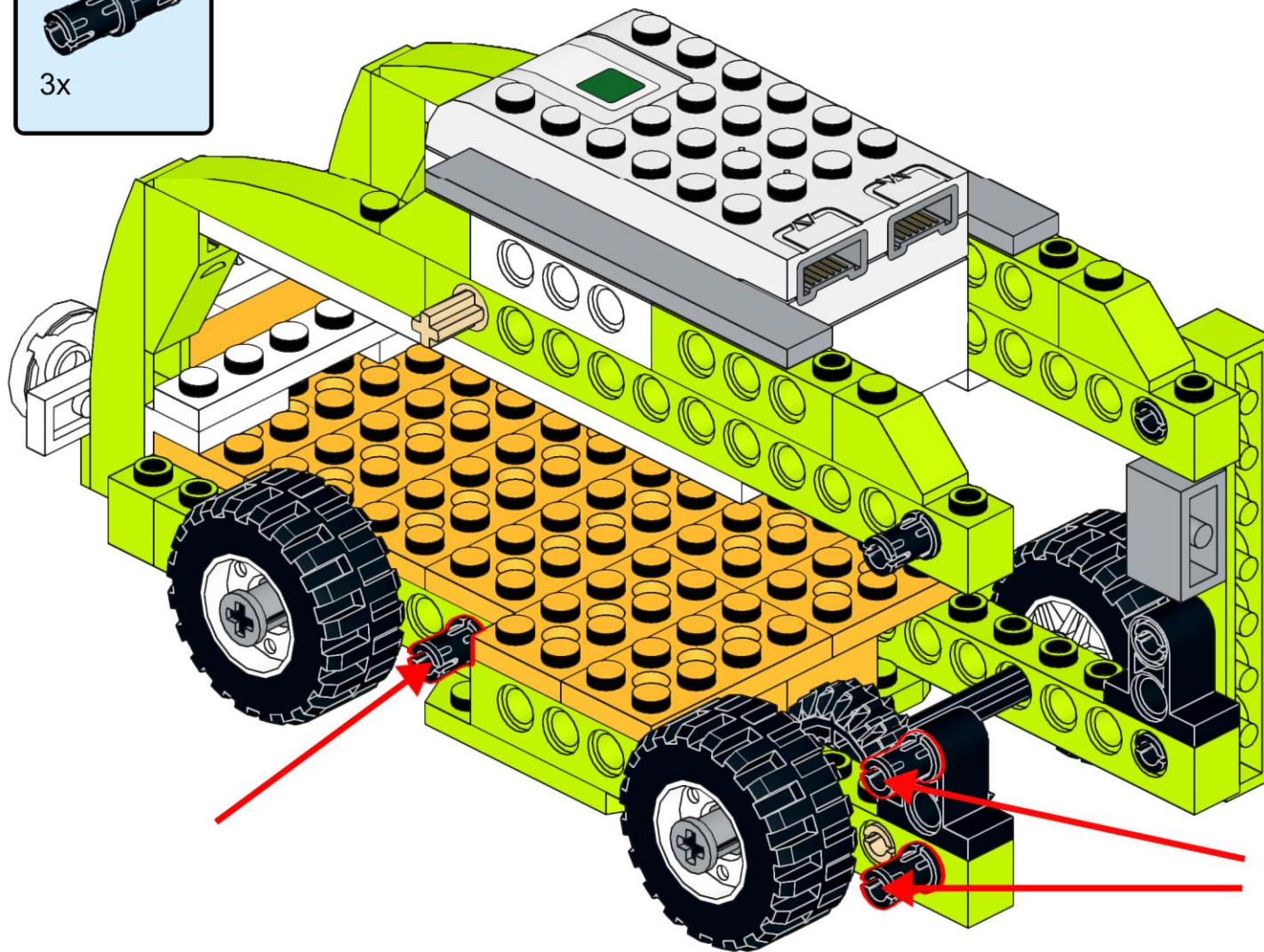
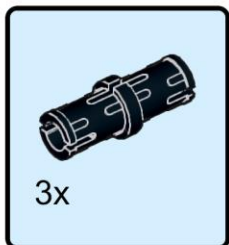

50

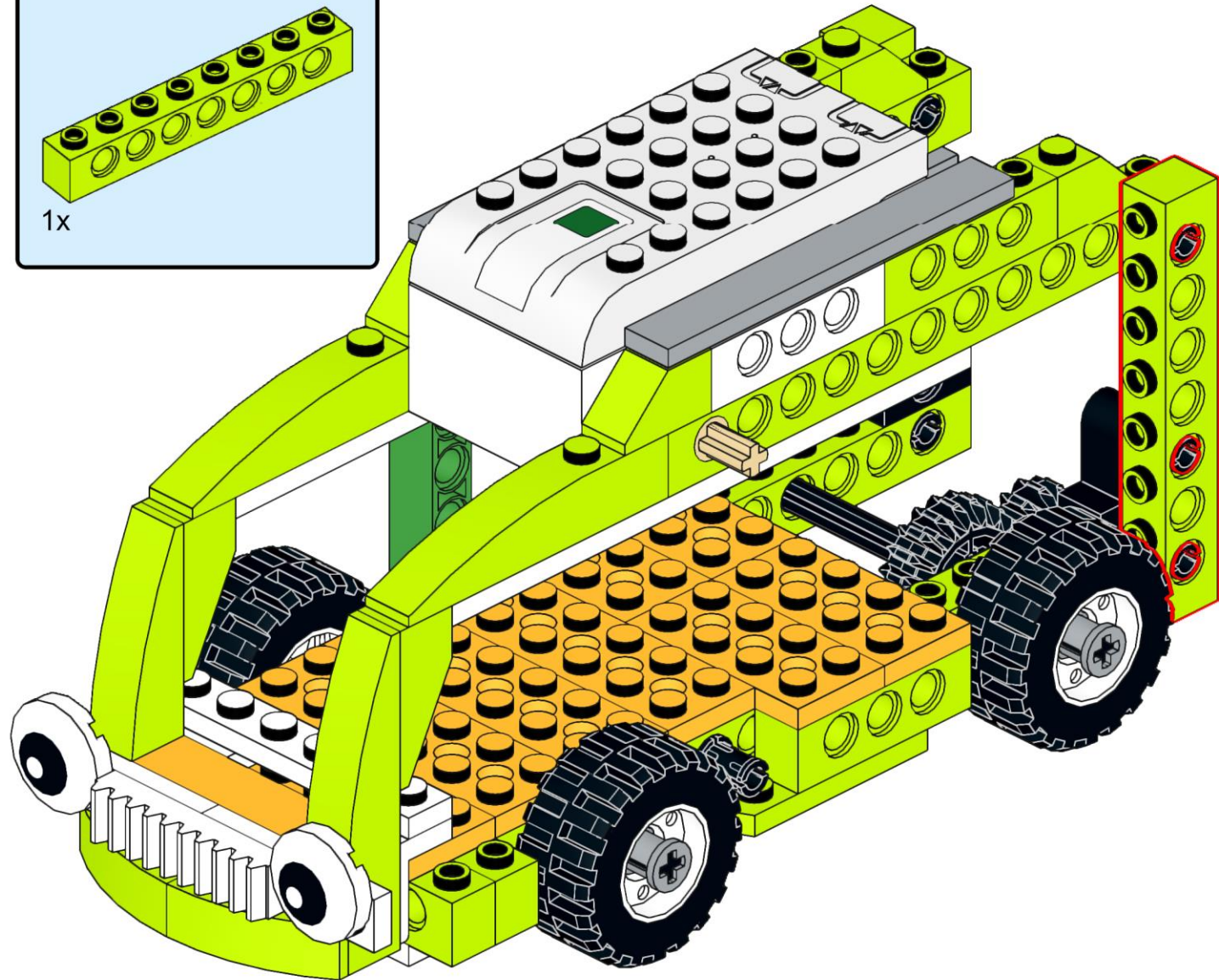
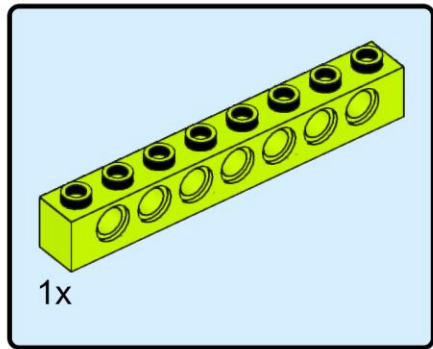

51

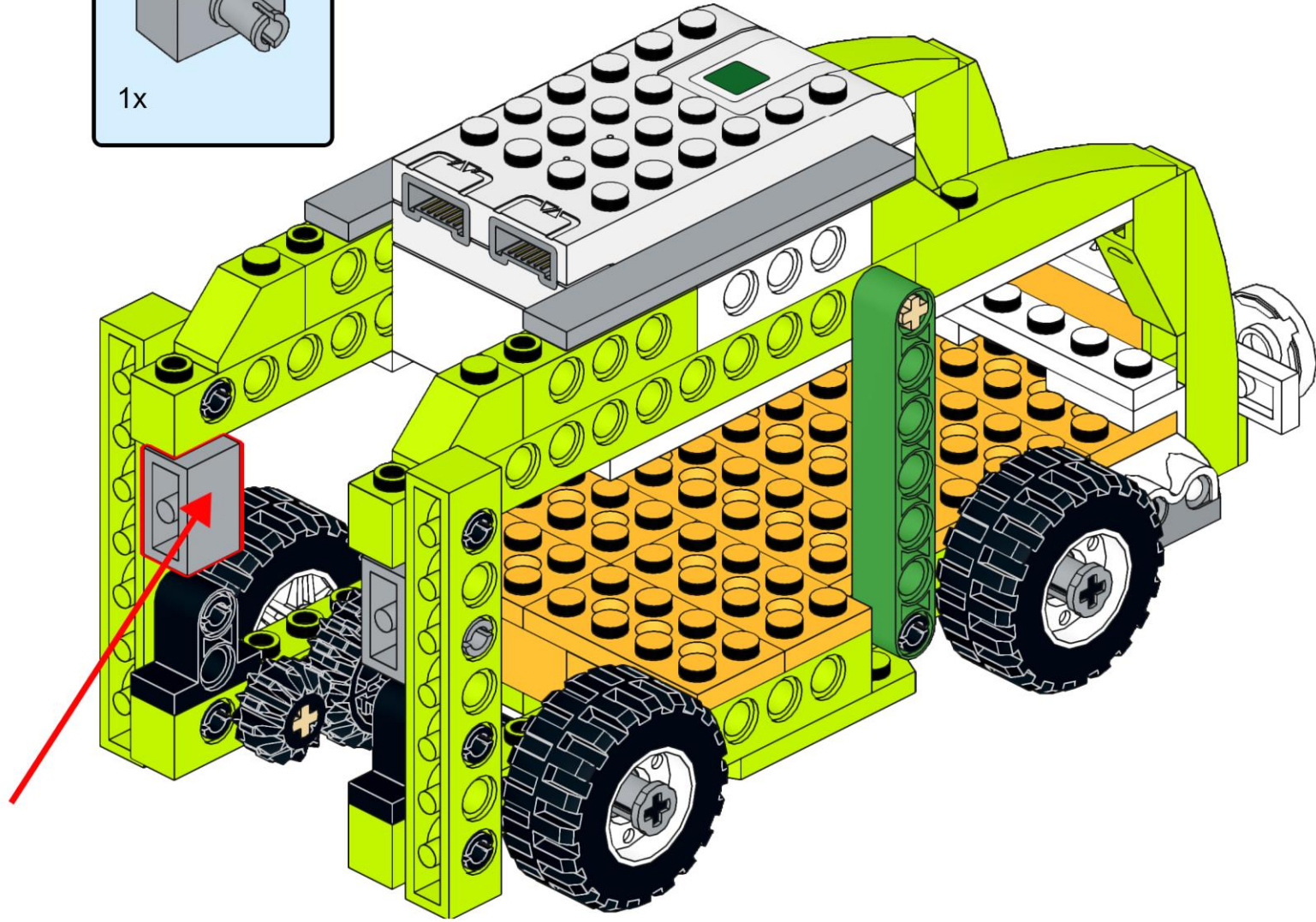
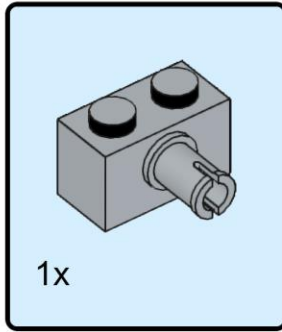

52

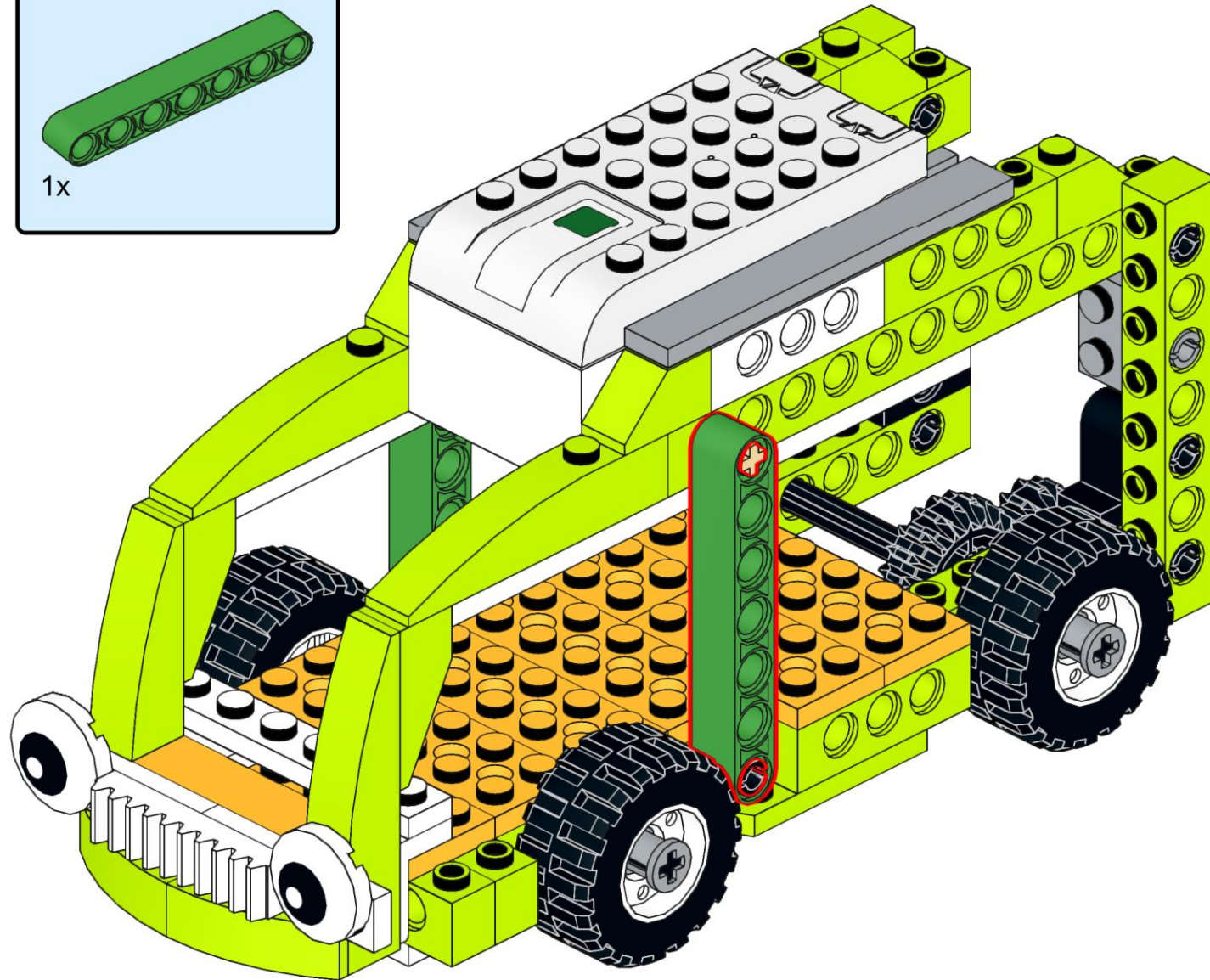
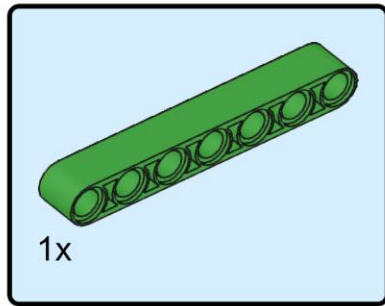

53

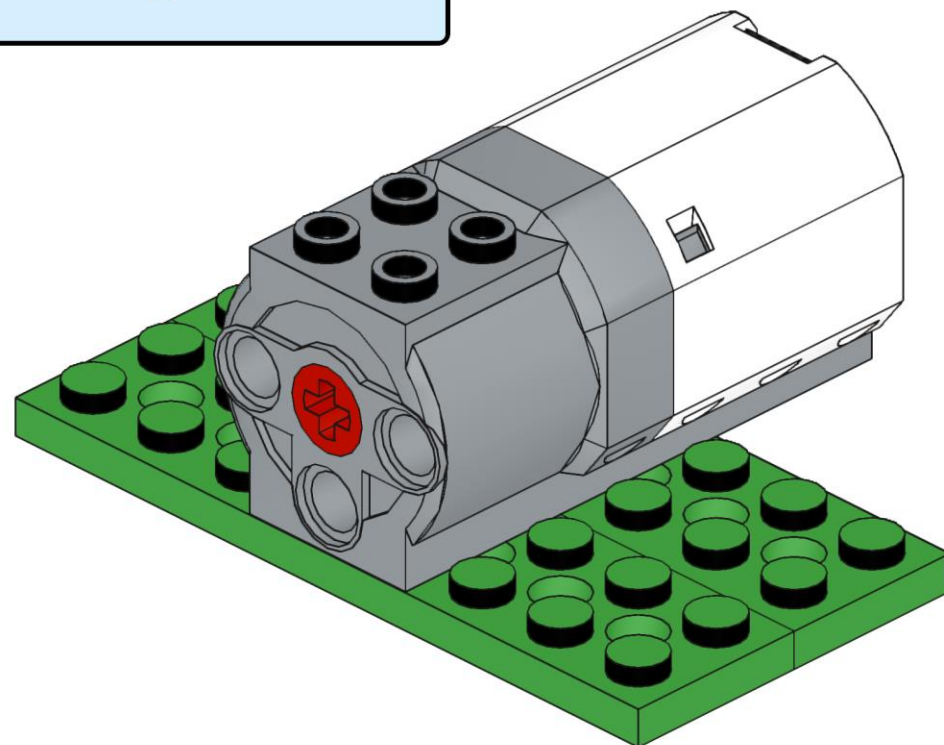
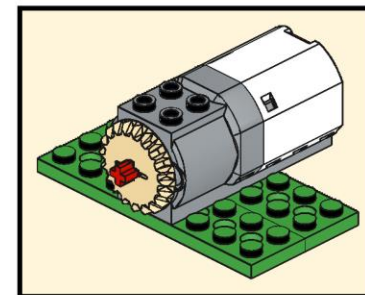
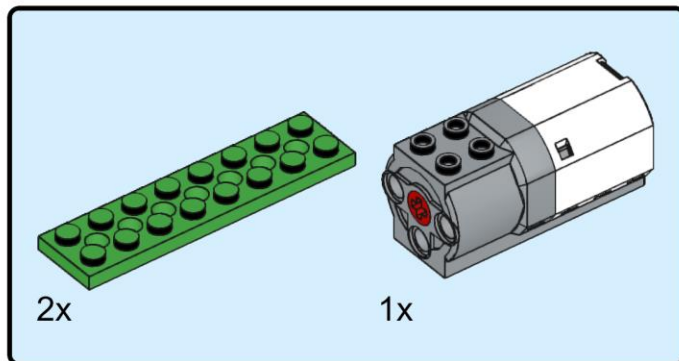

54

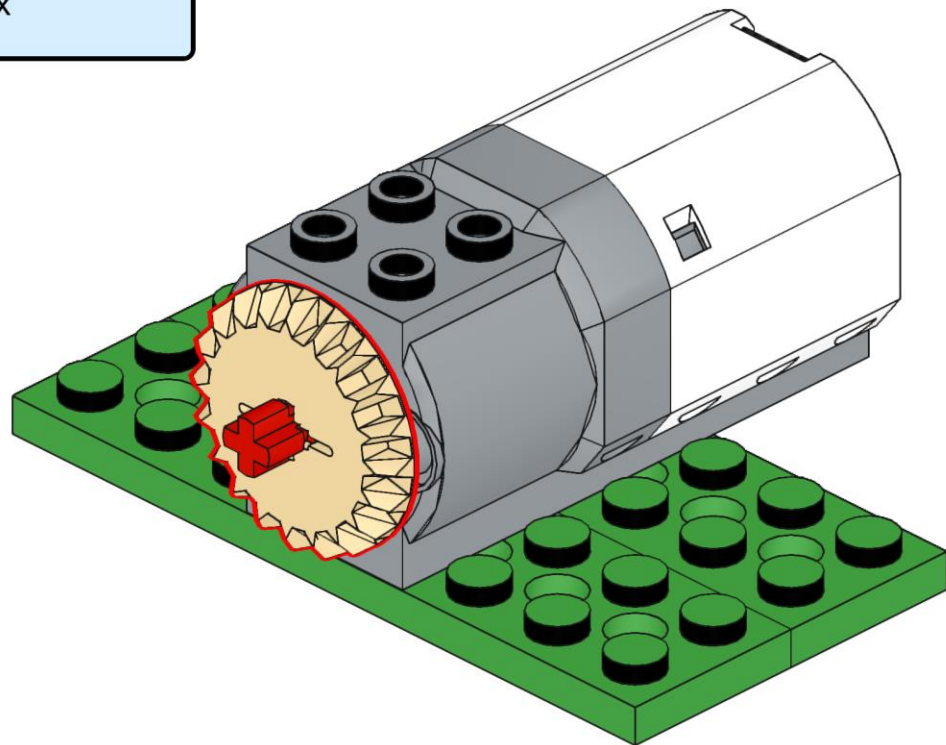
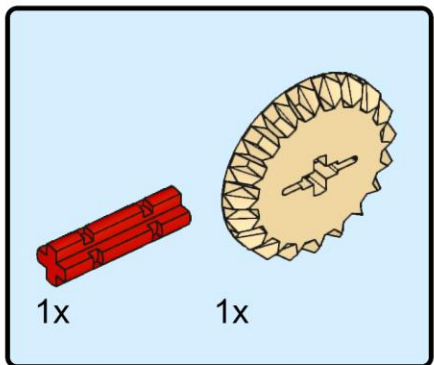

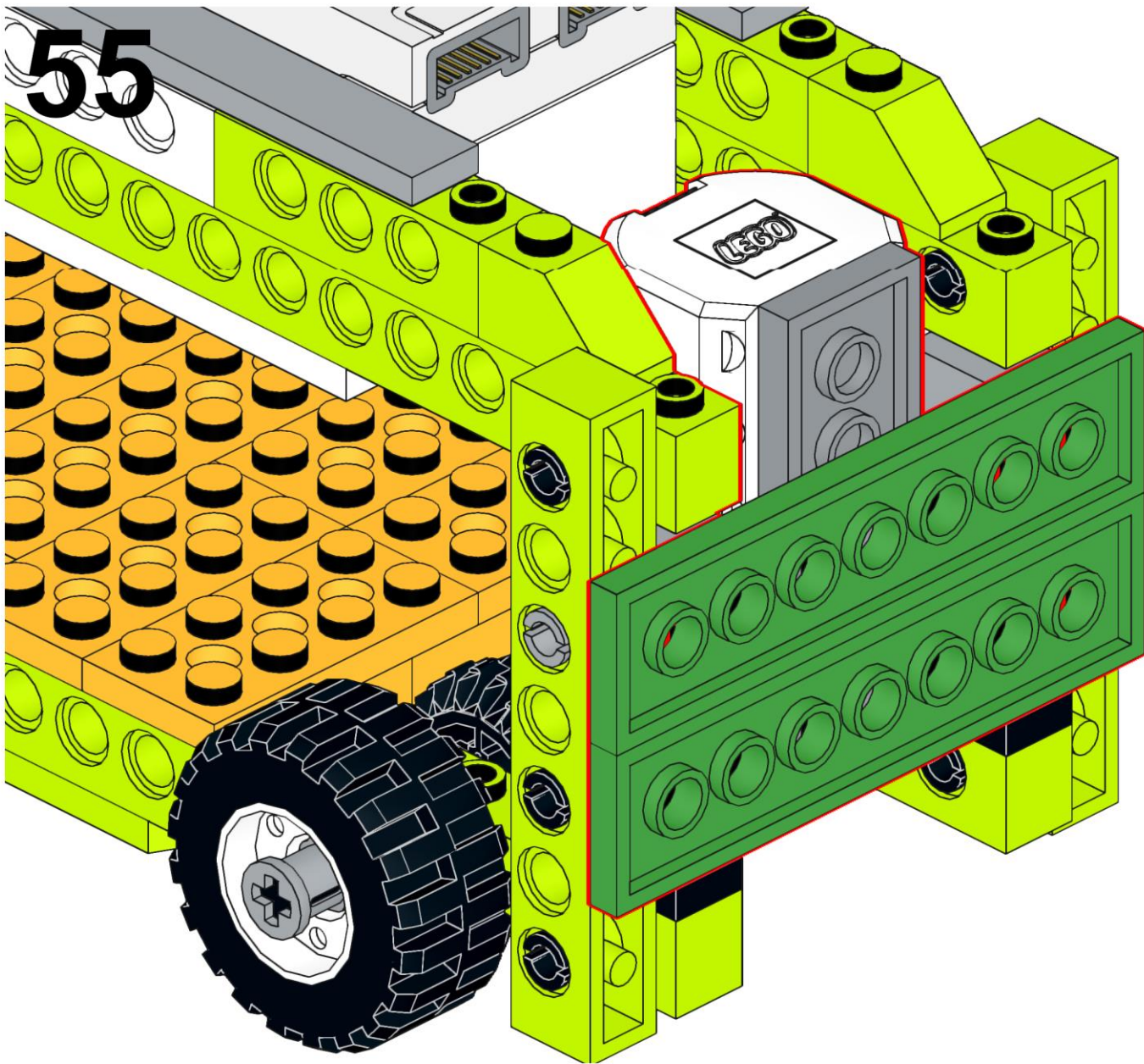

56

