



ИНСТРУКЦИЯ ПО СБОРКЕ ДЛЯ НАБОРА WEDO 2.0

«БАГГИ WIDOW»

WEDO 2.0 «БАГГИ WIDOW»



WEDO 2.0 «БАГГИ WIDOW»

1

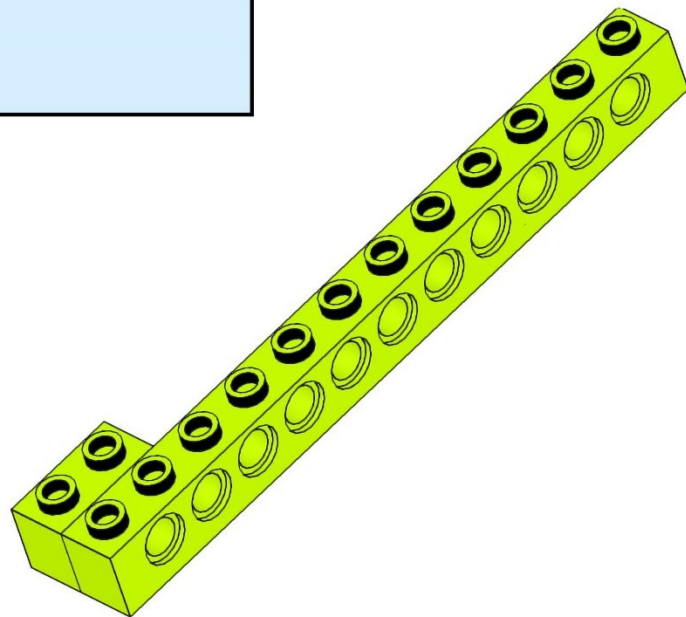
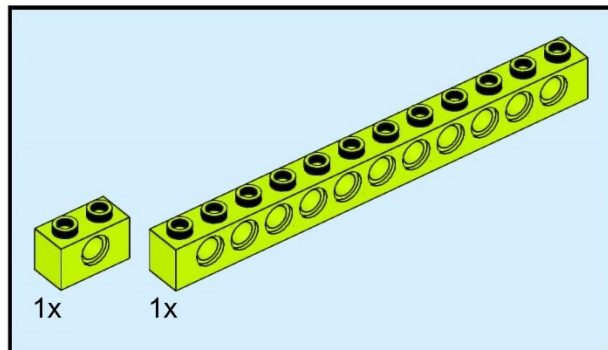

WEDO 2.0 «БАГГИ WIDOW»

2

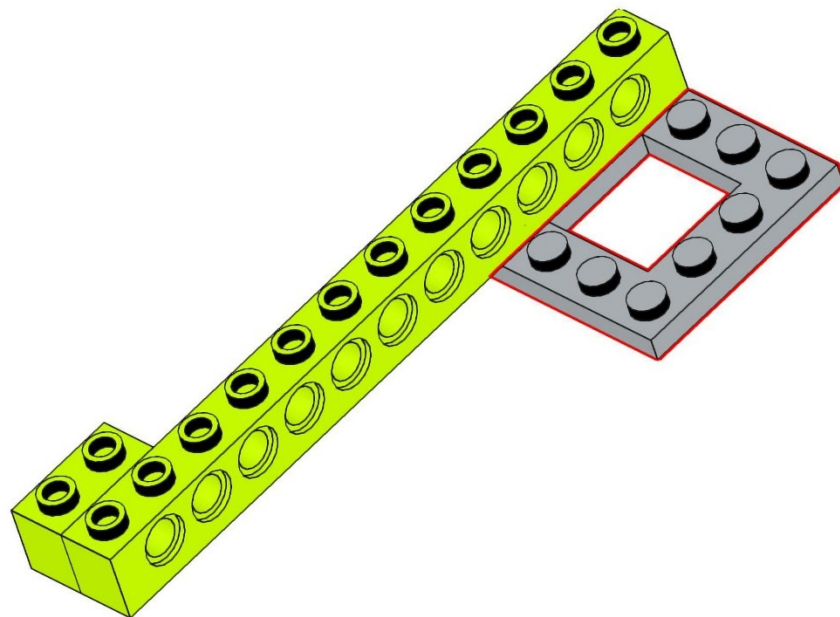
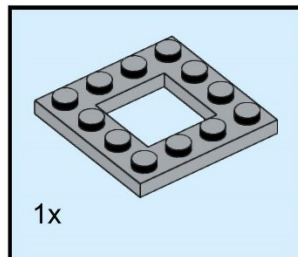

WEDO 2.0 «БАГГИ WIDOW»

3

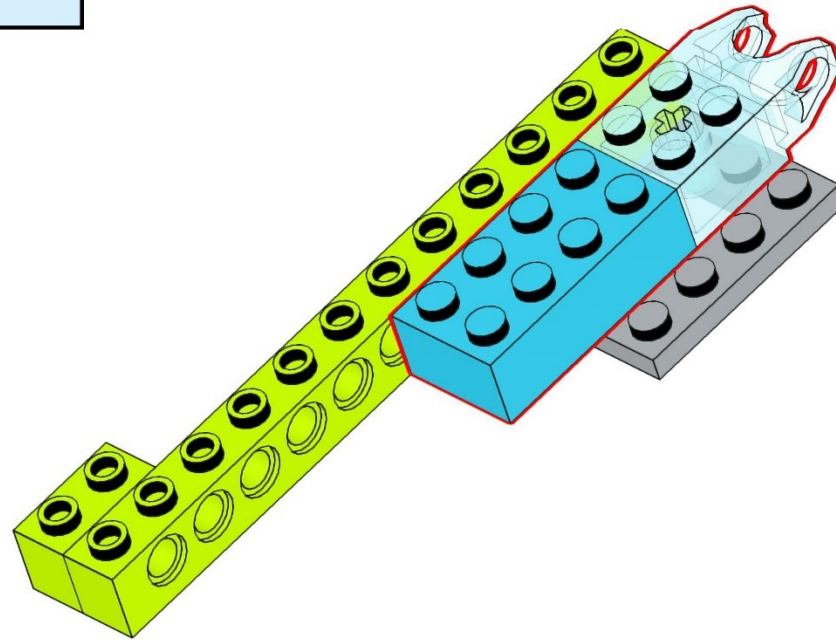
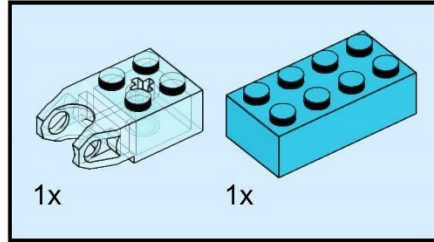

WEDO 2.0 «БАГГИ WIDOW»

4

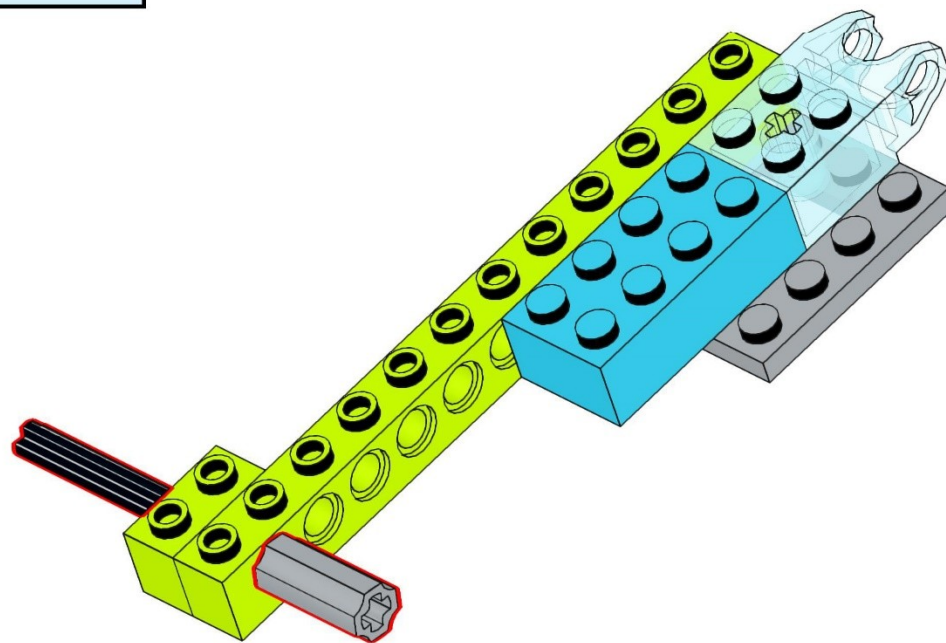
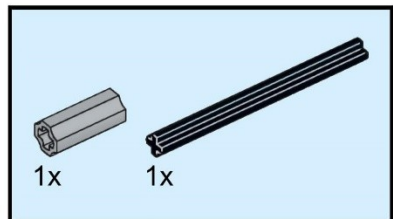

WEDO 2.0 «БАГГИ WIDOW»

5

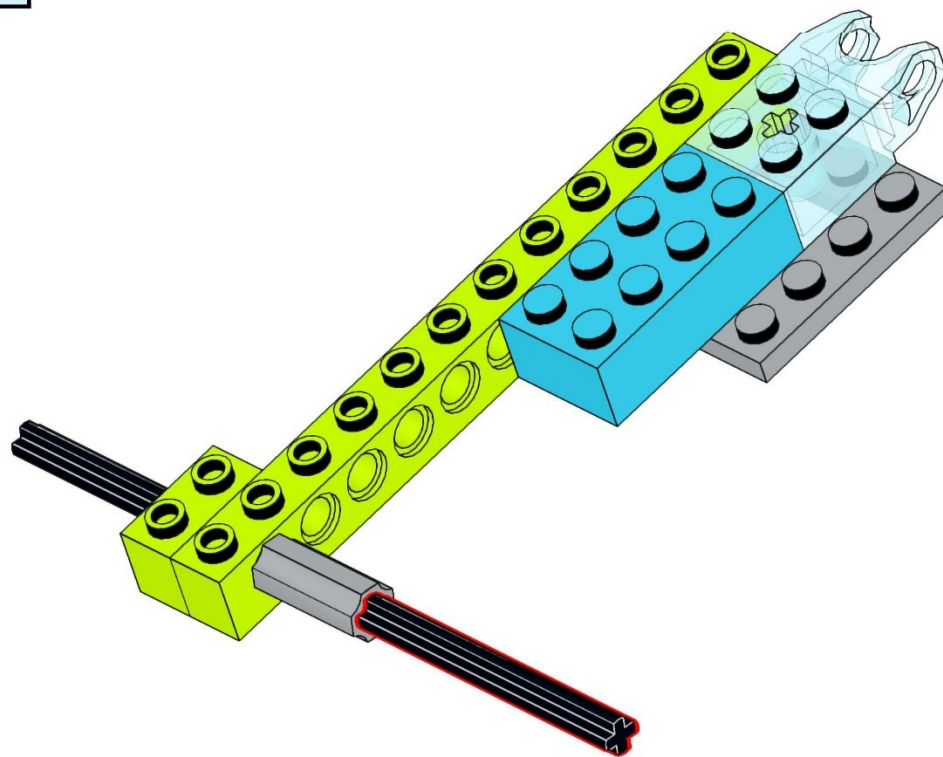
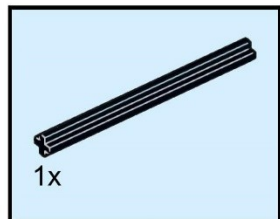

WEDO 2.0 «БАГГИ WIDOW»

6

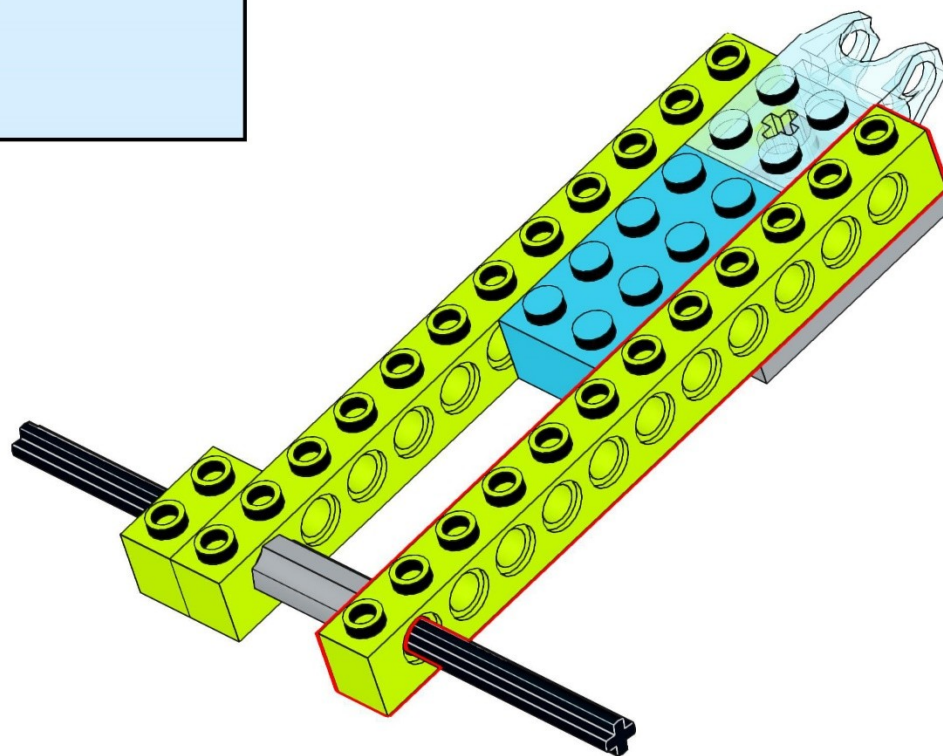
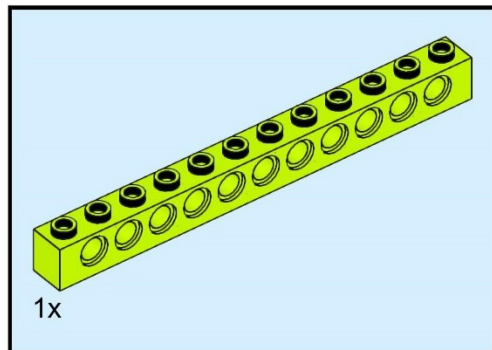

WEDO 2.0 «БАГГИ WIDOW»

7

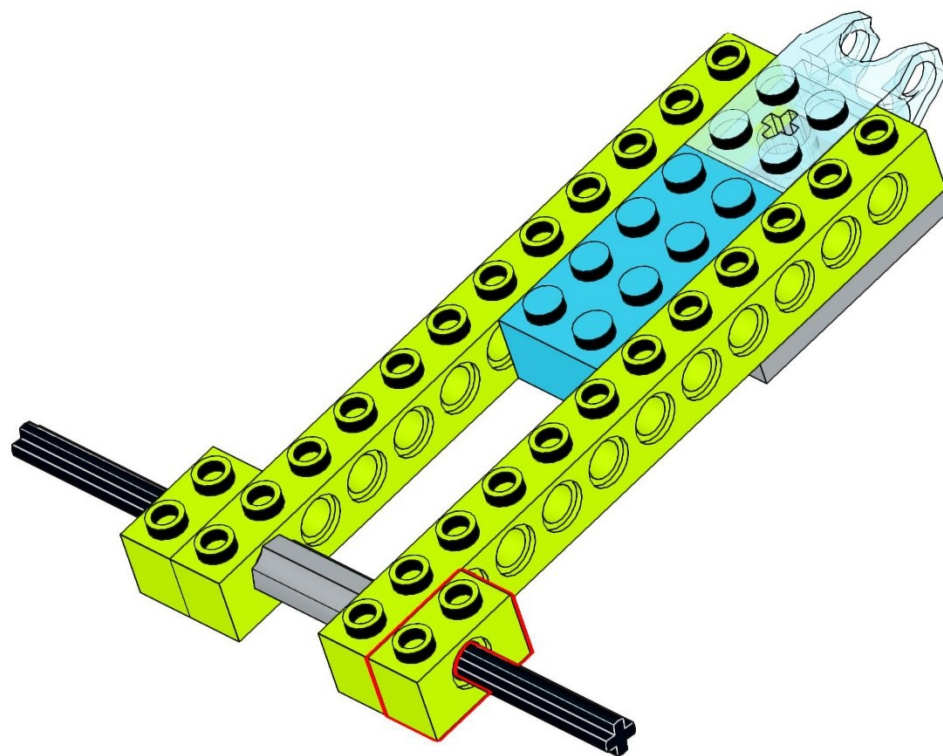
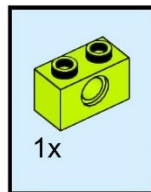

WEDO 2.0 «БАГГИ WIDOW»

8

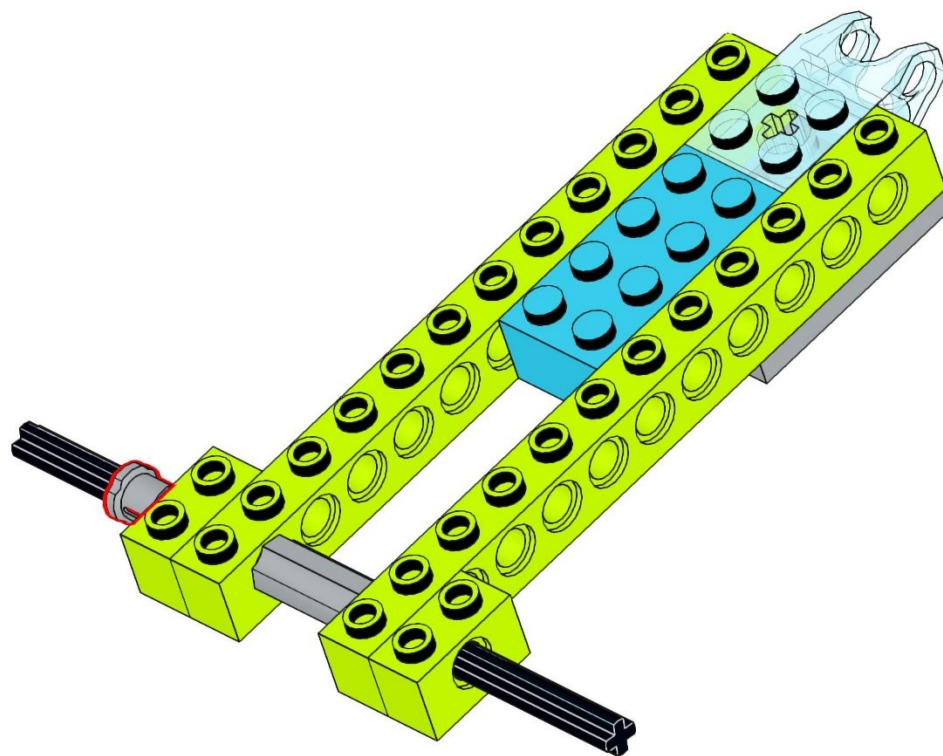
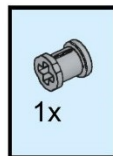

WEDO 2.0 «БАГГИ WIDOW»

9

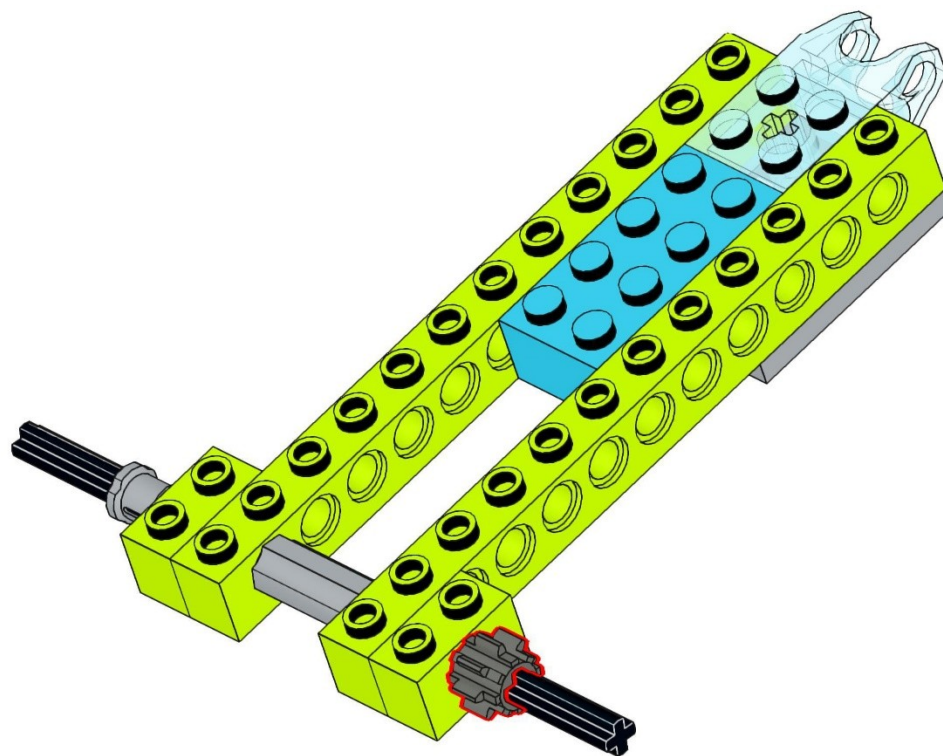
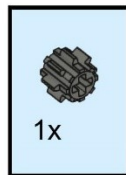

WEDO 2.0 «БАГГИ WIDOW»

10

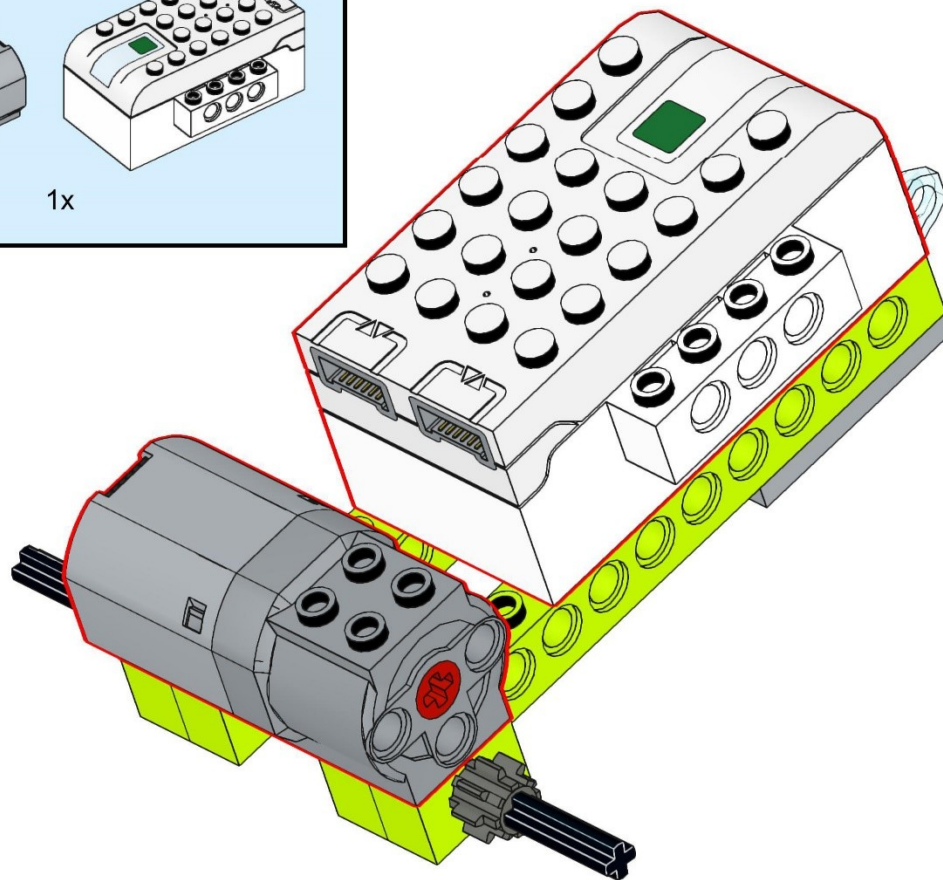
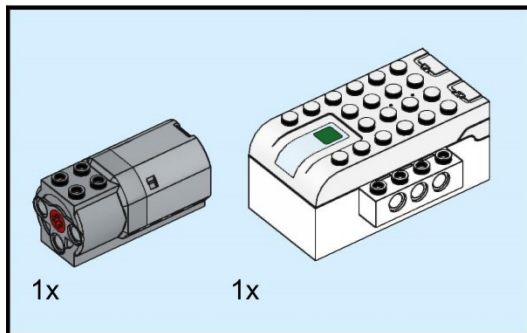

WEDO 2.0 «БАГГИ WIDOW»

11

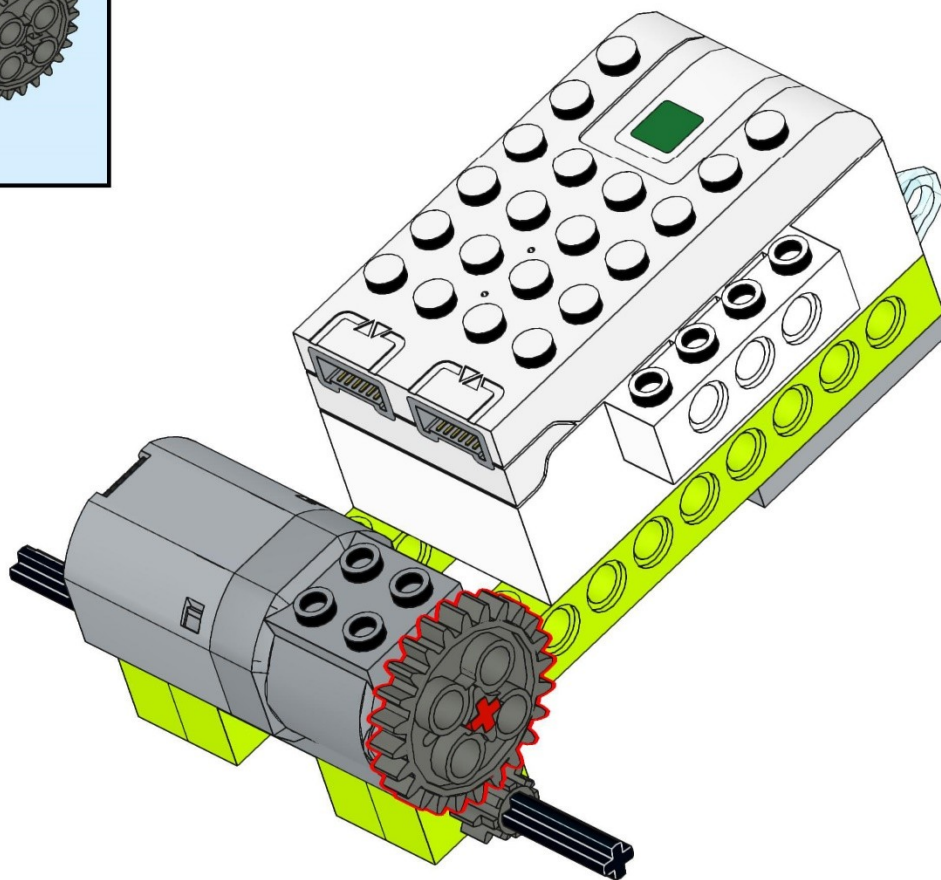
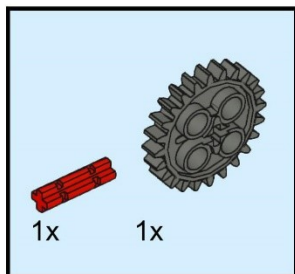

WEDO 2.0 «БАГГИ WIDOW»

12

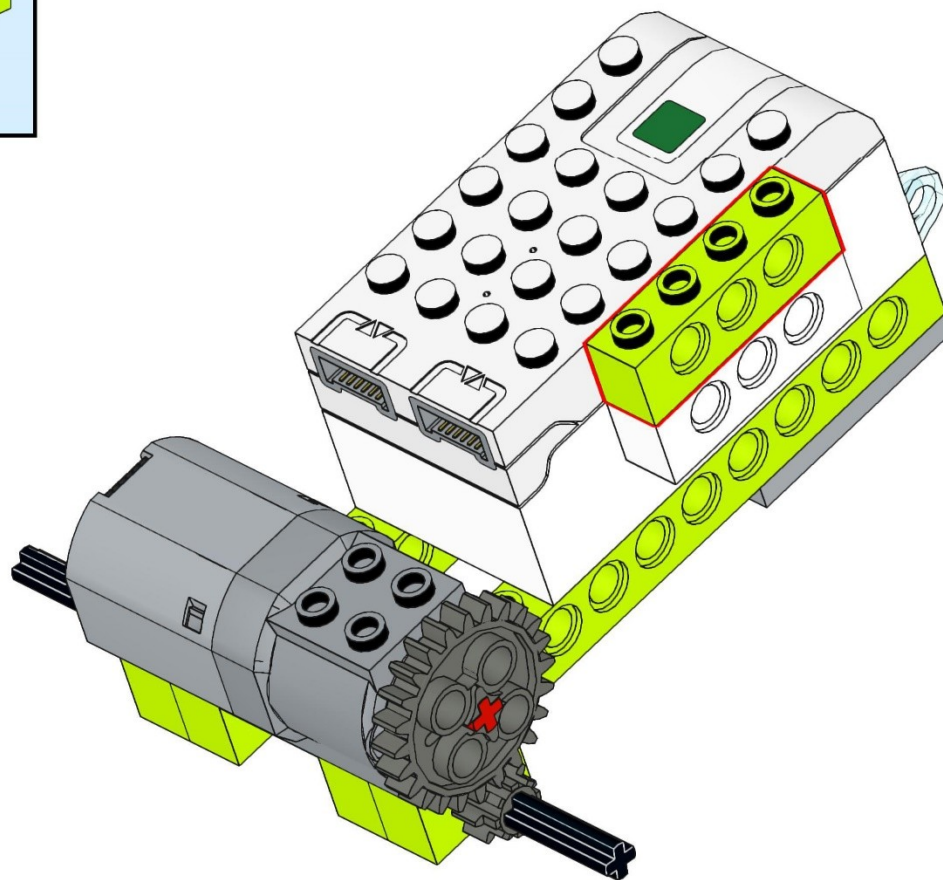
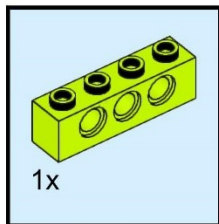

WEDO 2.0 «БАГГИ WIDOW»

13

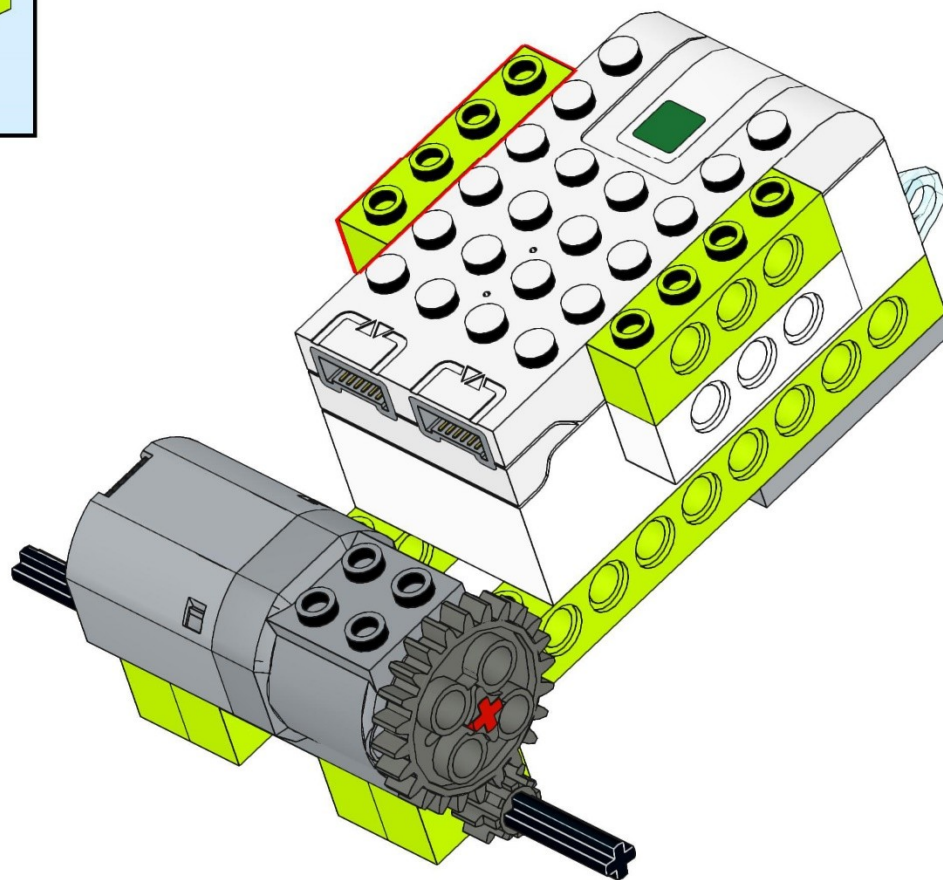
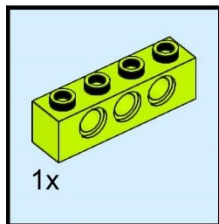

WEDO 2.0 «БАГГИ WIDOW»

14

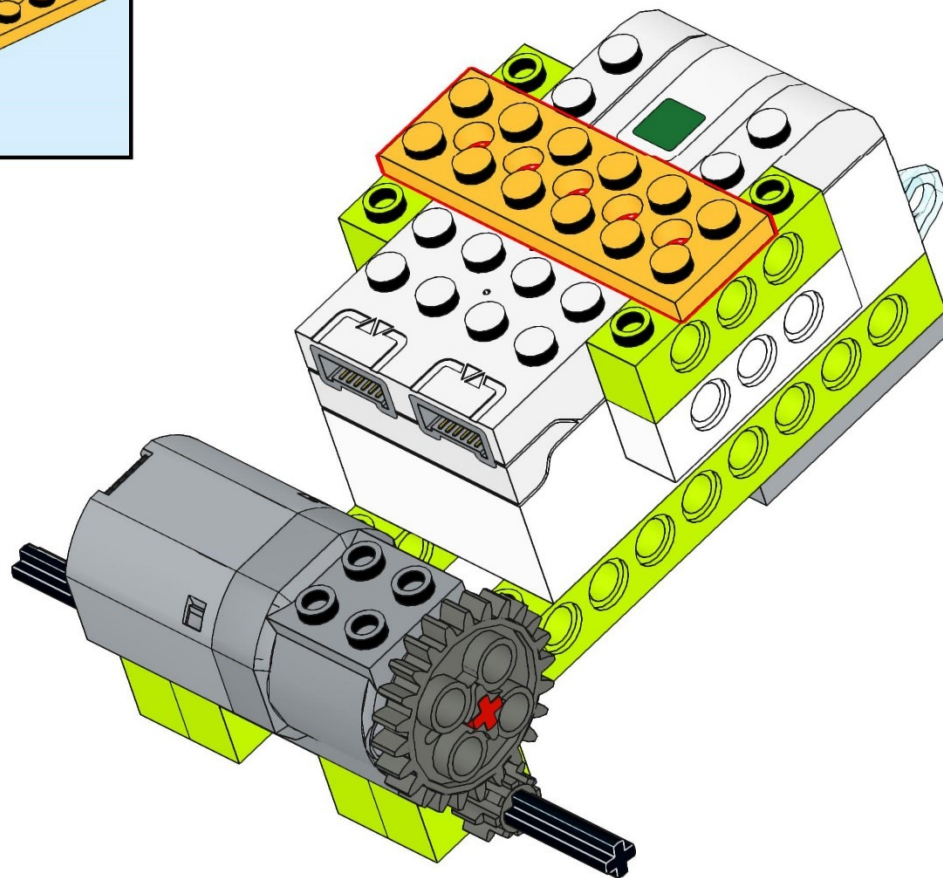
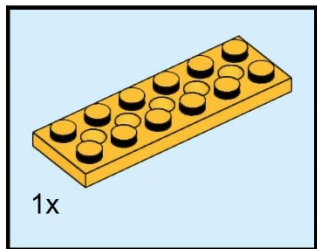

WEDO 2.0 «БАГГИ WIDOW»

15

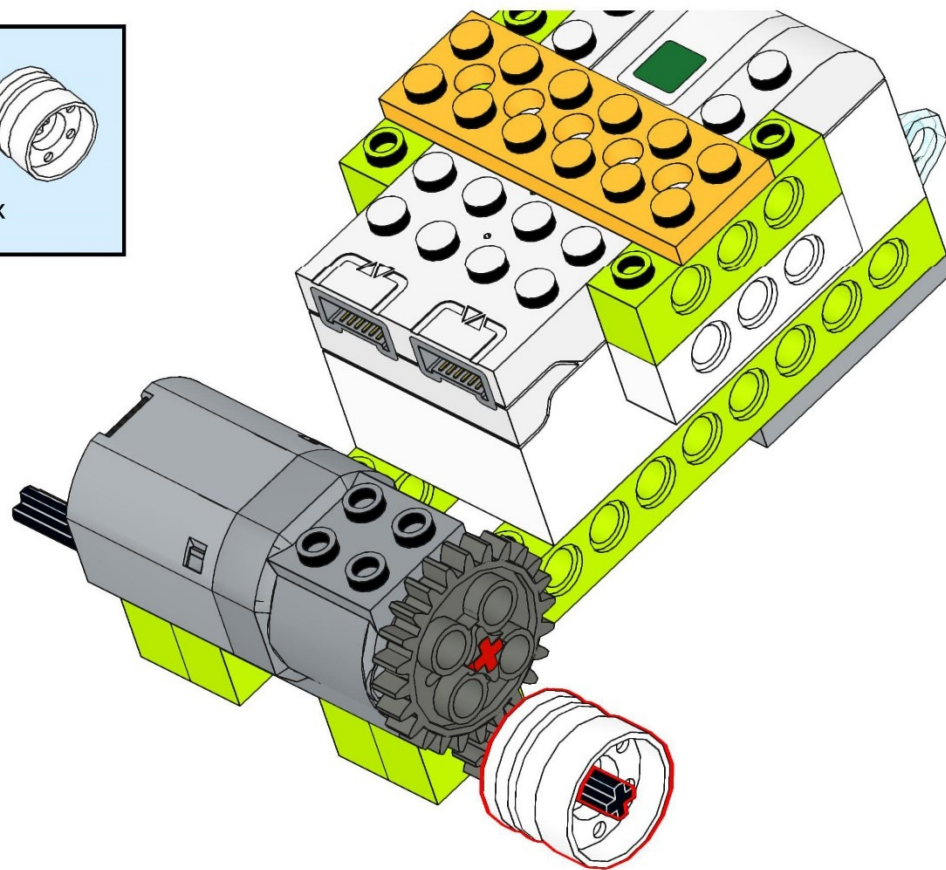
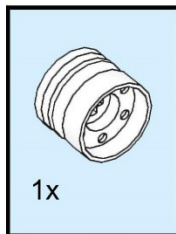

WEDO 2.0 «БАГГИ WIDOW»

16

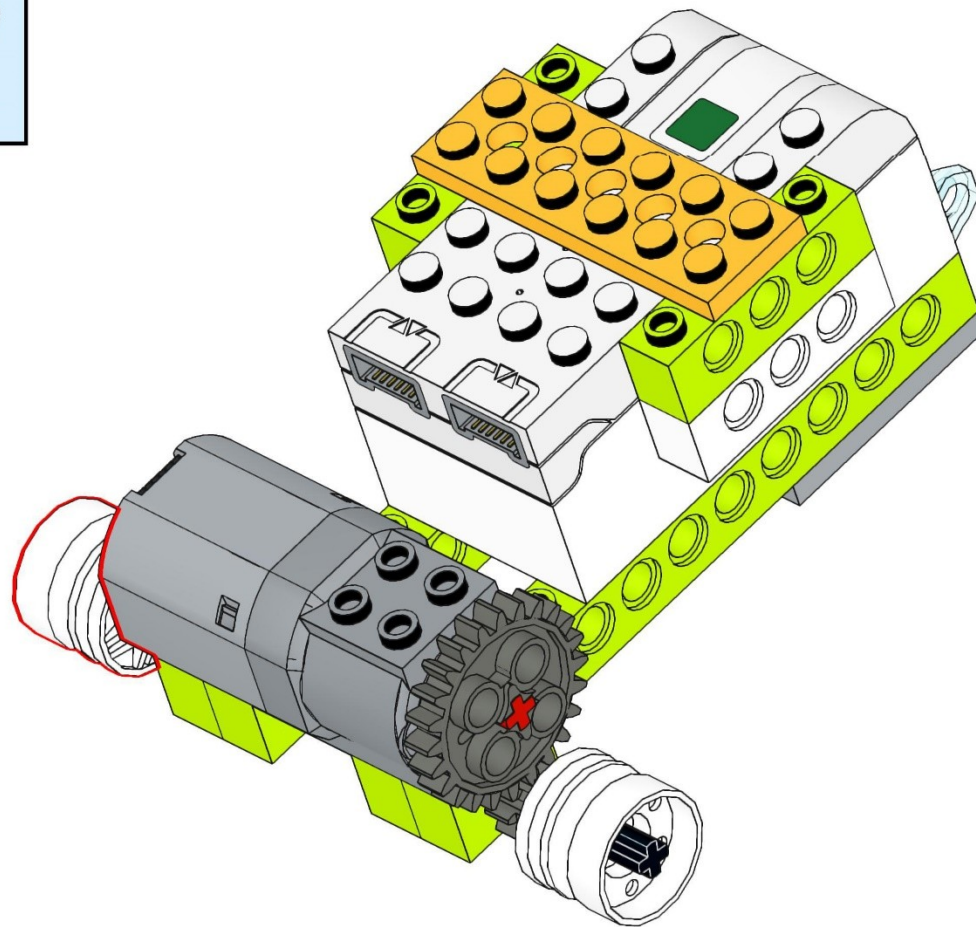
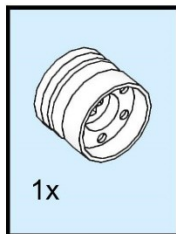

WEDO 2.0 «БАГГИ WIDOW»

17

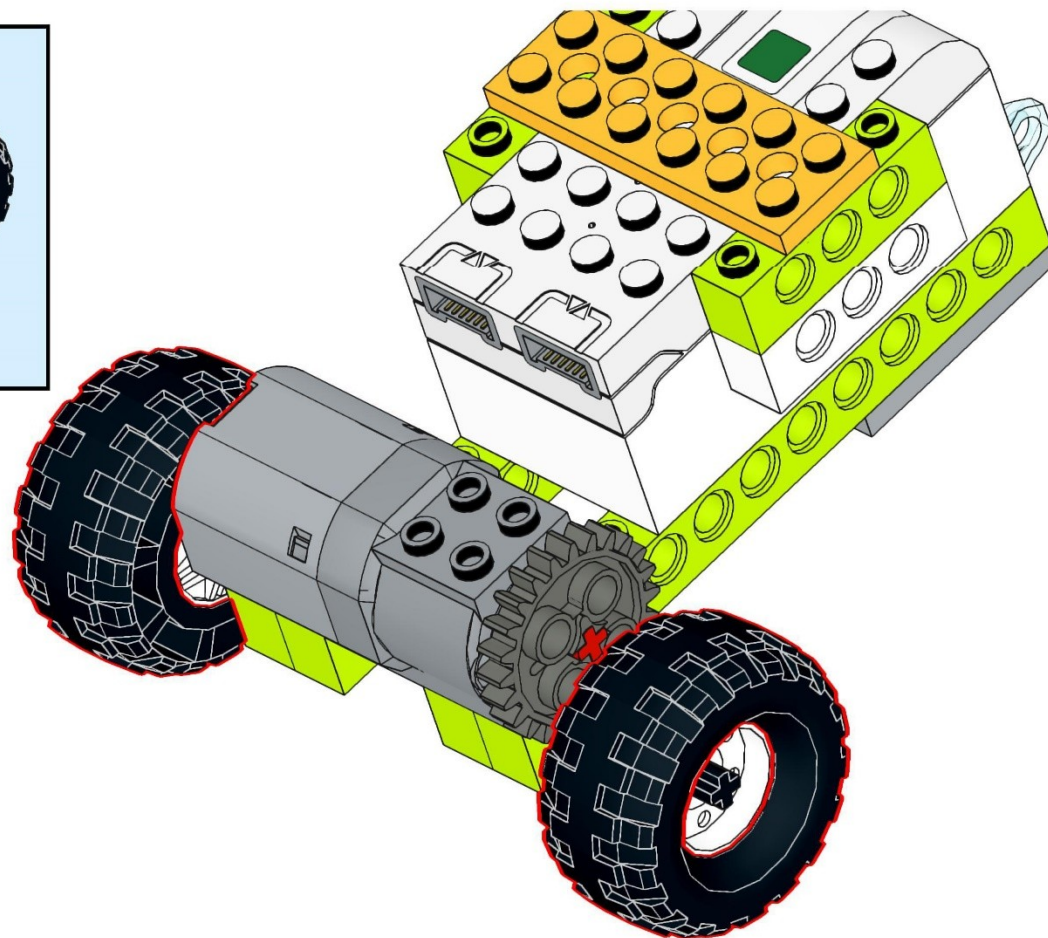
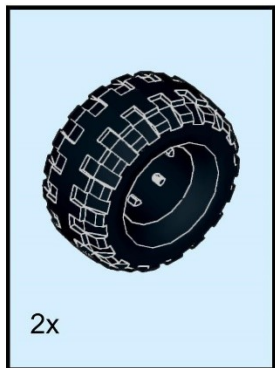

WEDO 2.0 «БАГГИ WIDOW»

18

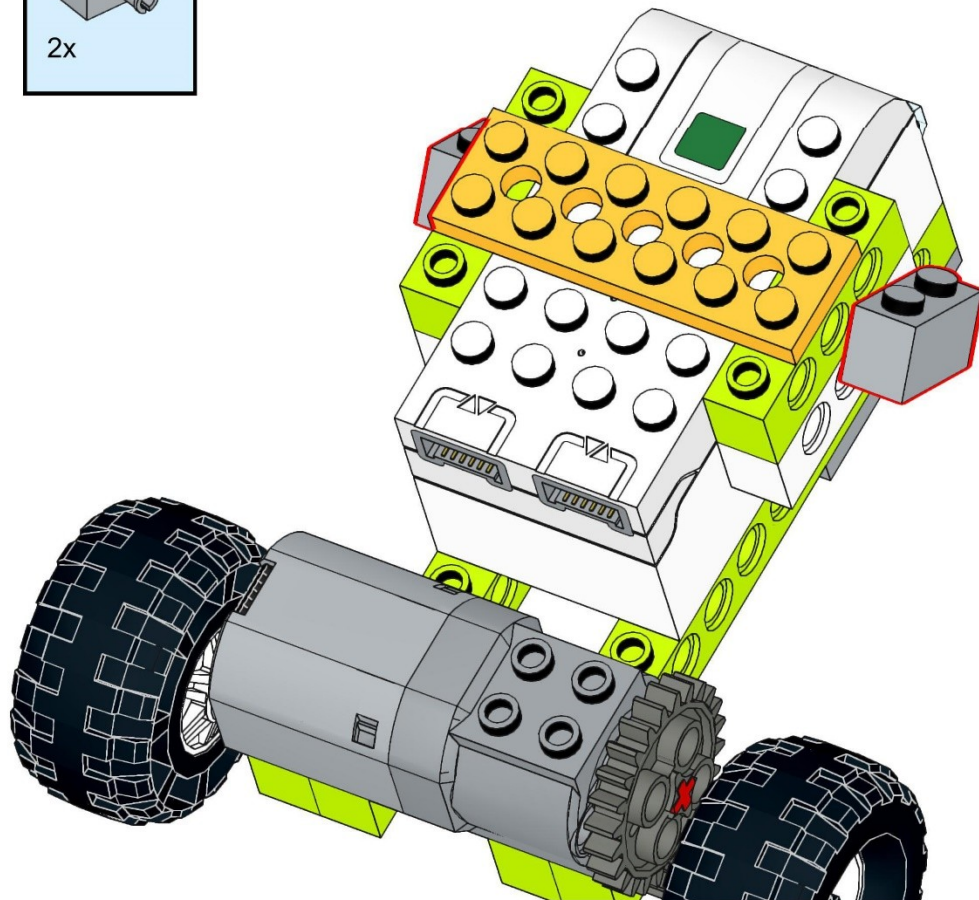
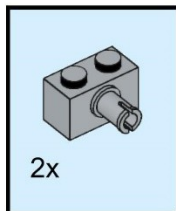

WEDO 2.0 «БАГГИ WIDOW»

19

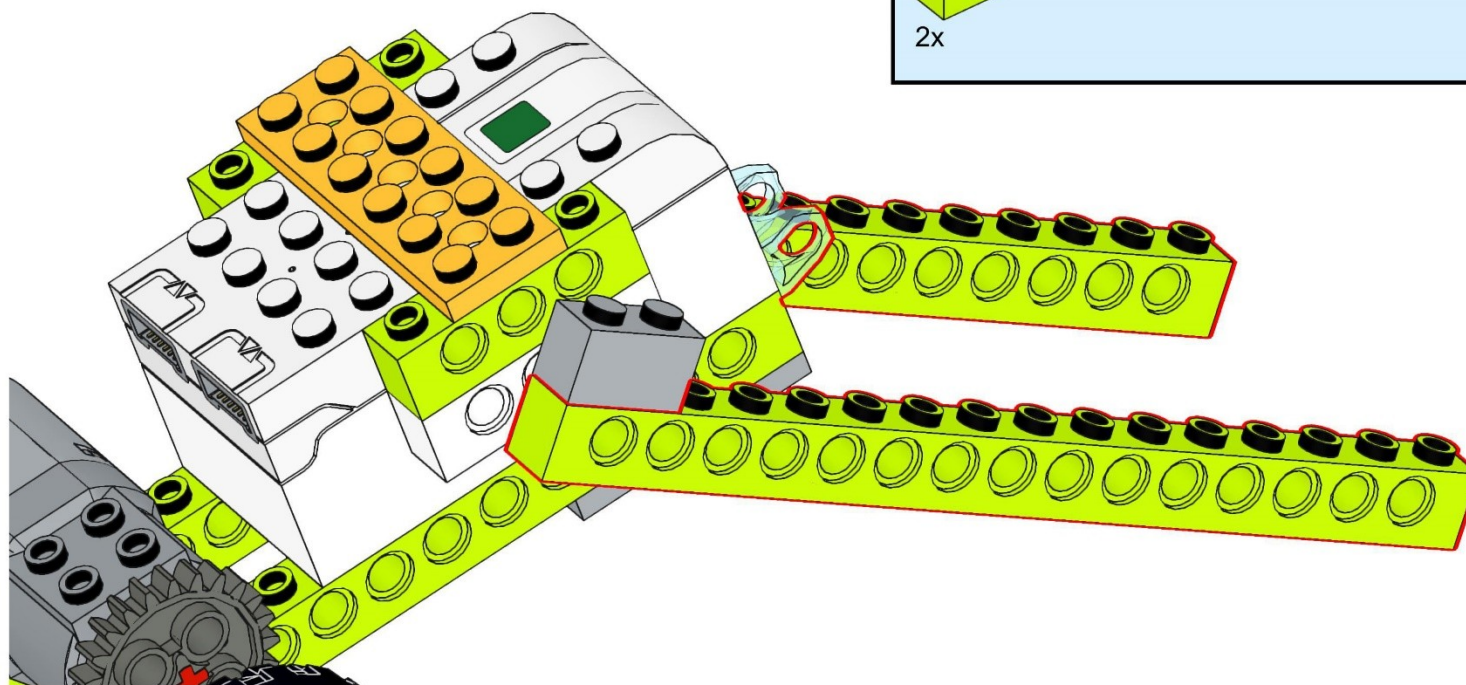
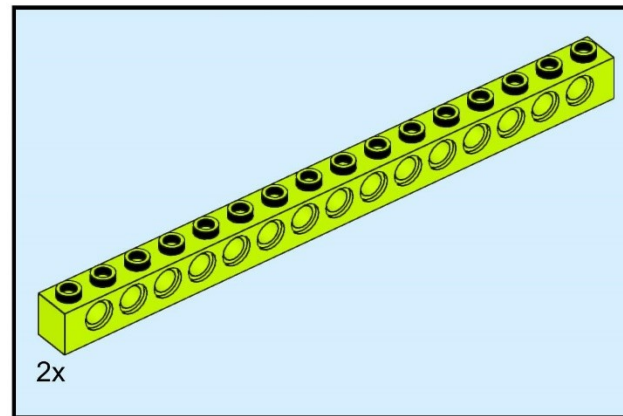

WEDO 2.0 «БАГГИ WIDOW»

20

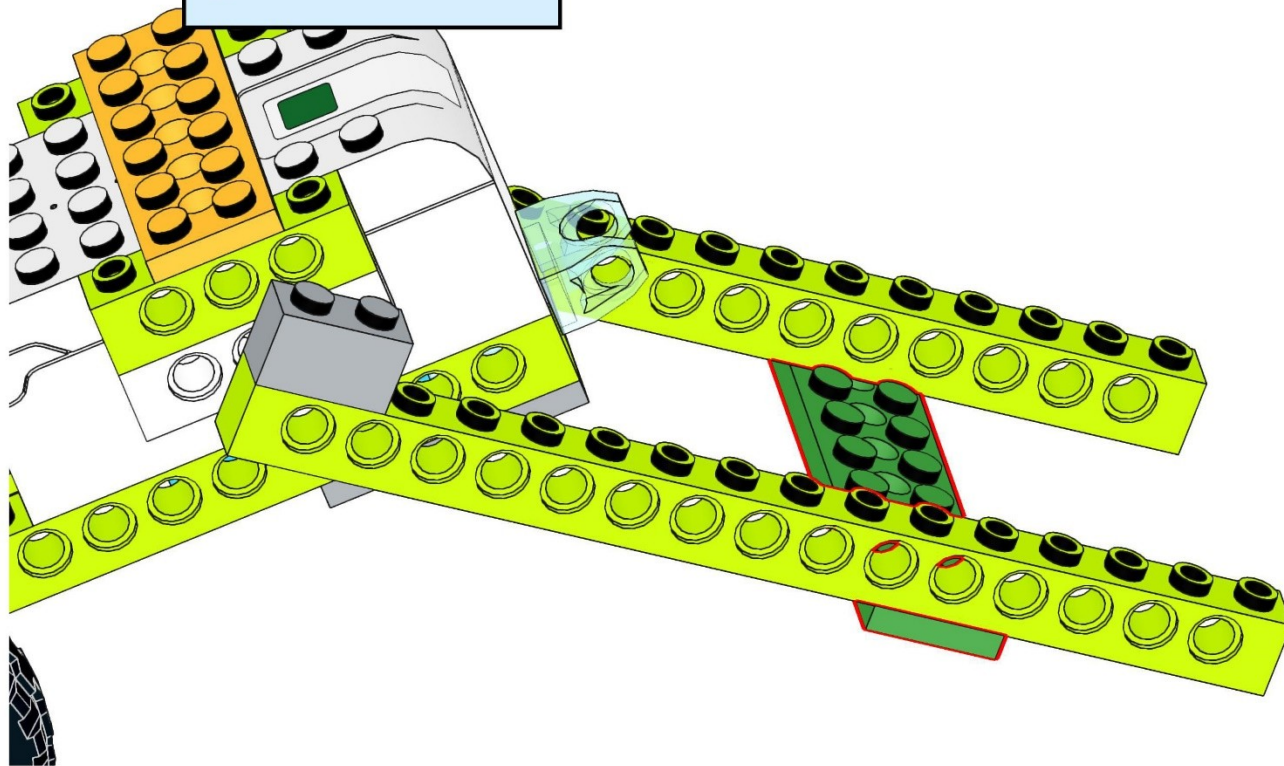
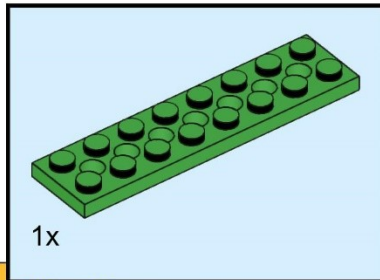

WEDO 2.0 «БАГГИ WIDOW»

21

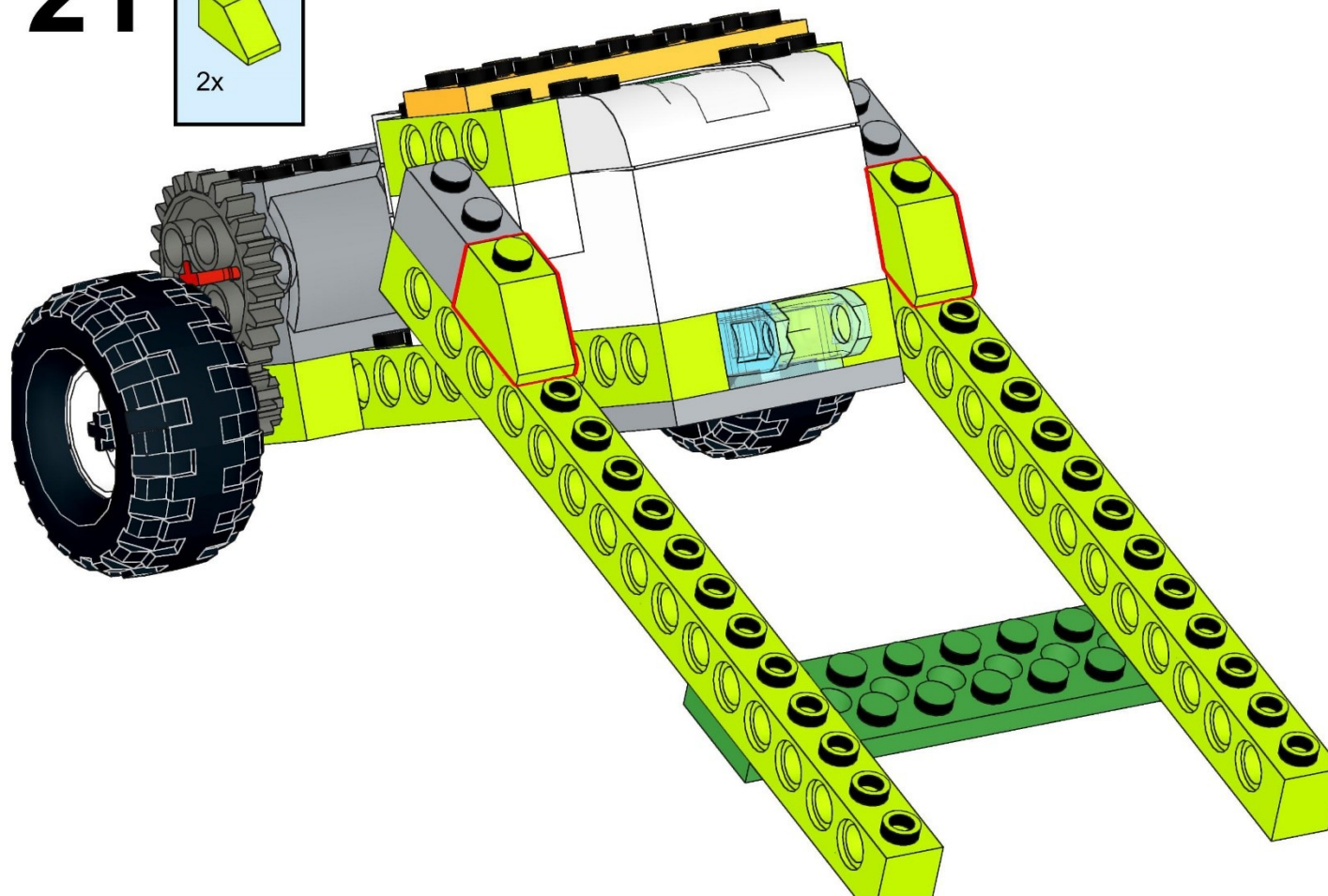
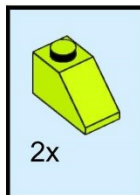

WEDO 2.0 «БАГГИ WIDOW»

22

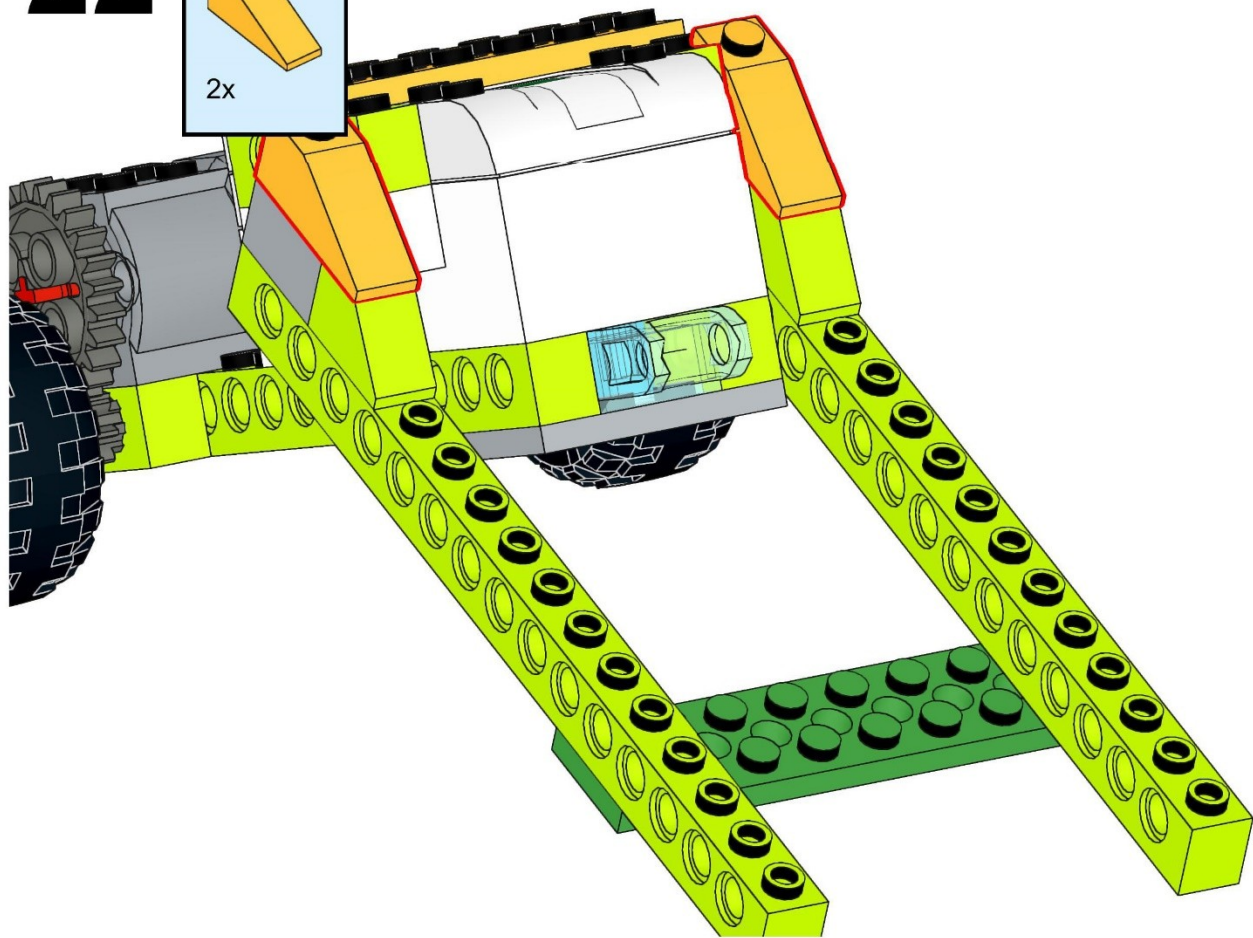
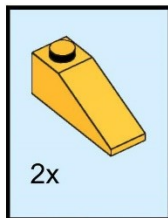

WEDO 2.0 «БАГГИ WIDOW»

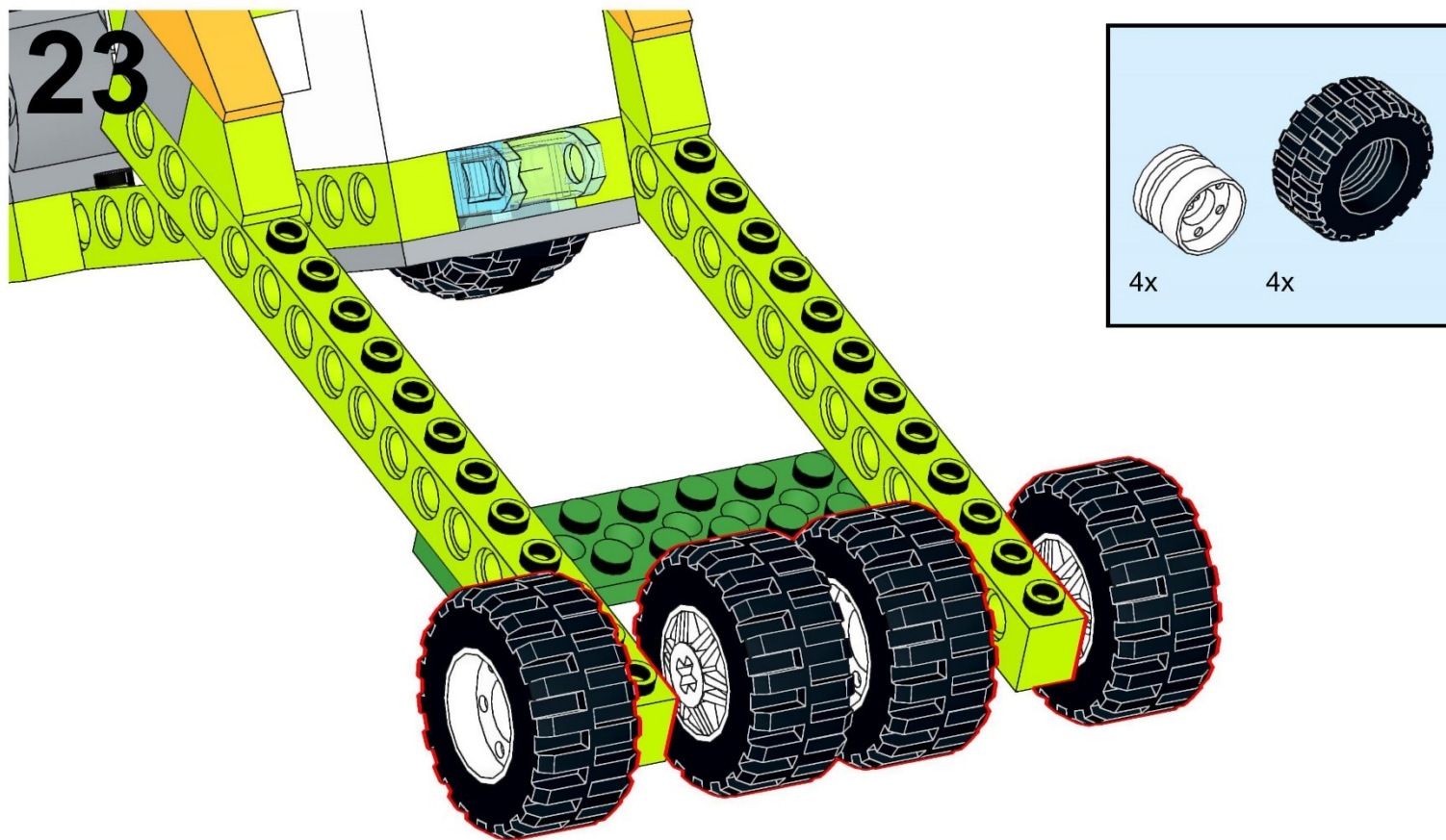

WEDO 2.0 «БАГГИ WIDOW»

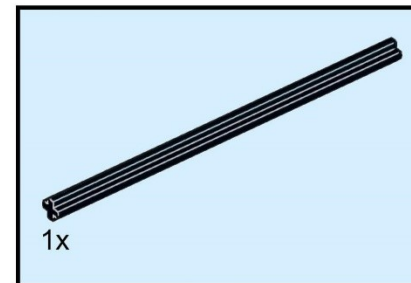
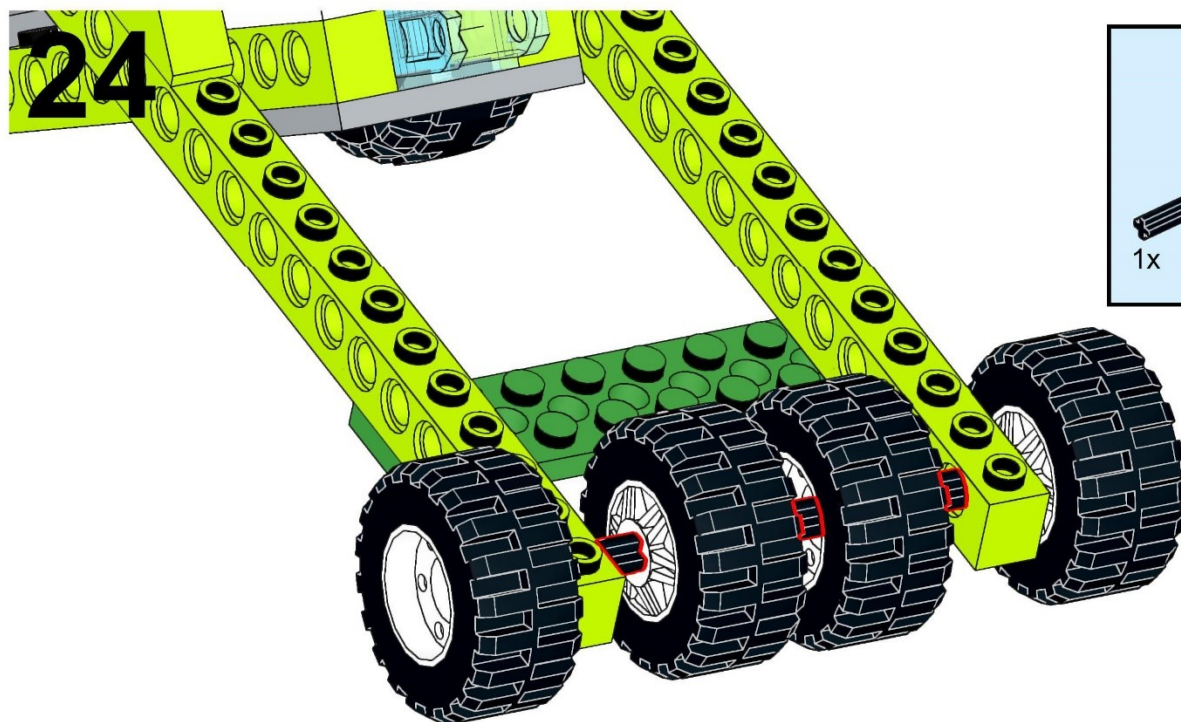

WEDO 2.0 «БАГГИ WIDOW»

25

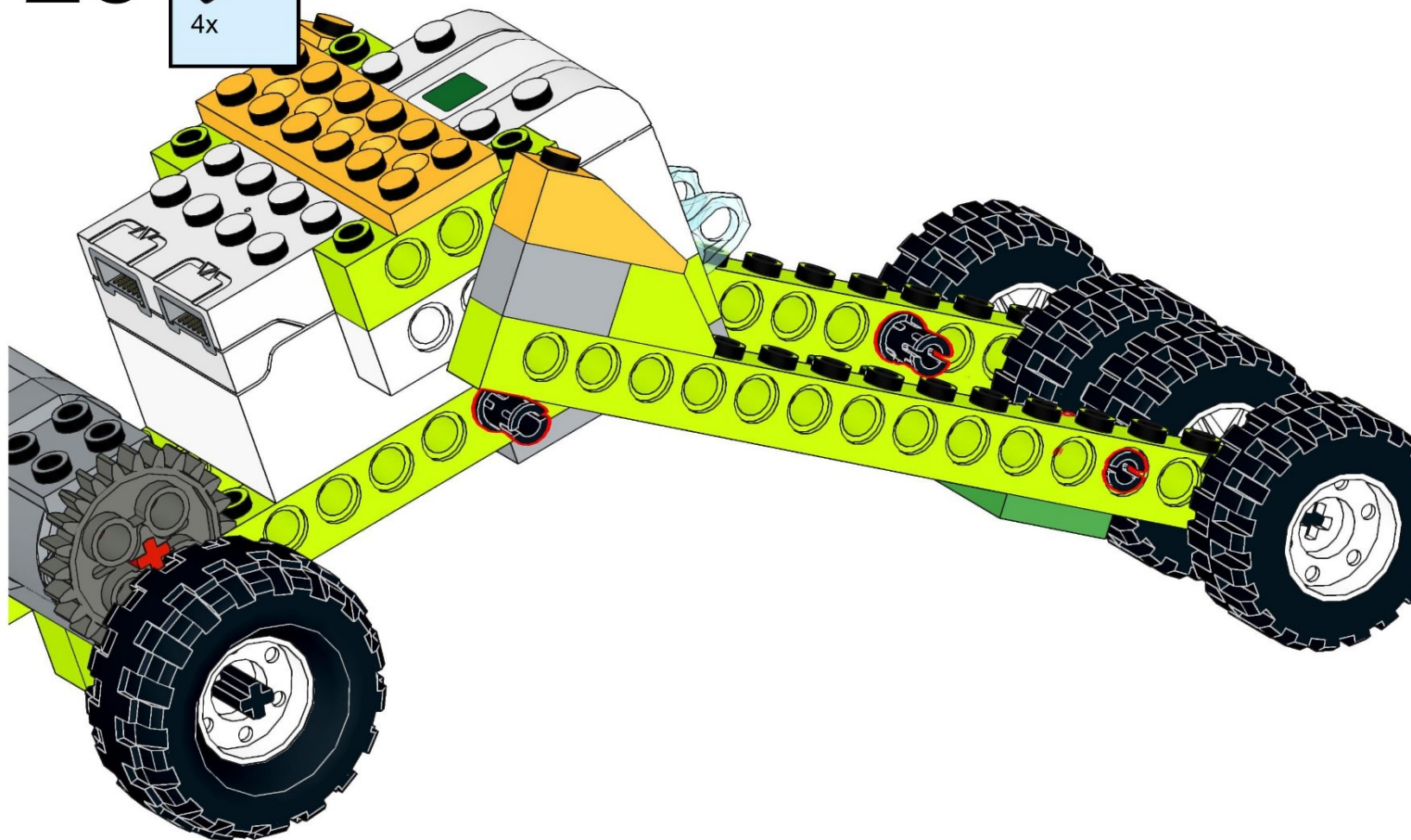

WEDO 2.0 «БАГГИ WIDOW»

26

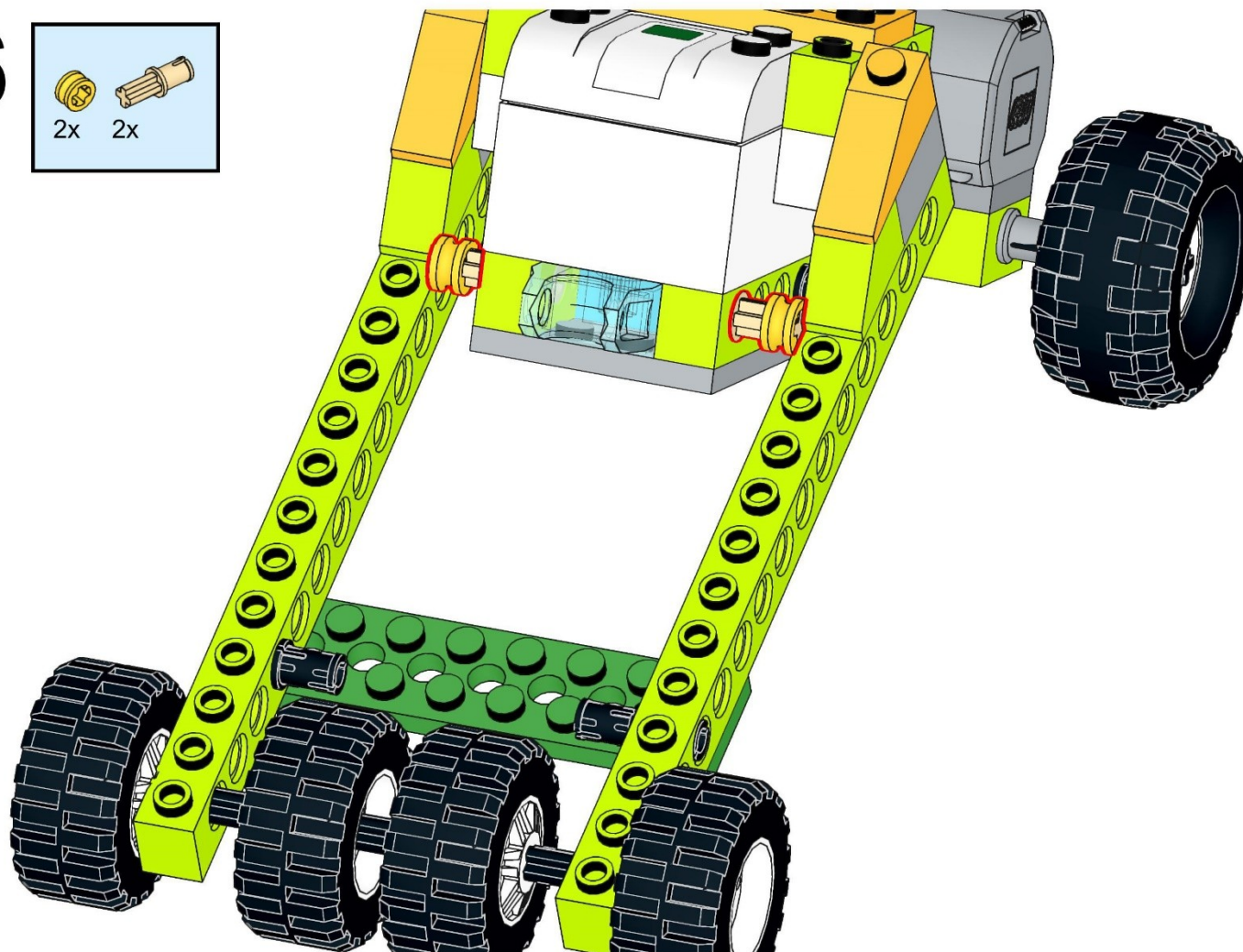
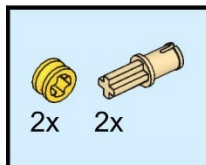

WEDO 2.0 «БАГГИ WIDOW»

27

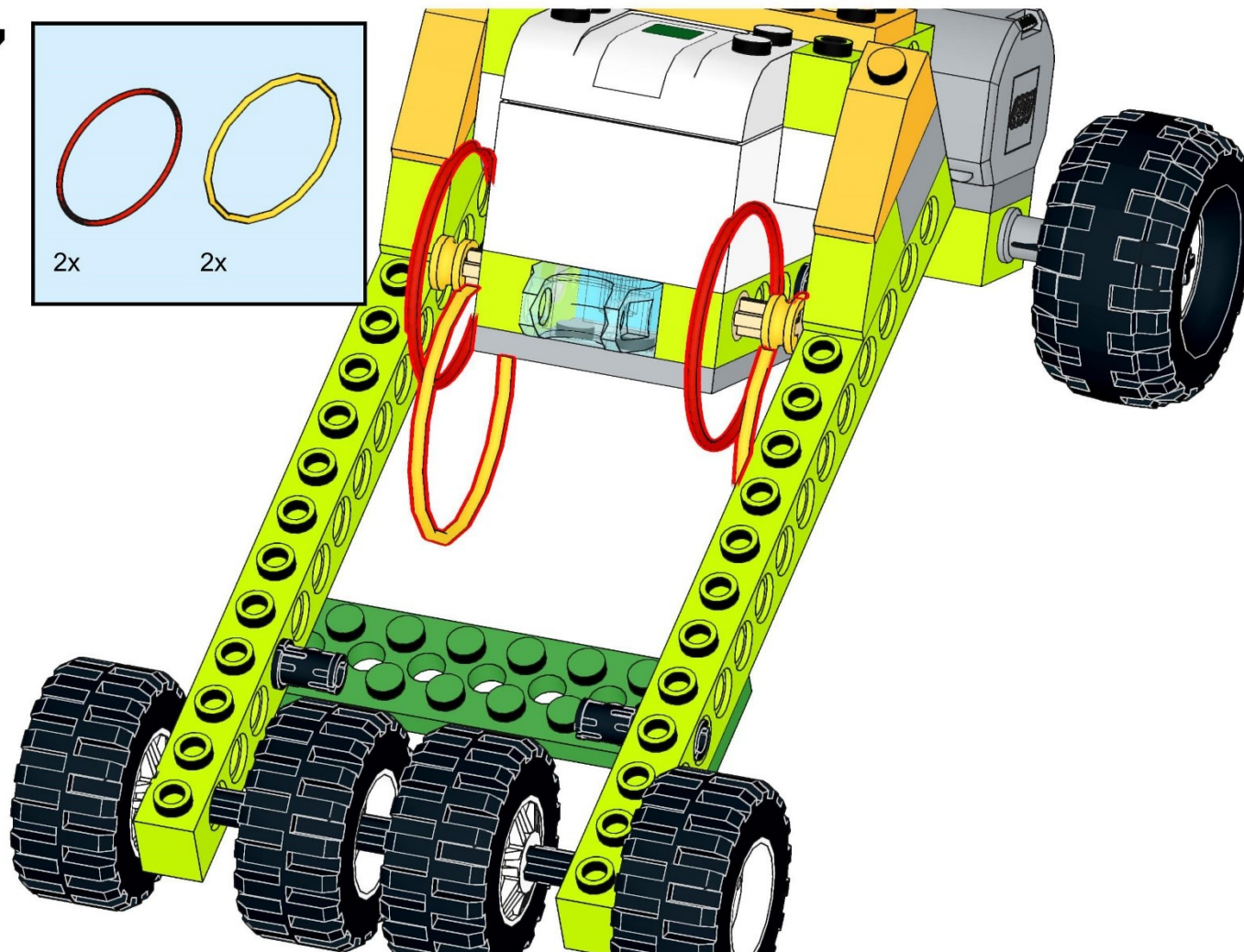
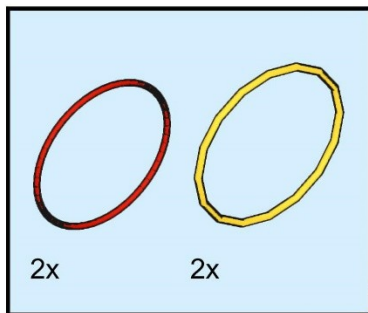

WEDO 2.0 «БАГГИ WIDOW»

28

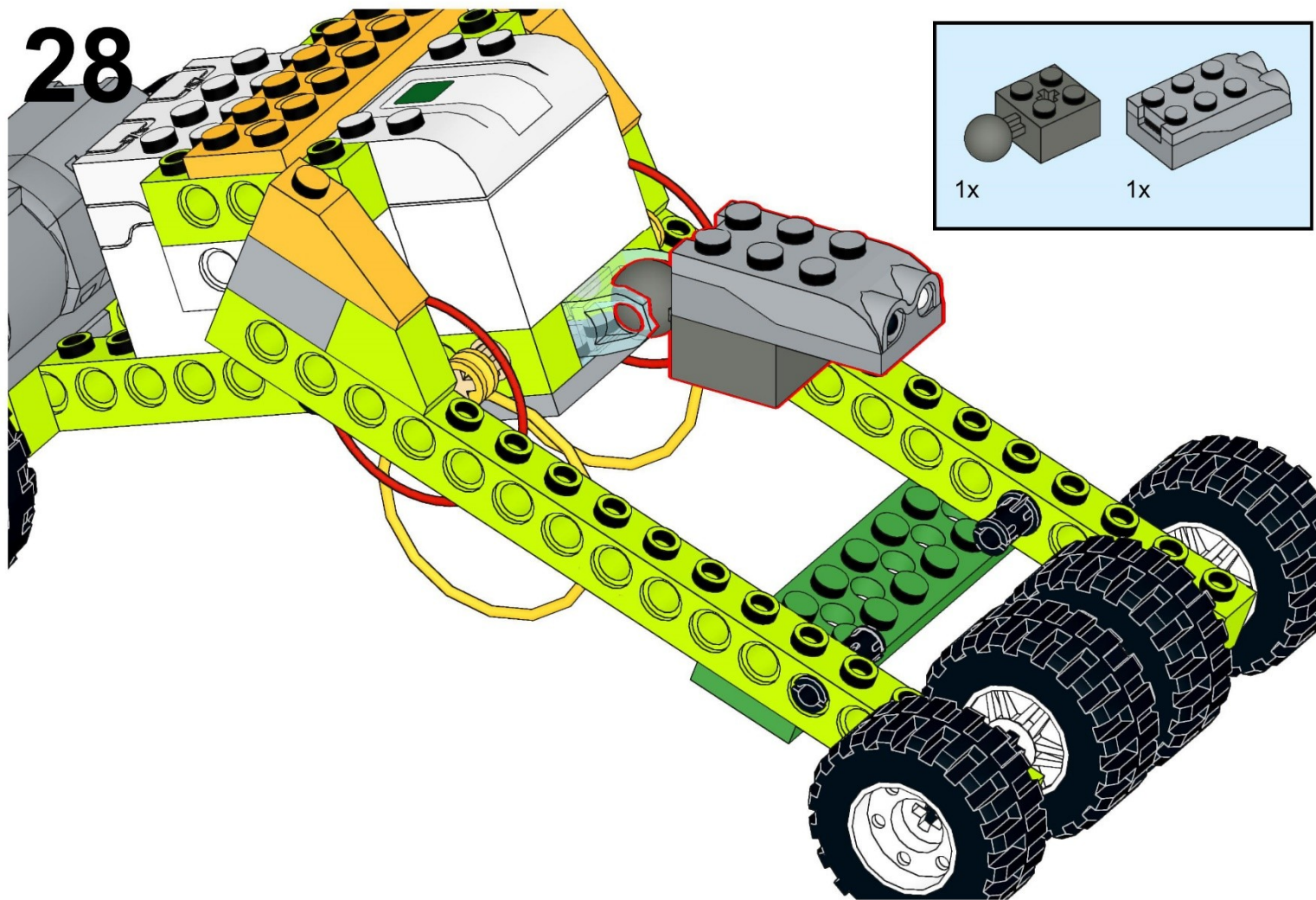

WEDO 2.0 «БАГГИ WIDOW»

УПРАВЛЯЮЩАЯ ПРОГРАММА:



WEDO 2.0 «БАГГИ WIDOW»

ЗАДАНИЯ:

1. Вставьте в управляющую программу блок звука и запишите звук мотора багги. Найдите звук в Интернете.
2. Придумайте свою независимую подвеску для задней оси багги.

WEDO 2.0 «КРОКОДИЛ»

Спасибо
за работу!

<https://monitorbank.ru>