

# 1

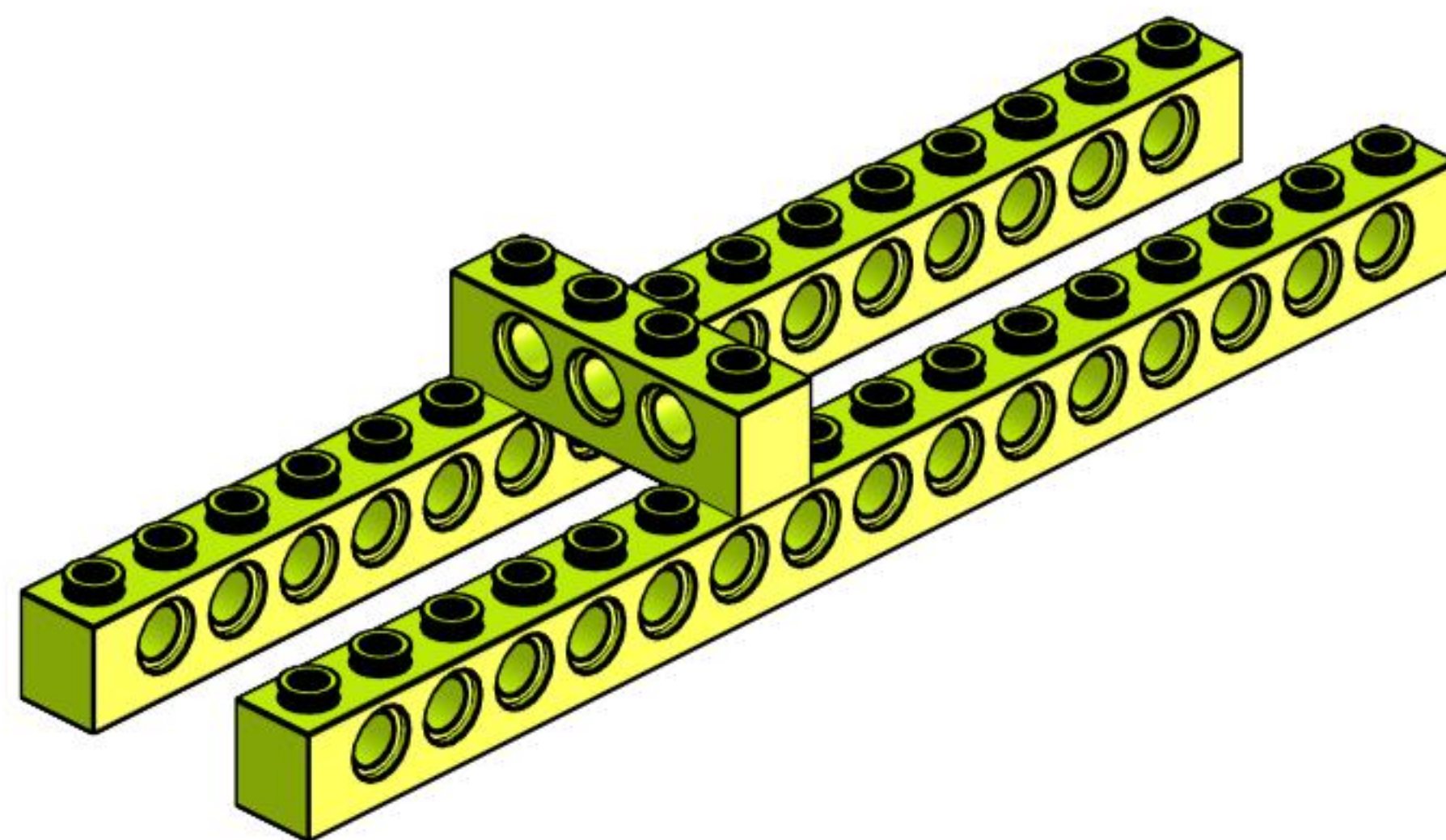

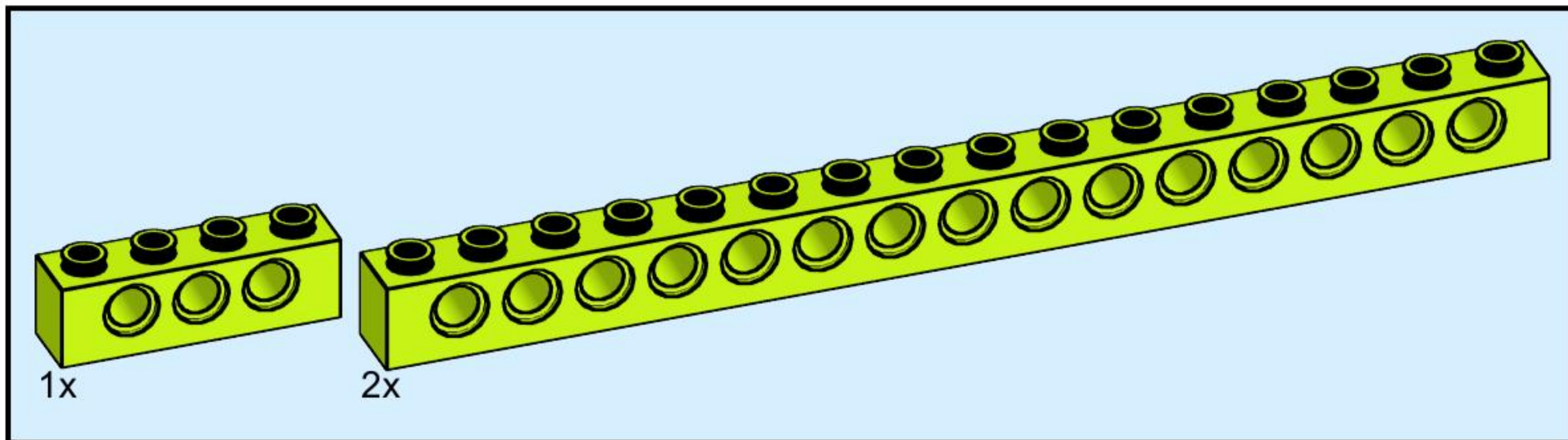

2

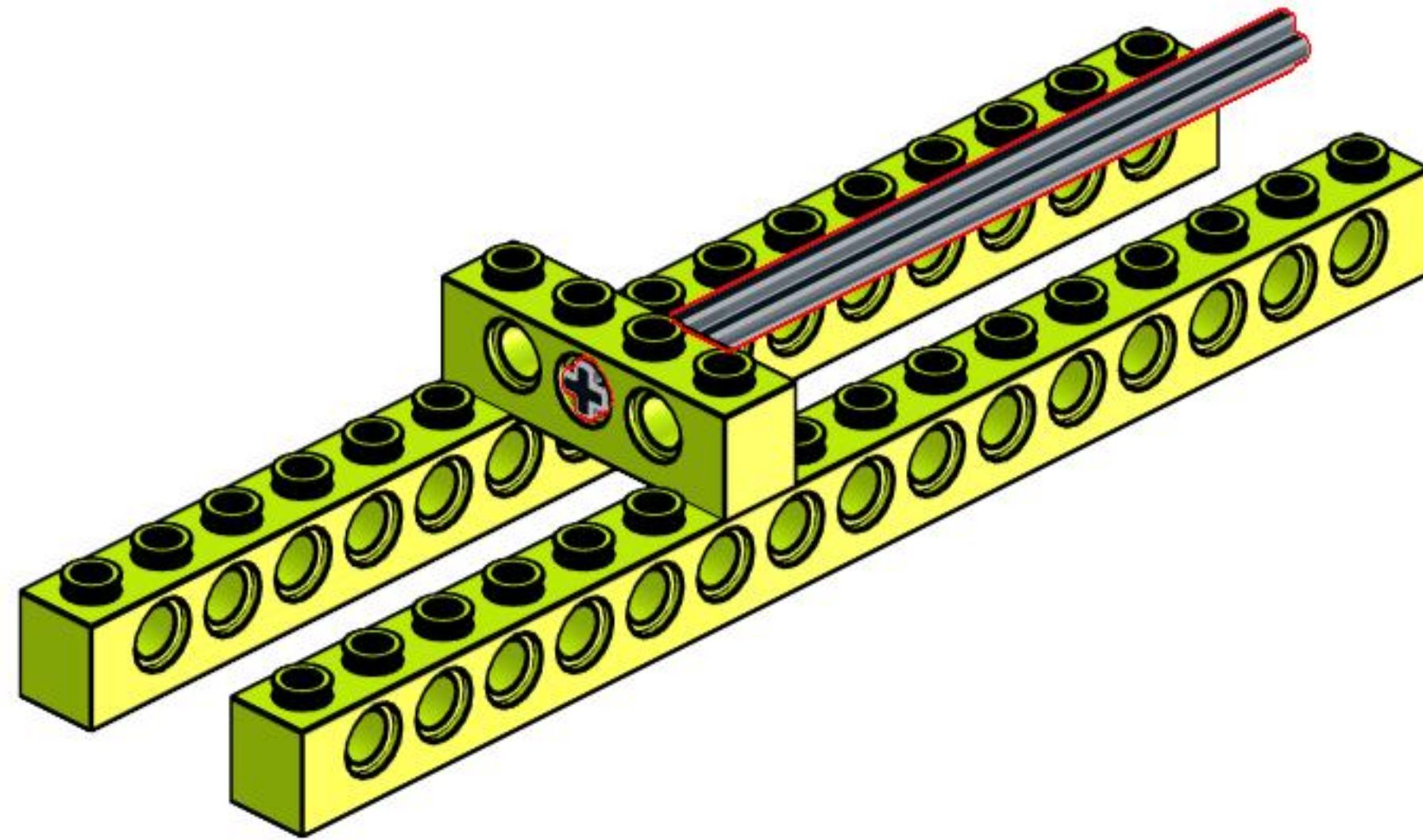
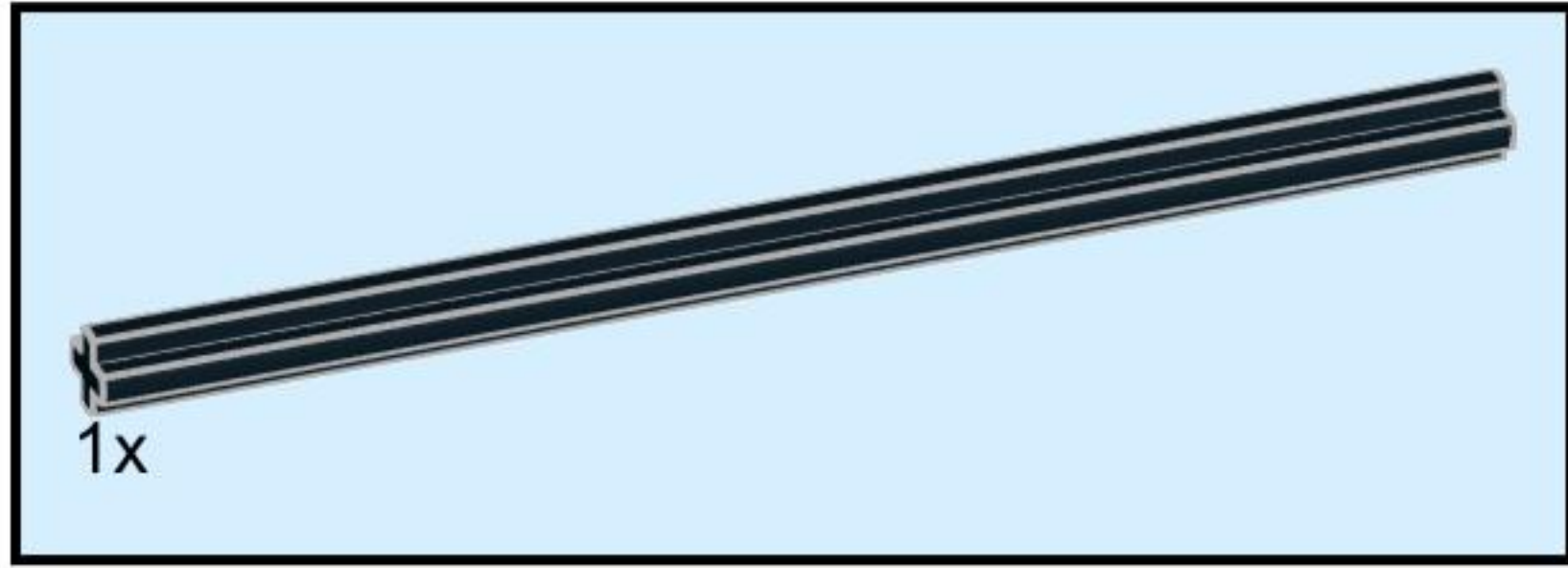

3

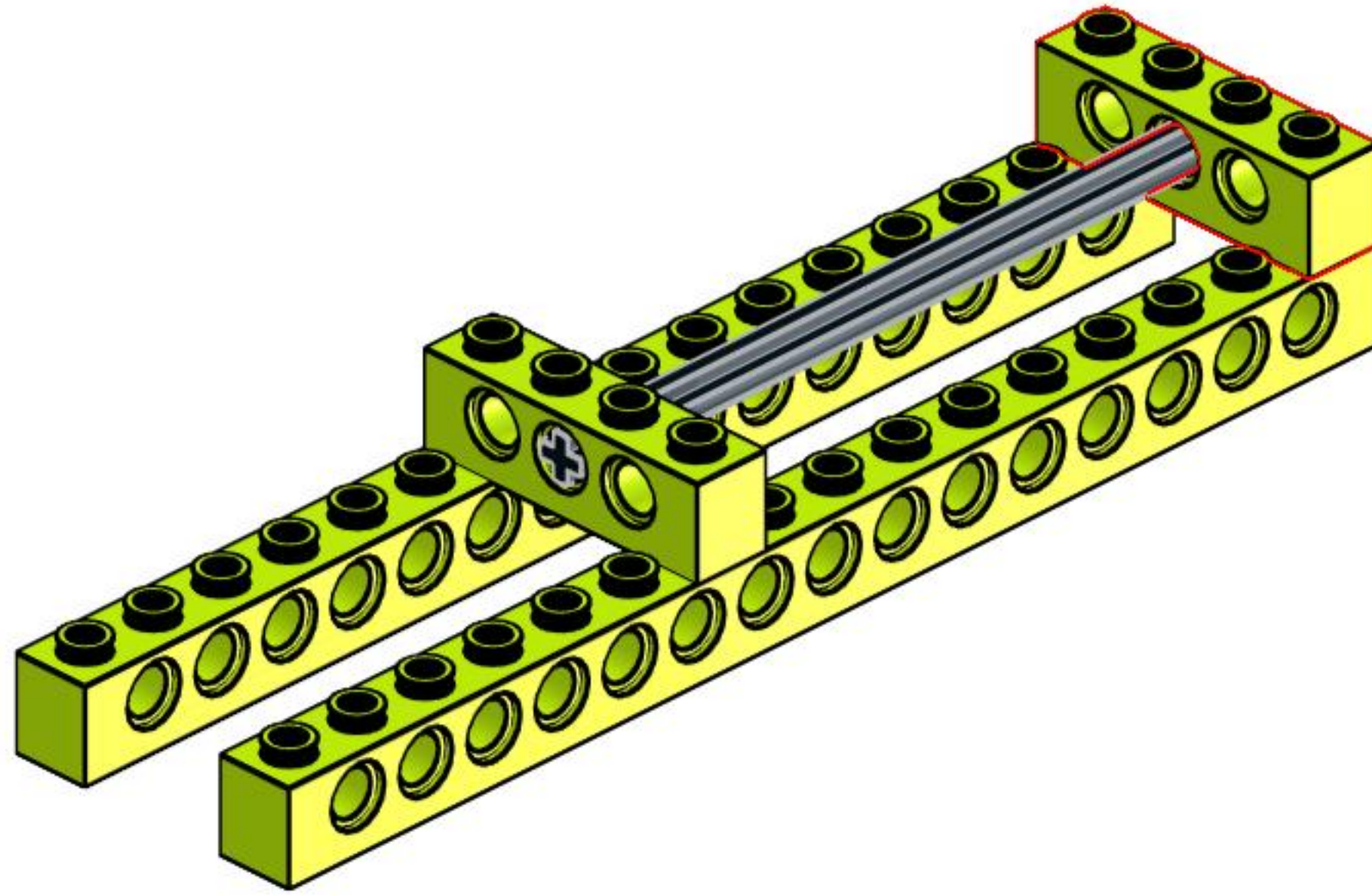
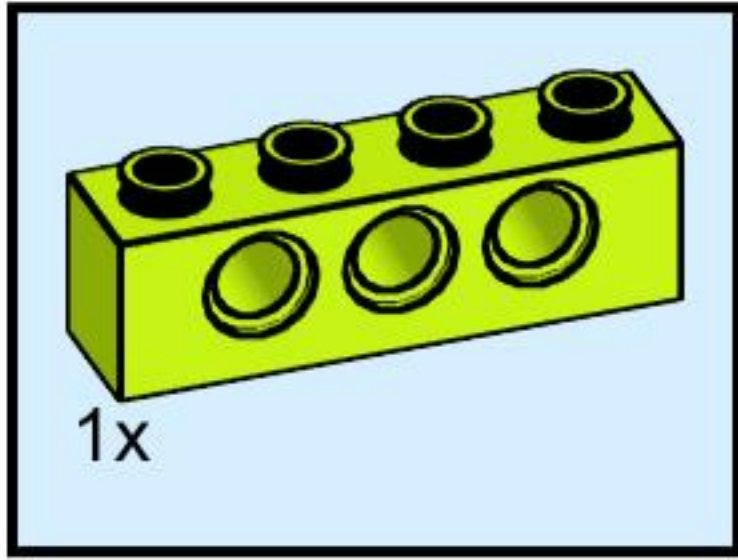



4

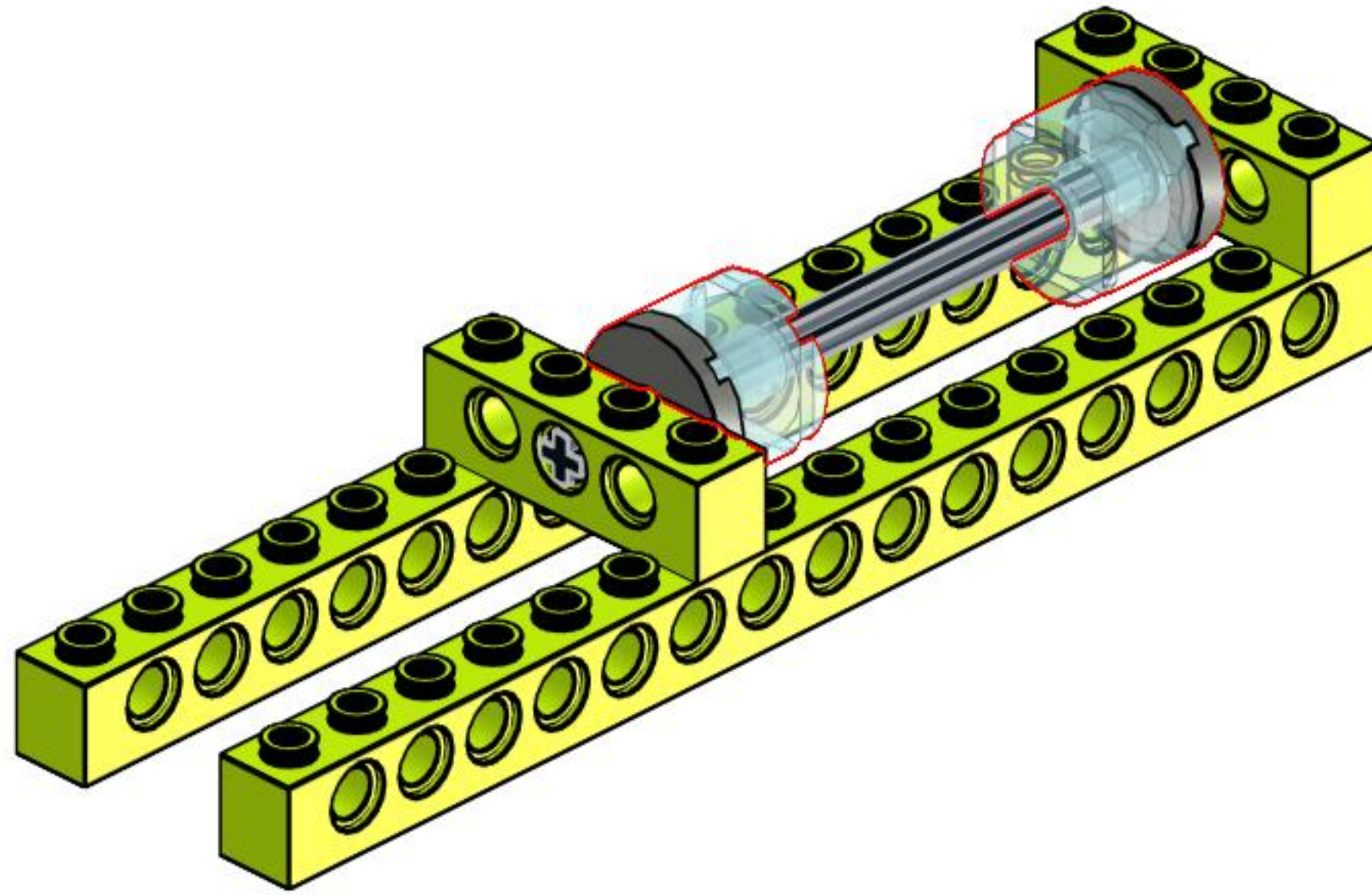
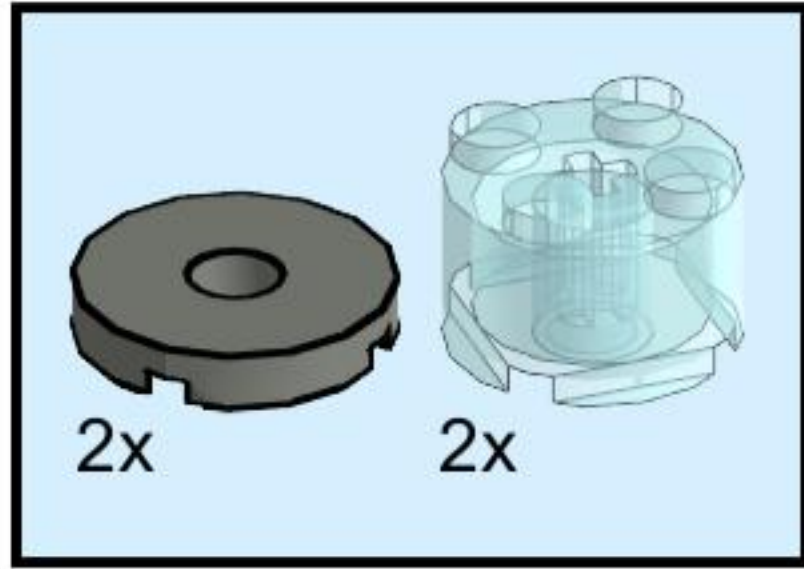

5

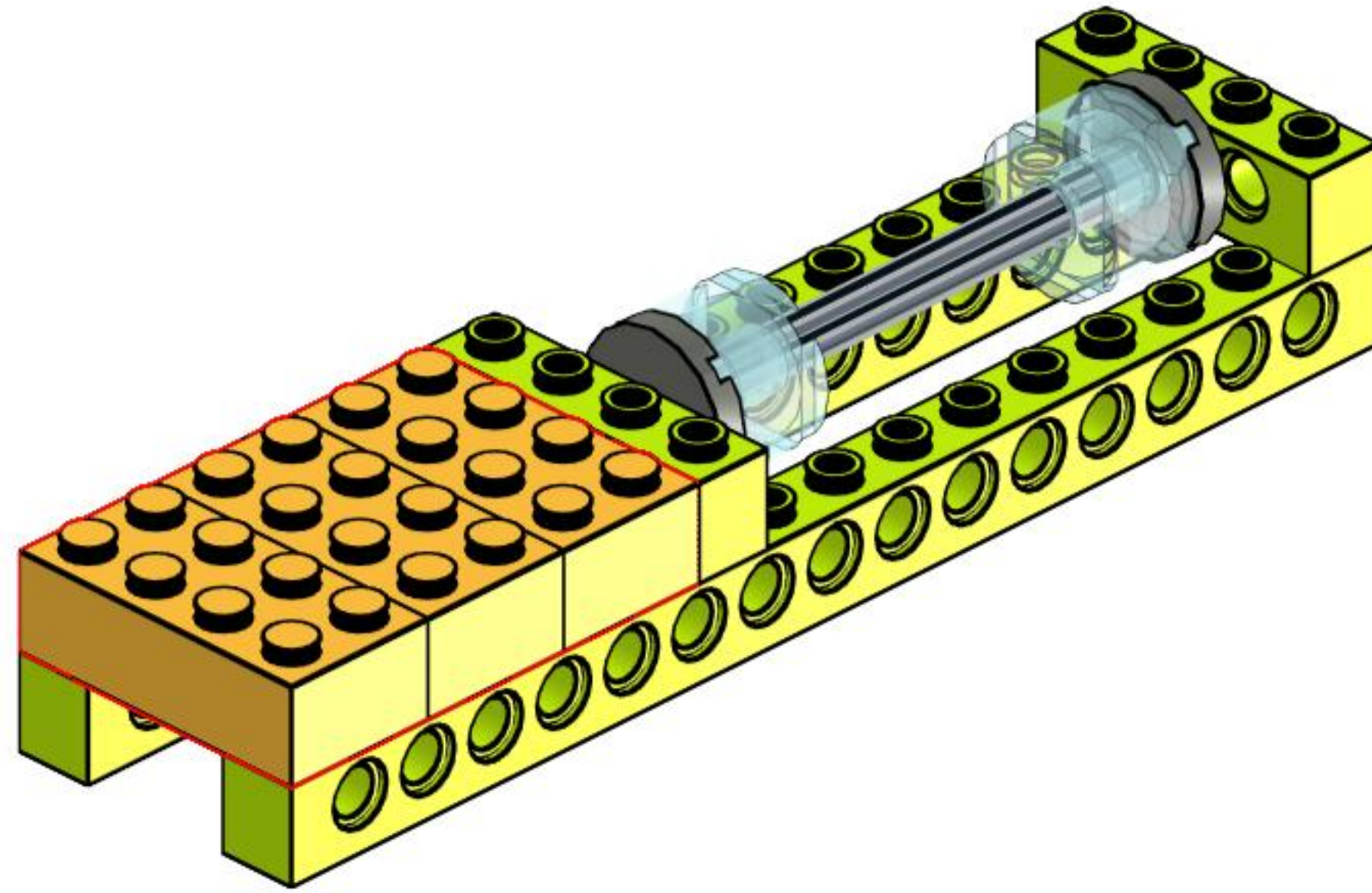
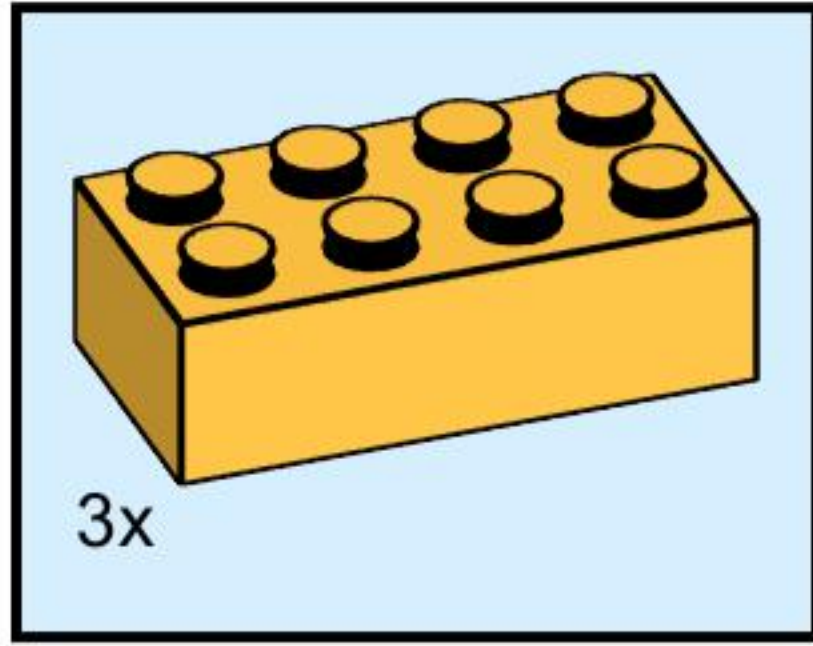



6

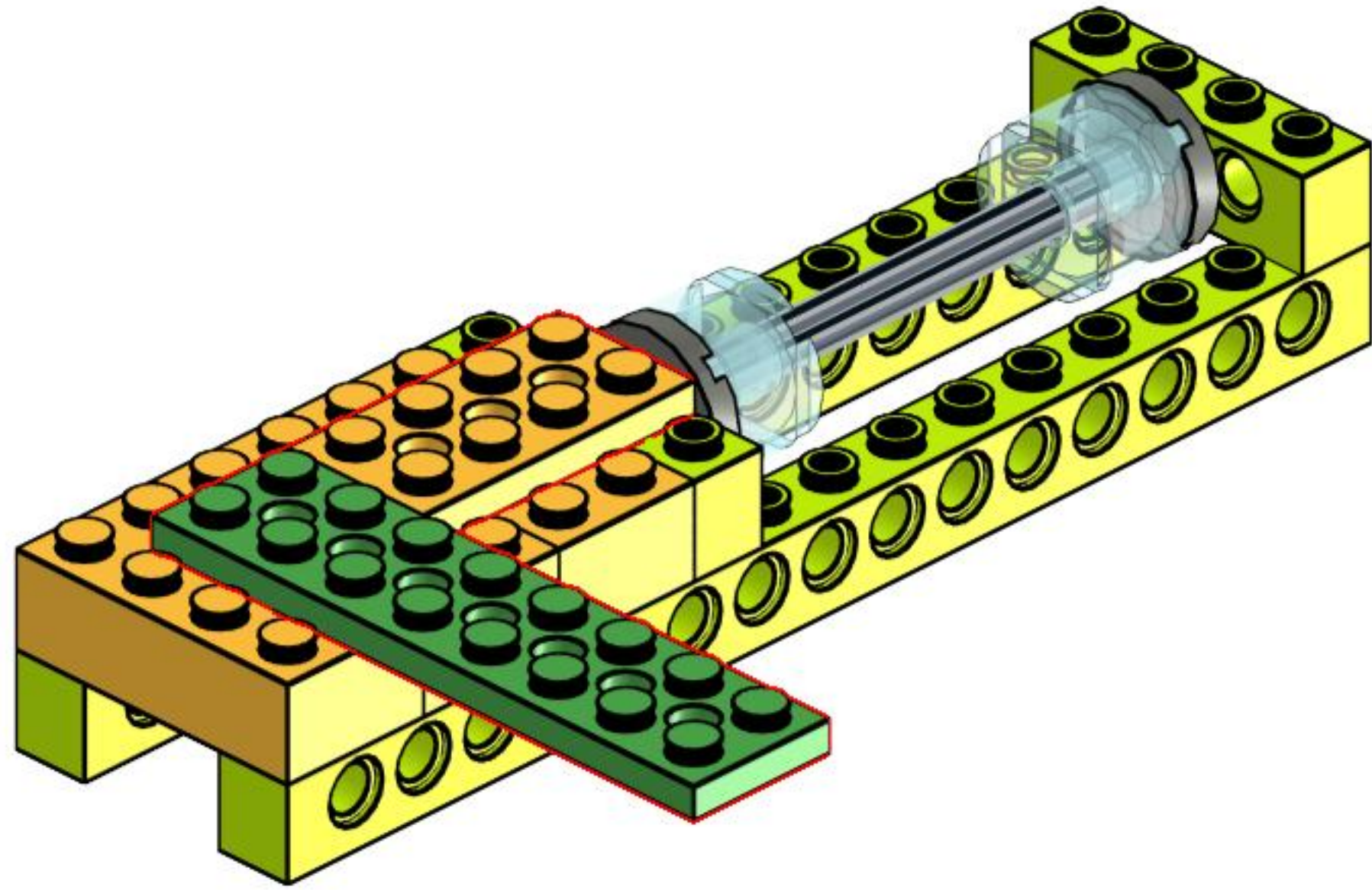
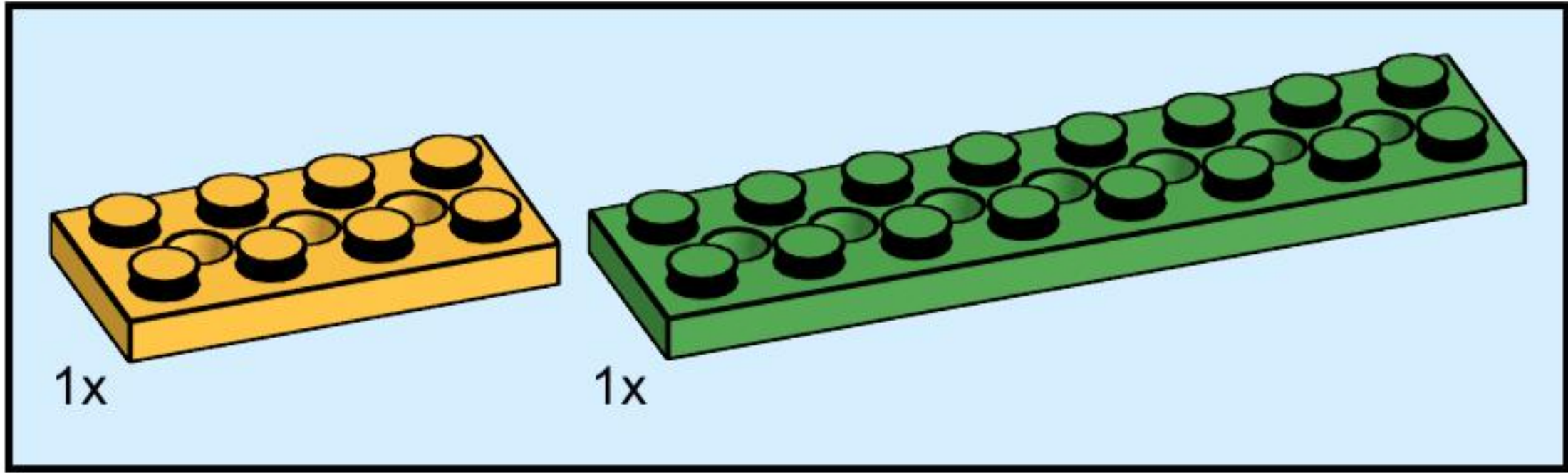



7

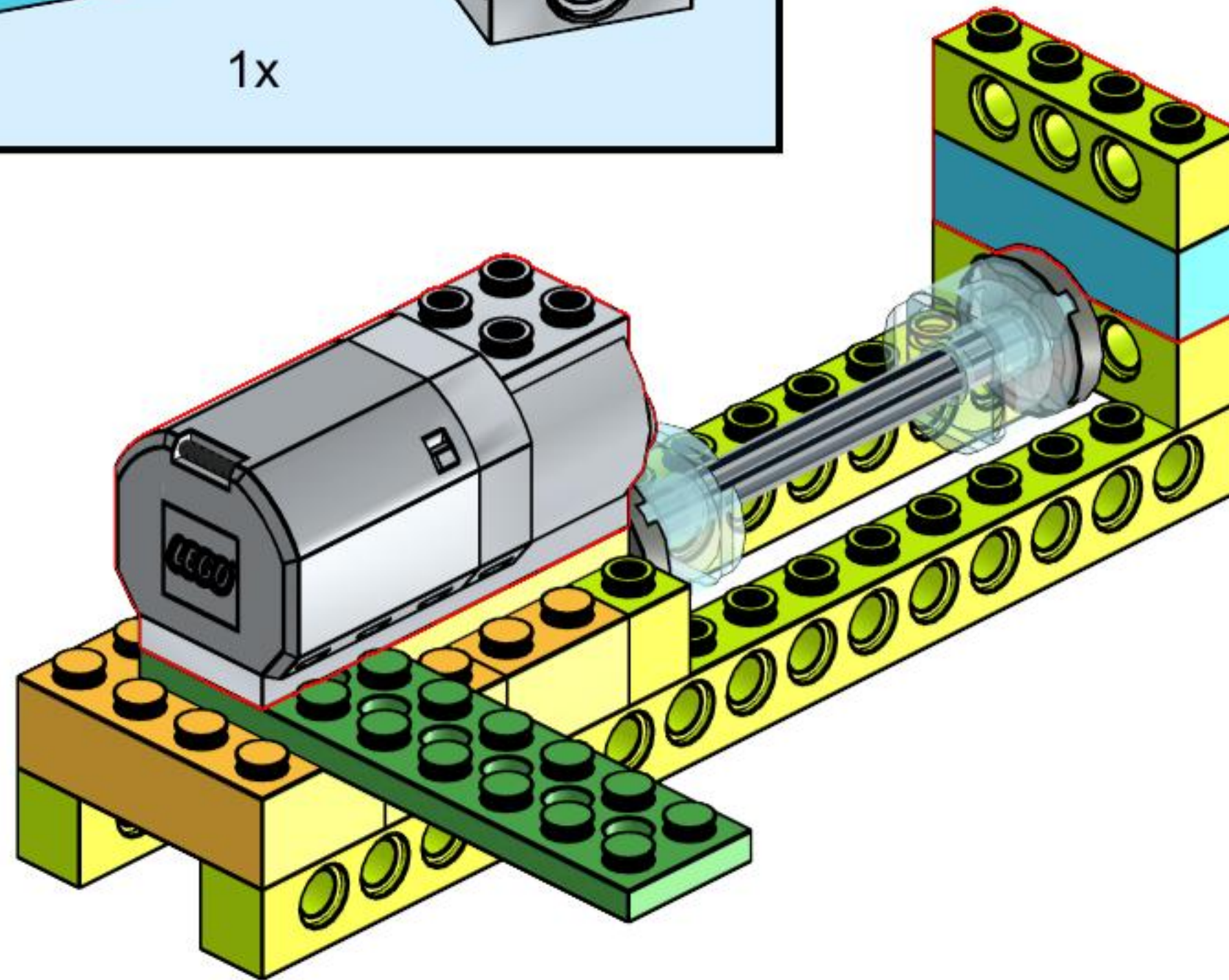
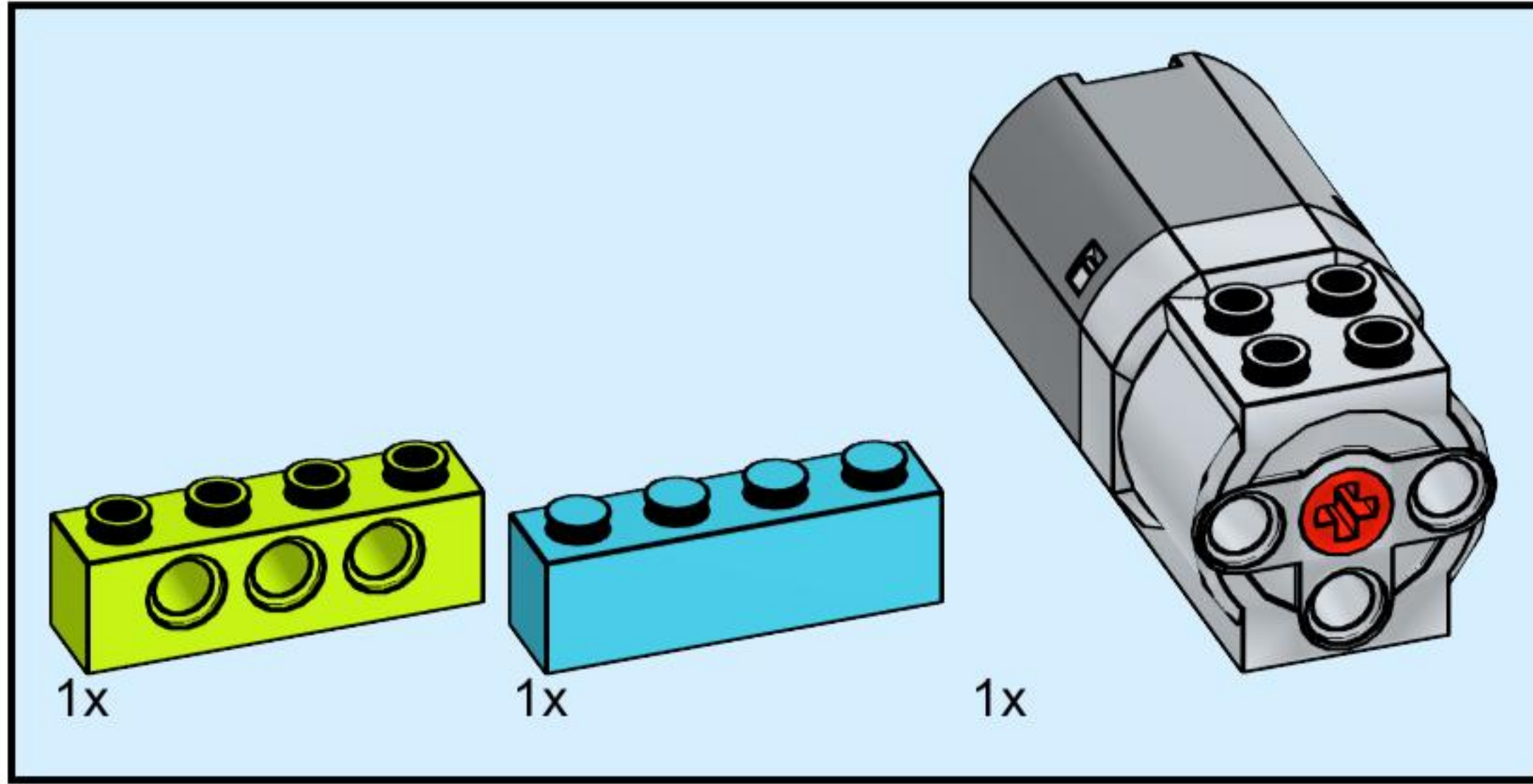



8

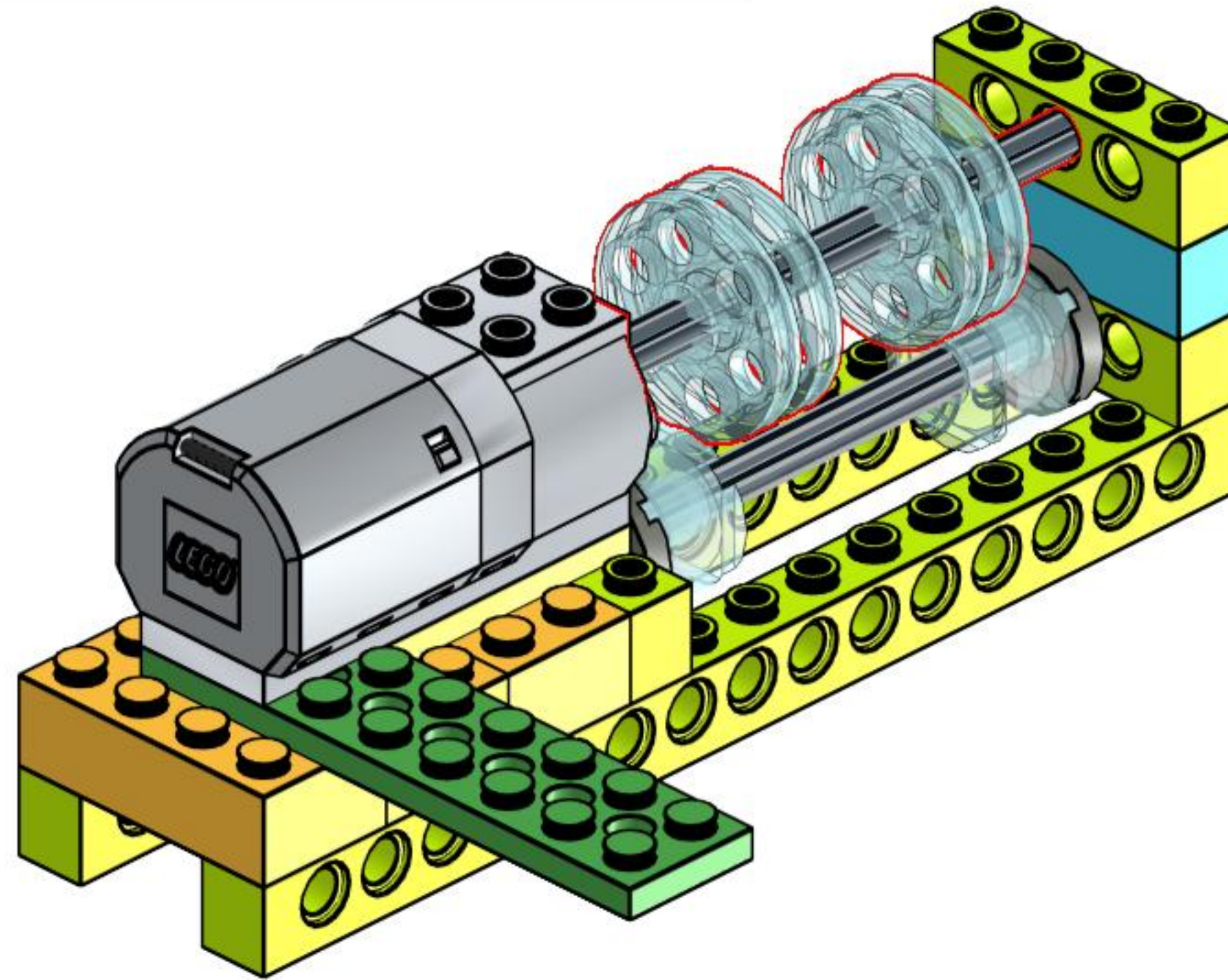
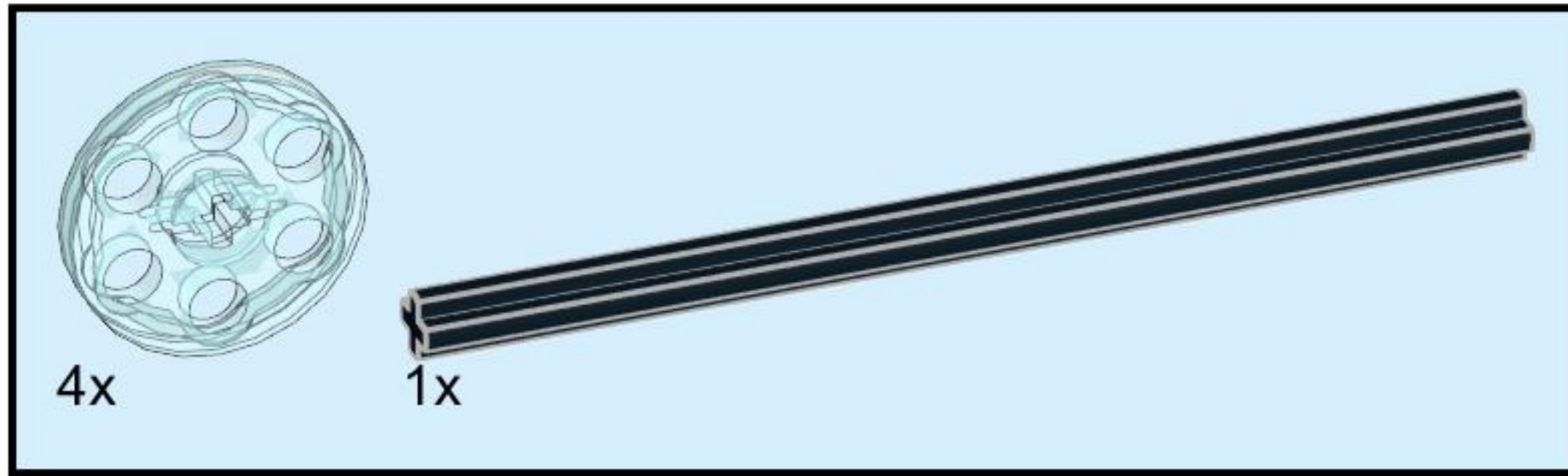



9

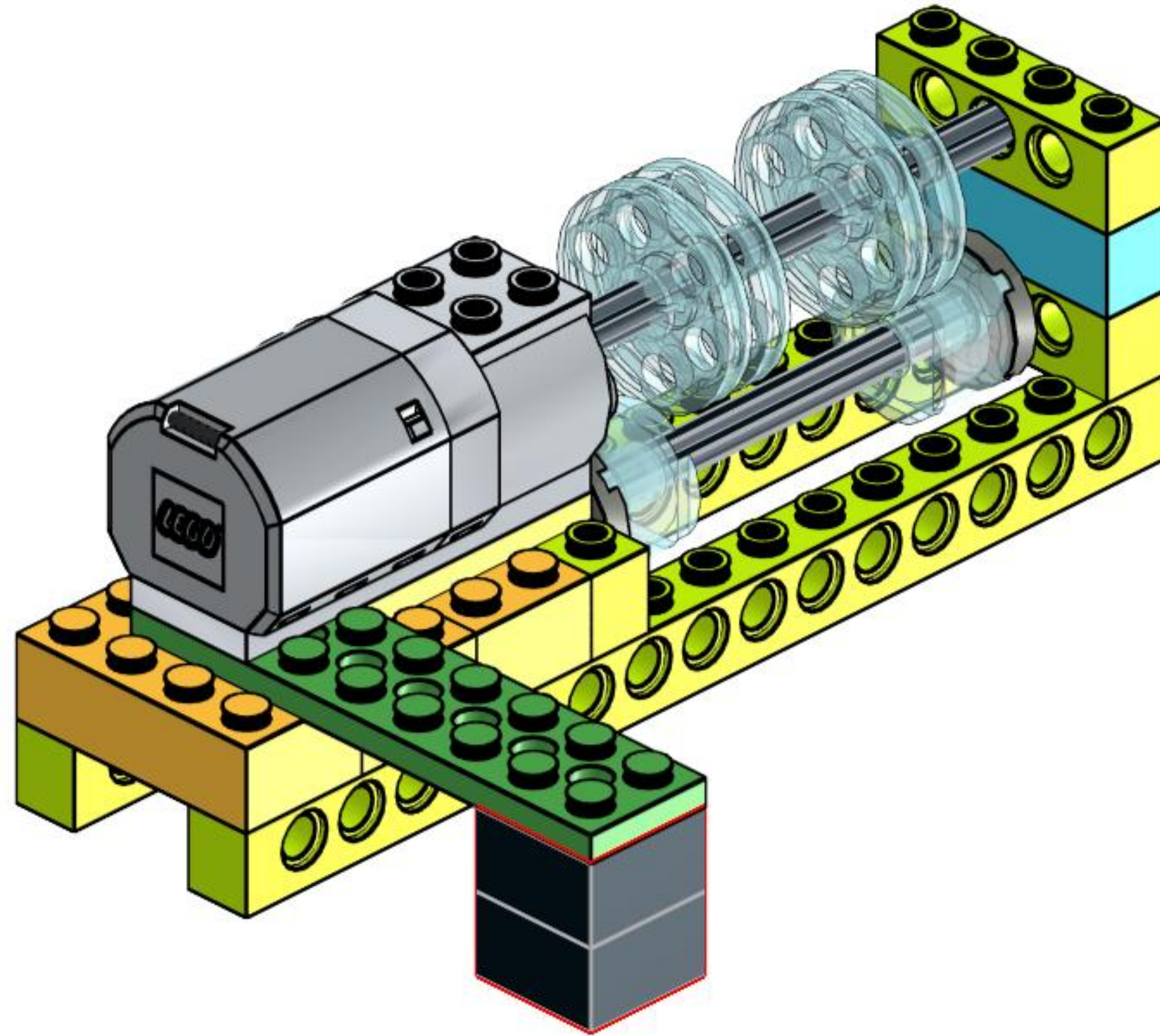
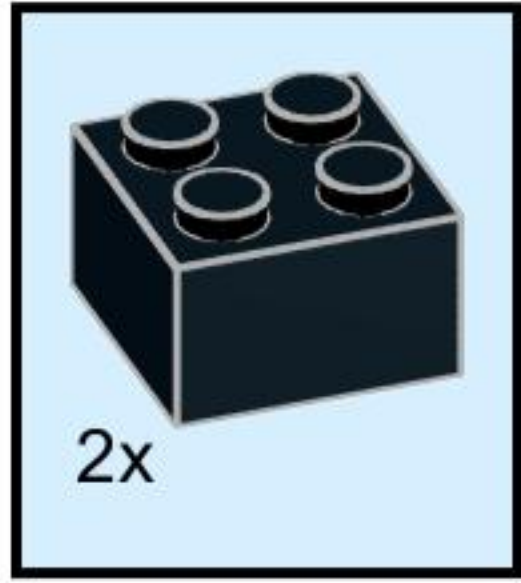



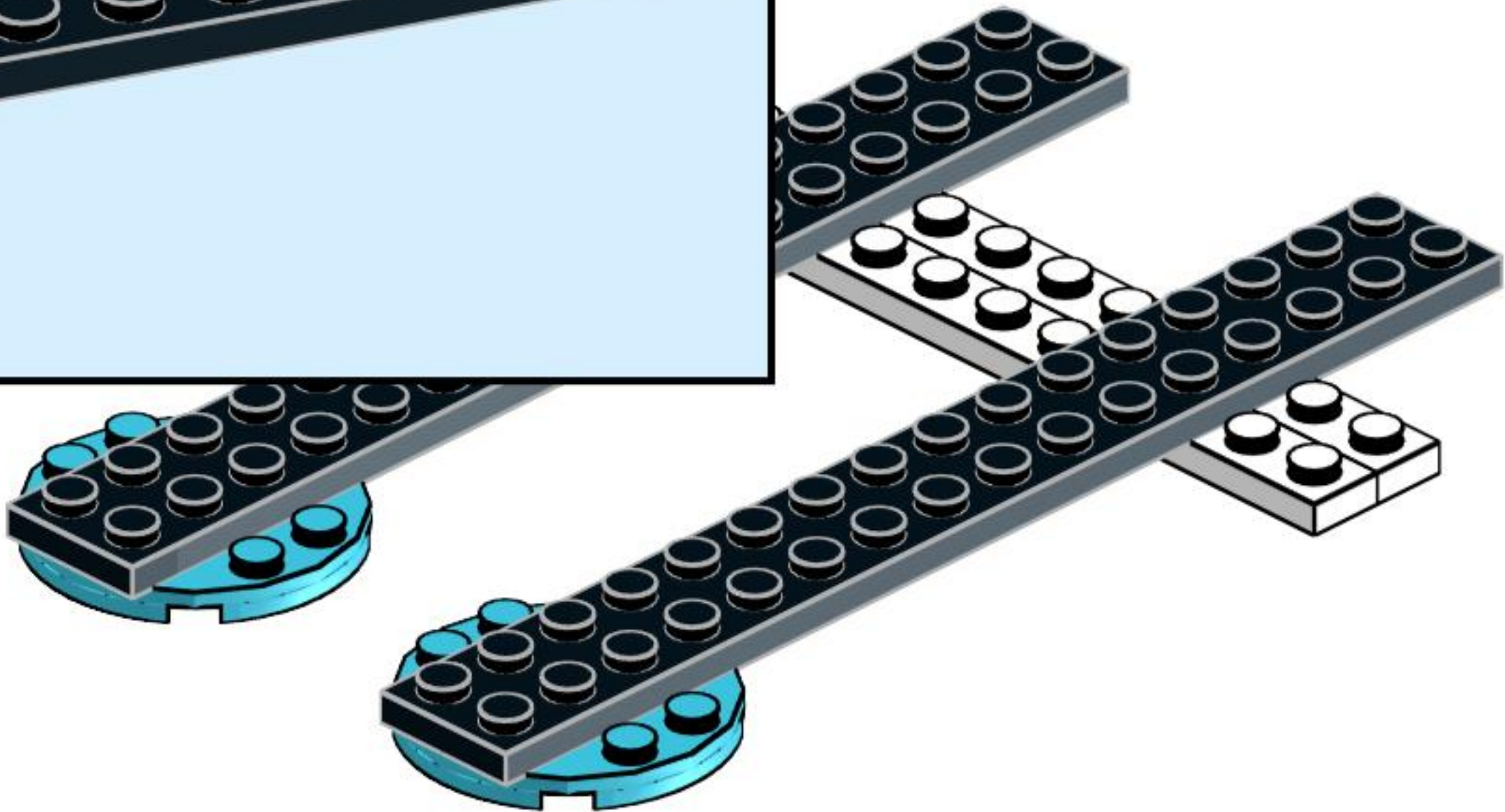
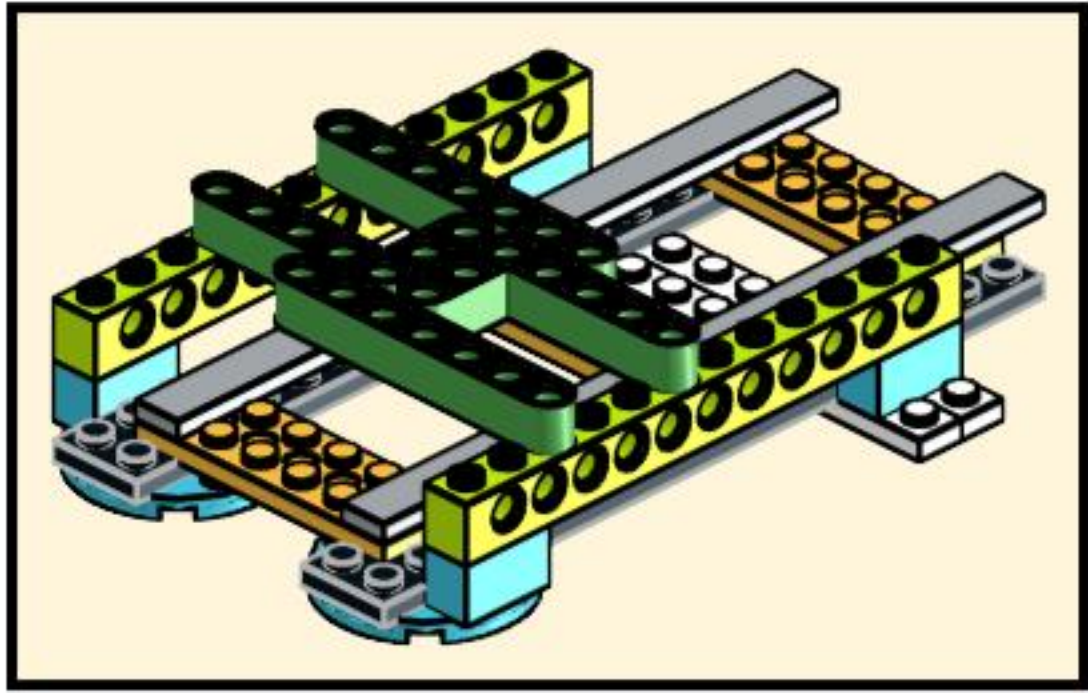
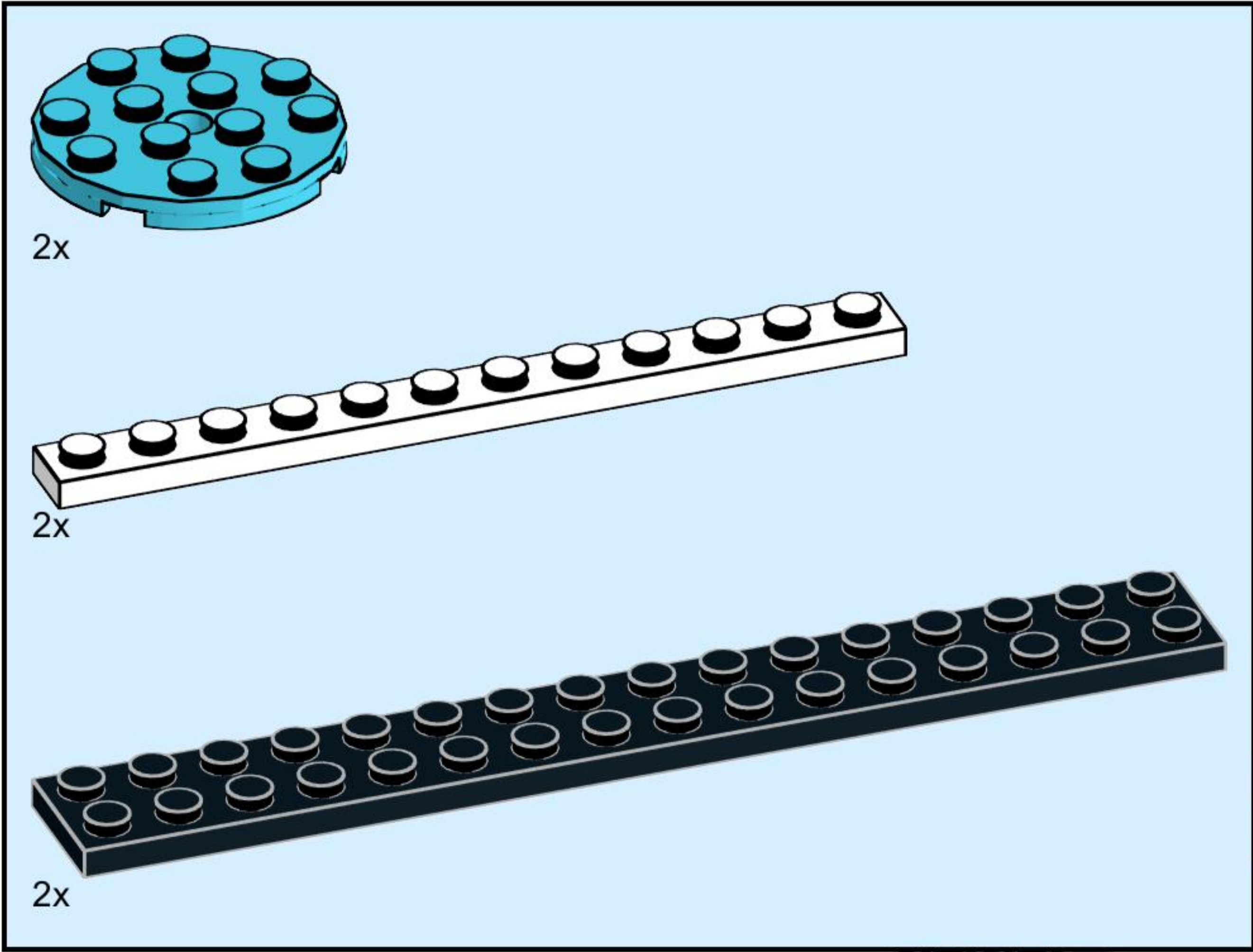

10



11

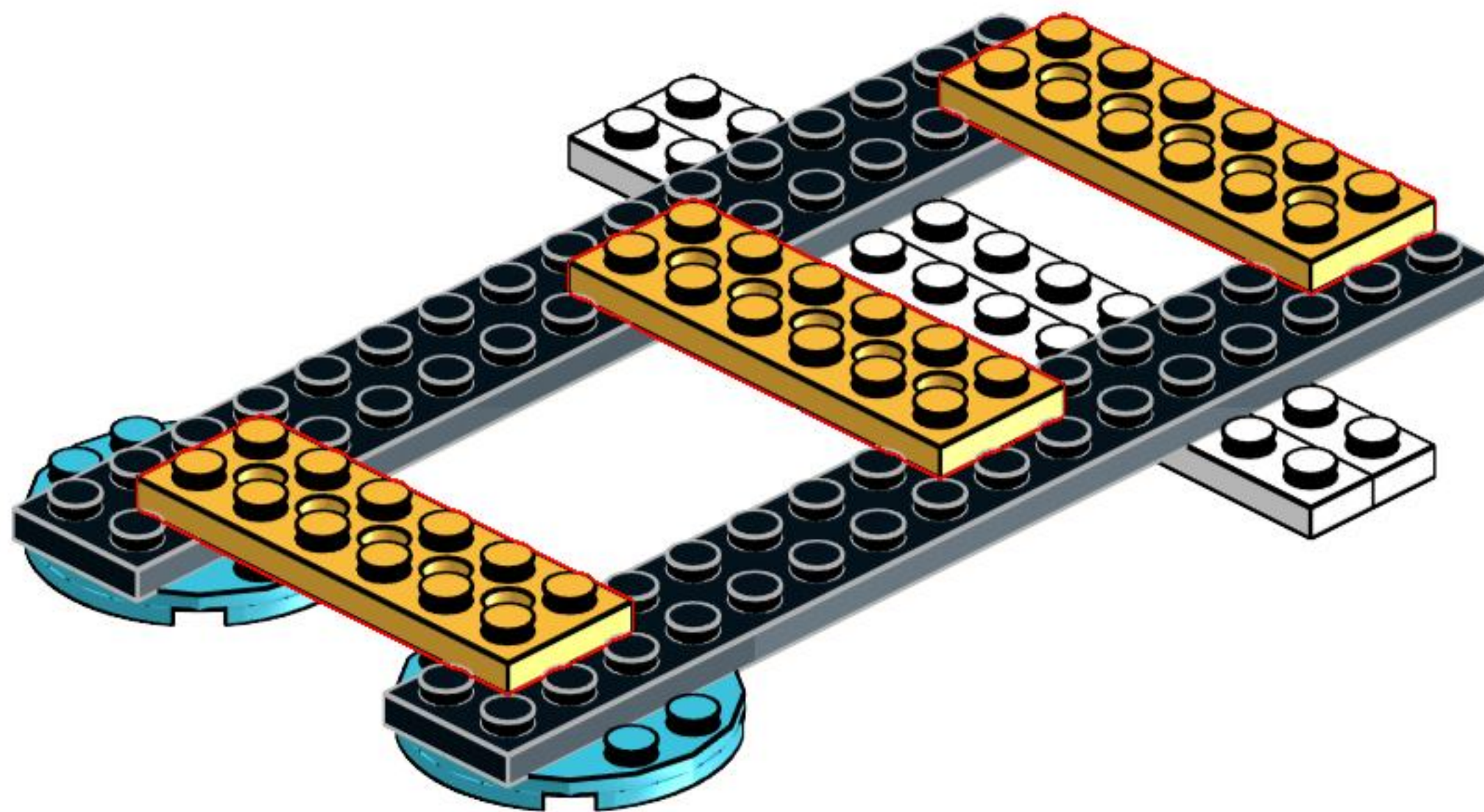
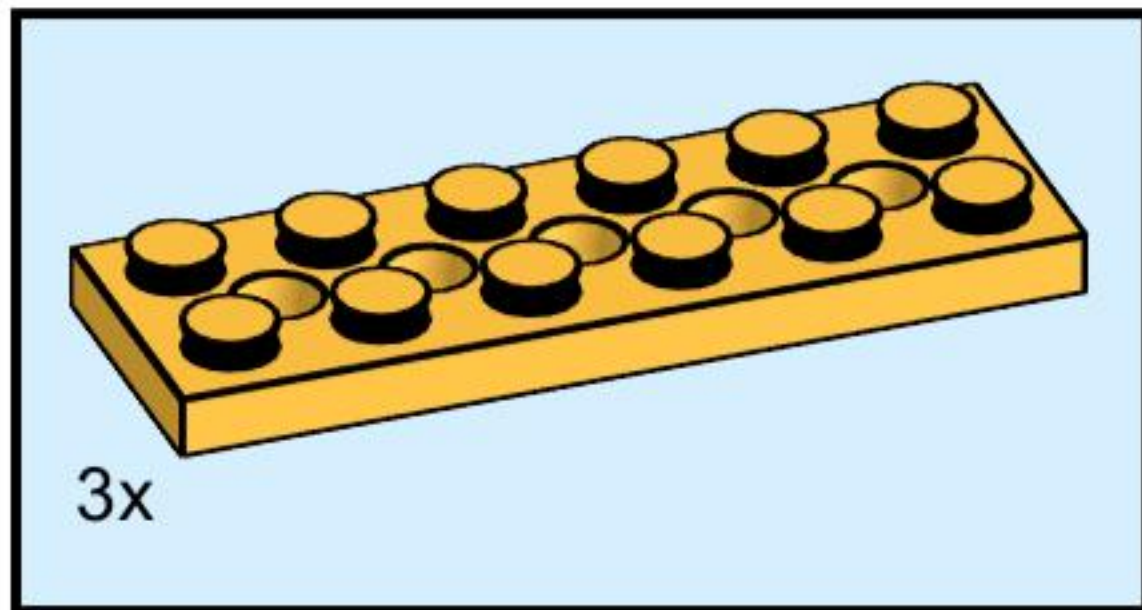



# 12

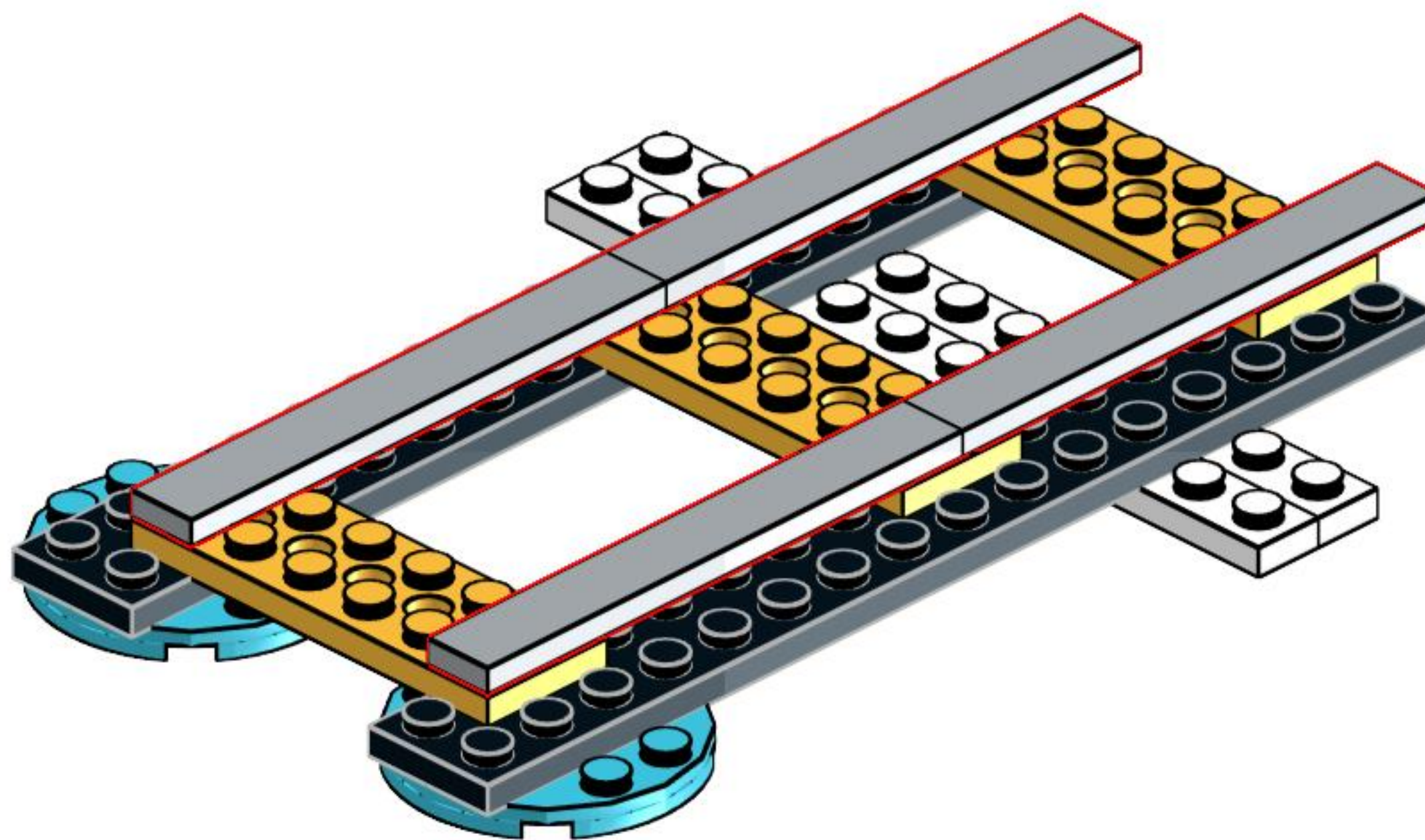
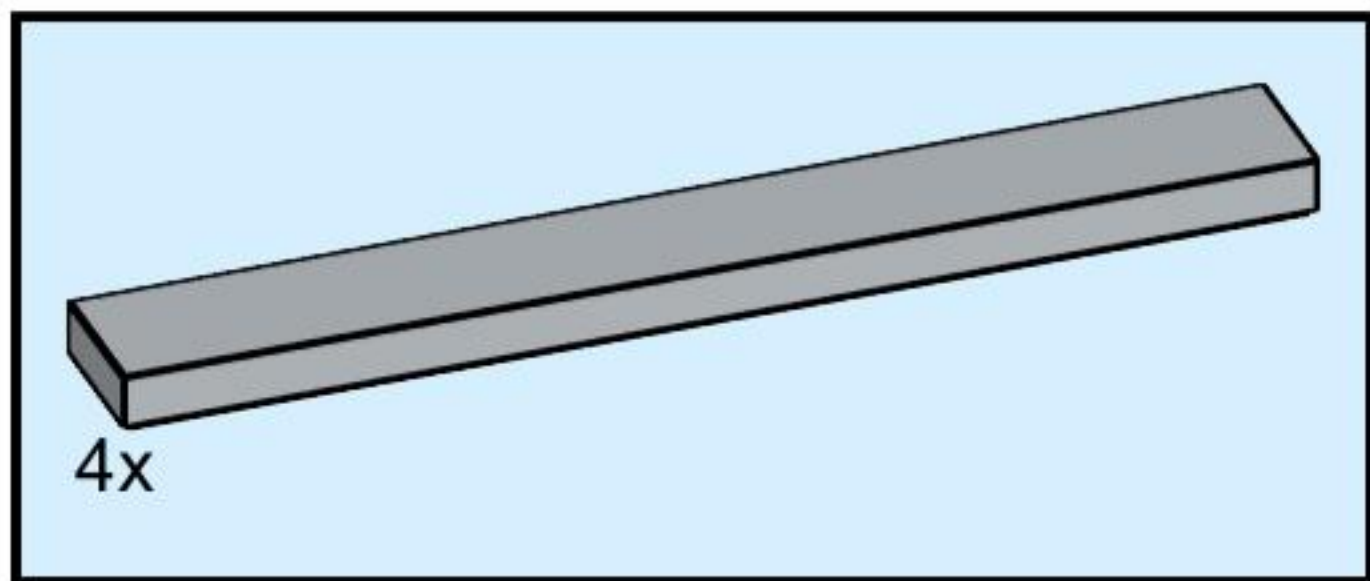



# 13

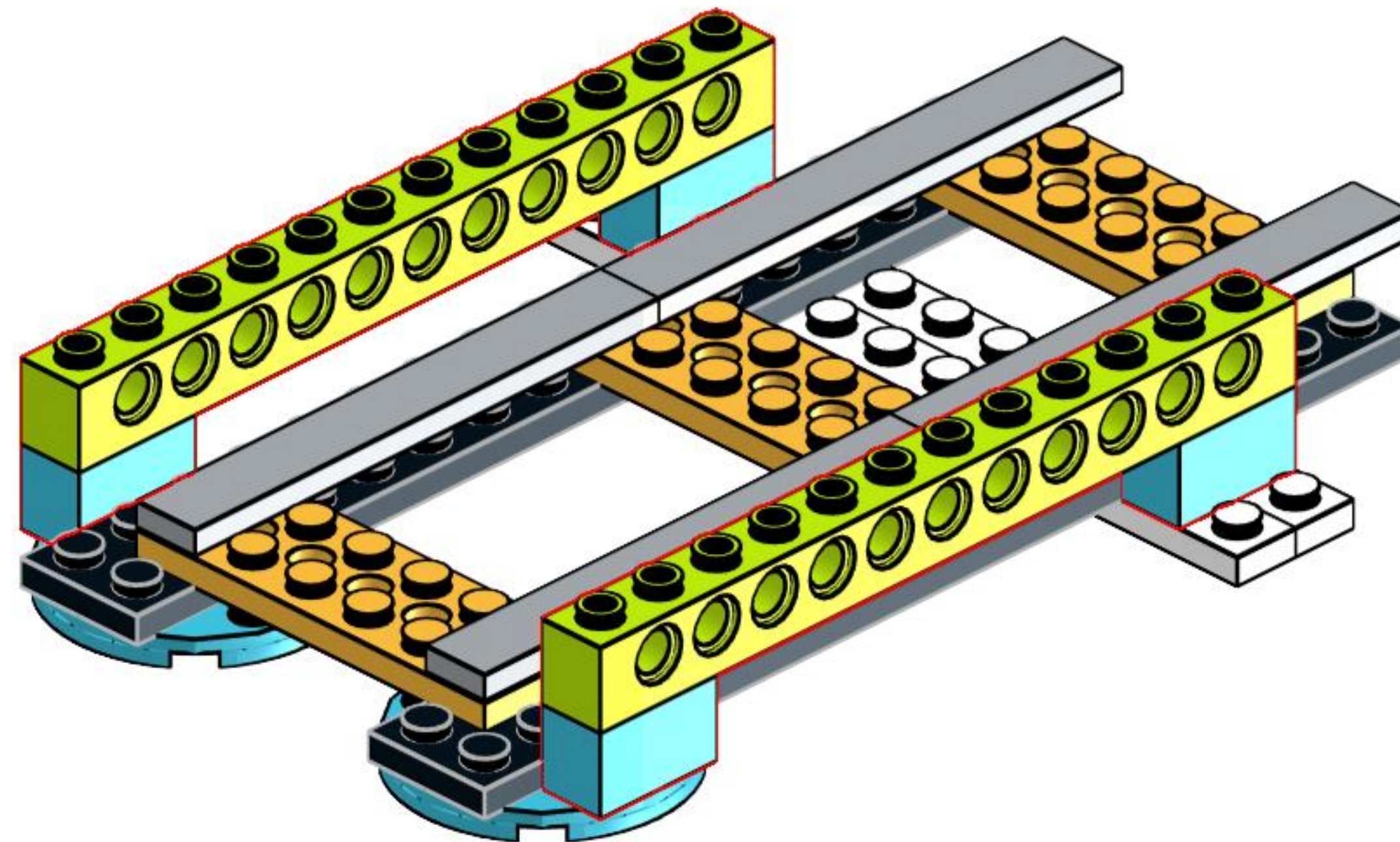
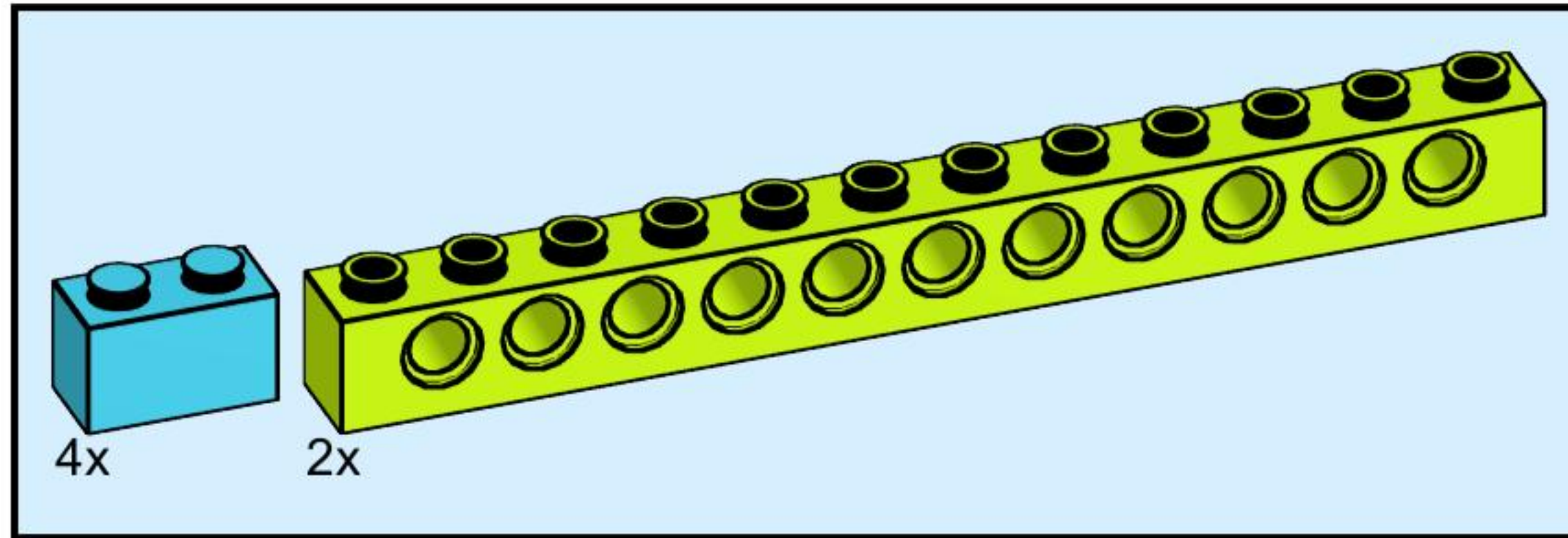



# 14

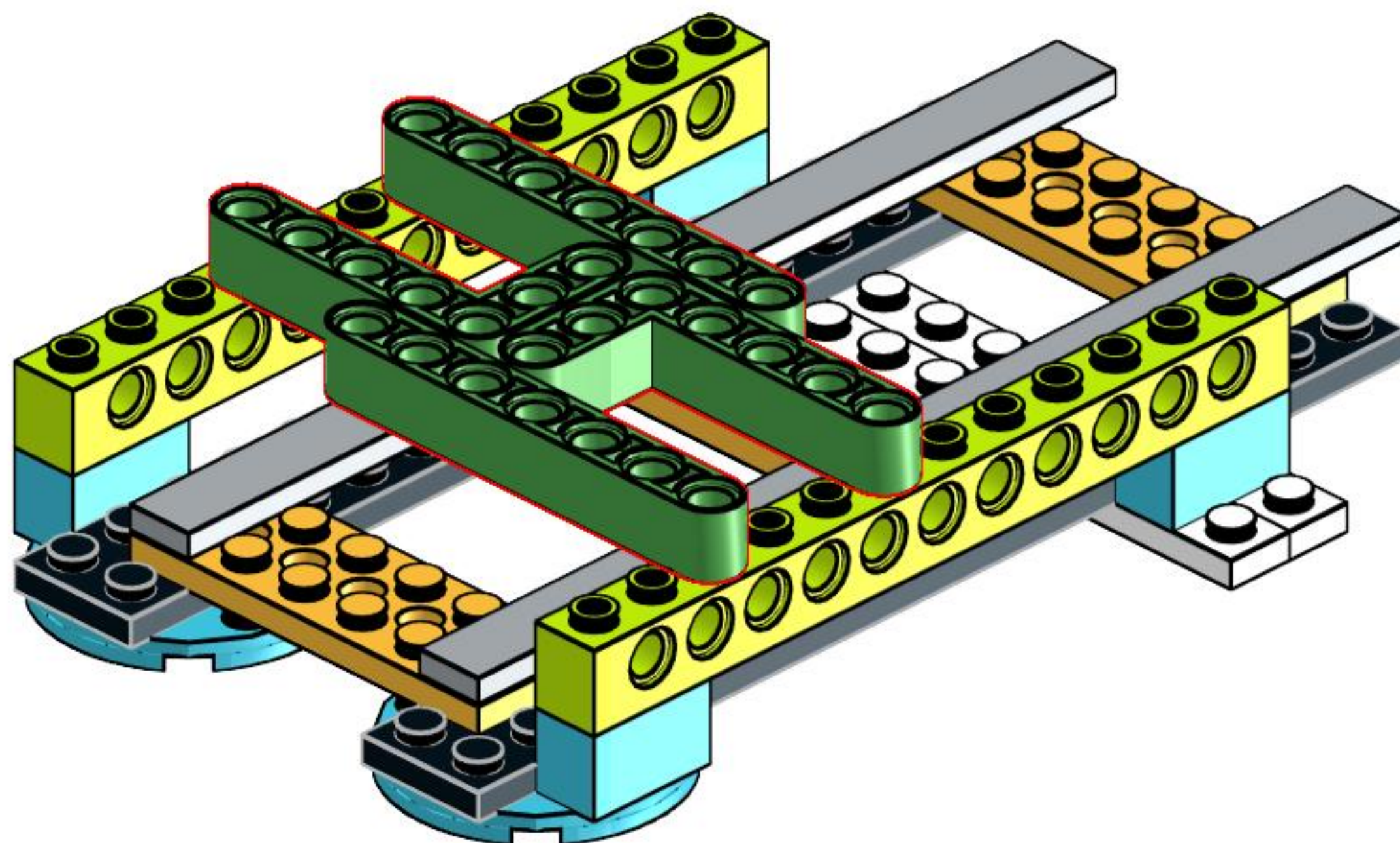
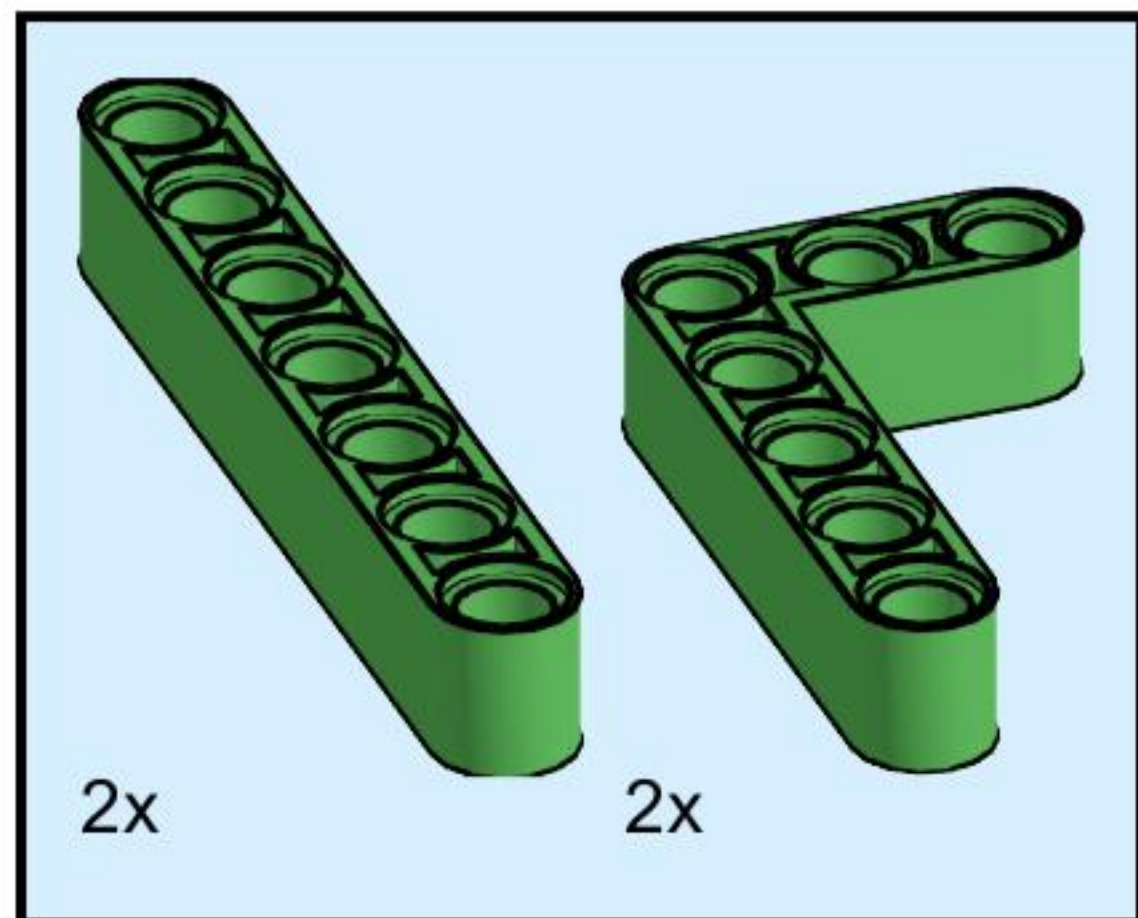



# 15

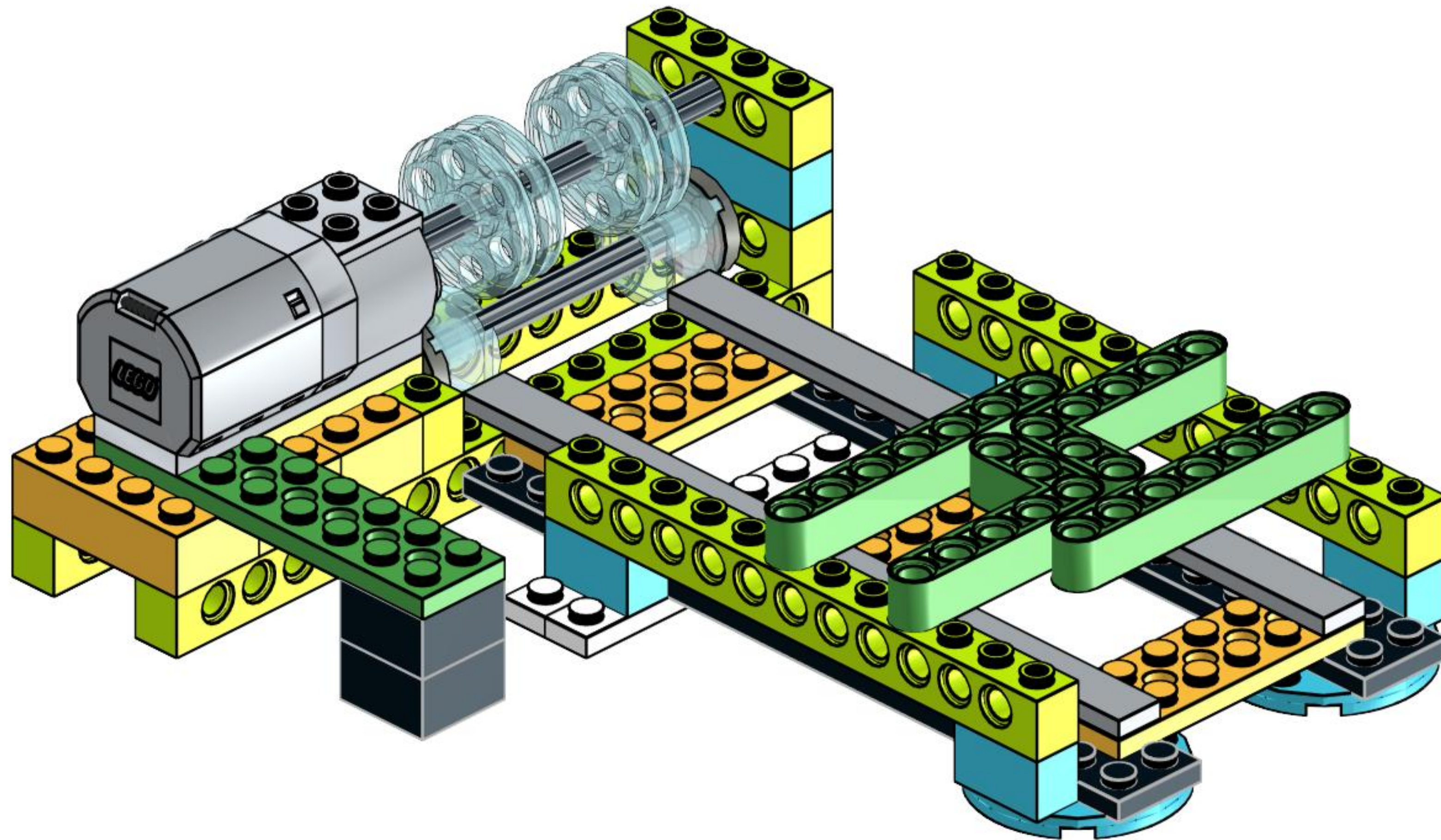



# 16

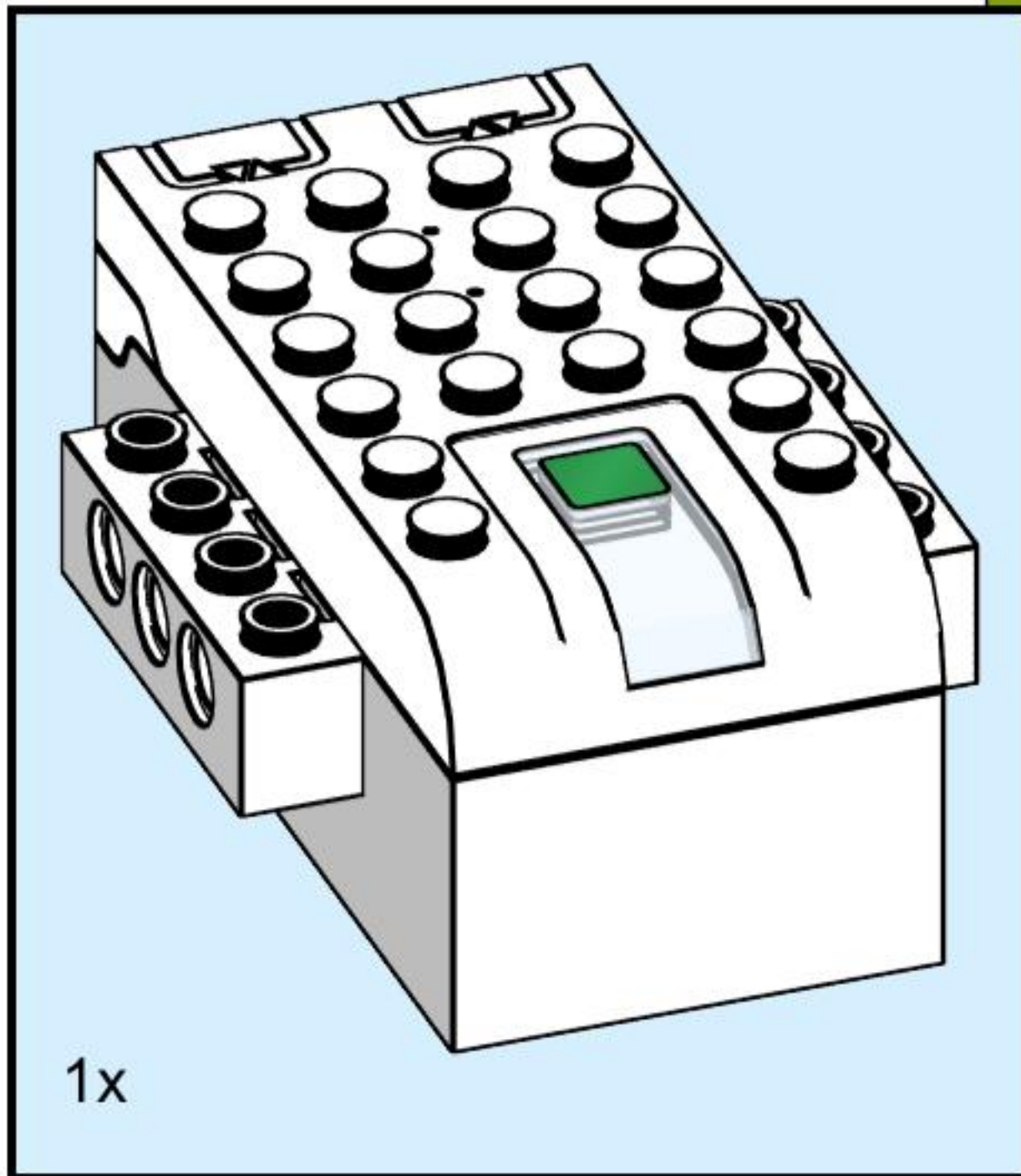
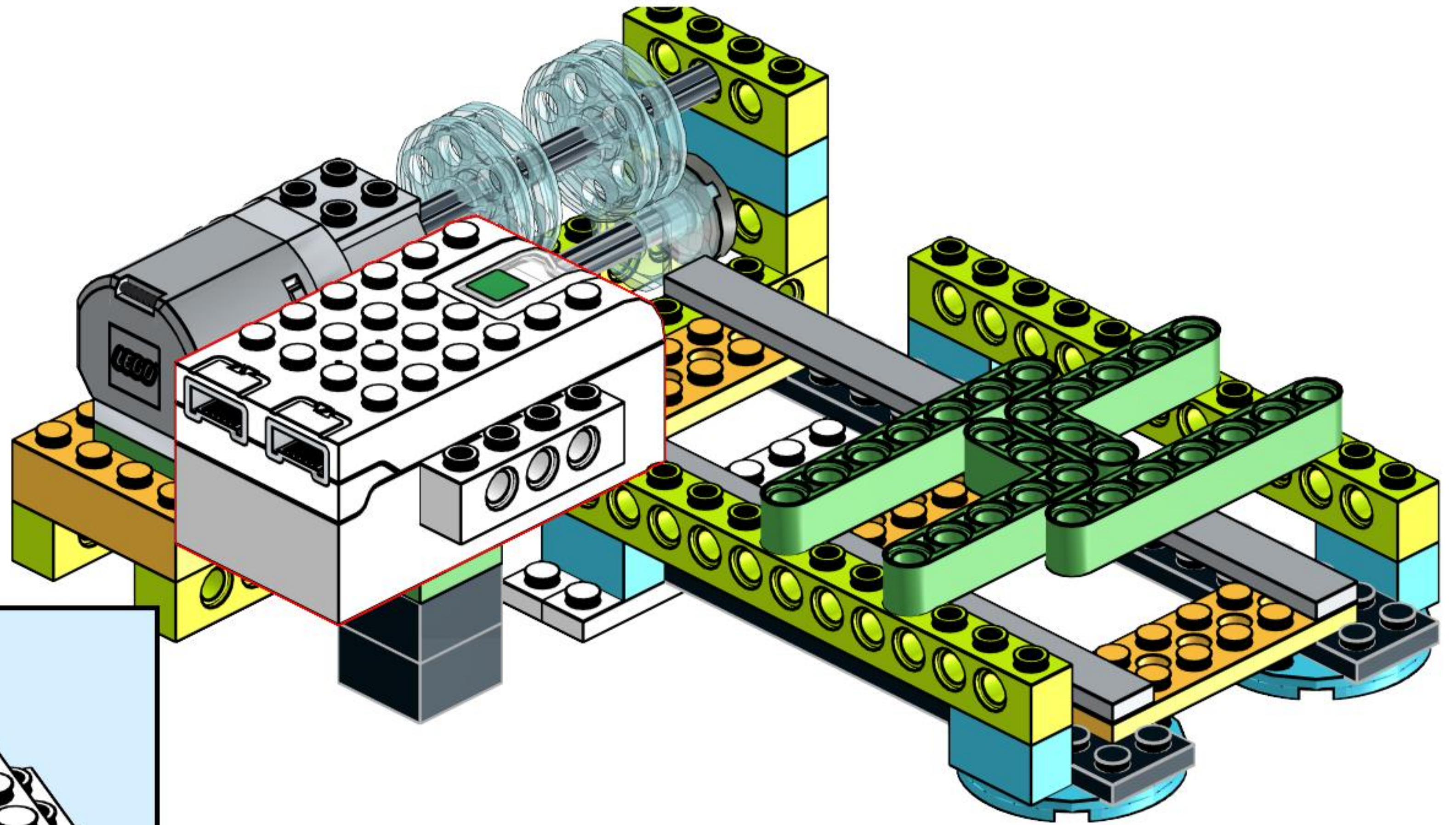

1x



# 17

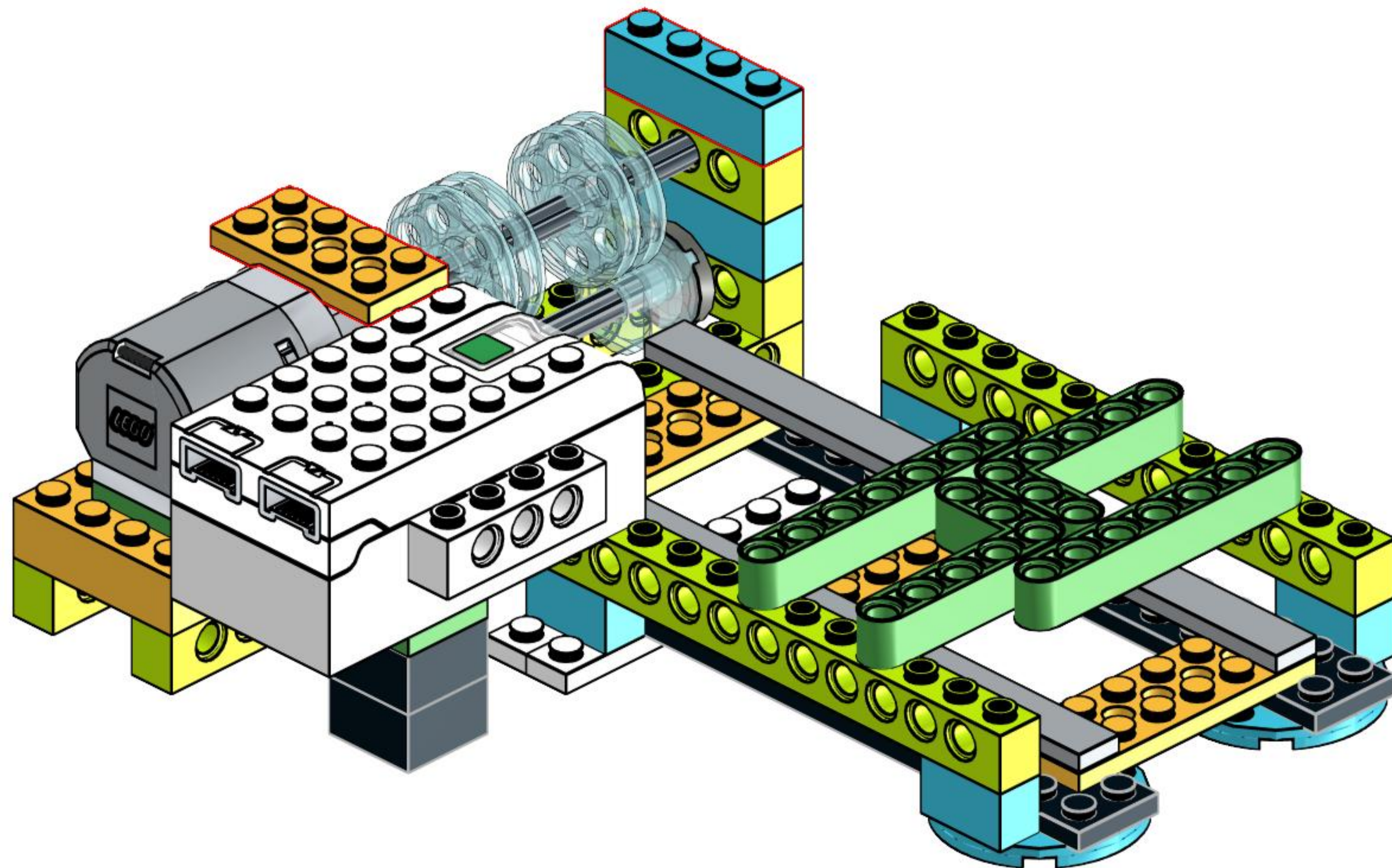
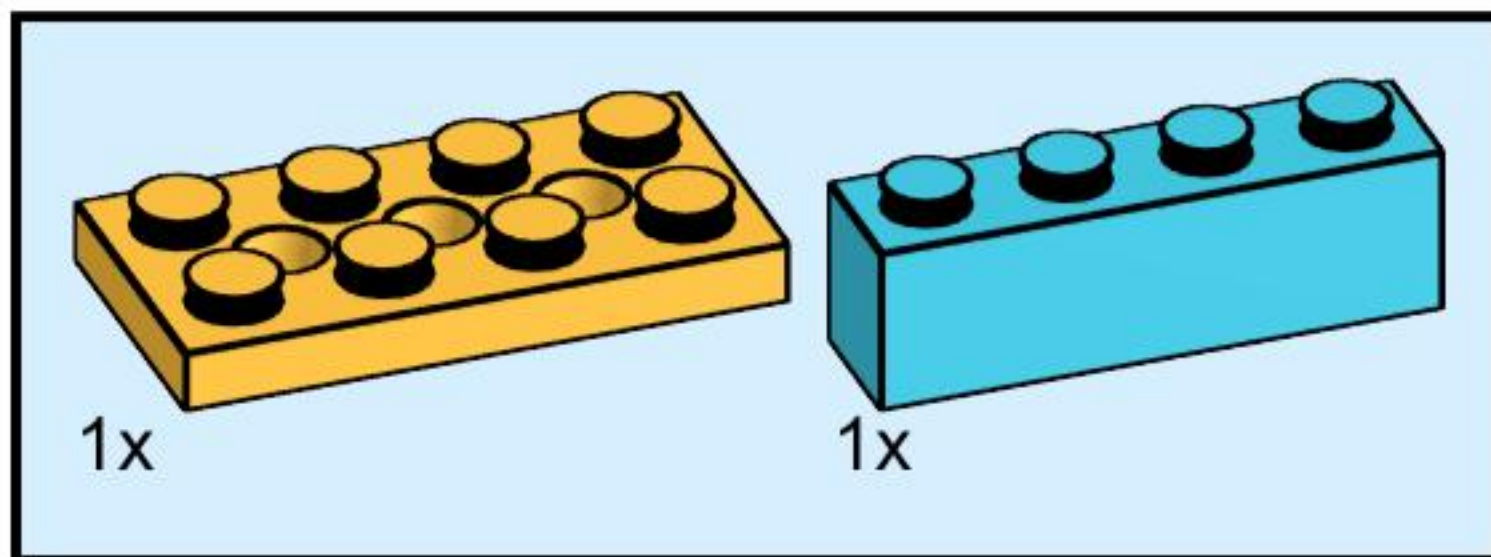



# 18

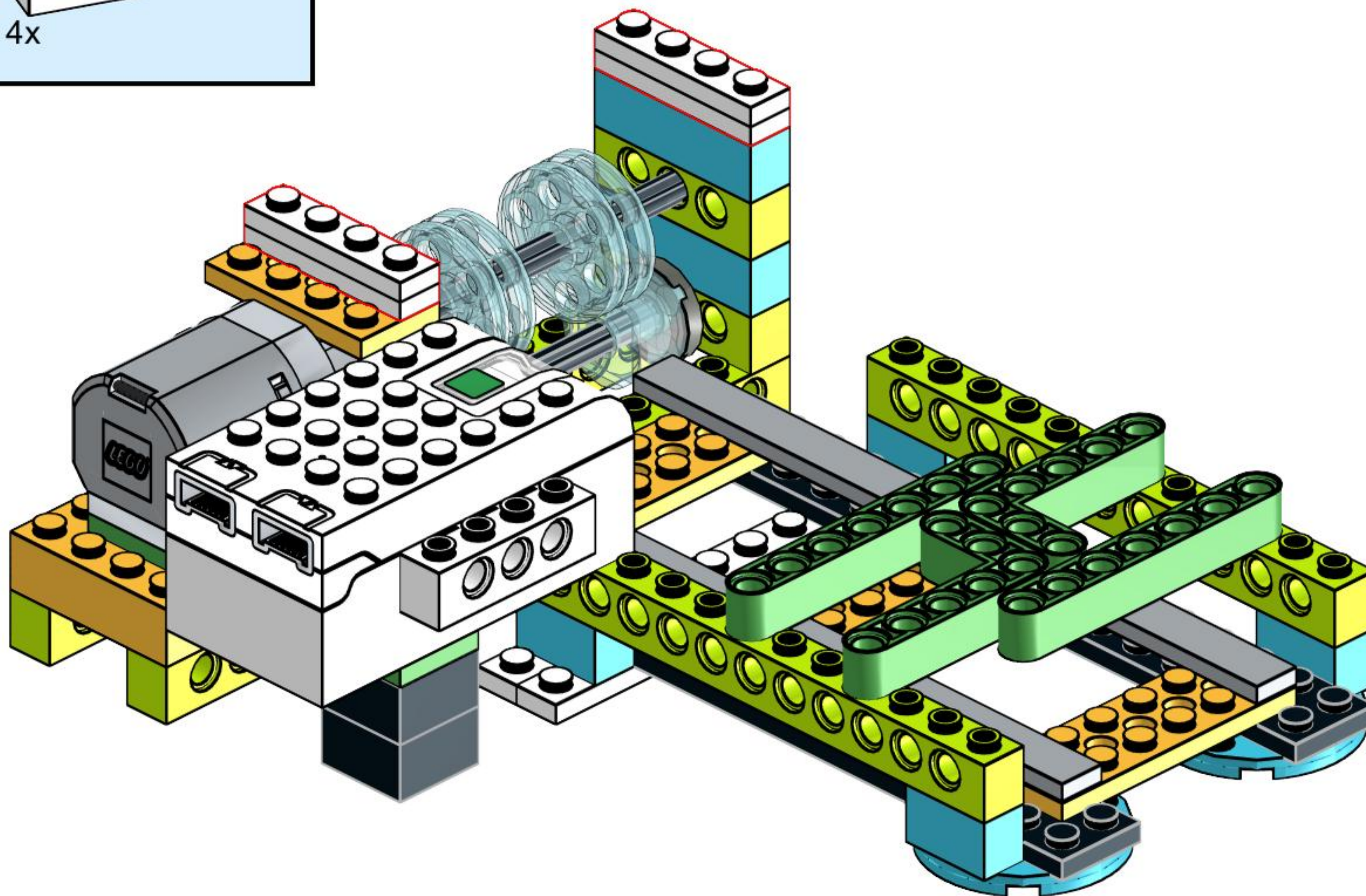
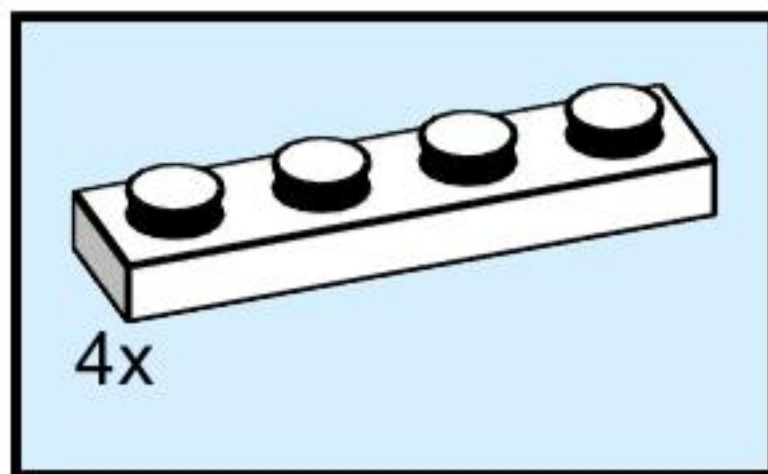



# 19

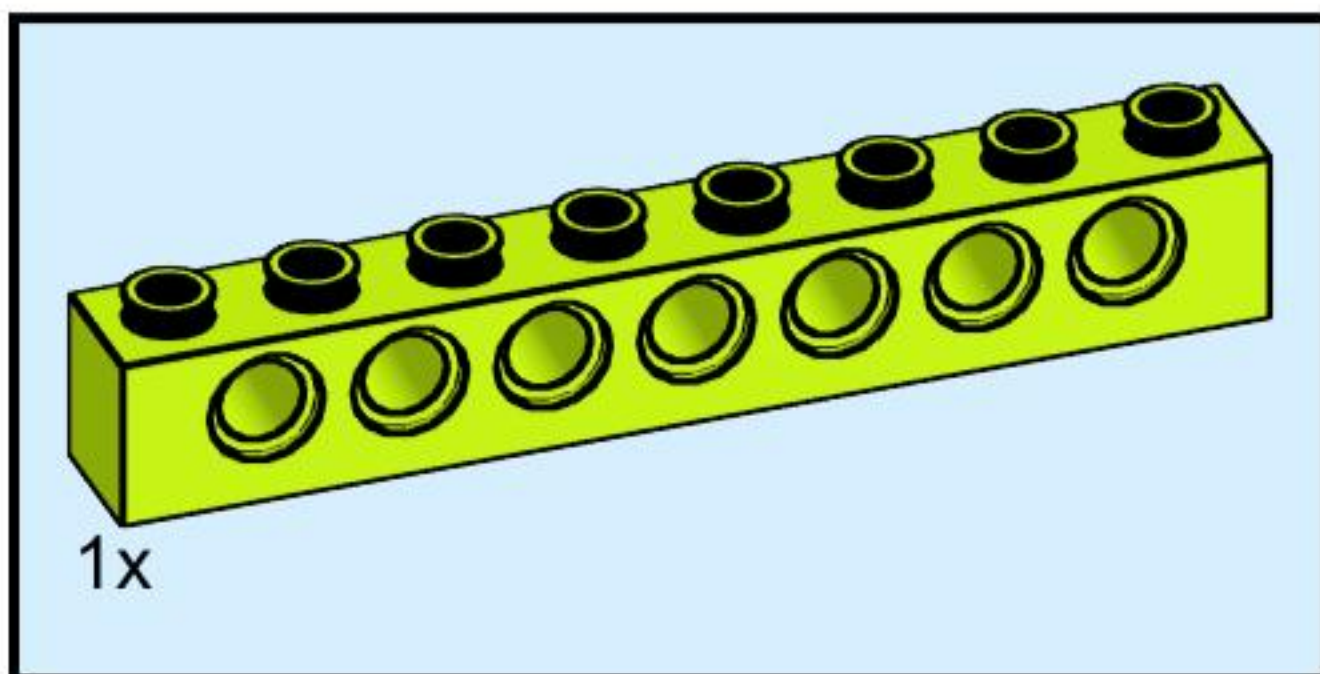
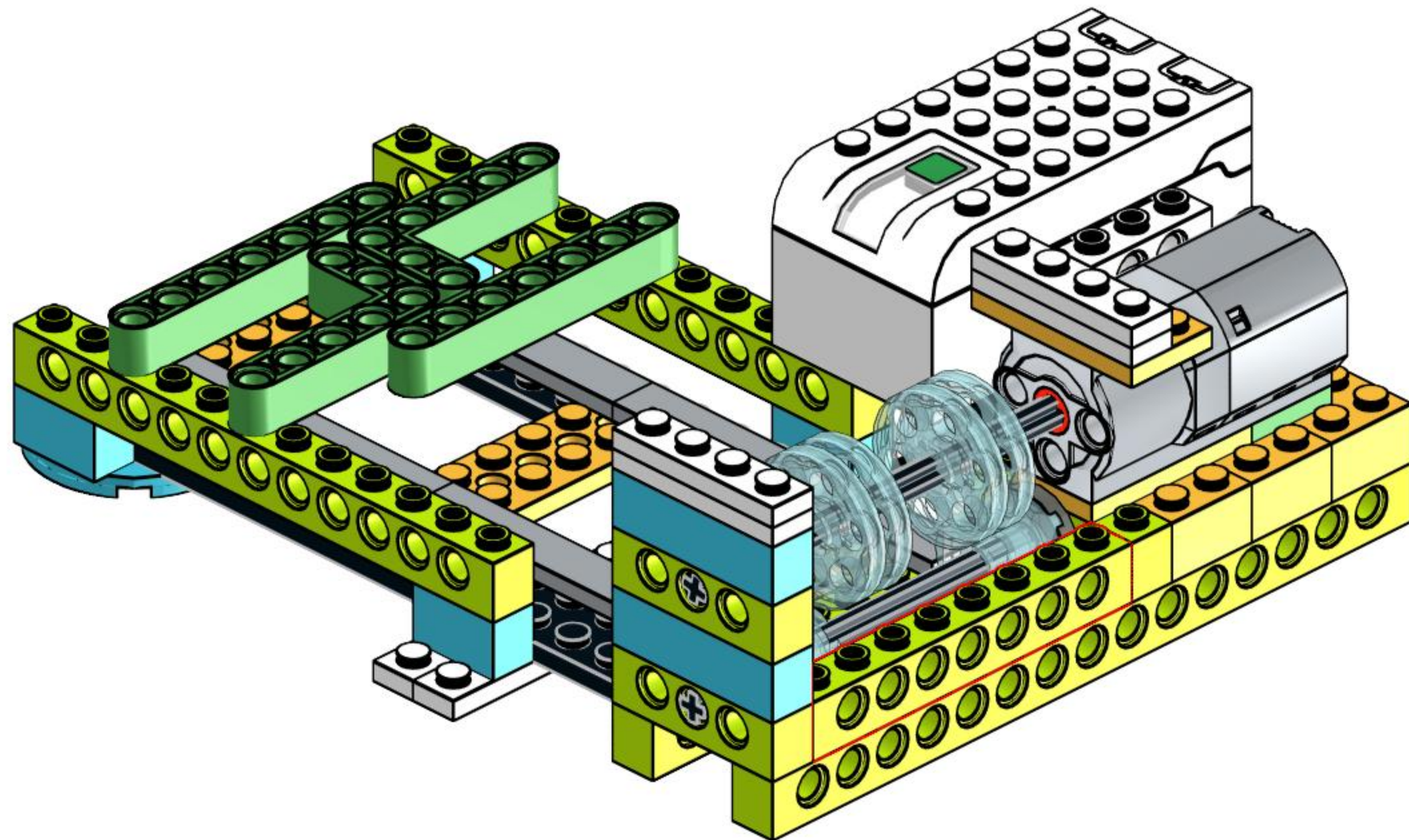



# 20

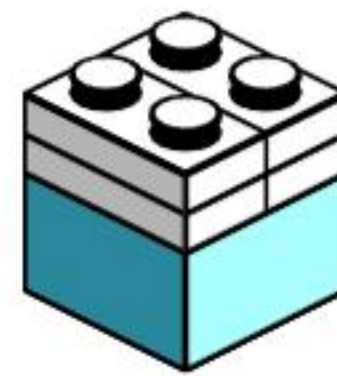
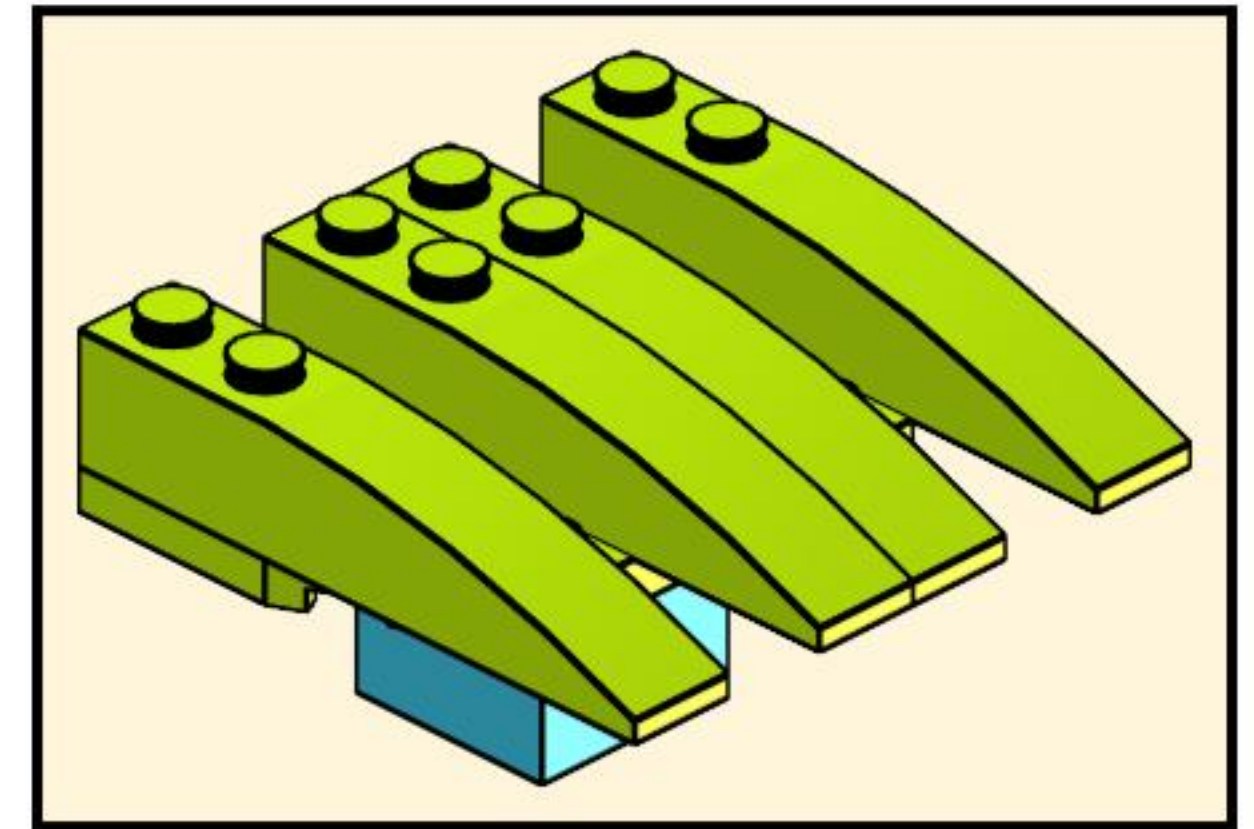
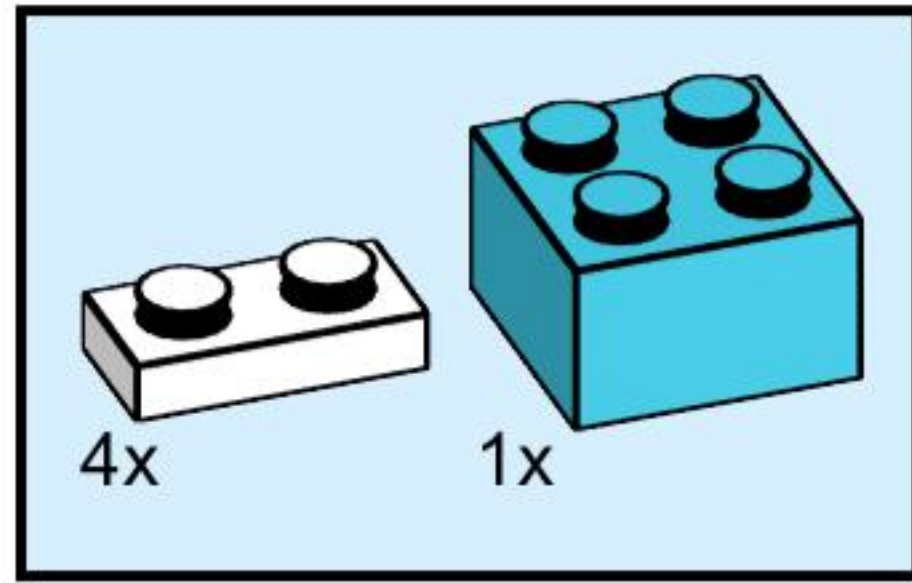



# 21

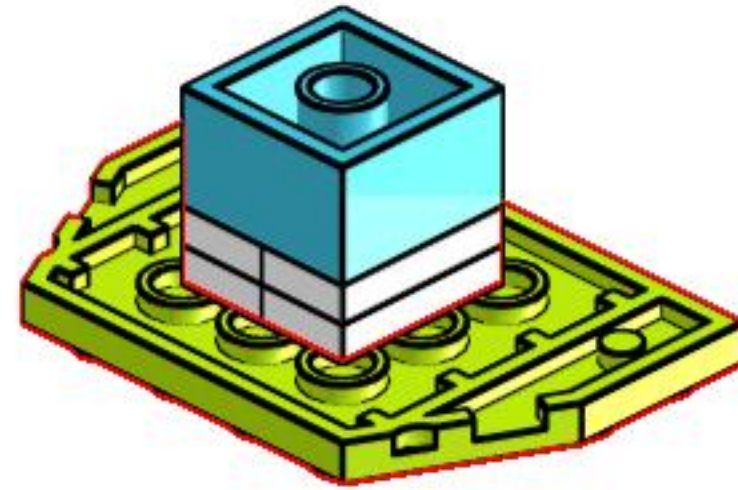
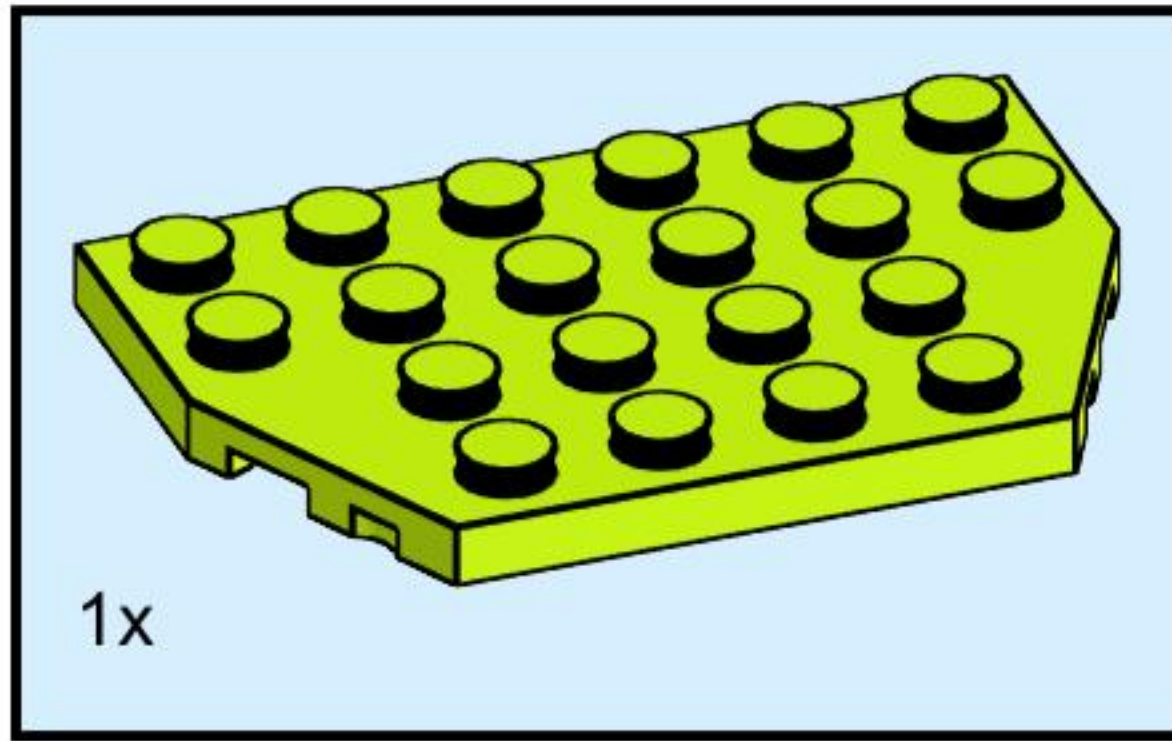



22

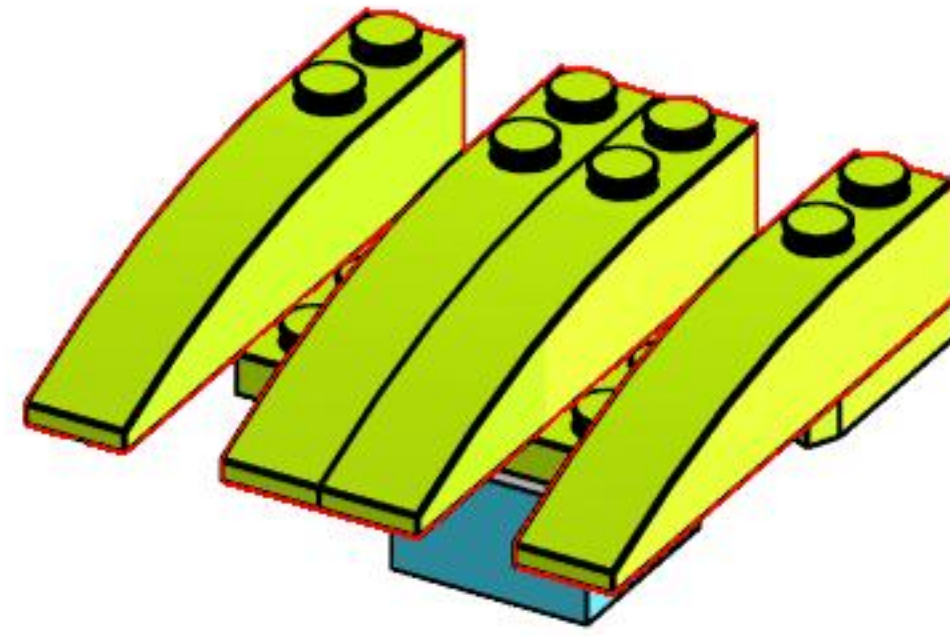
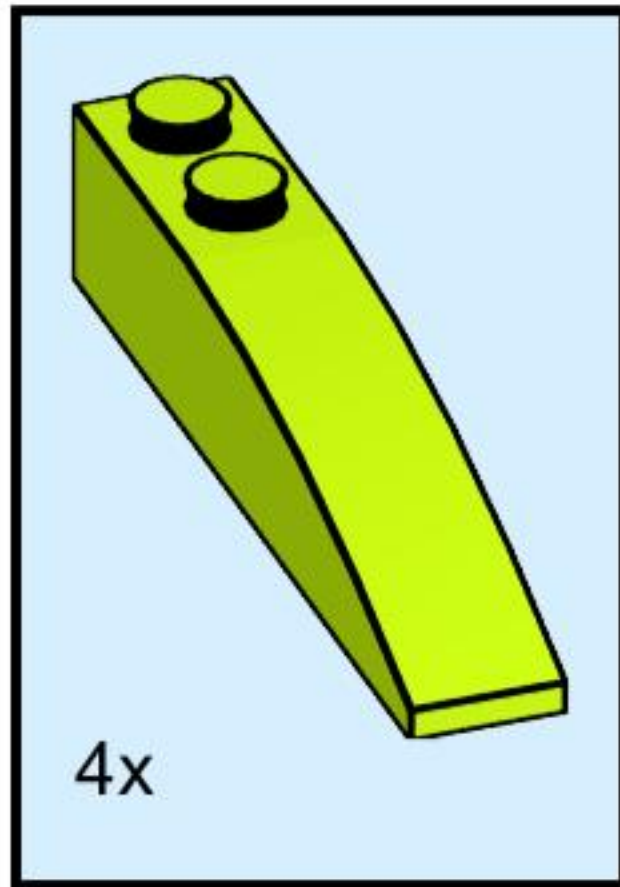



# 23

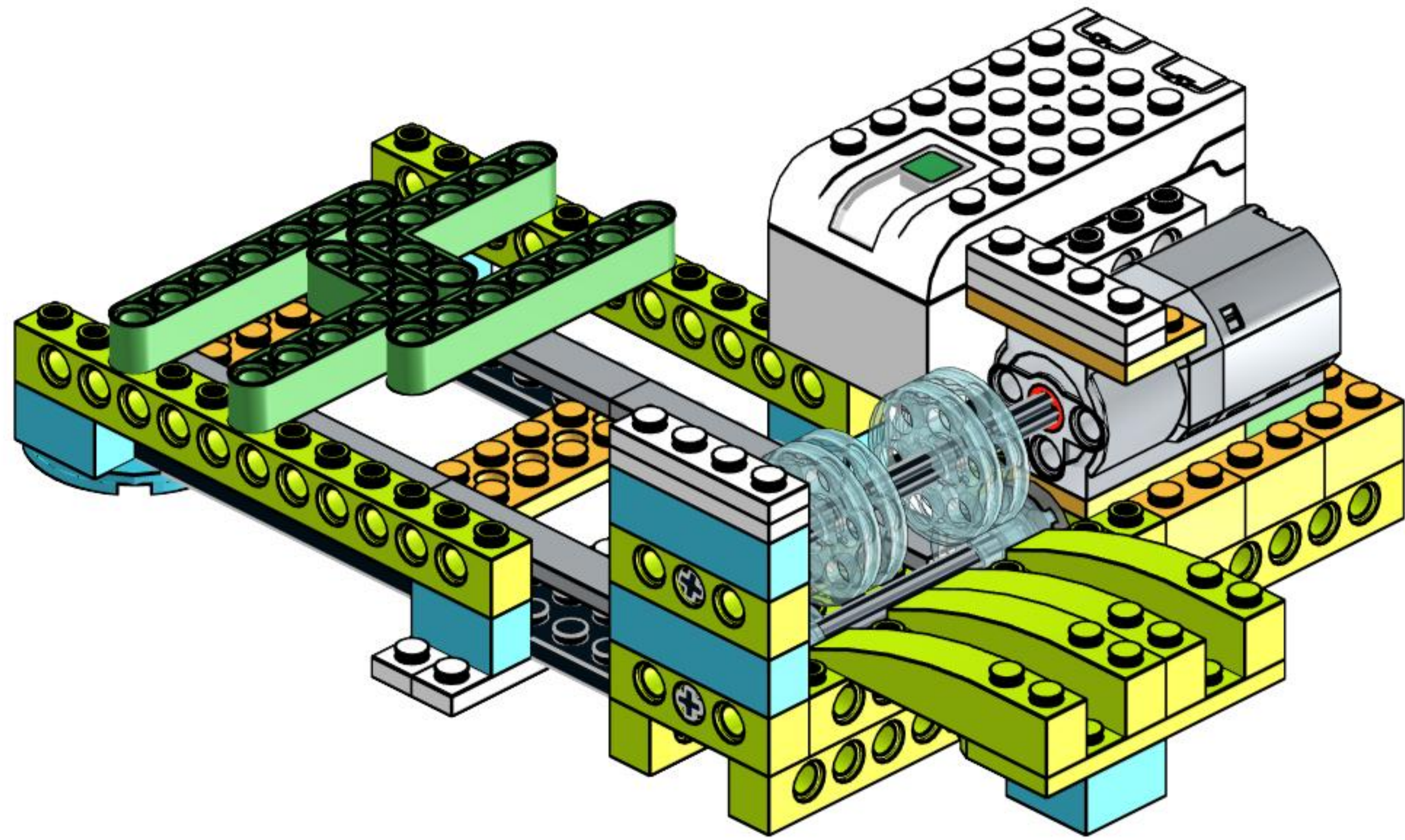



# 24

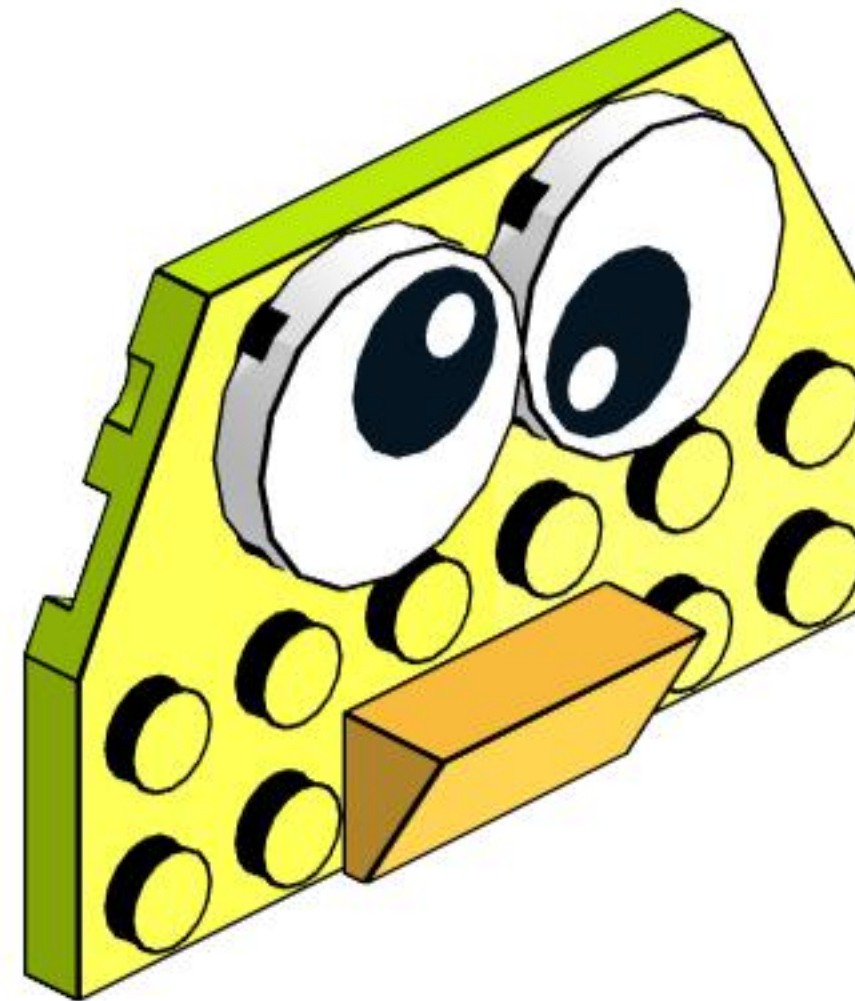
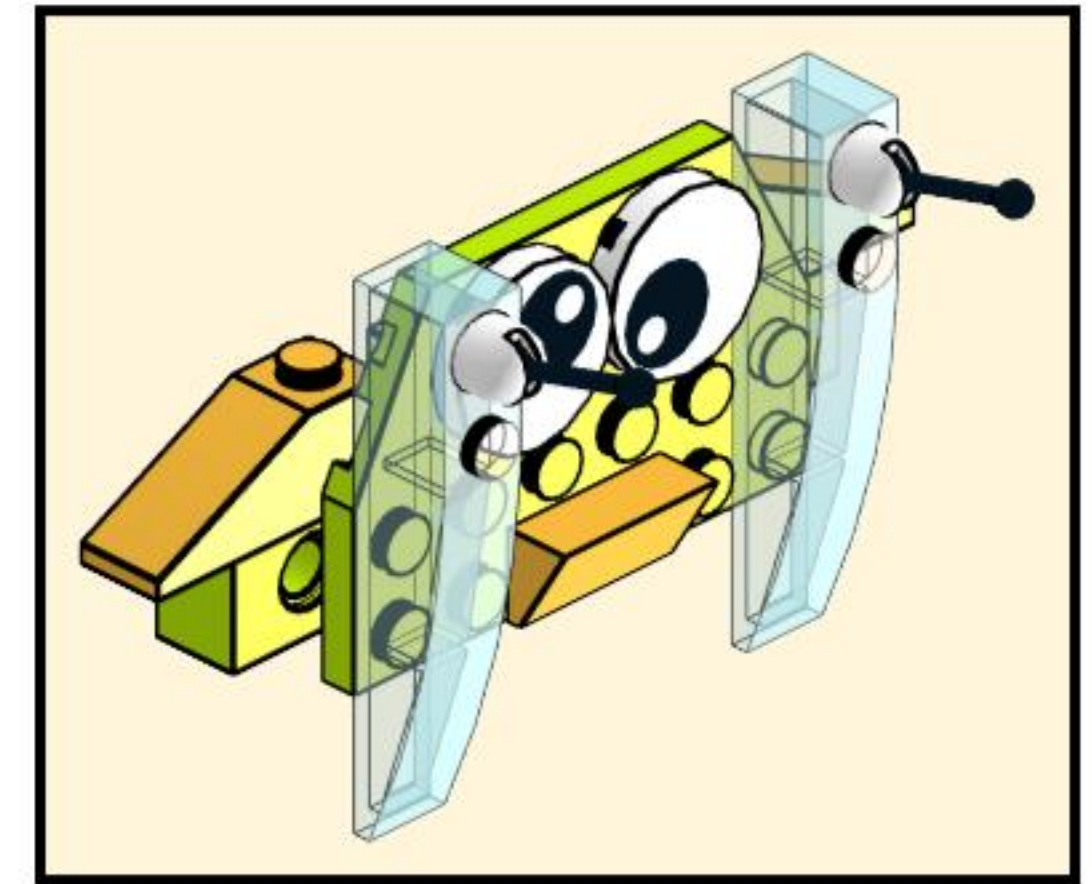
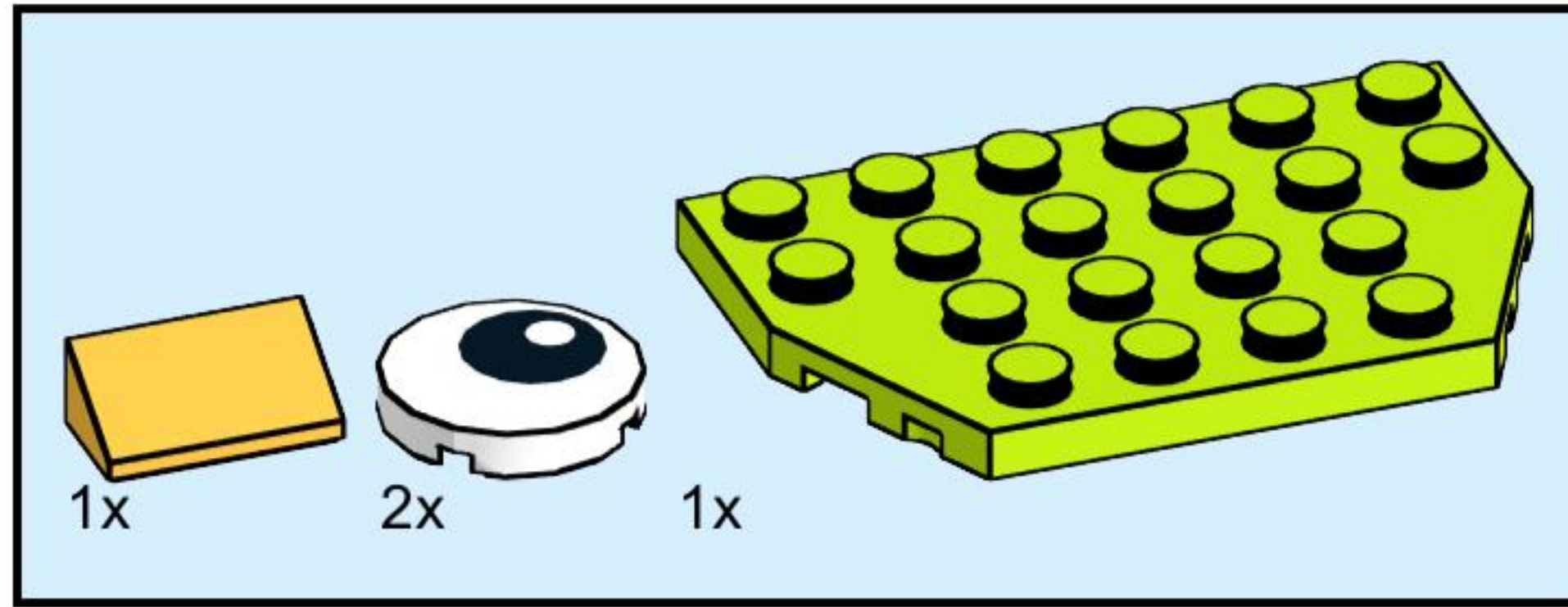



# 25

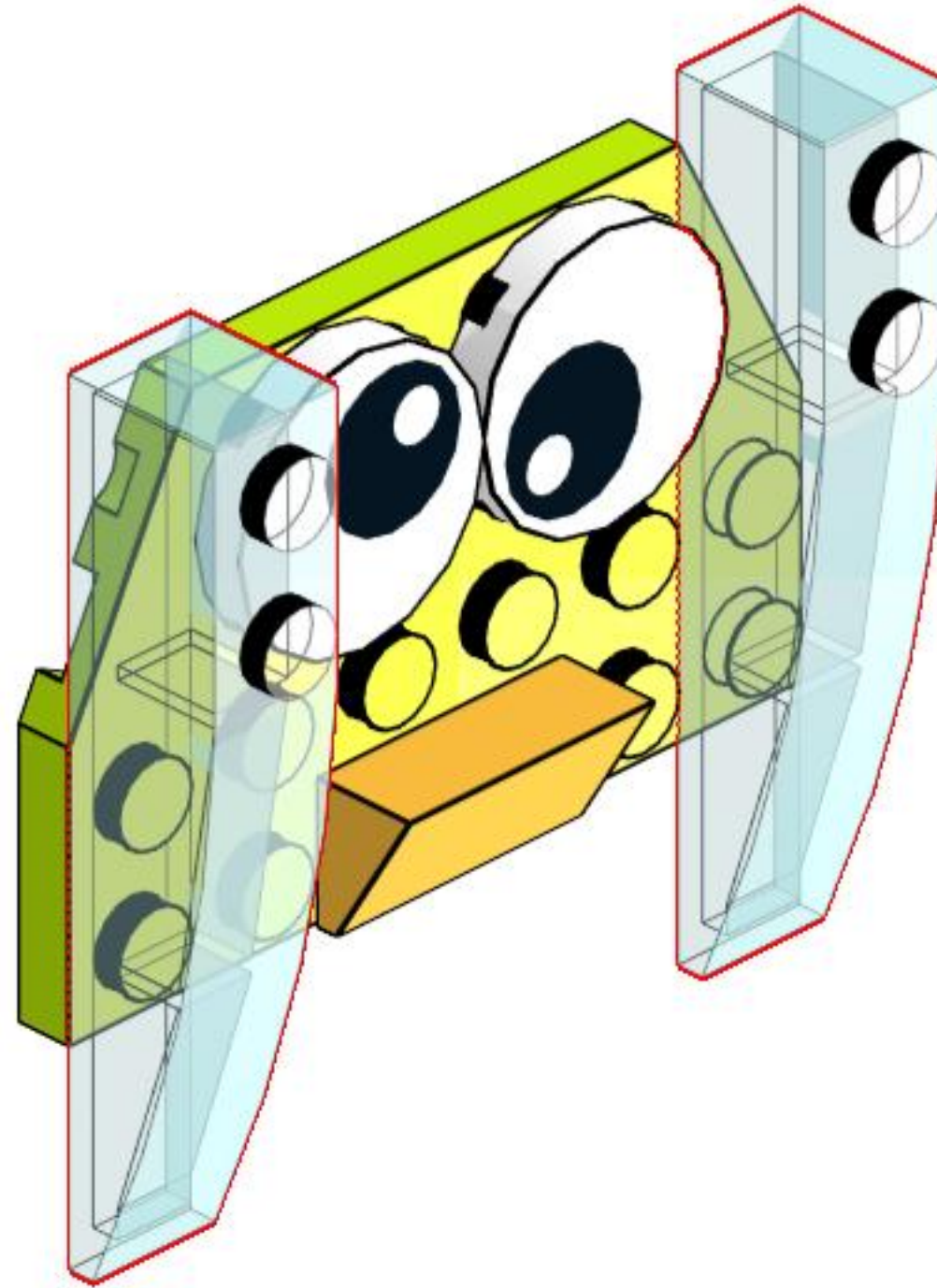
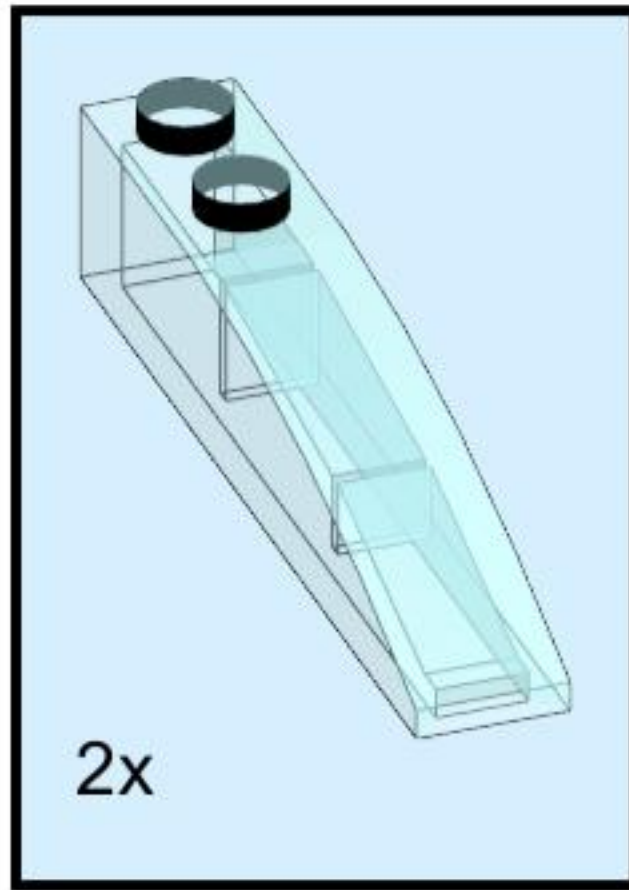



26

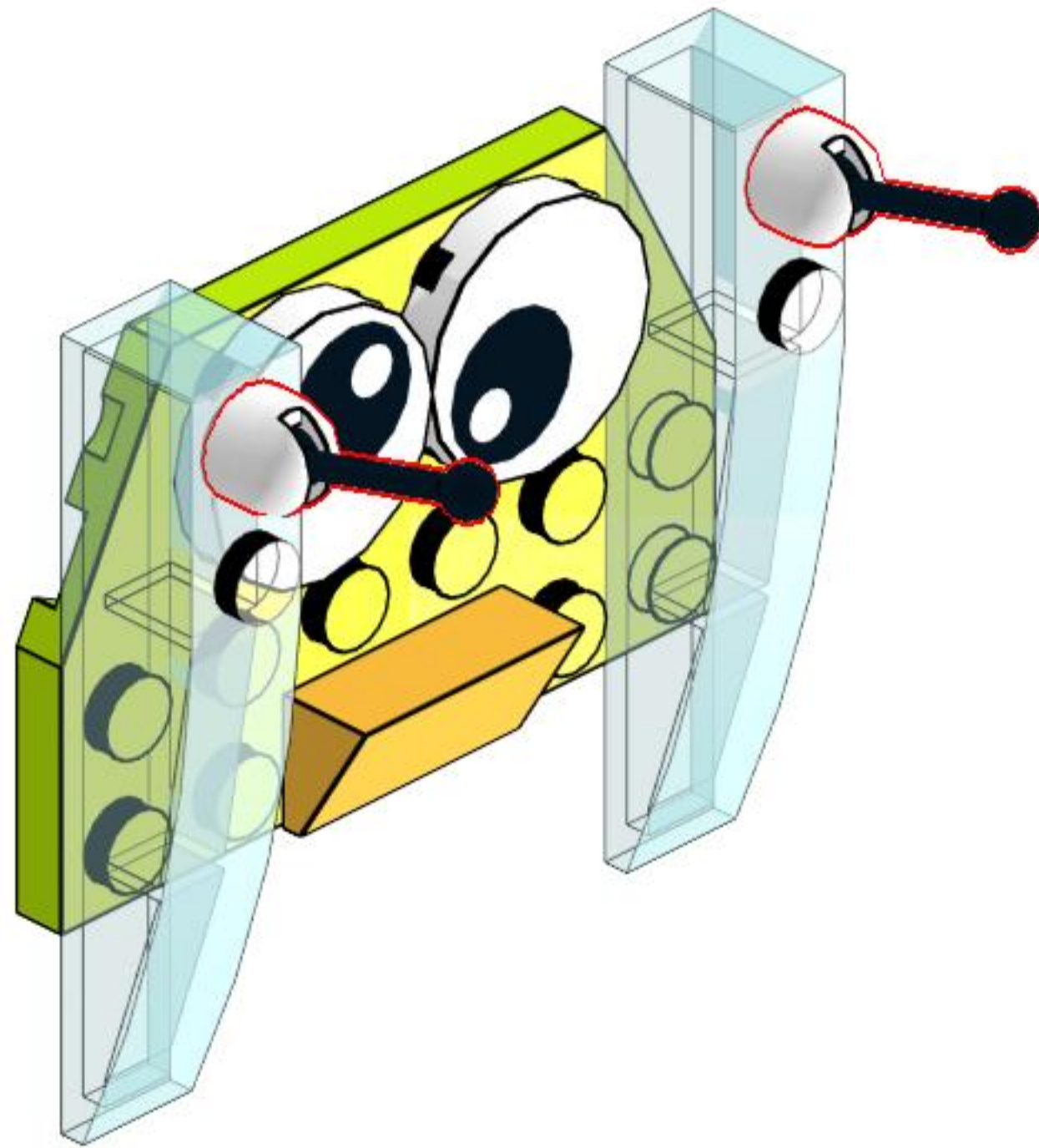



# 27

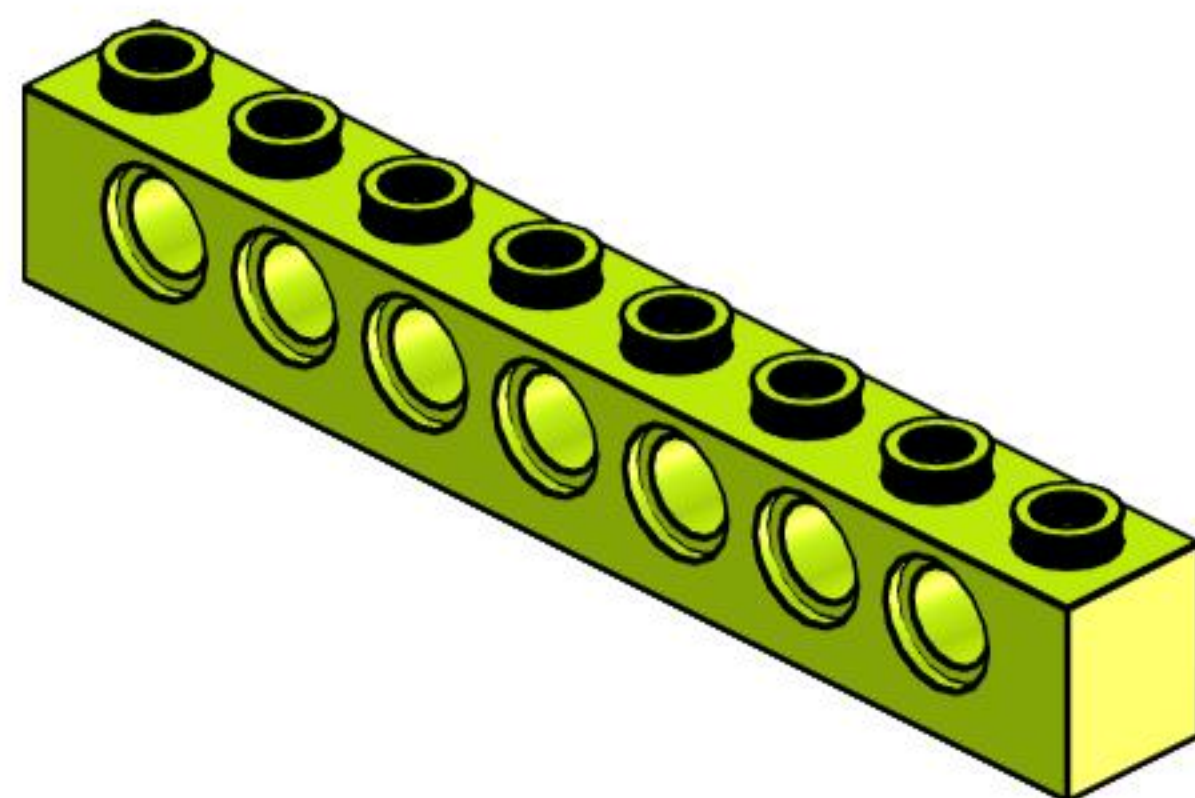
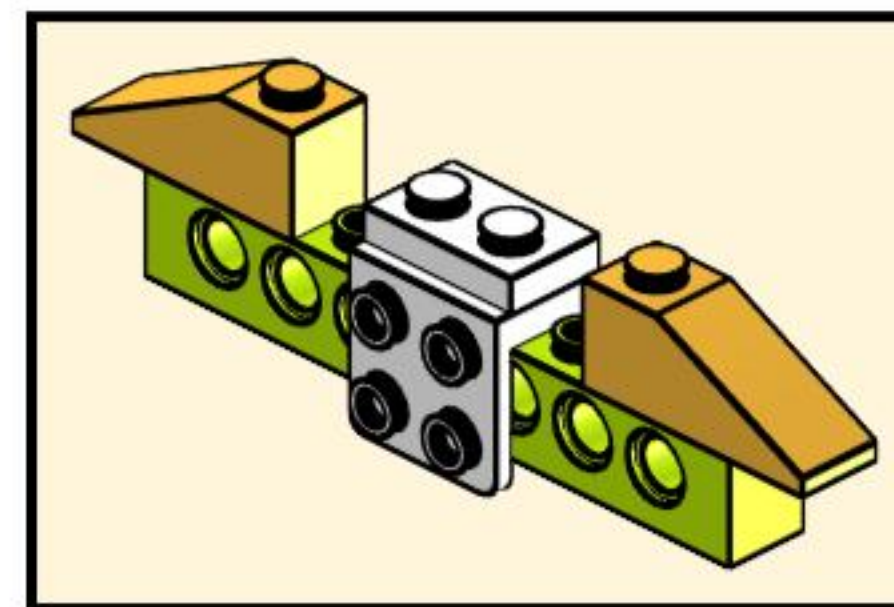
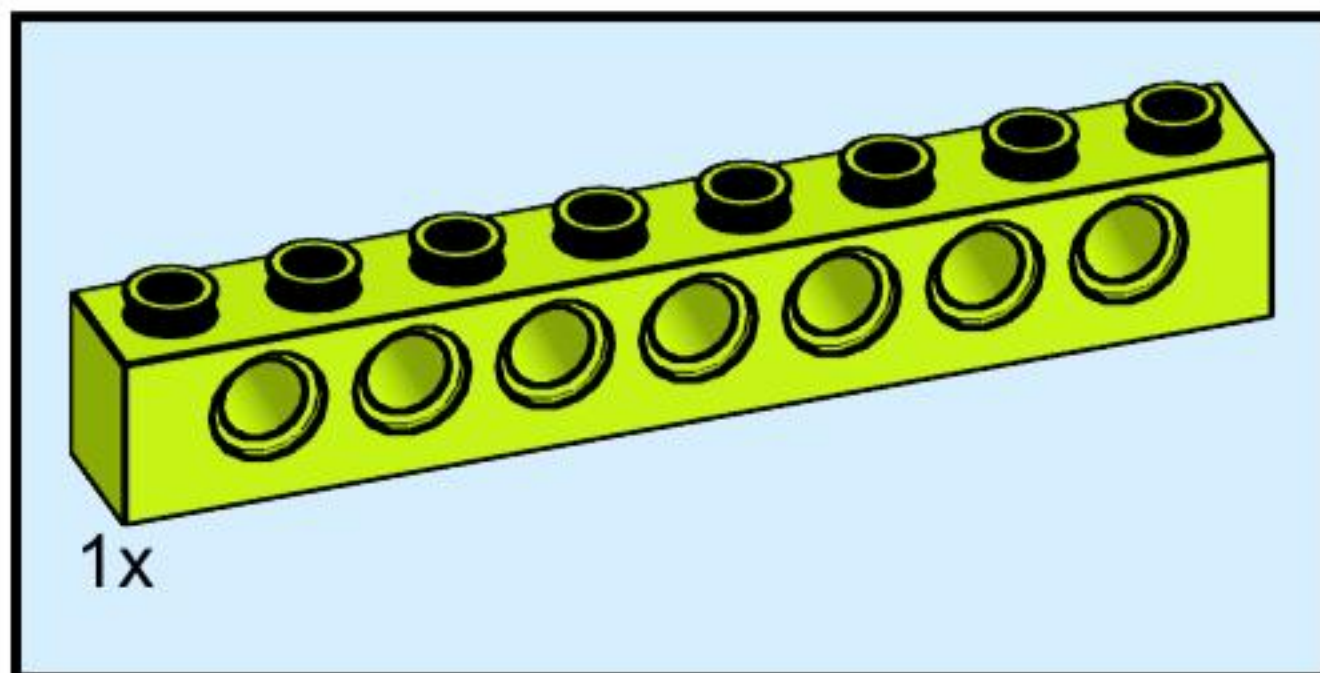



28

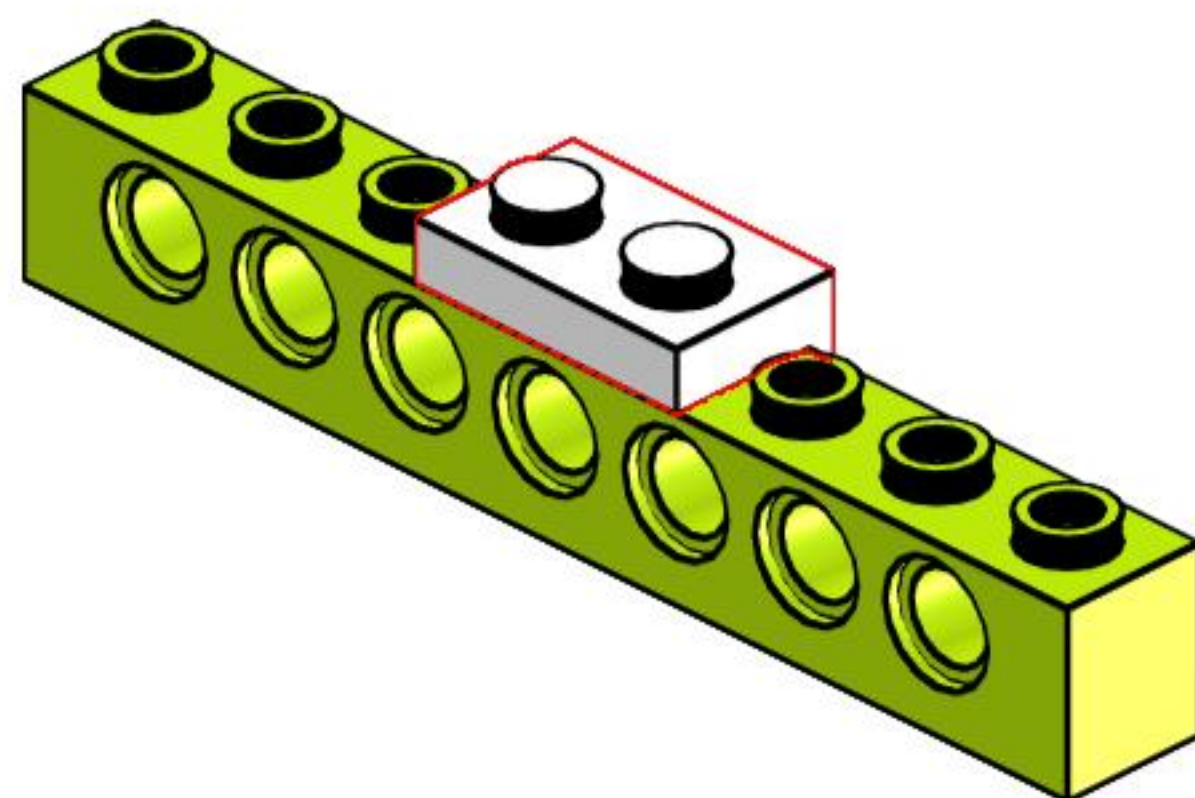
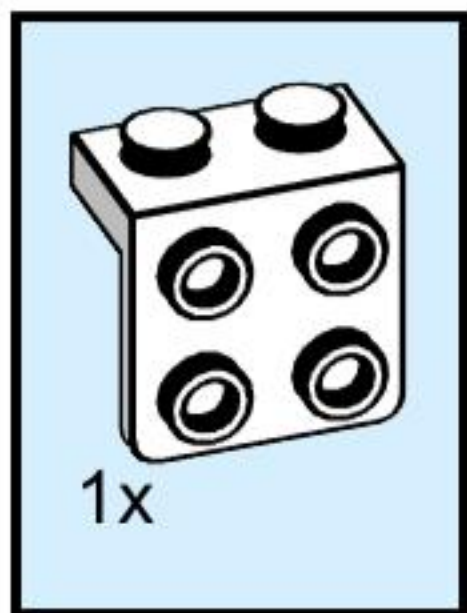



29

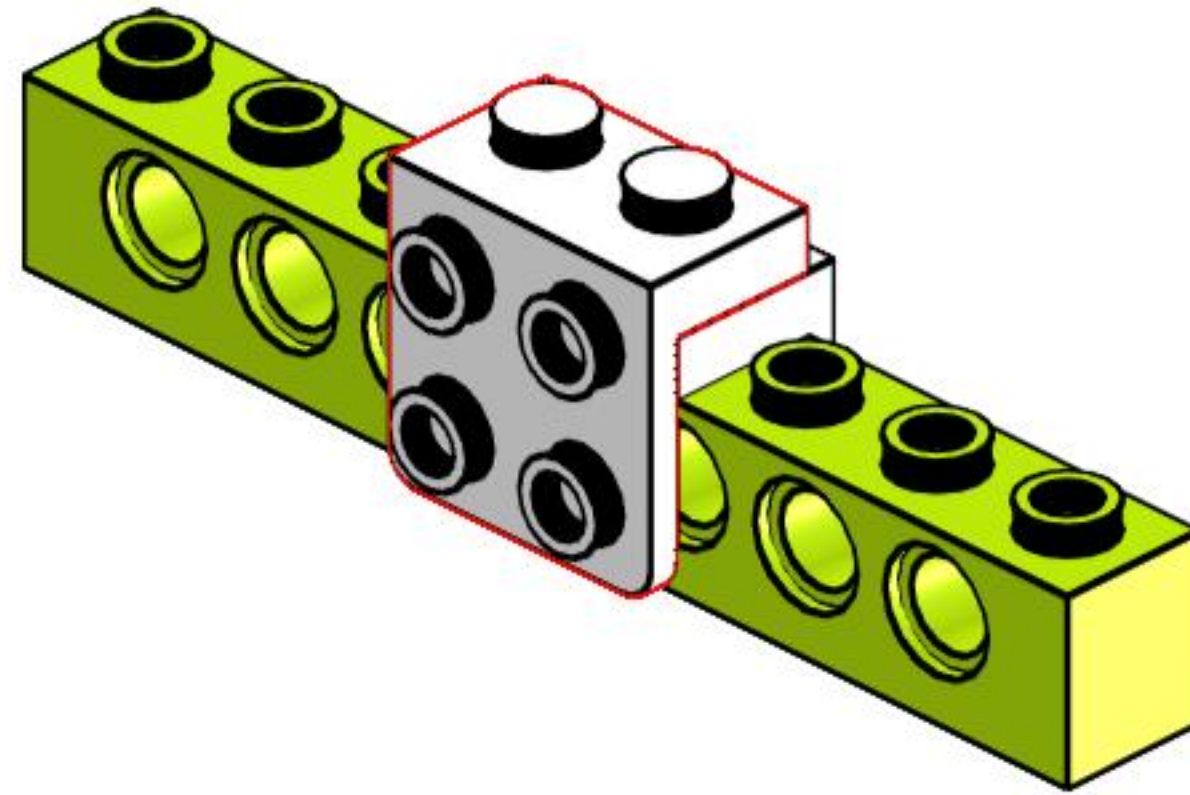
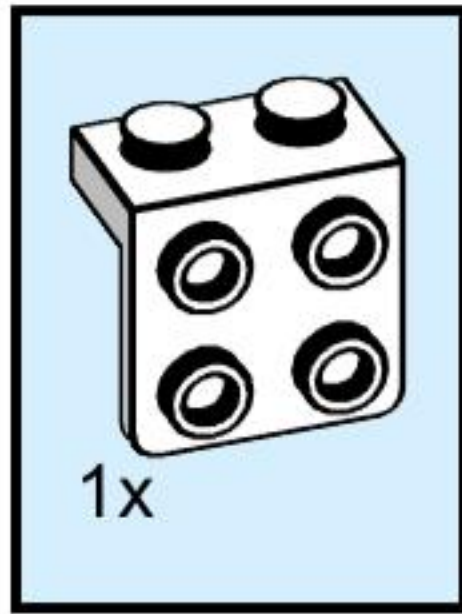



30

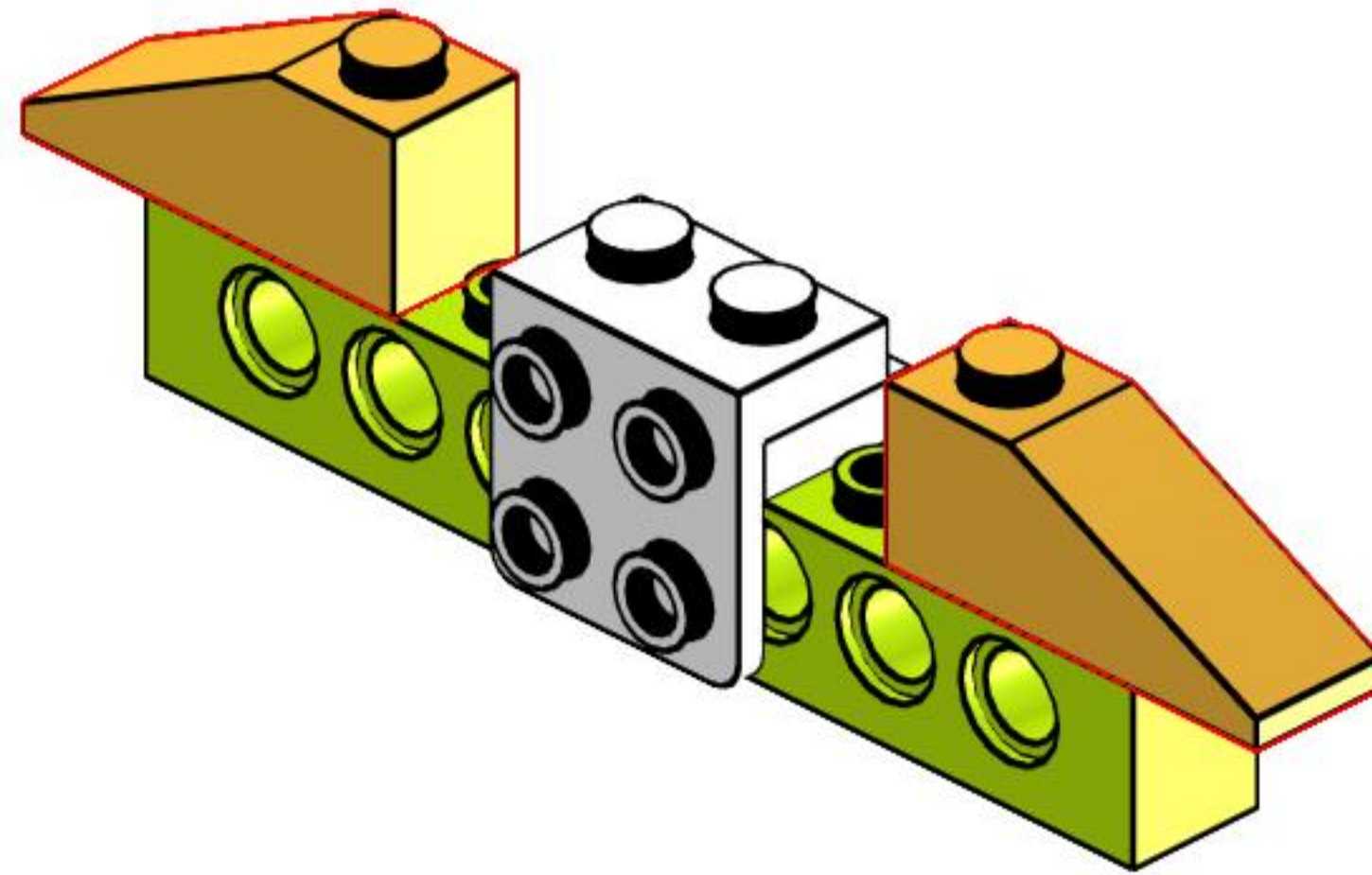
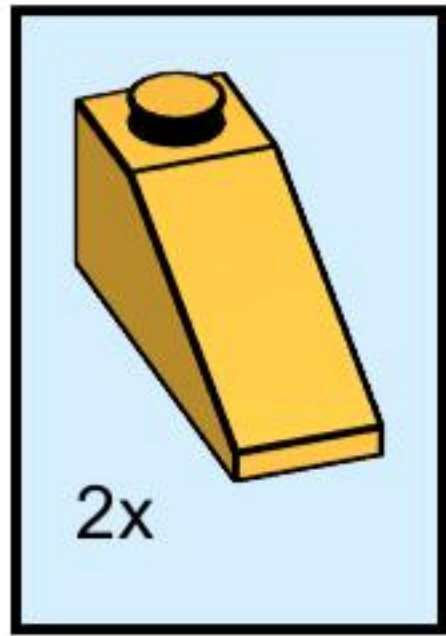



31

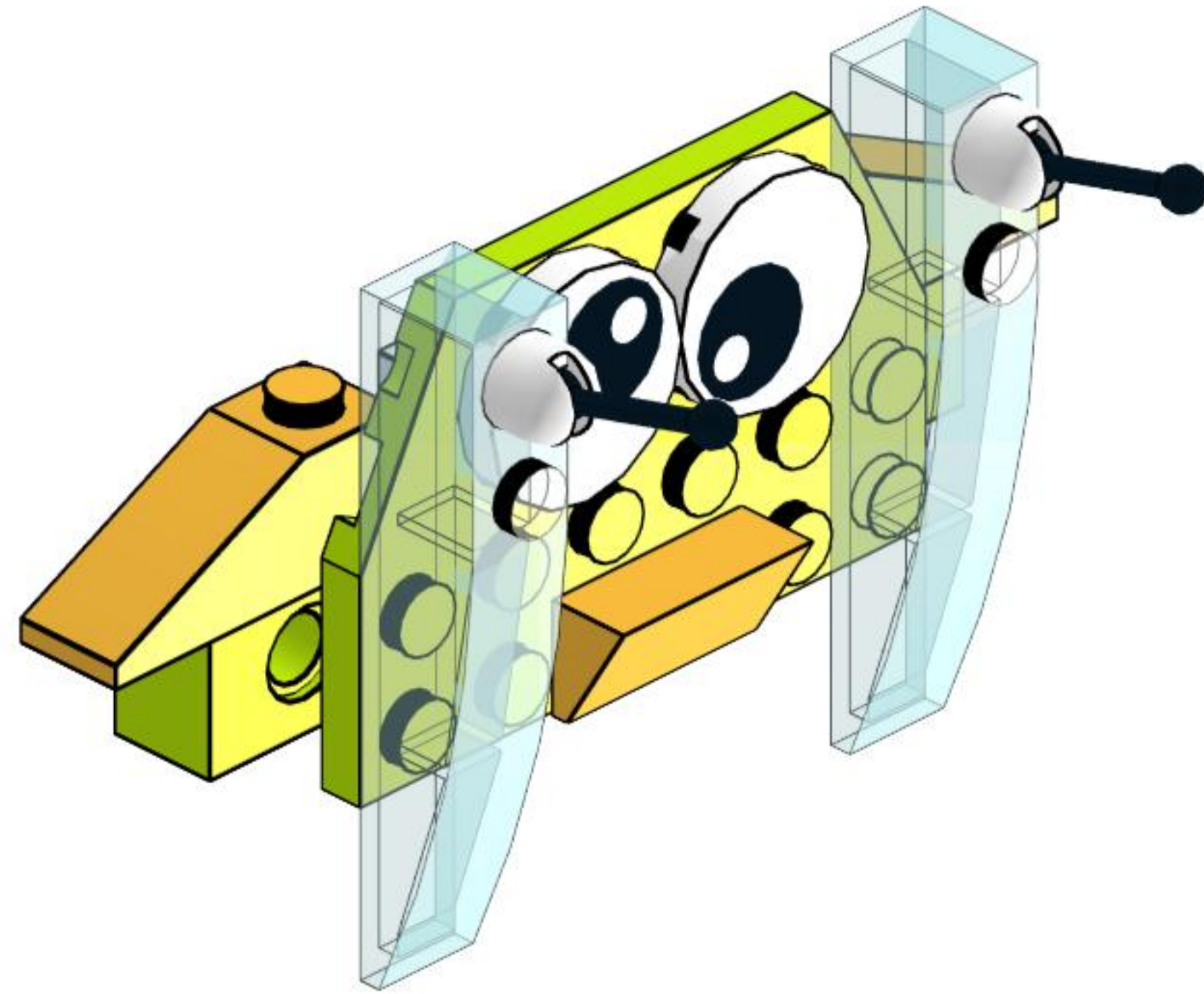



32

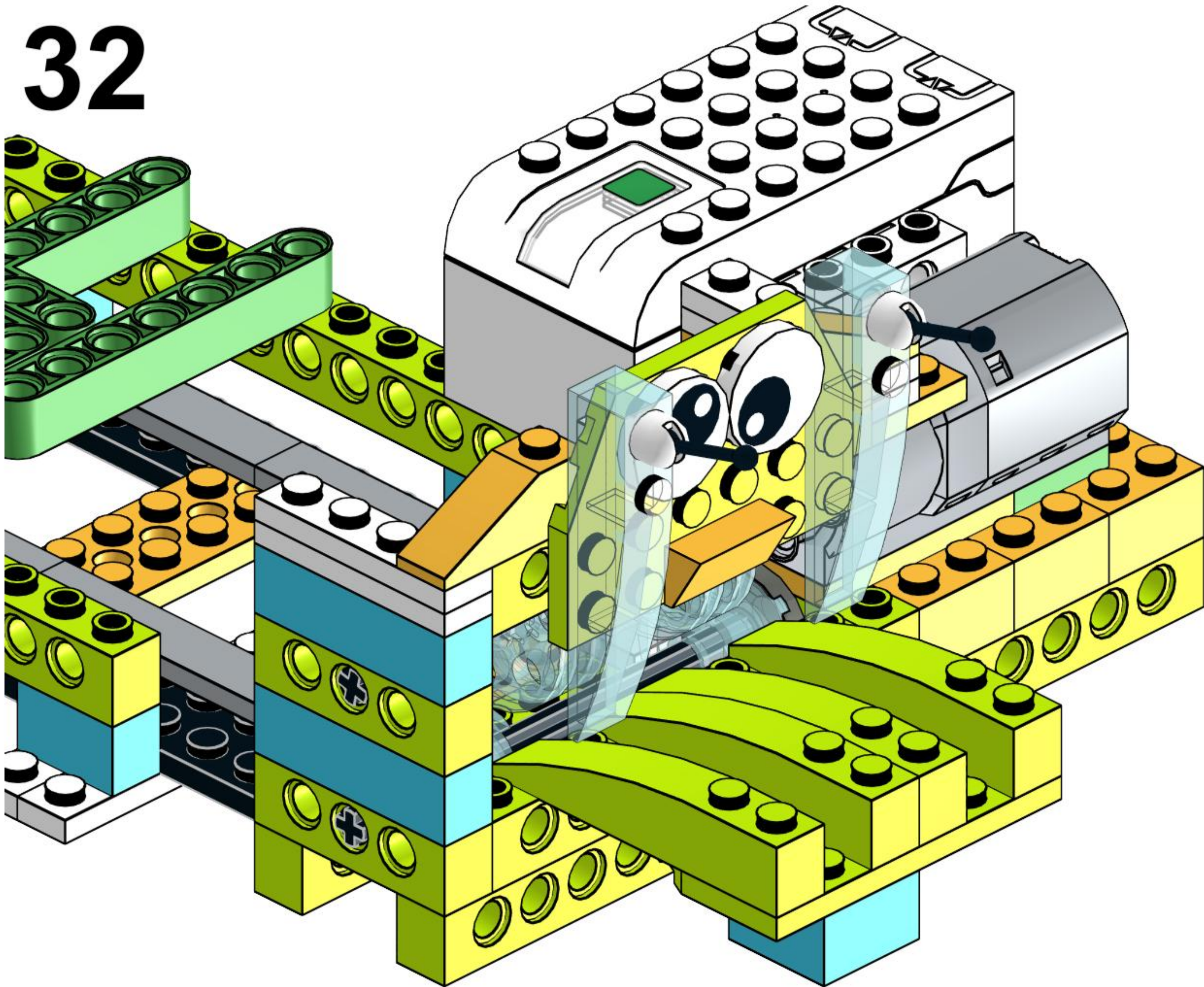



# 33

