

45300

LEGO and the LEGO logo are trademarks of the/son/ des marques de commerce
du/son marcas registradas de LEGO Group. ©2015 The LEGO Group. 088360.



education



45300

LEGO and the LEGO logo are trademarks of the/son des marques de commerce
du/son marcas registradas de LEGO Group. ©2015 The LEGO Group. 088360.



education

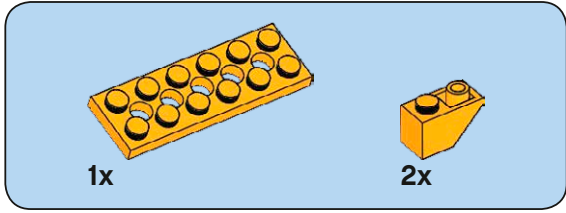

1

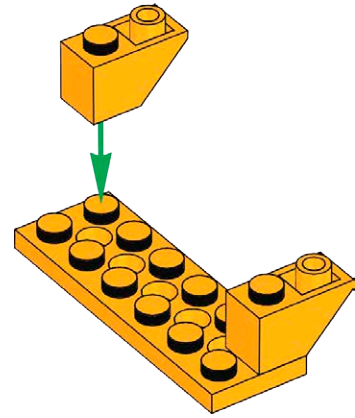

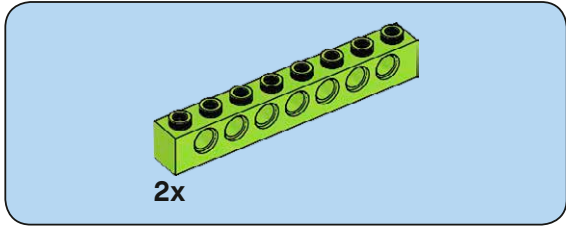

2

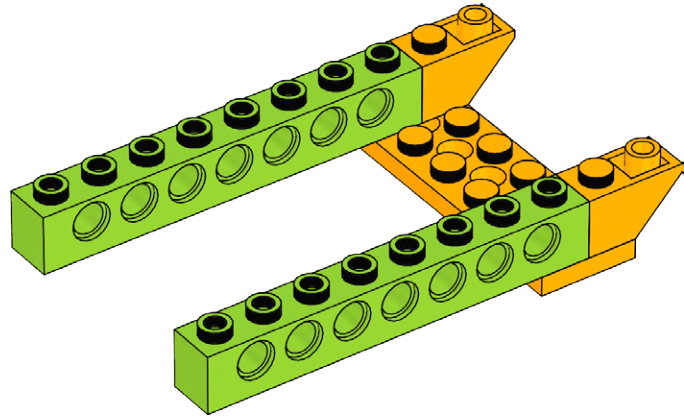

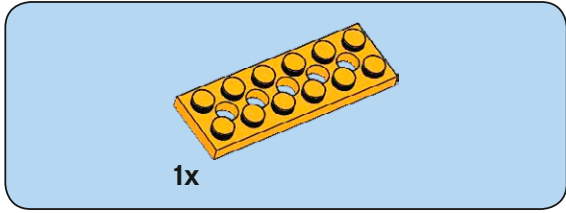

3

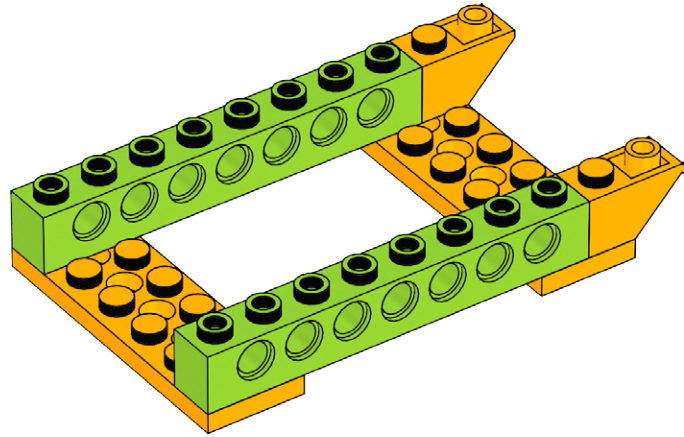

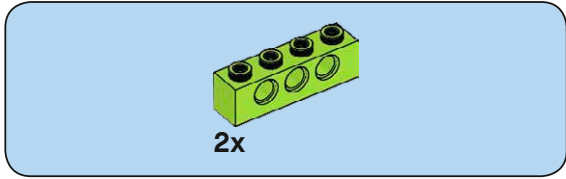

4

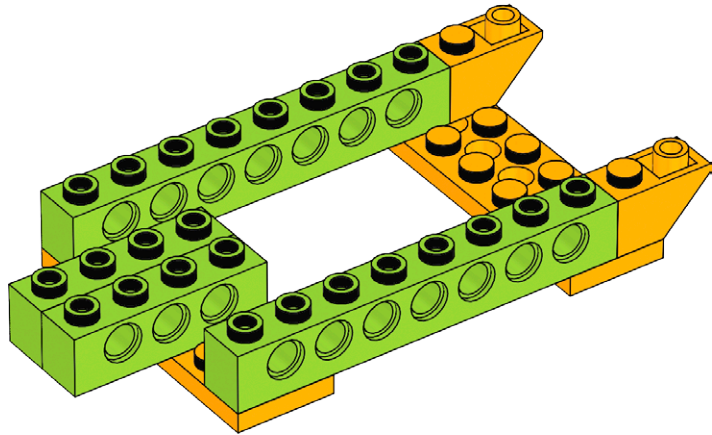

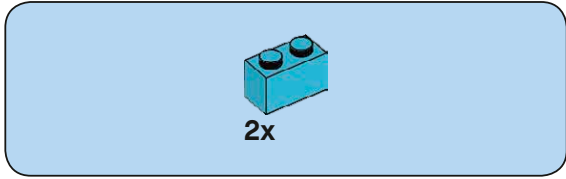

6

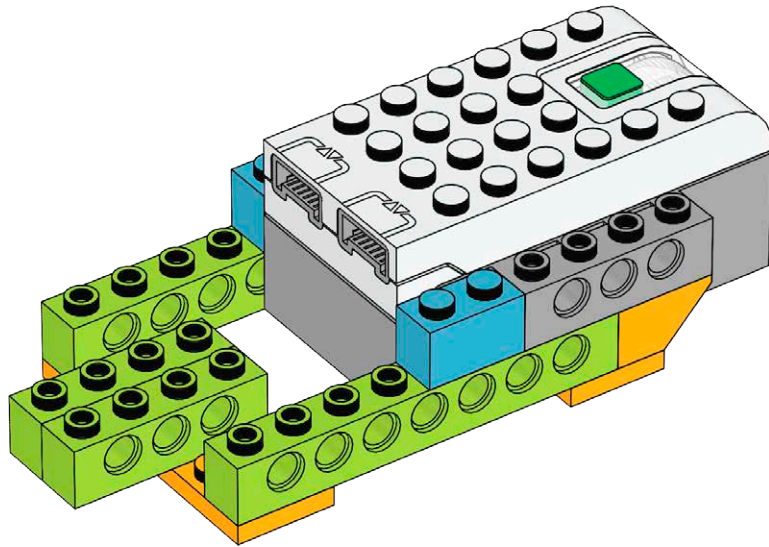

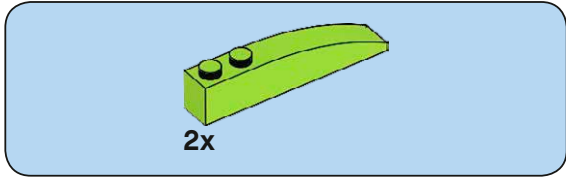

7

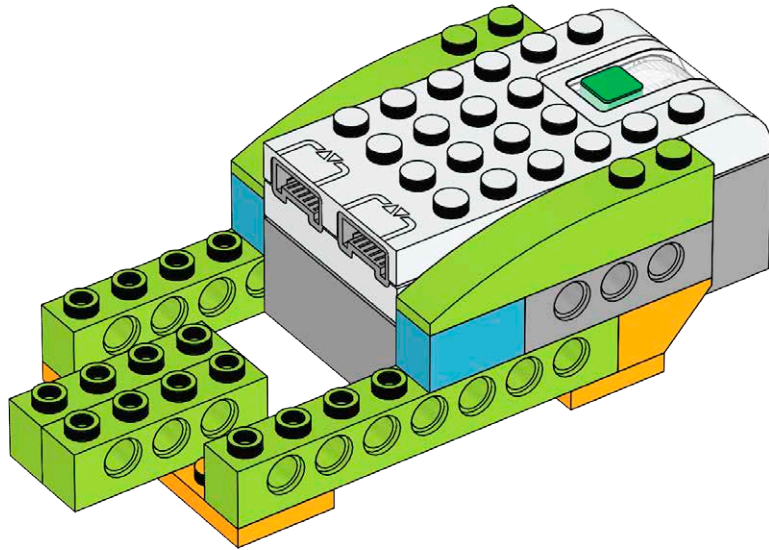

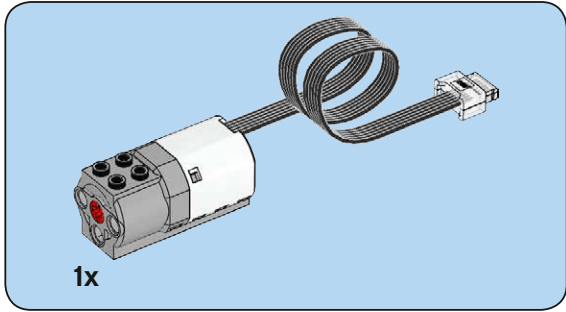

8

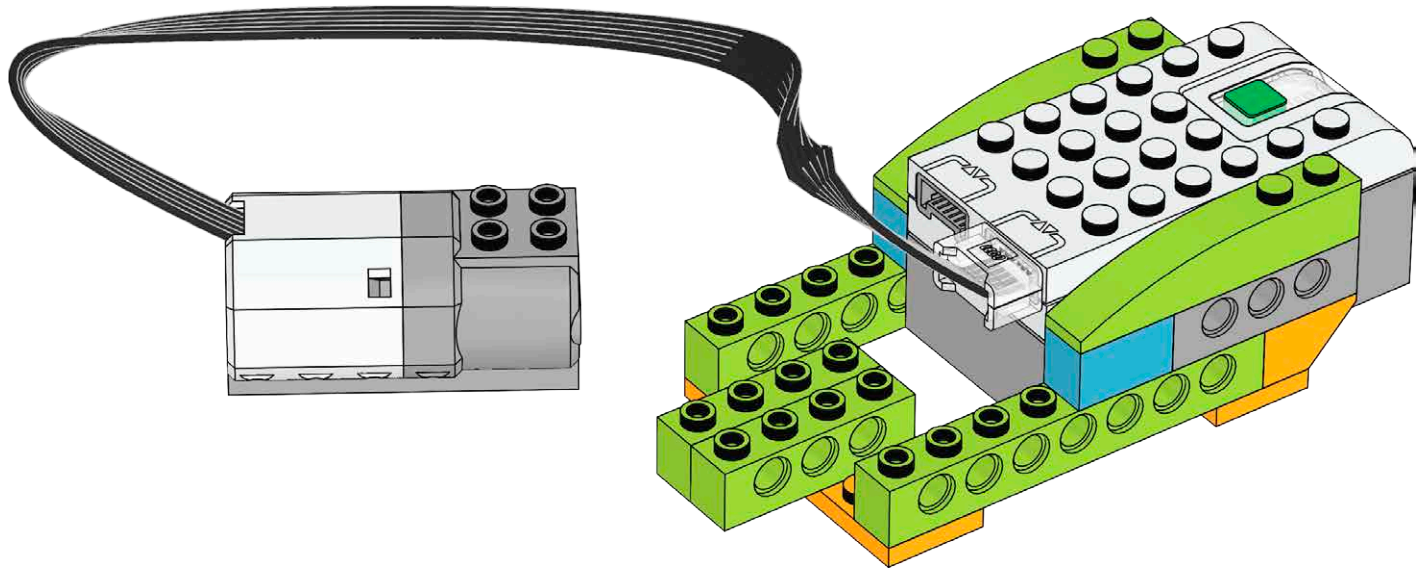

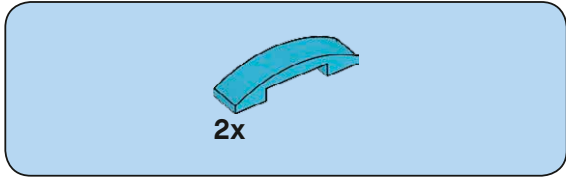

9

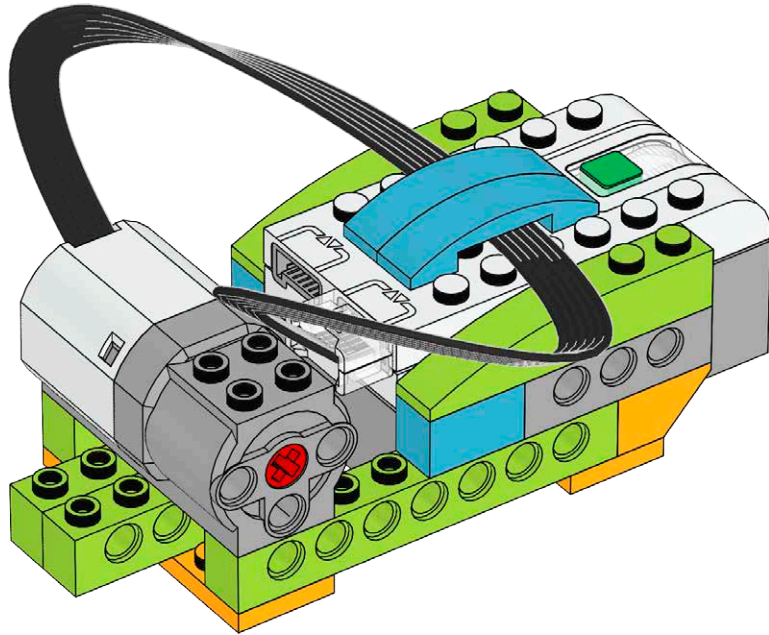

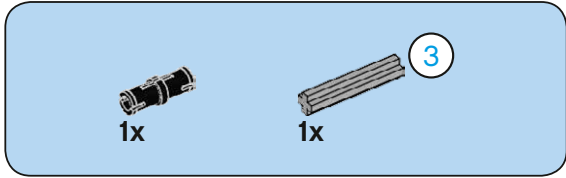

10

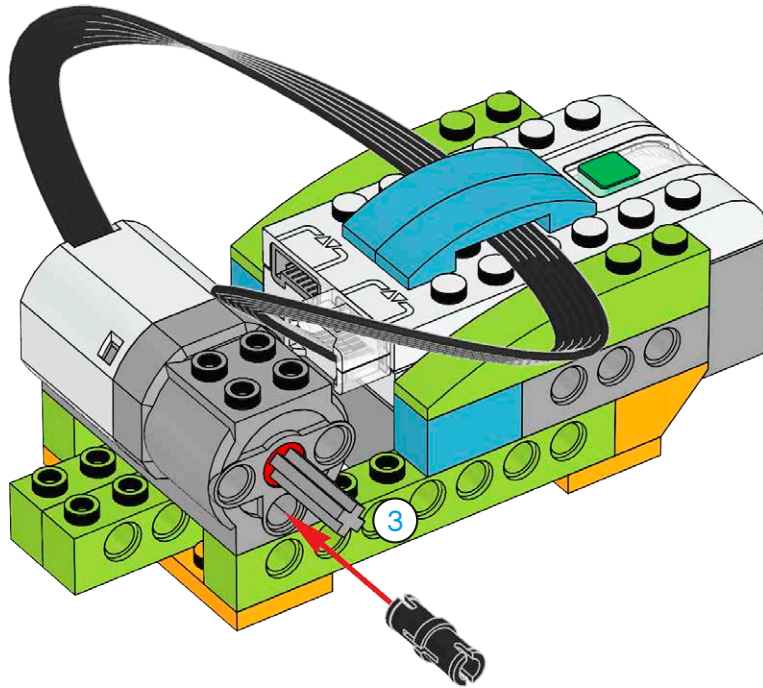

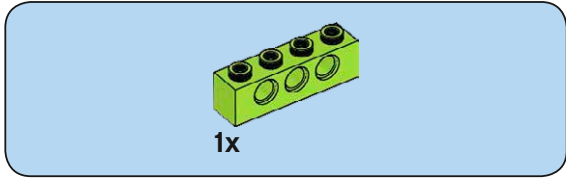

11

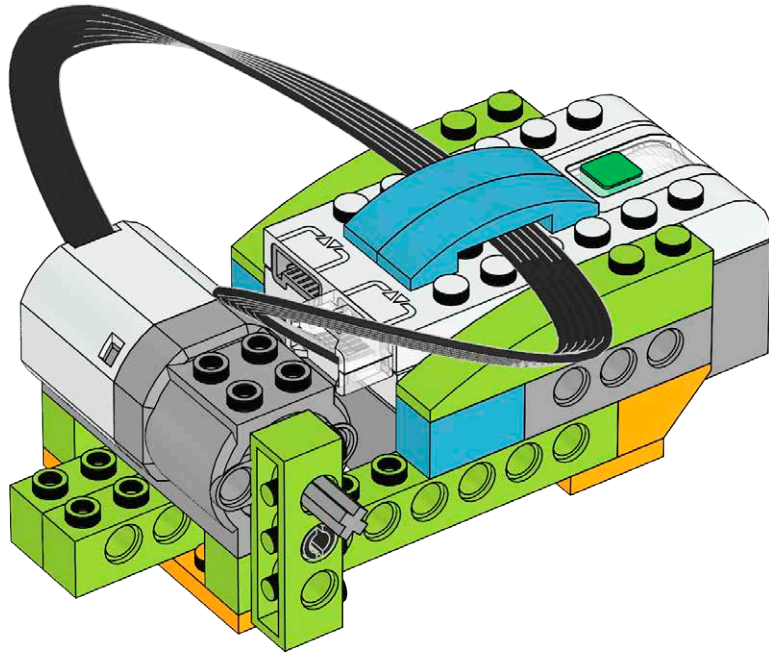

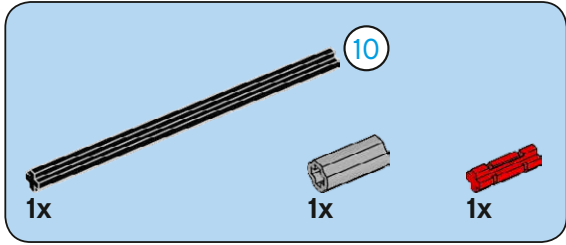

12

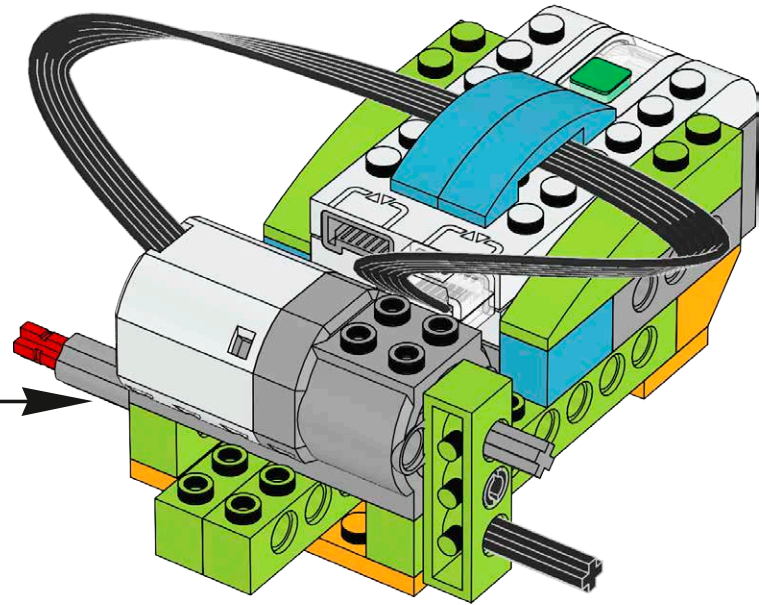
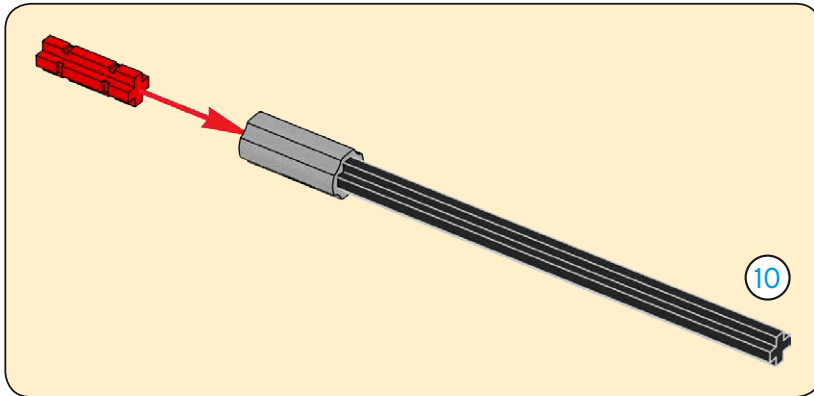

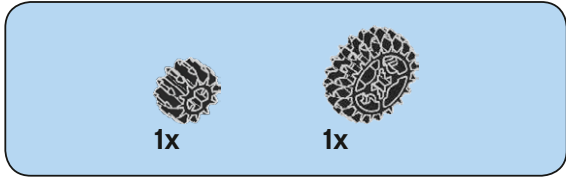

13

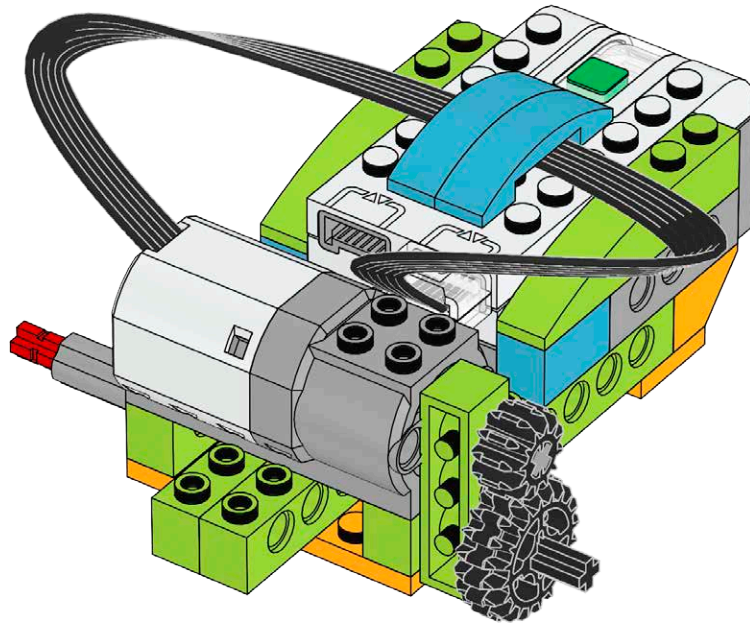

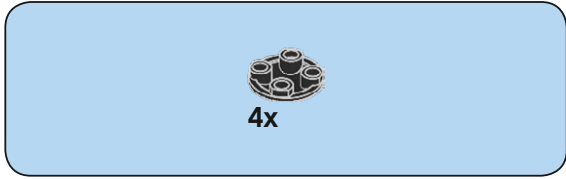

14

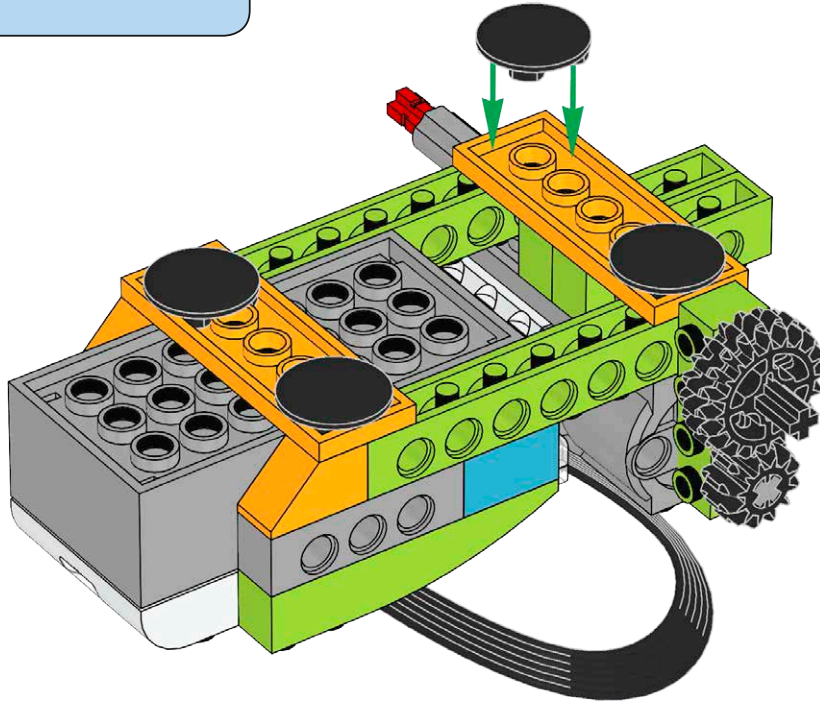

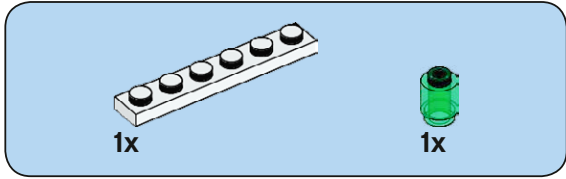

15

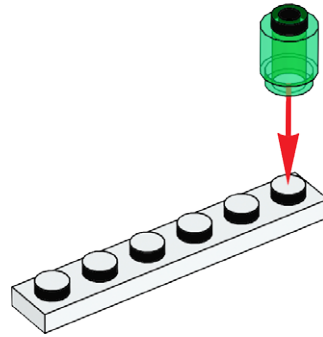

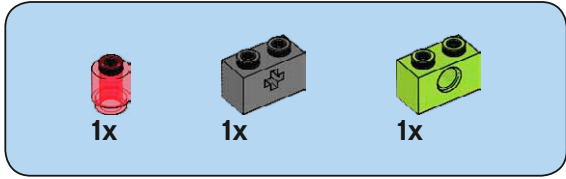

16

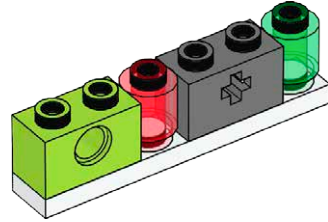

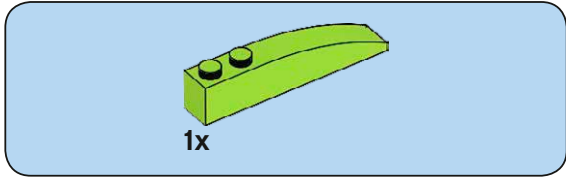

17

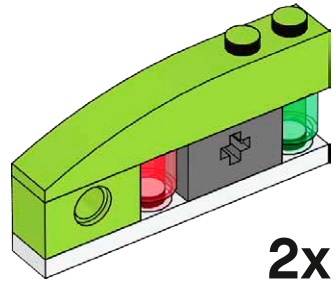

18

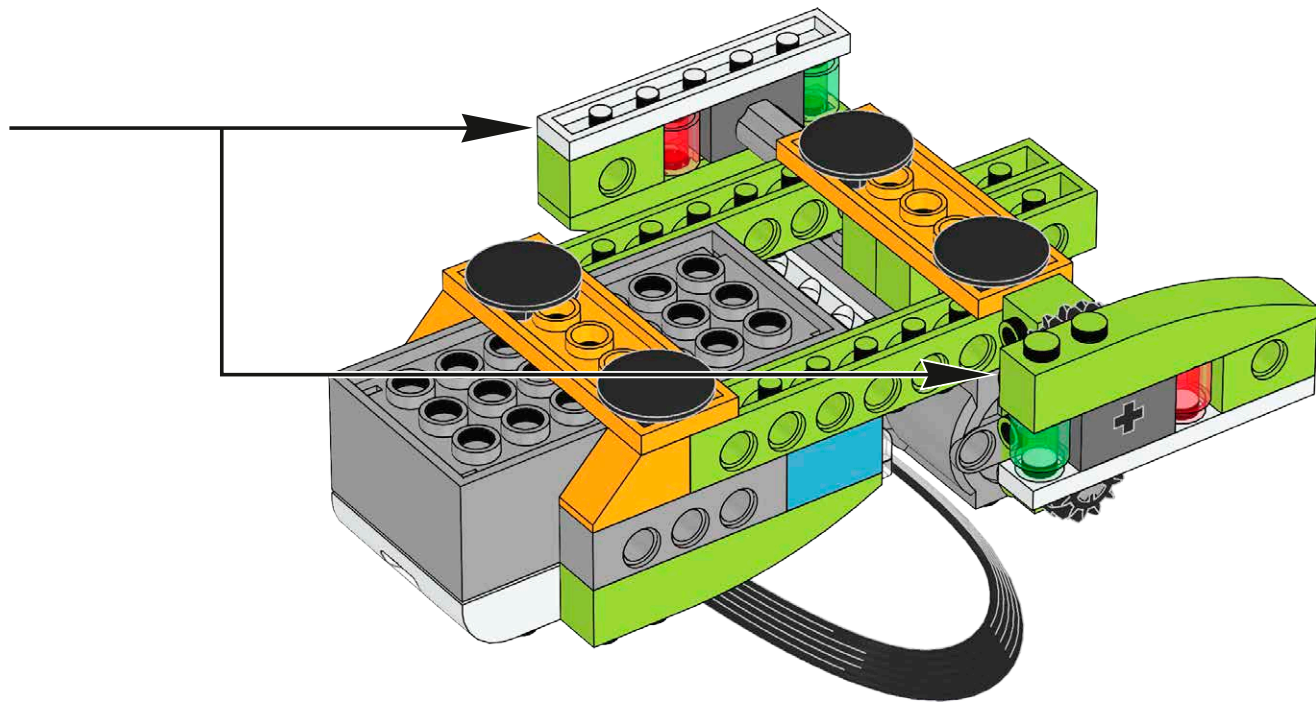

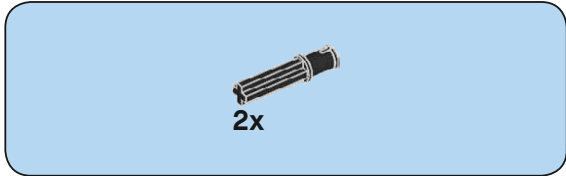

19

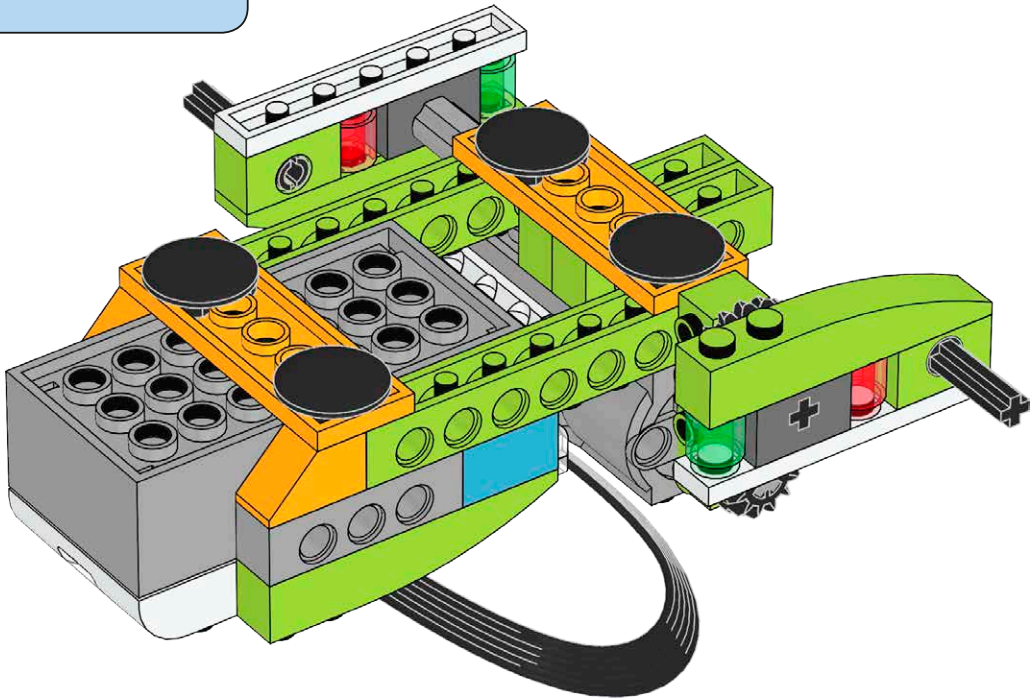

20

