

# CV1

# Sport motor boat

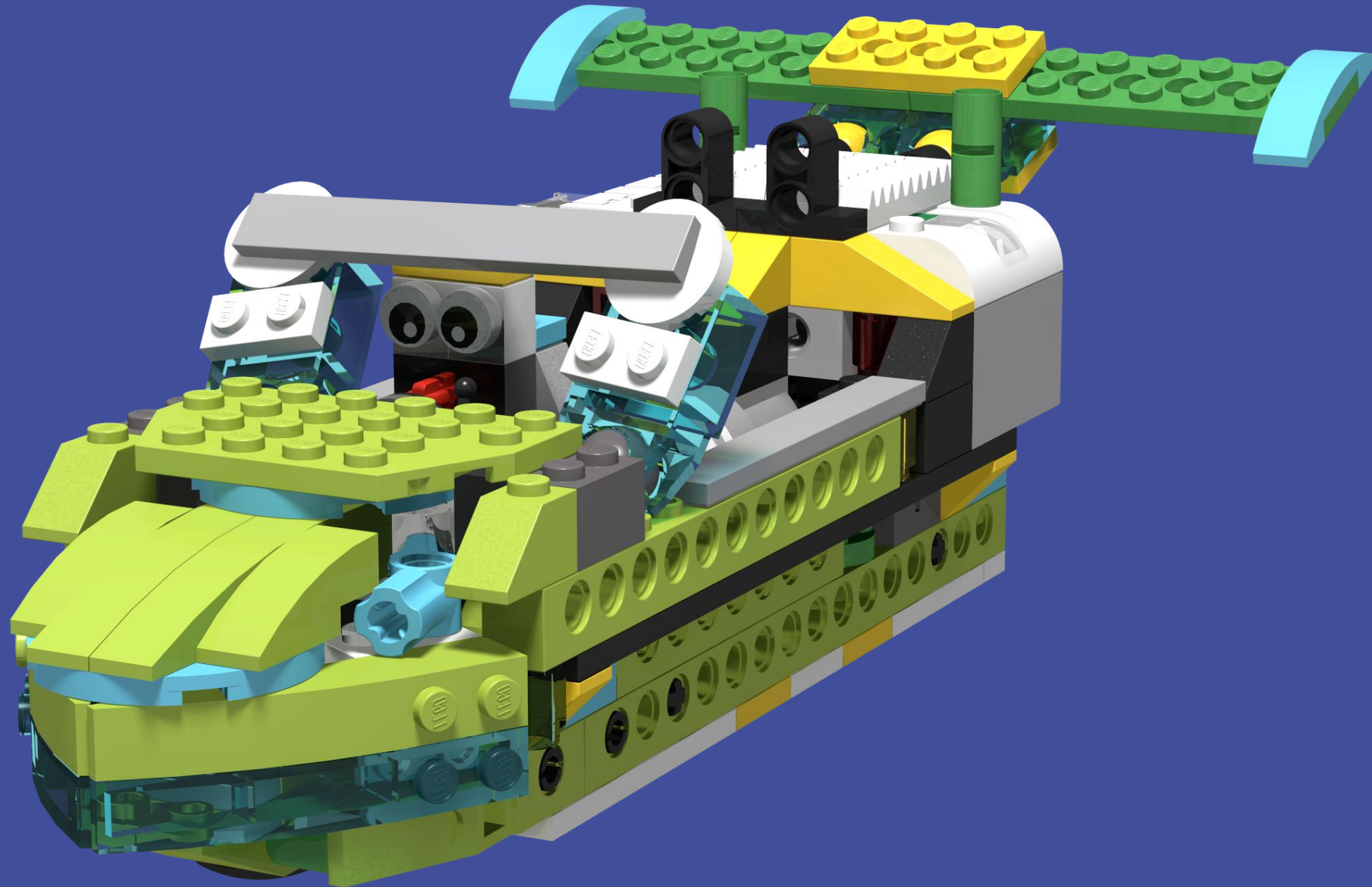

1

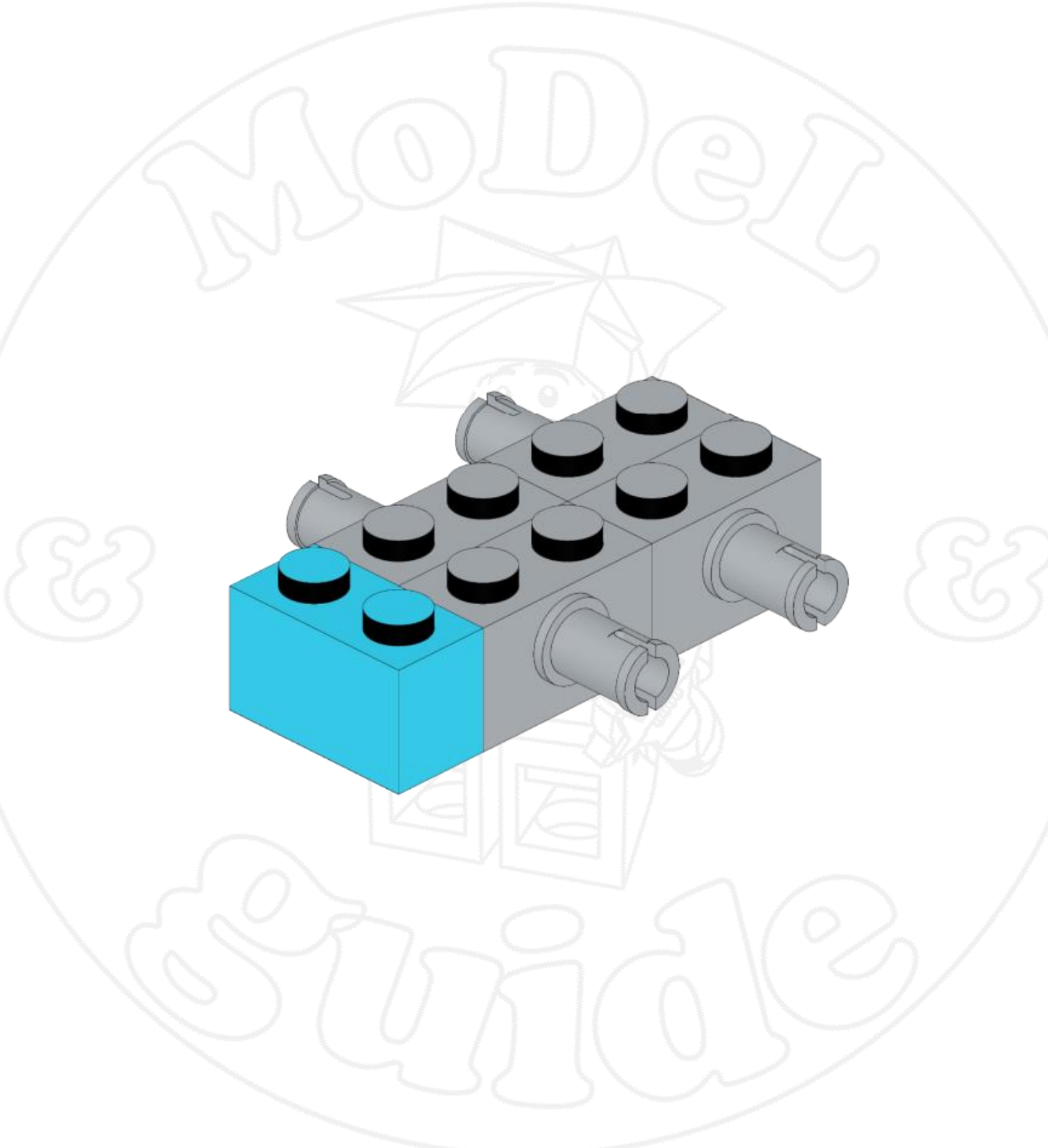
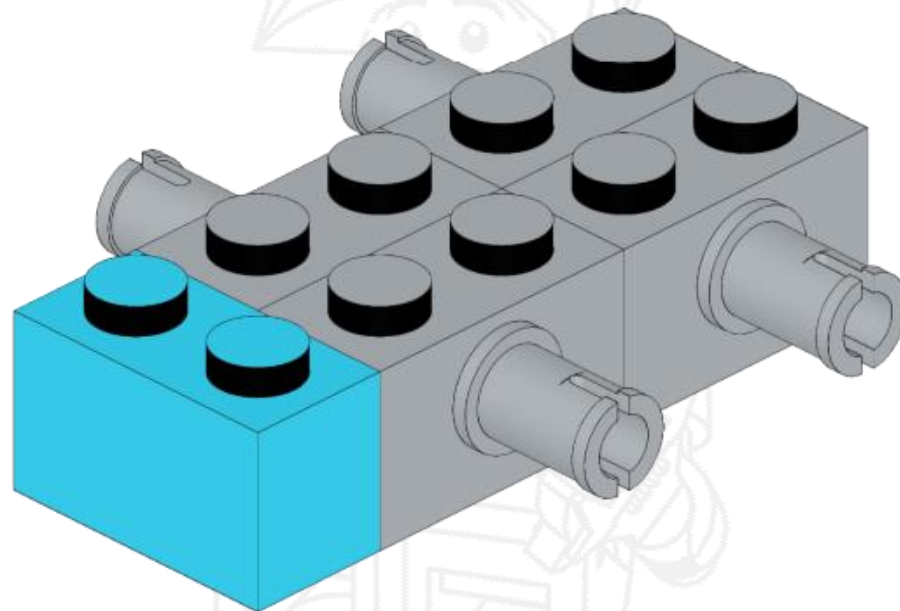
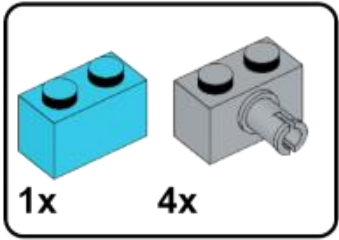

2

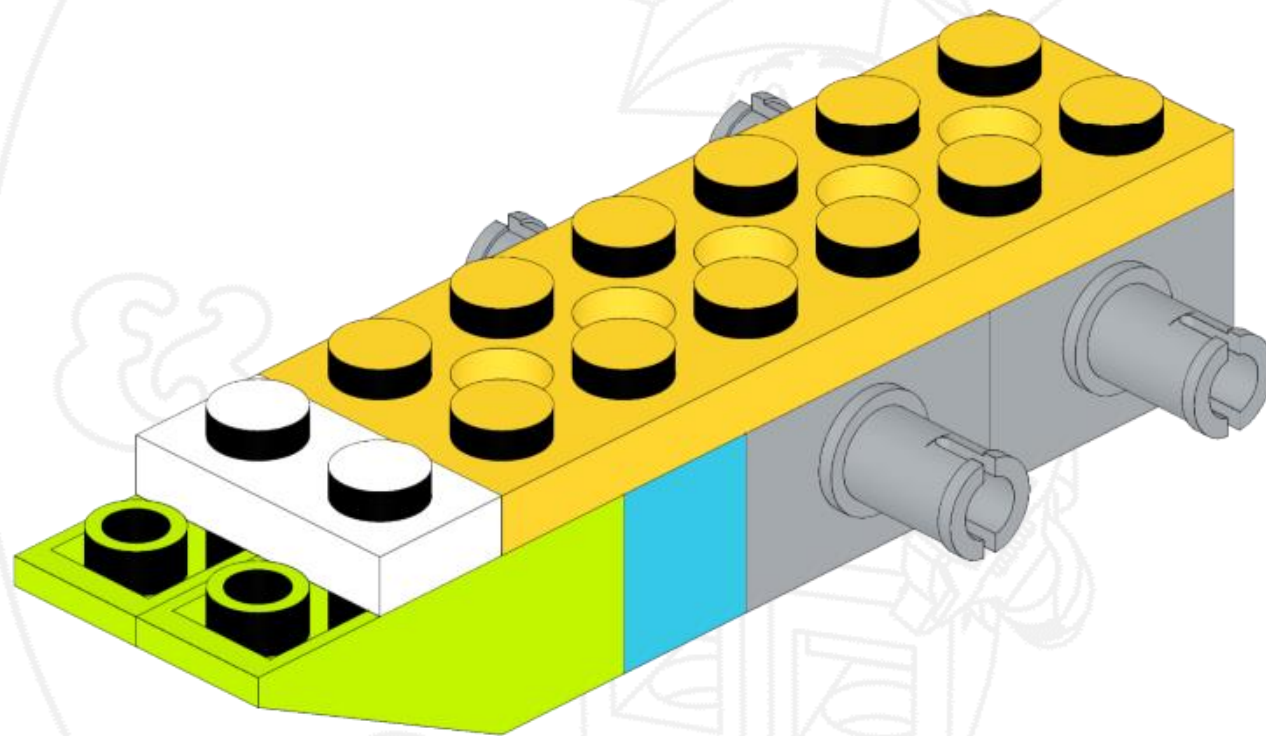
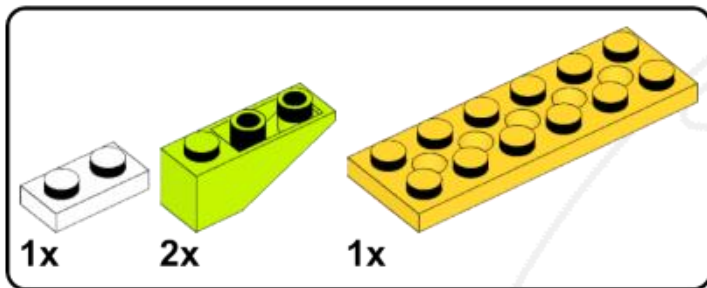

3

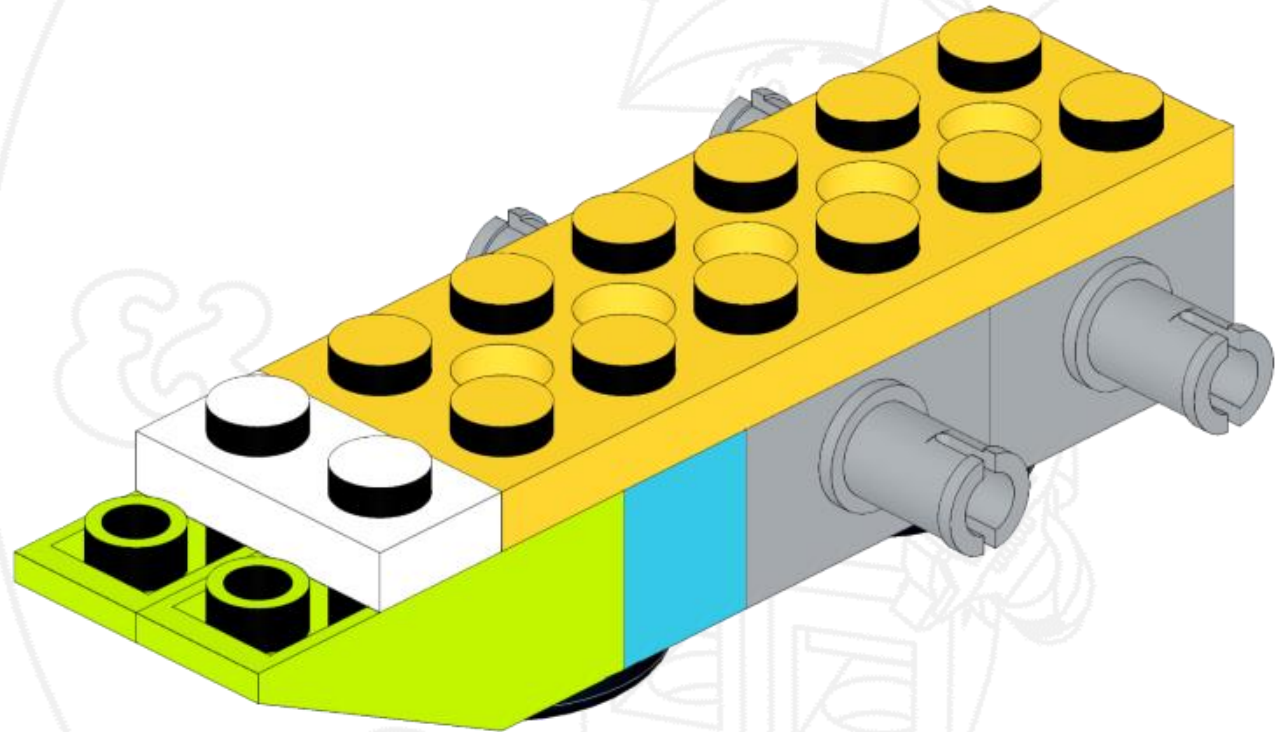

Model

guide

4

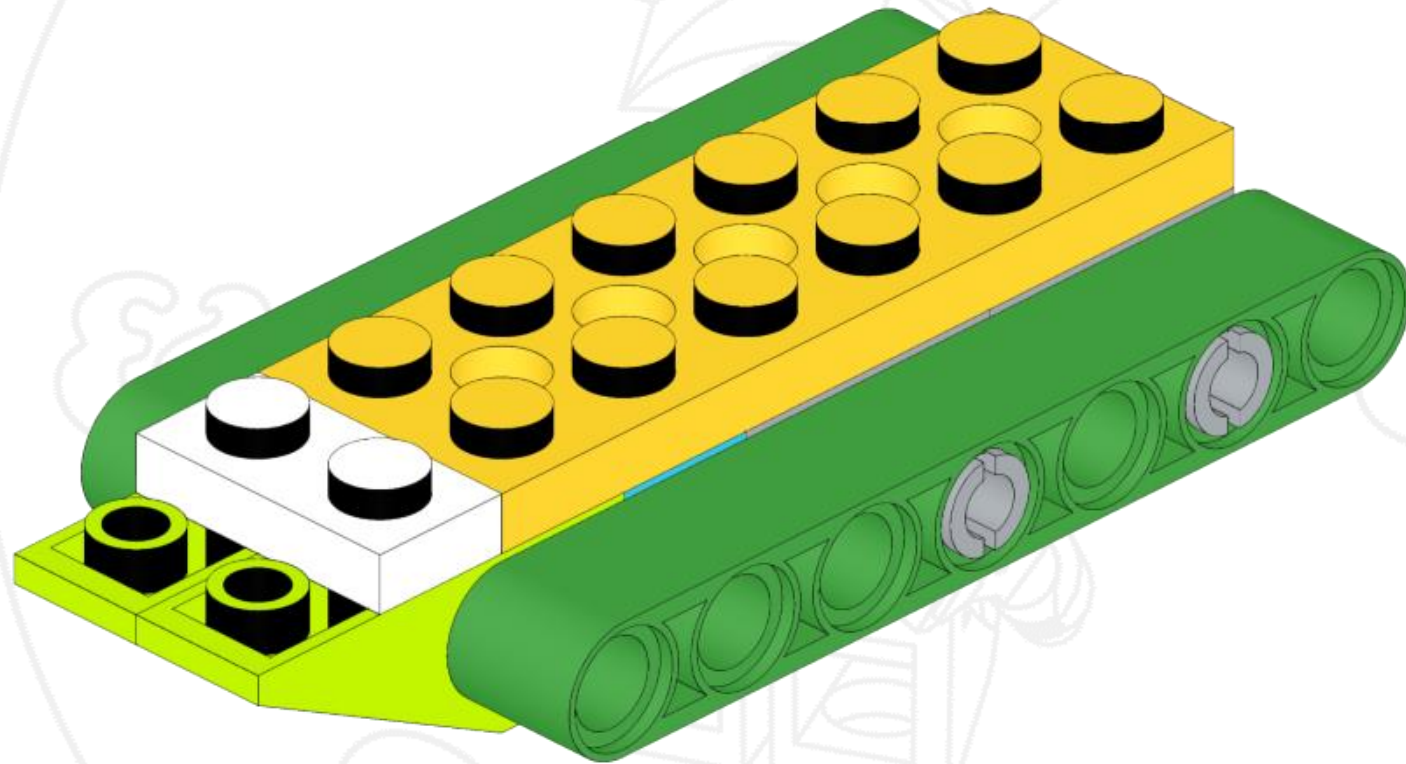
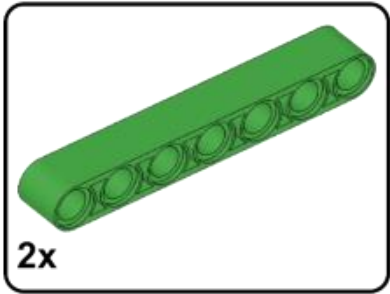

Model

Guide

5

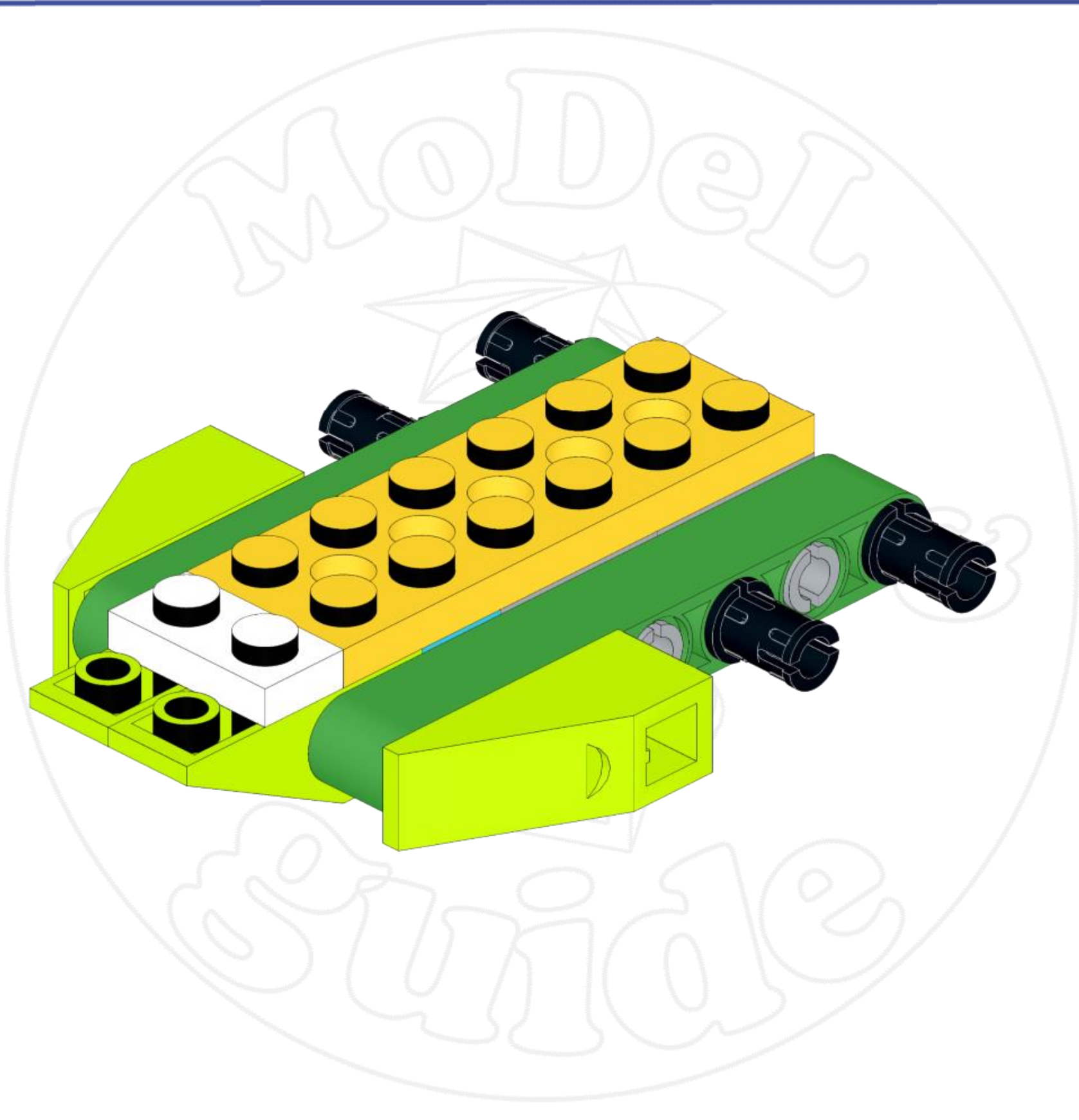
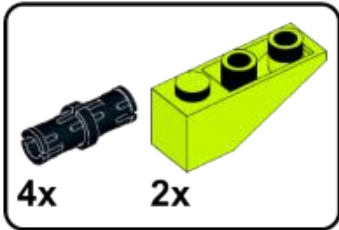

6

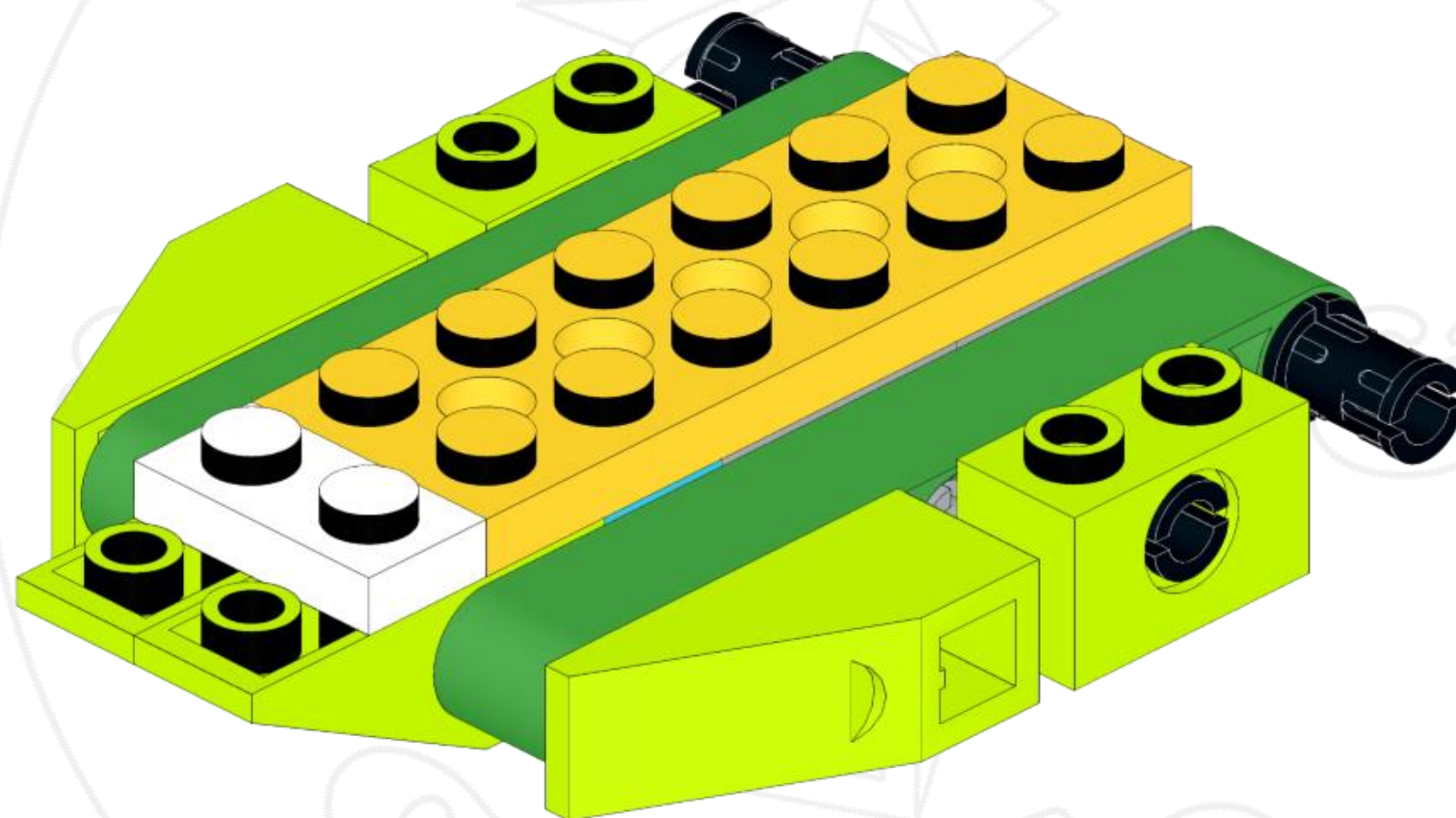
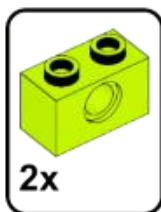

MoDeL

guide

7

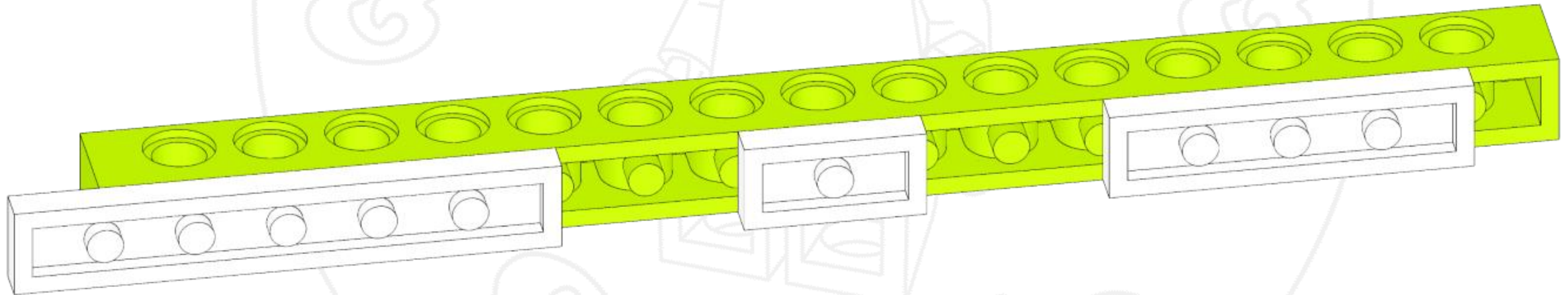
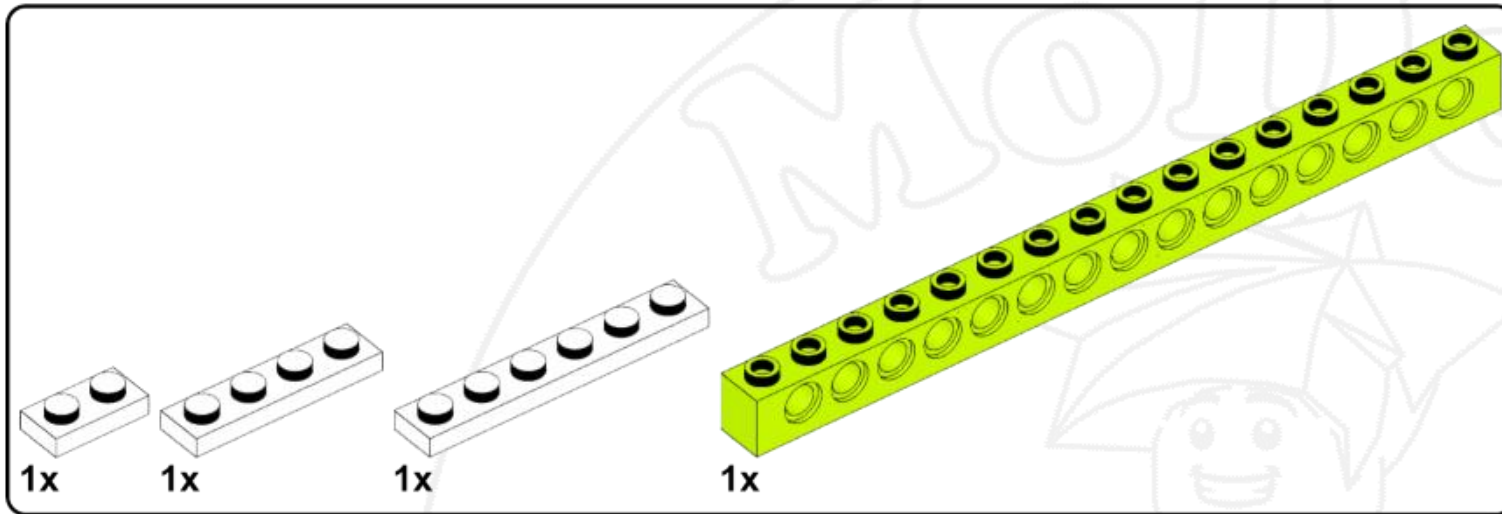



8

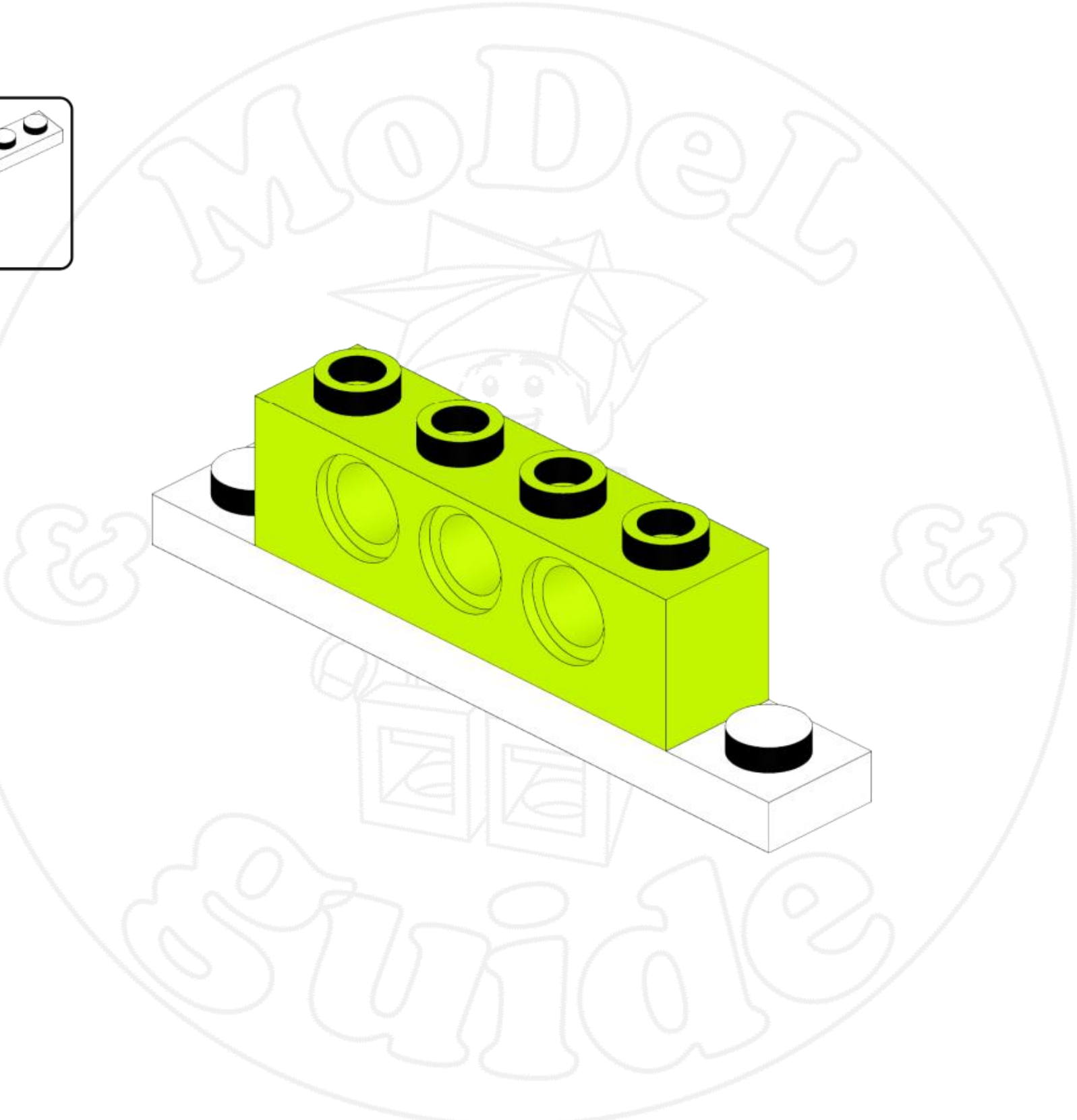
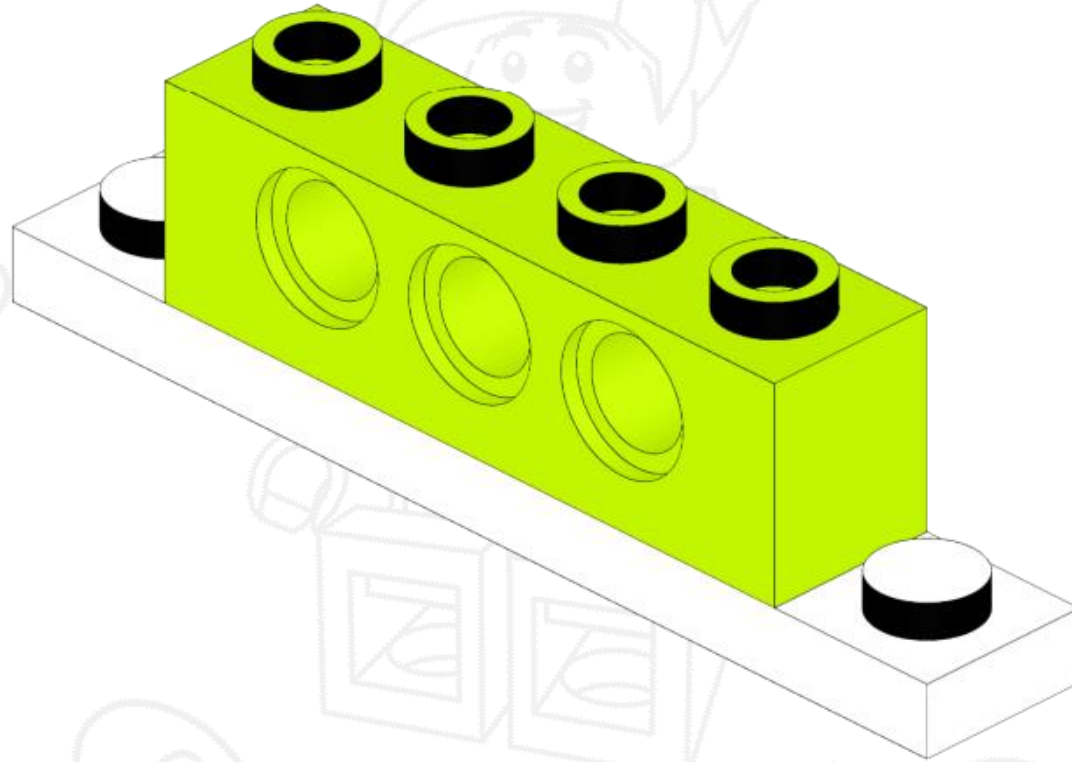
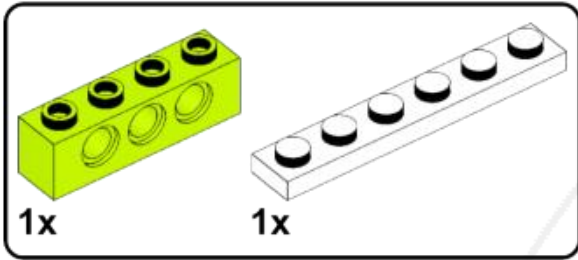

9

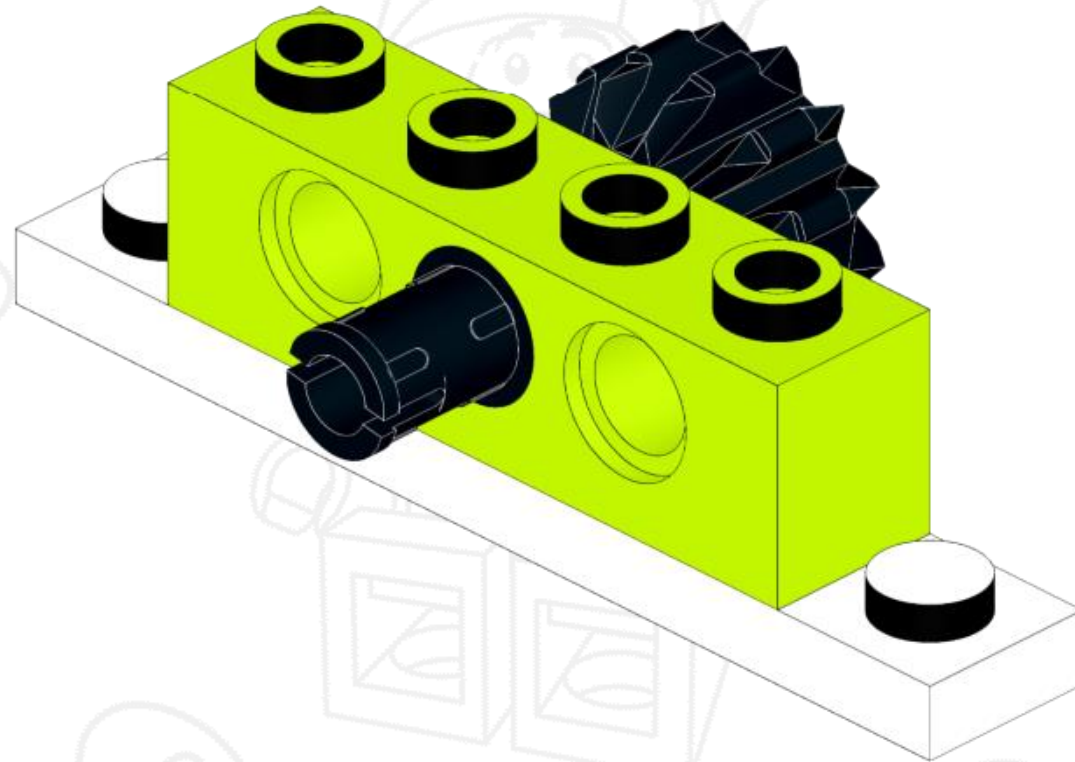
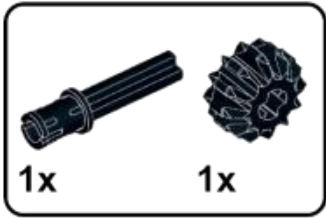

10

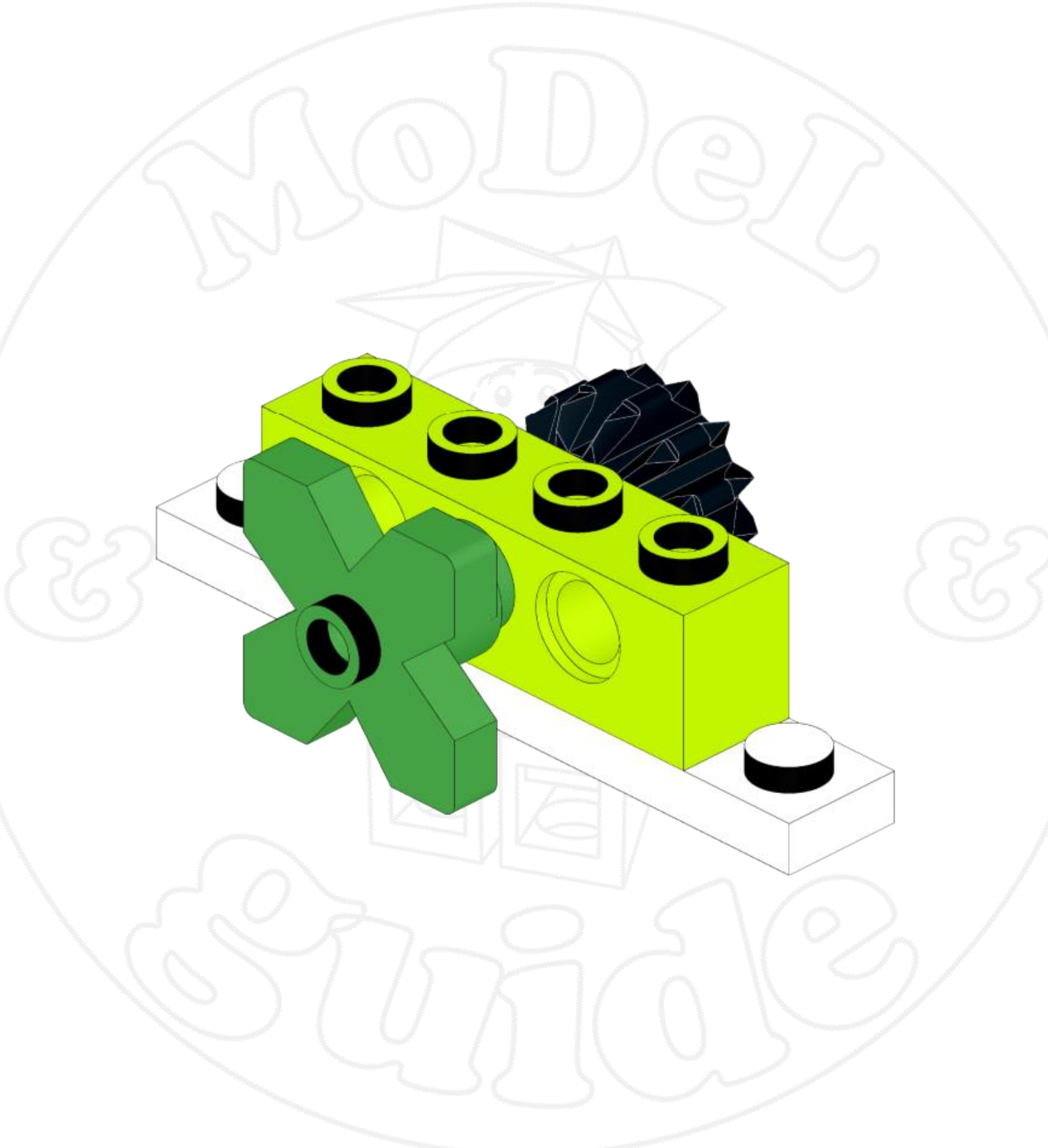
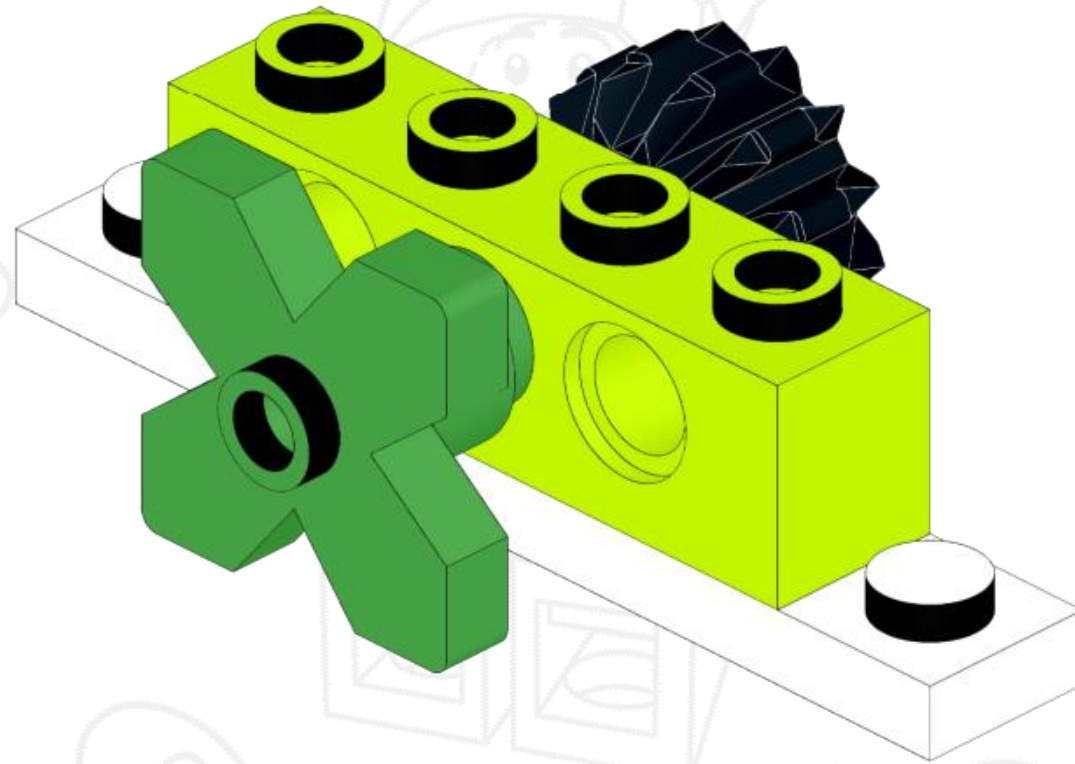
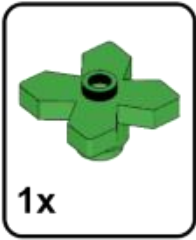

11

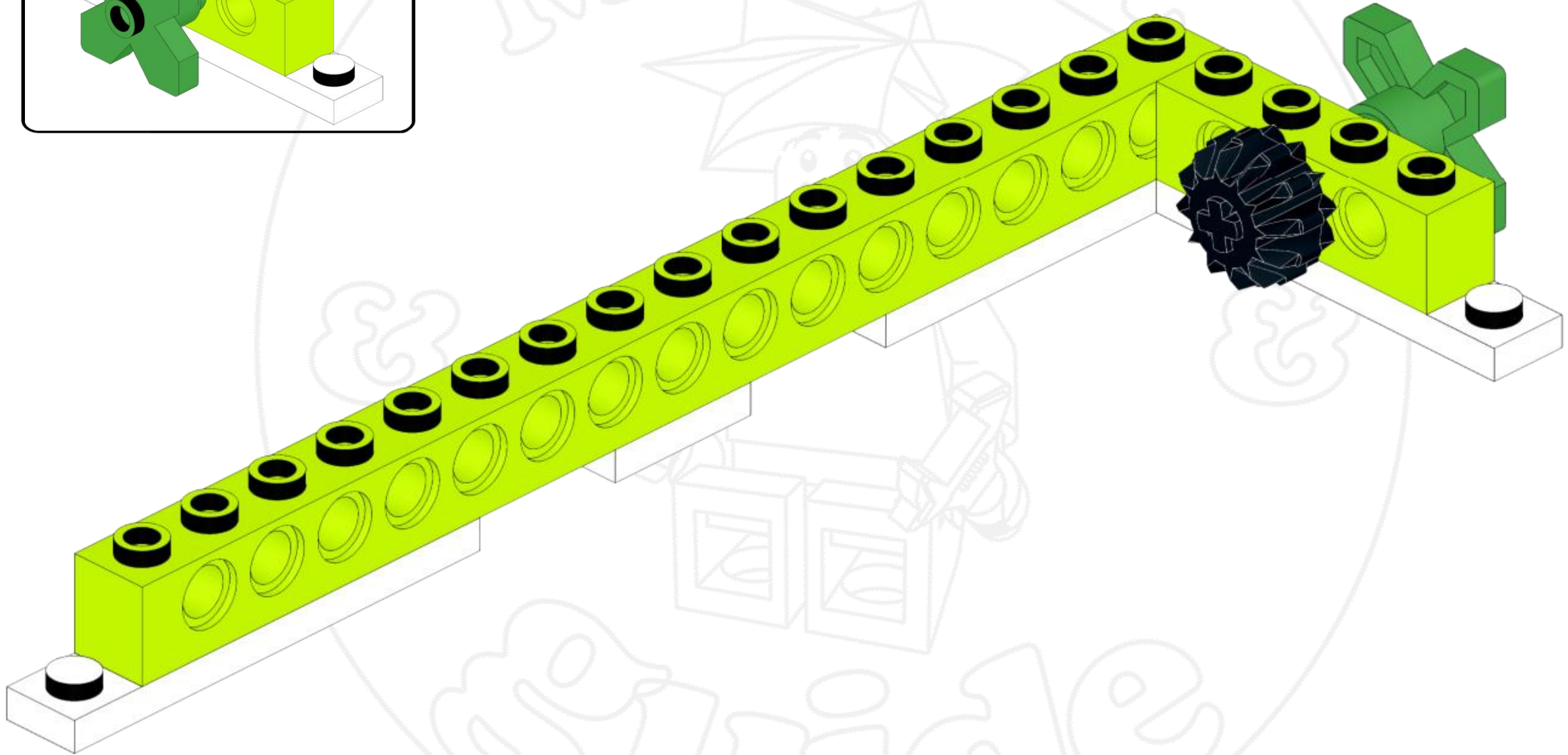
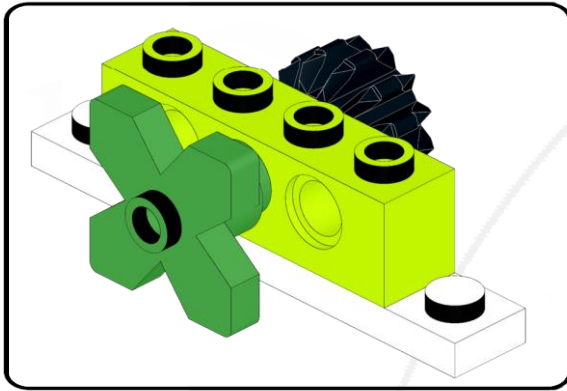

Modeller  
&  
Builder's  
Guide

12

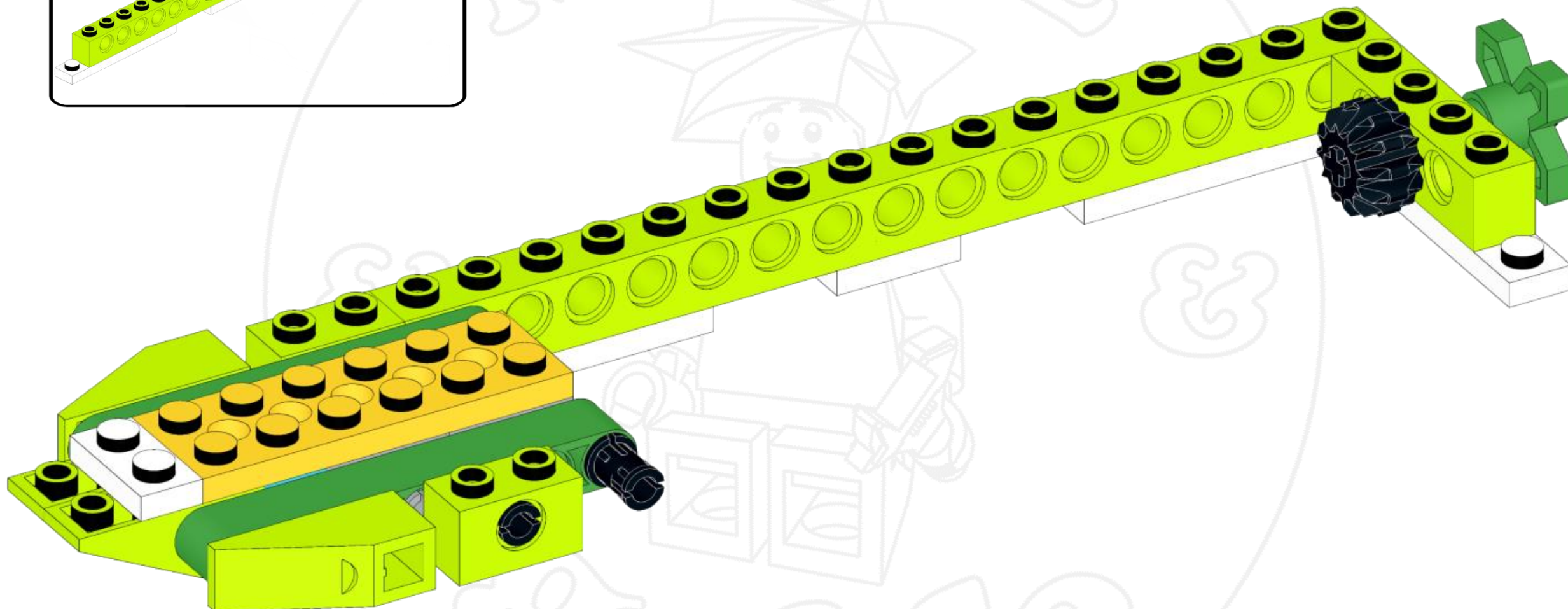
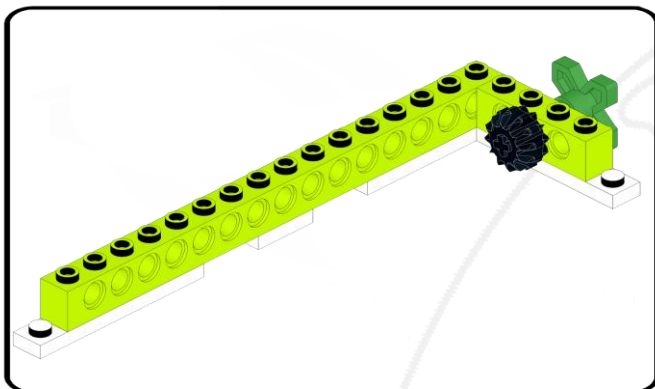

13

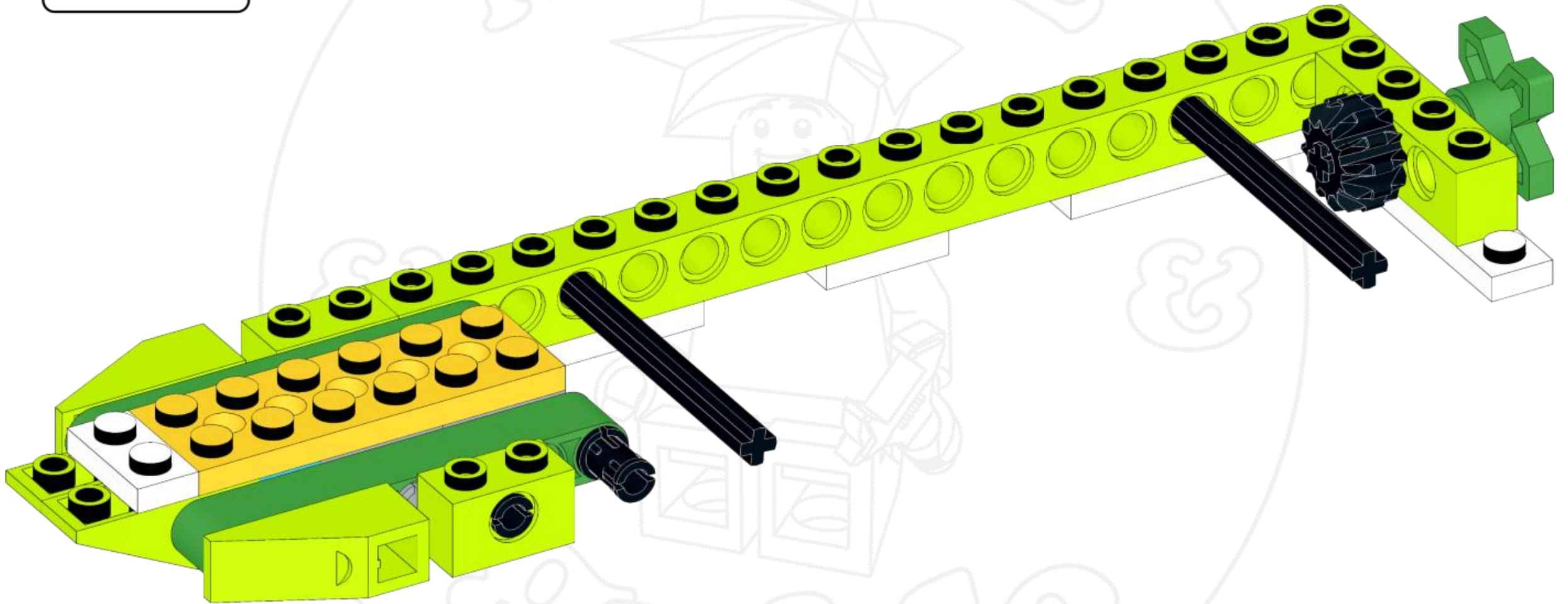
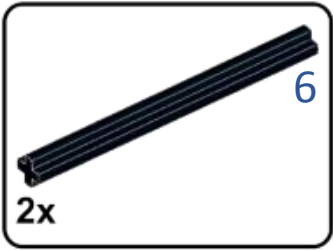

14

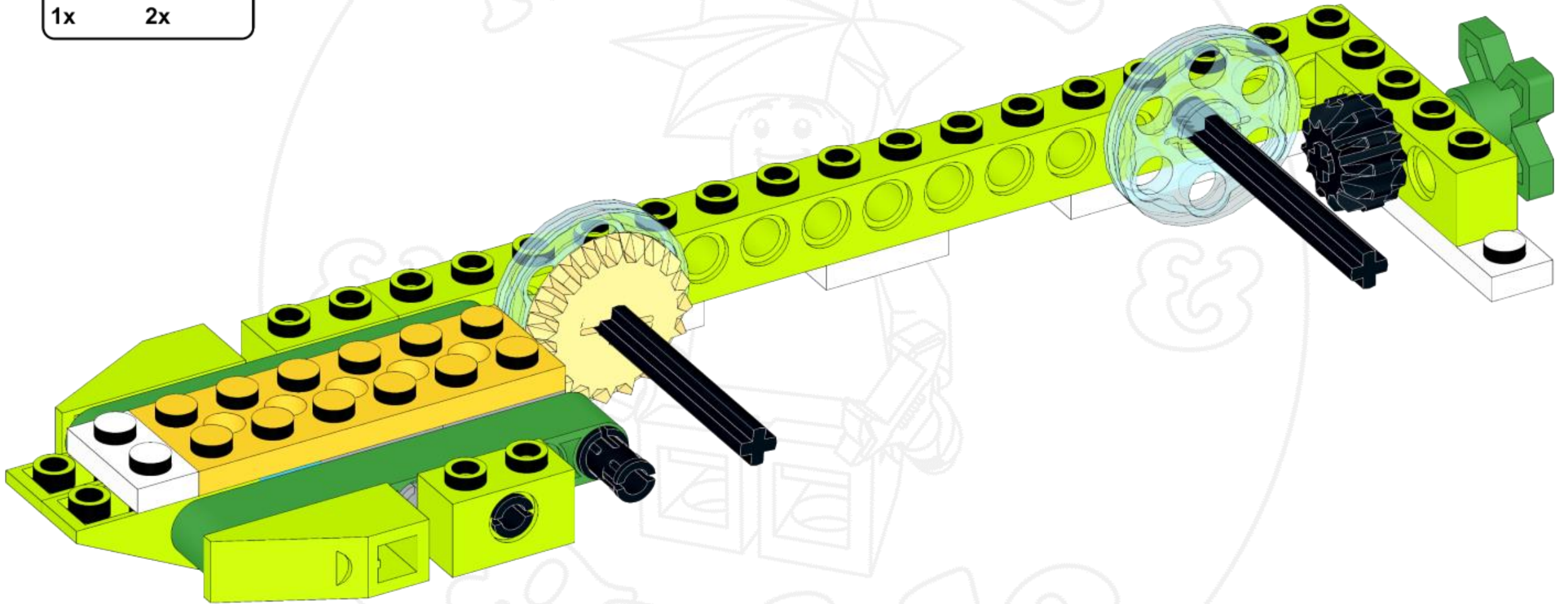
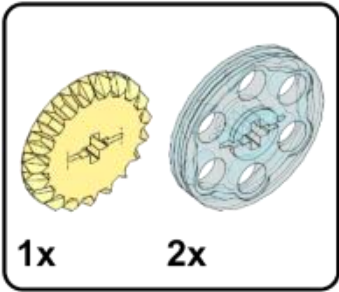

15

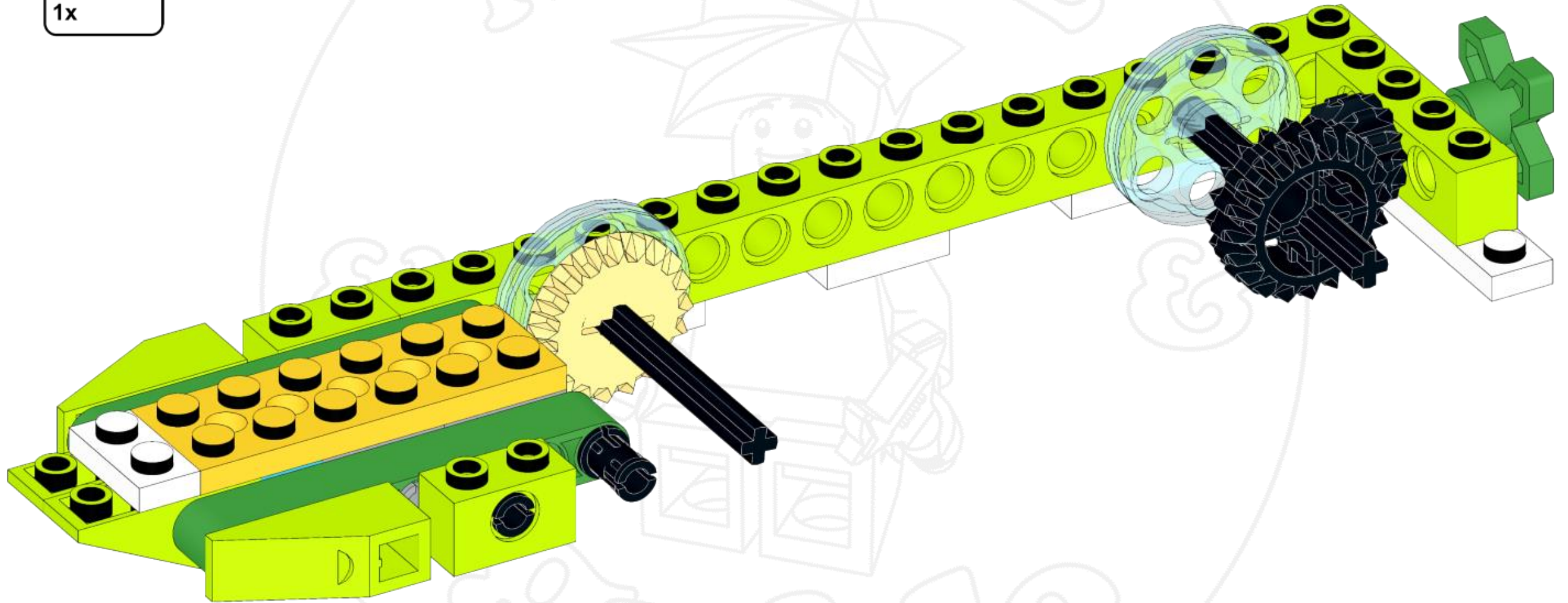



16

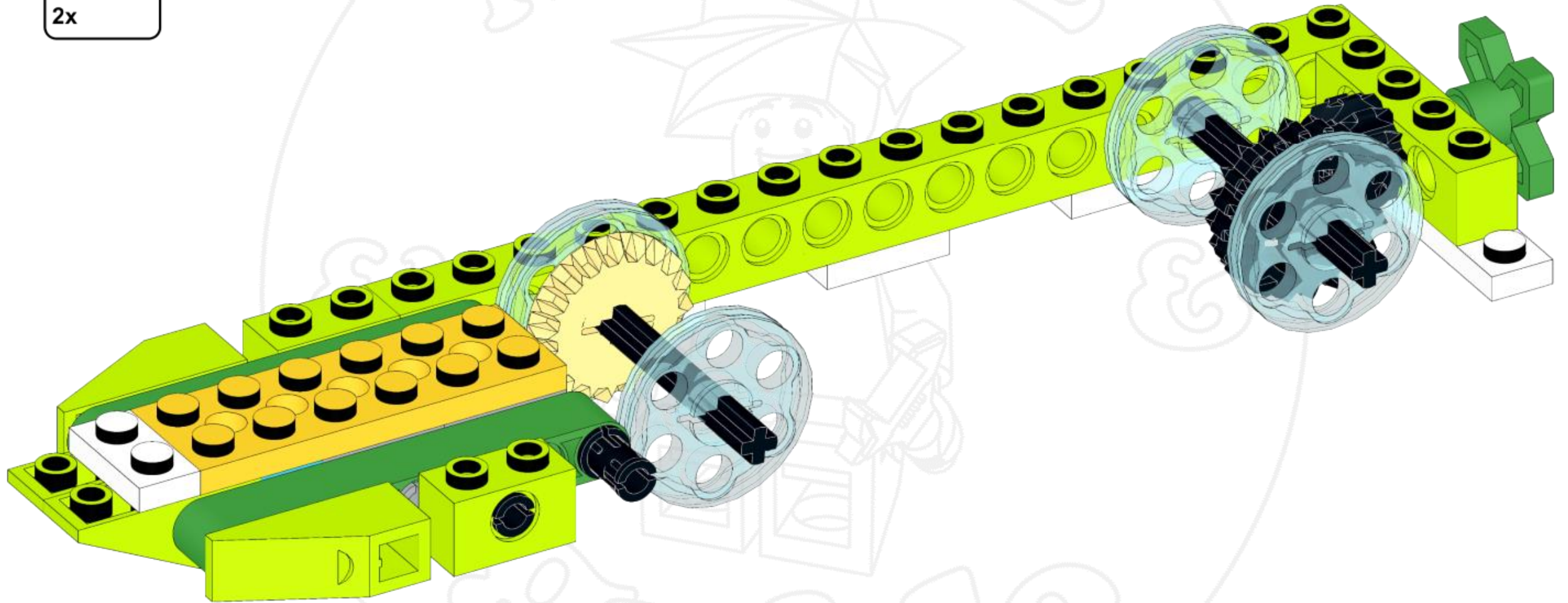
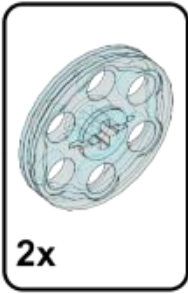

17

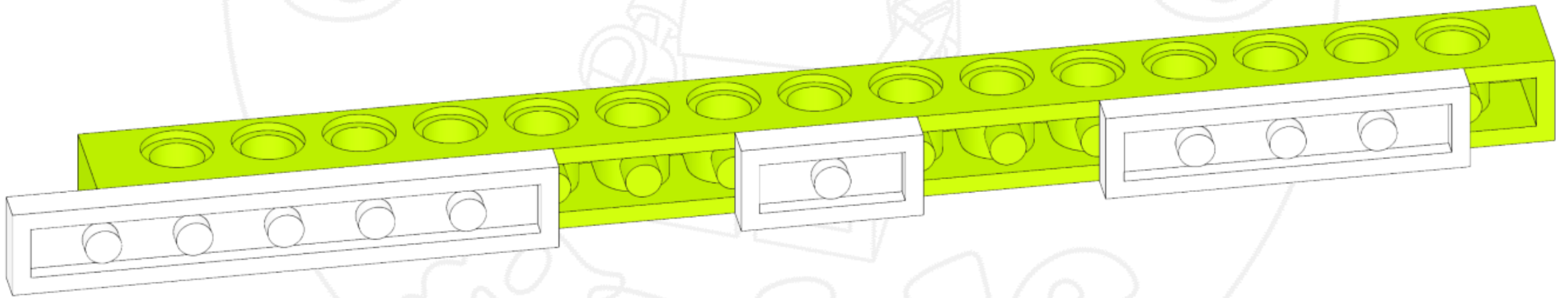
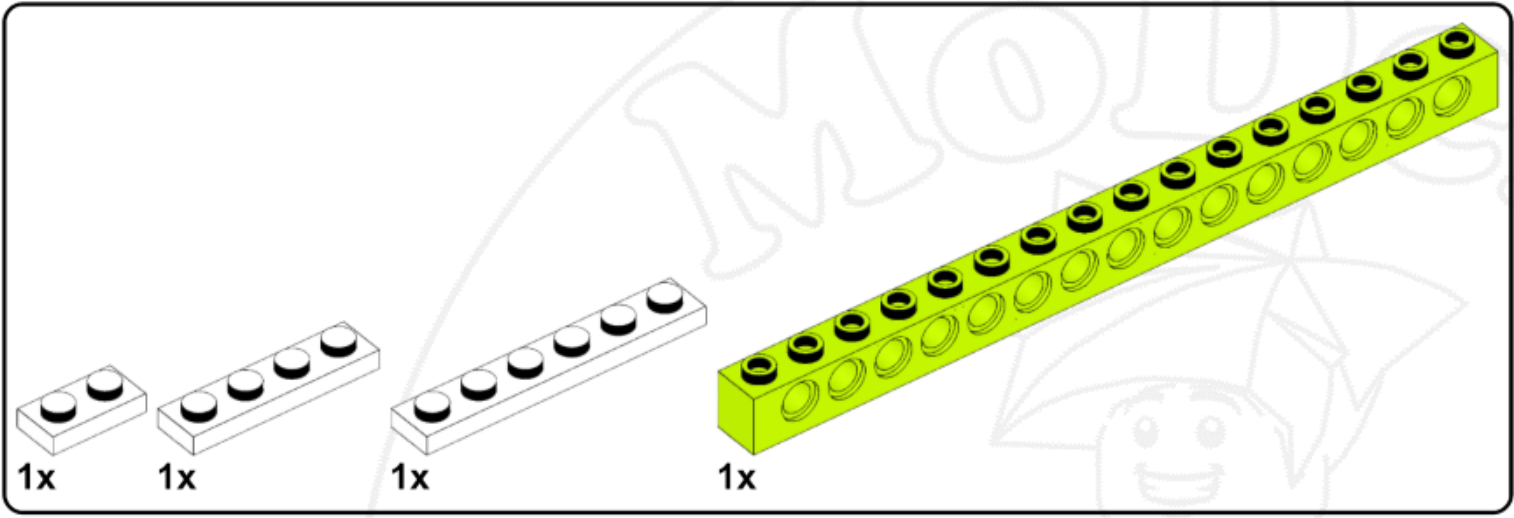

18

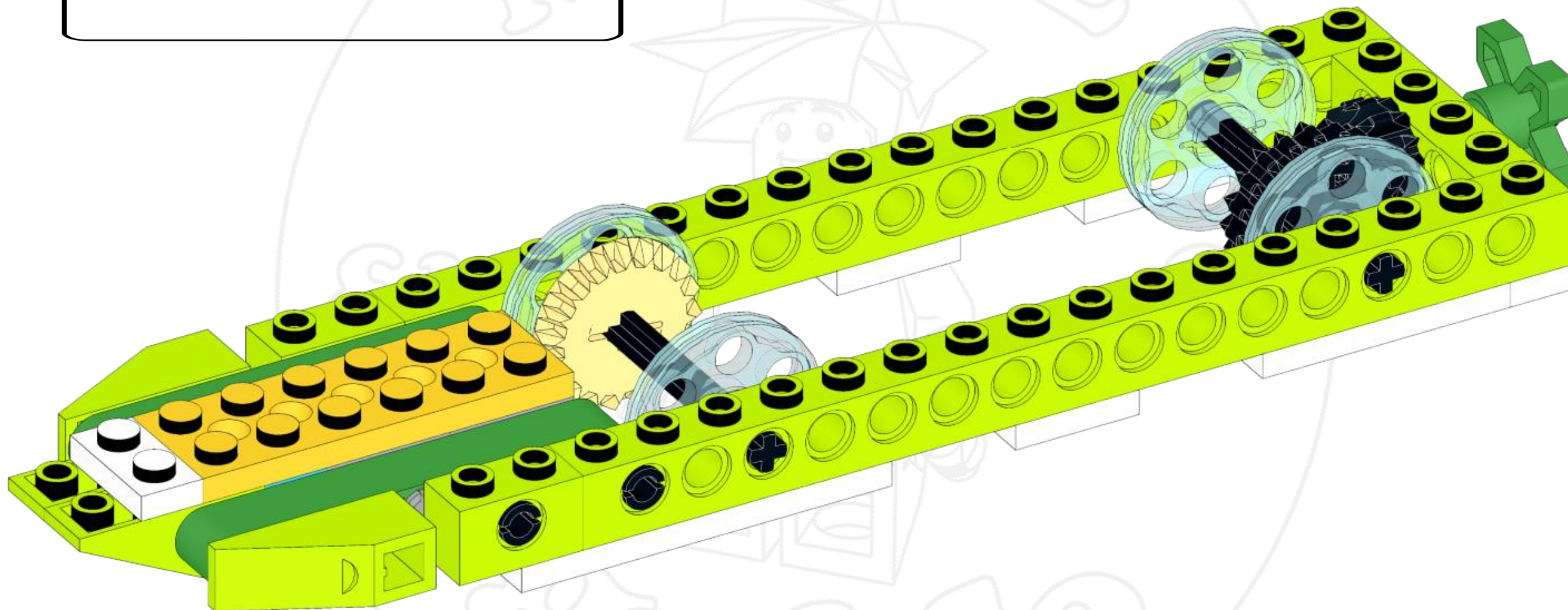
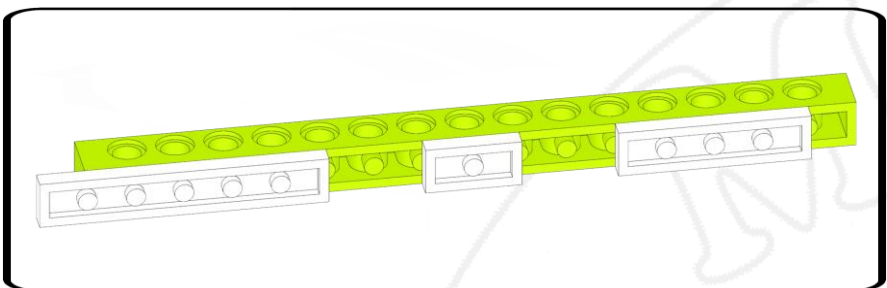

19

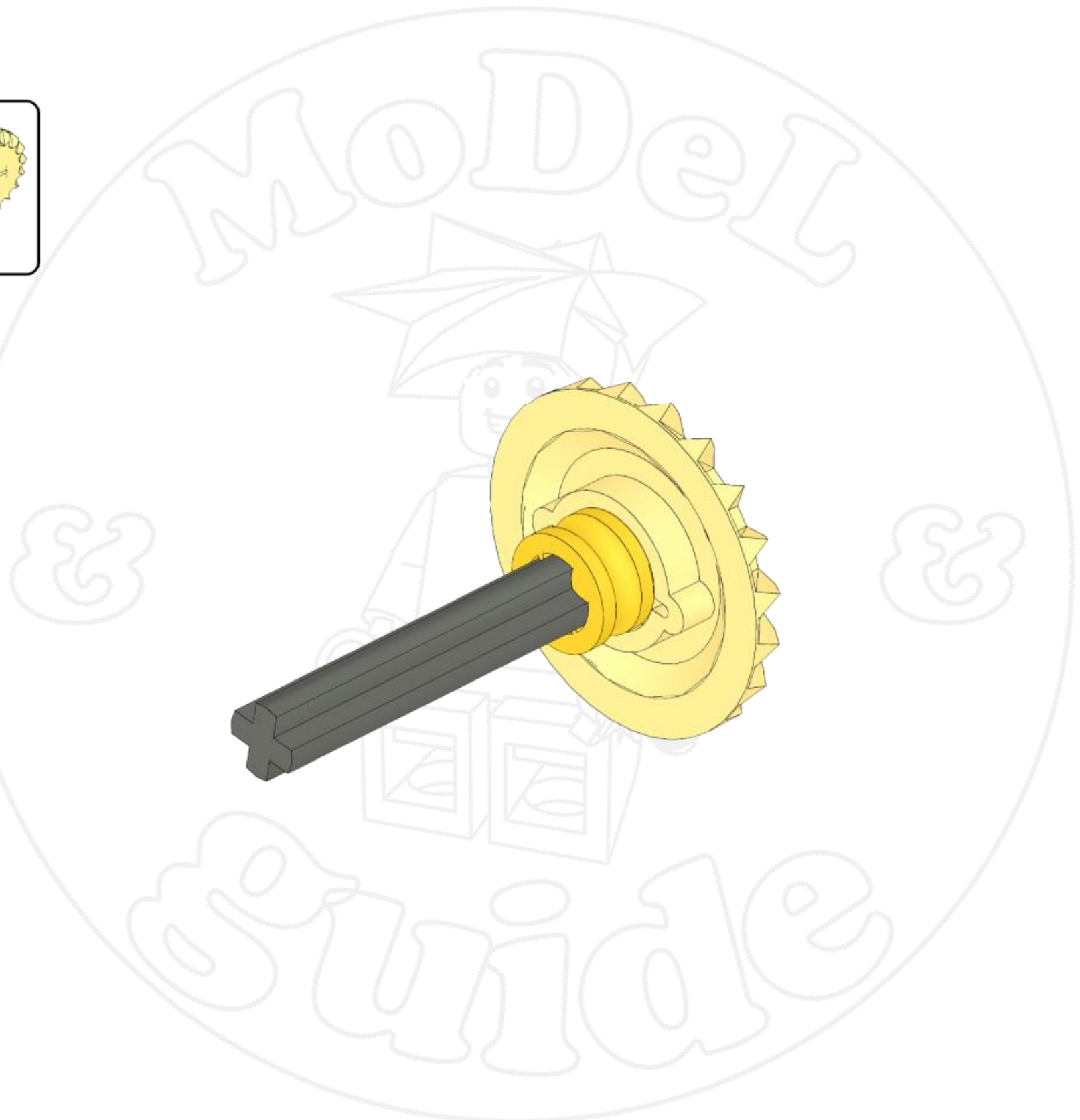
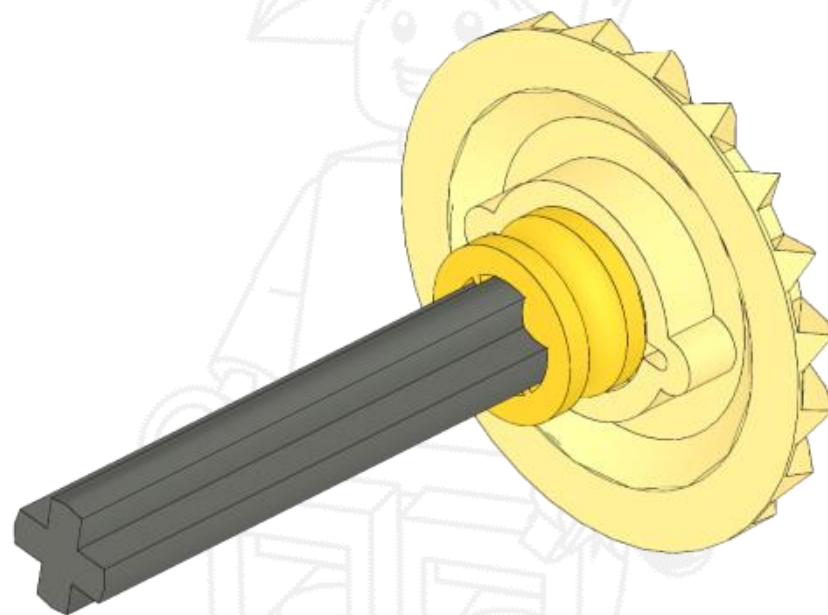
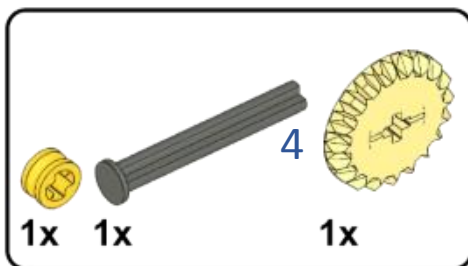

20

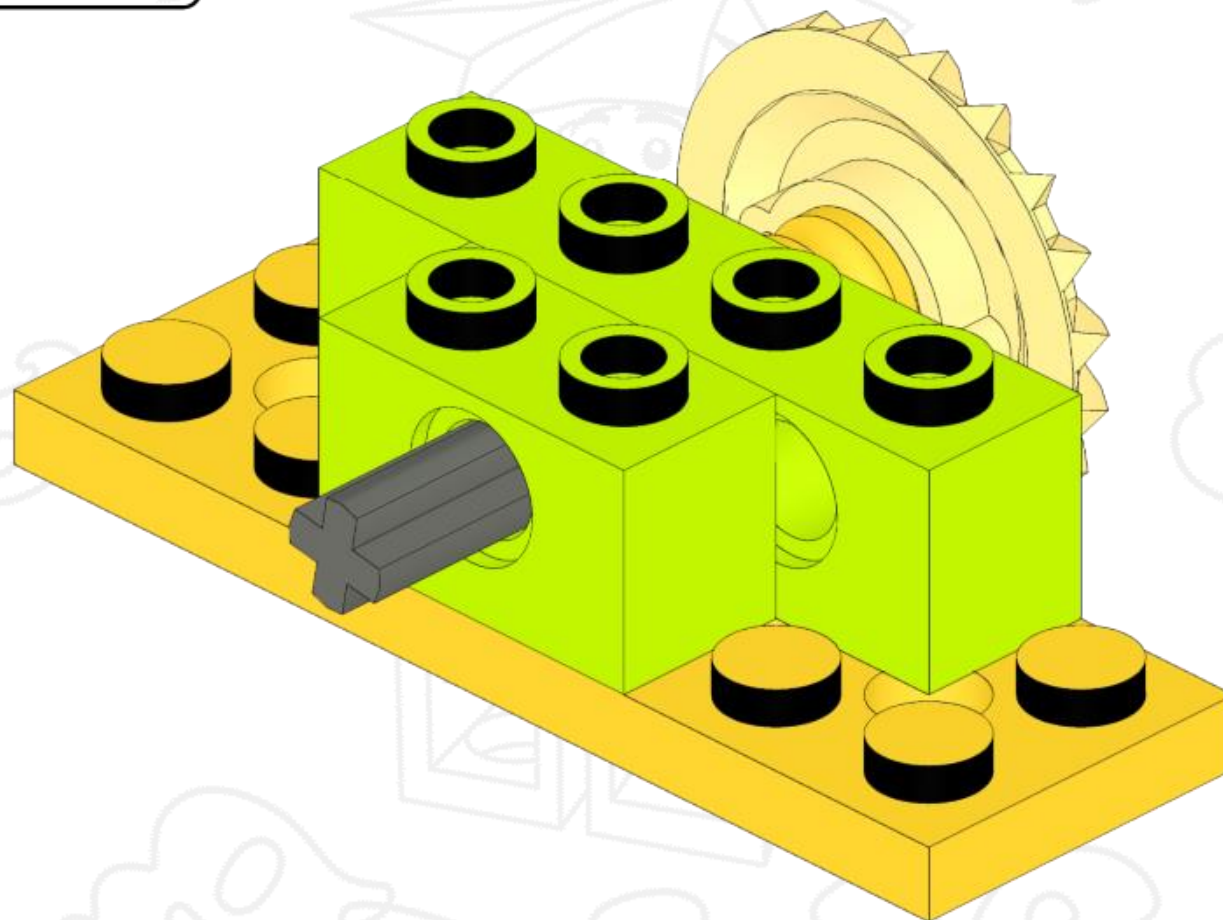
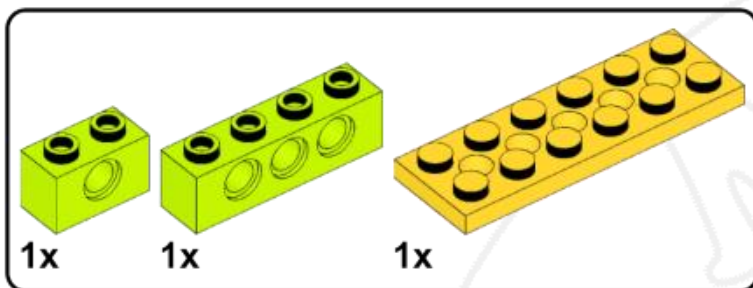

21

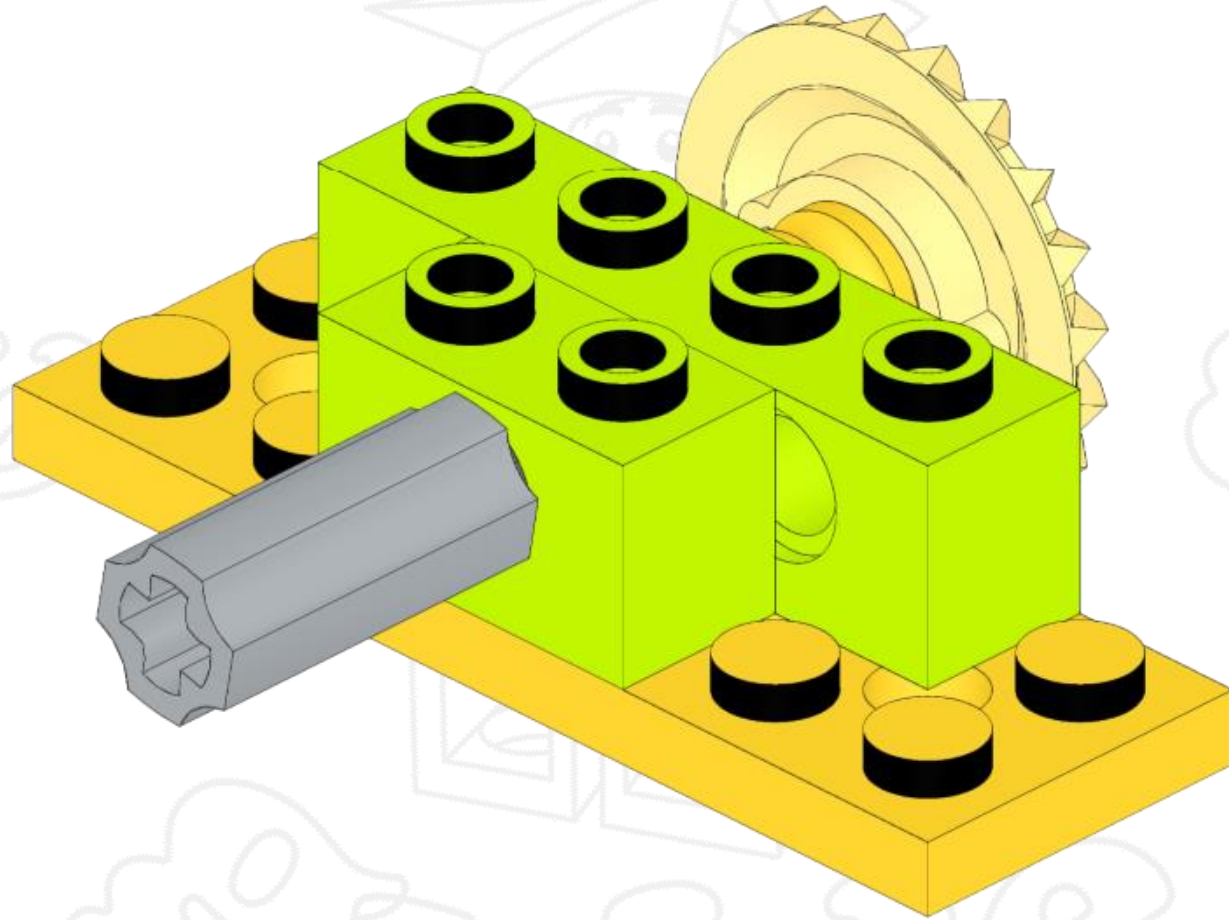
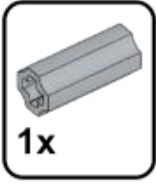

22

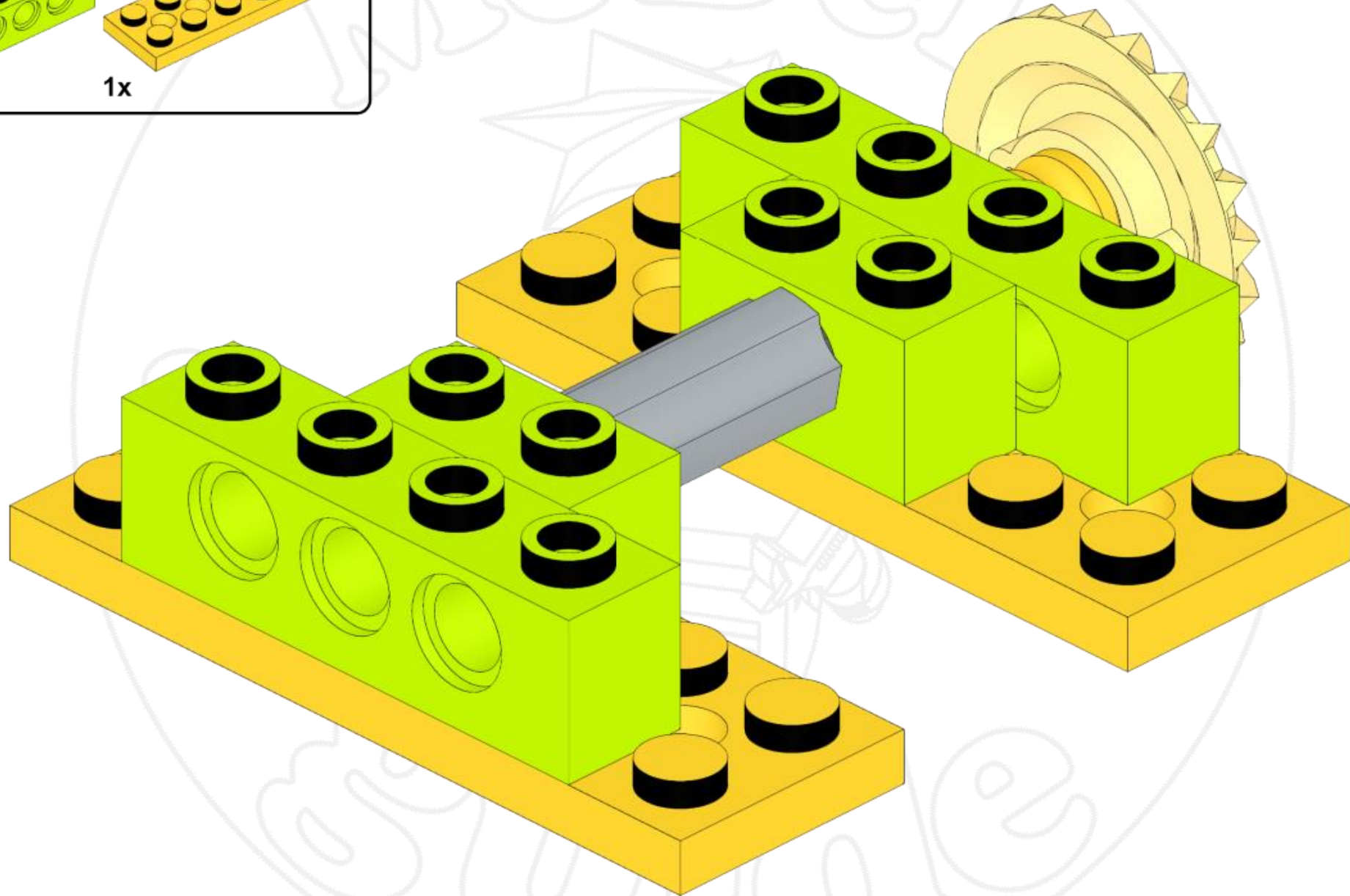
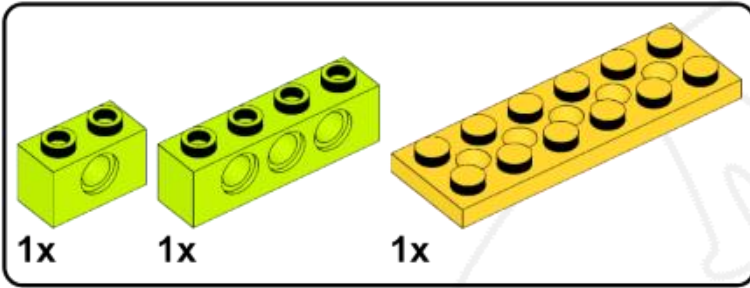

23

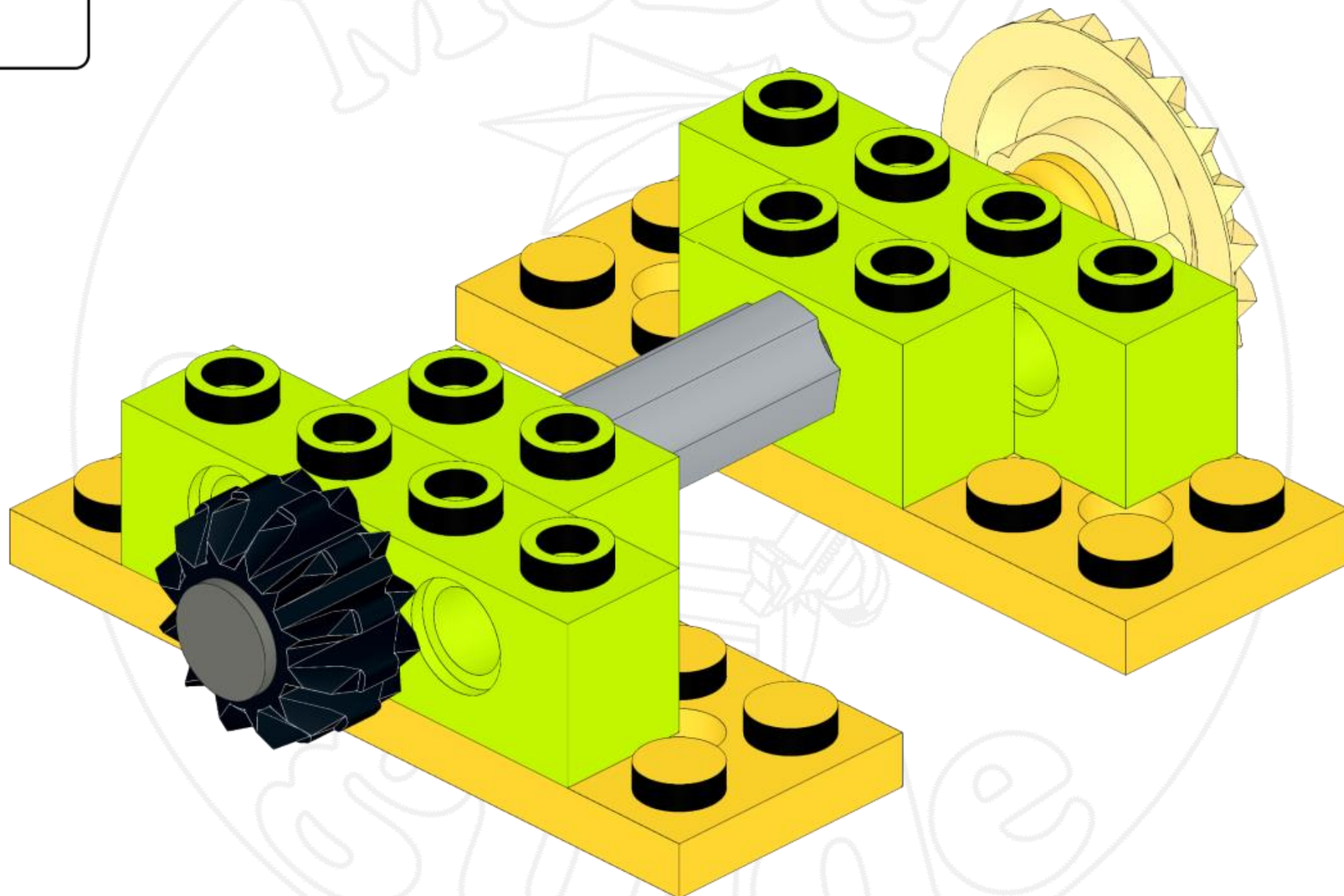
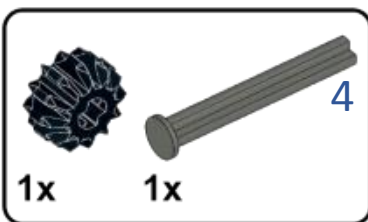



24

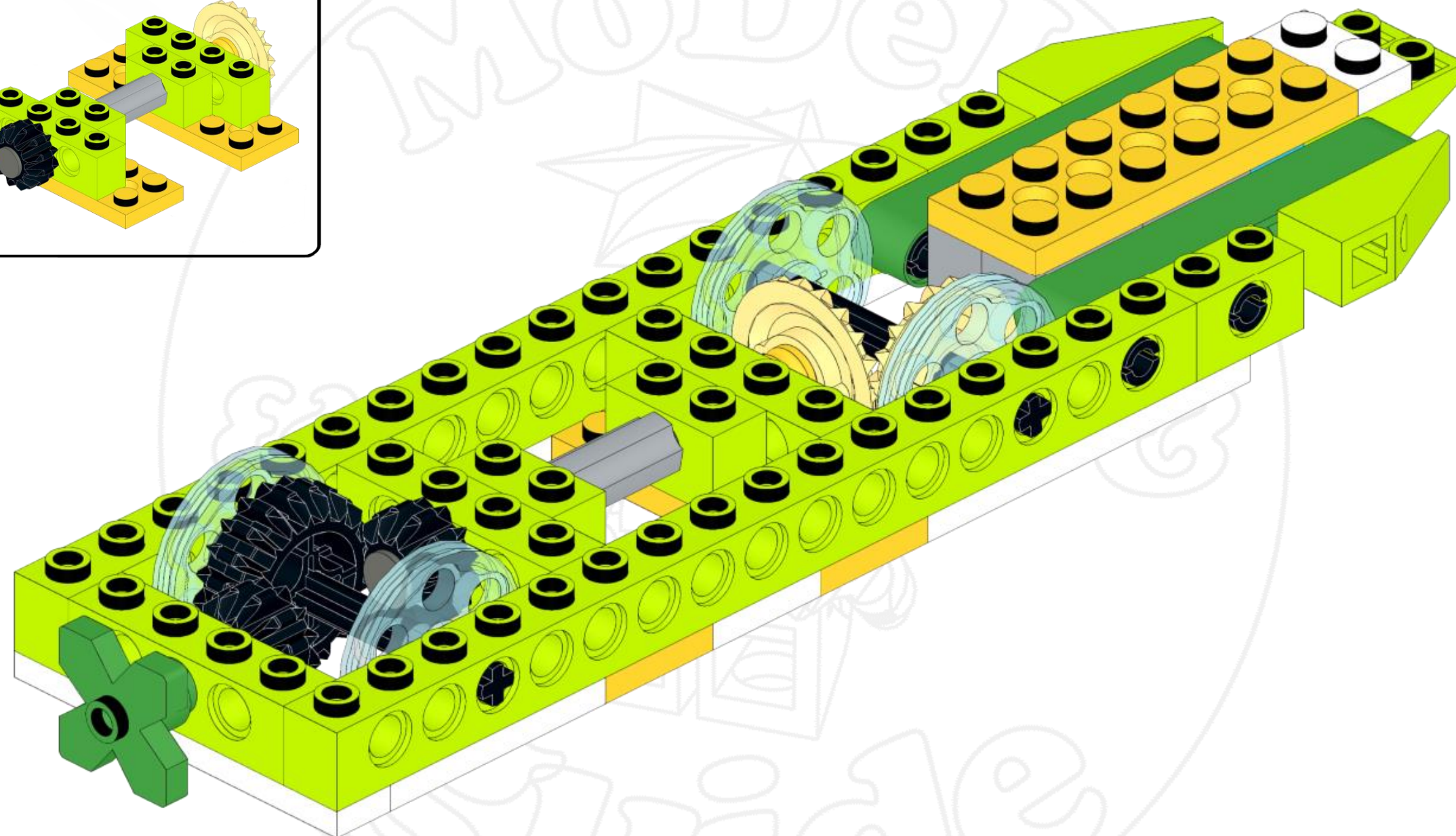
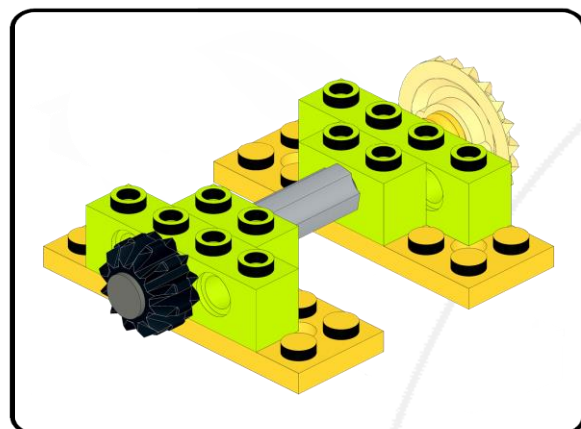

25

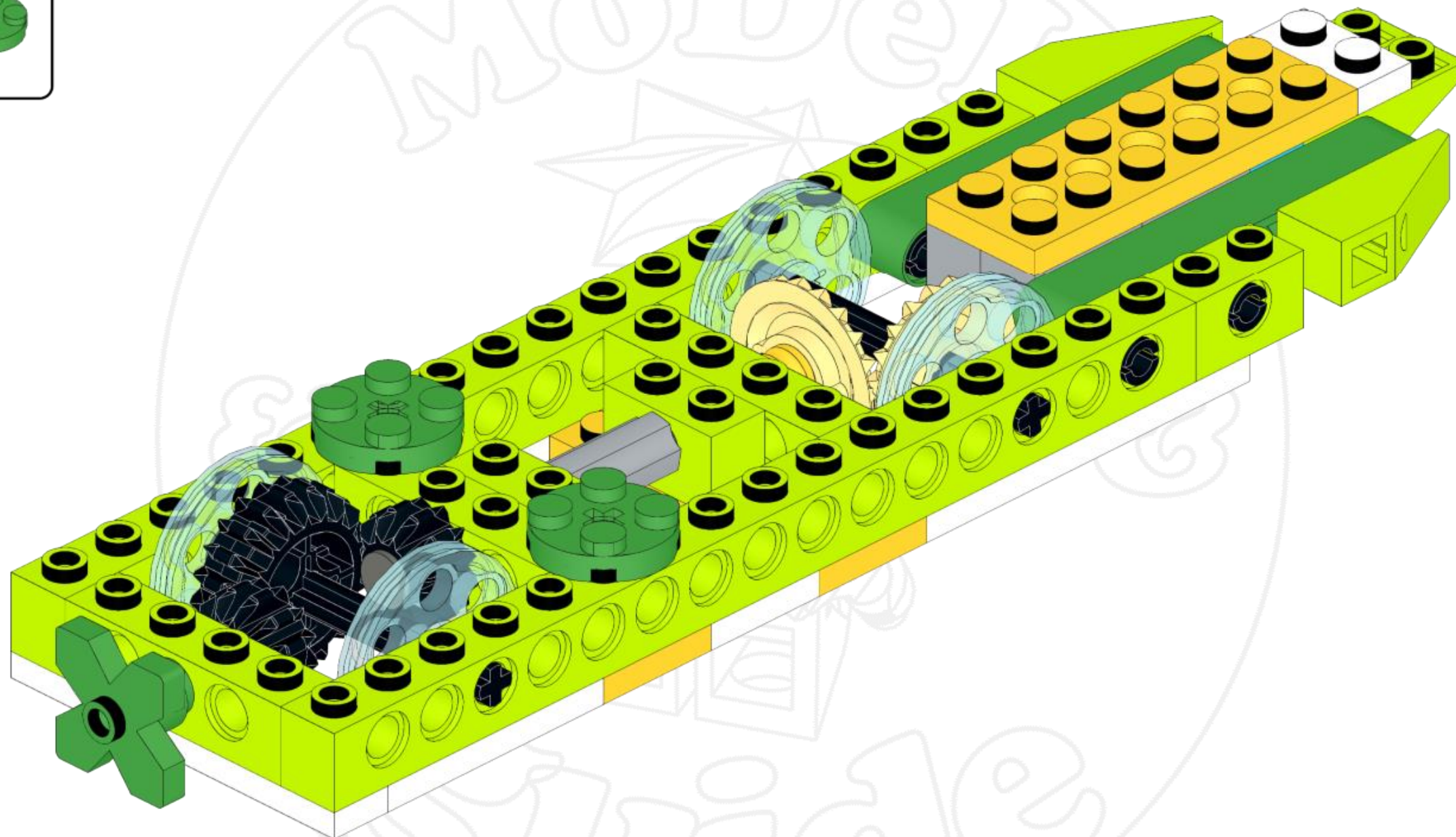
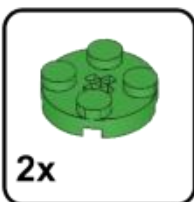

26

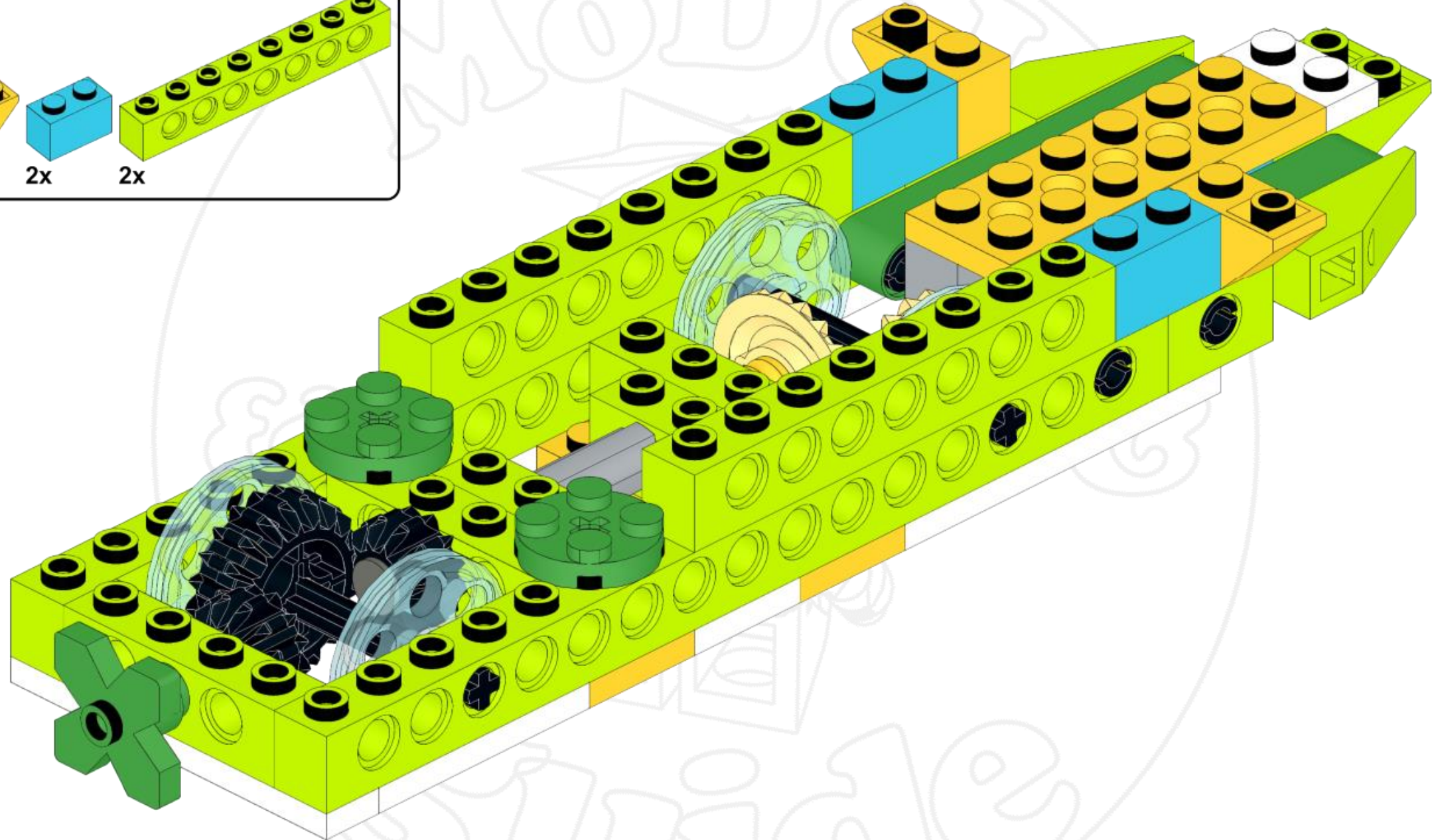
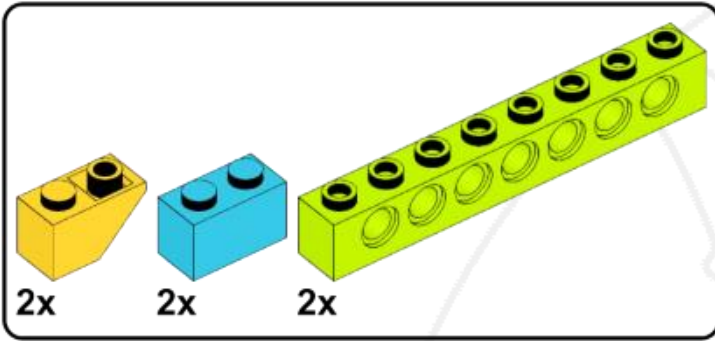

27

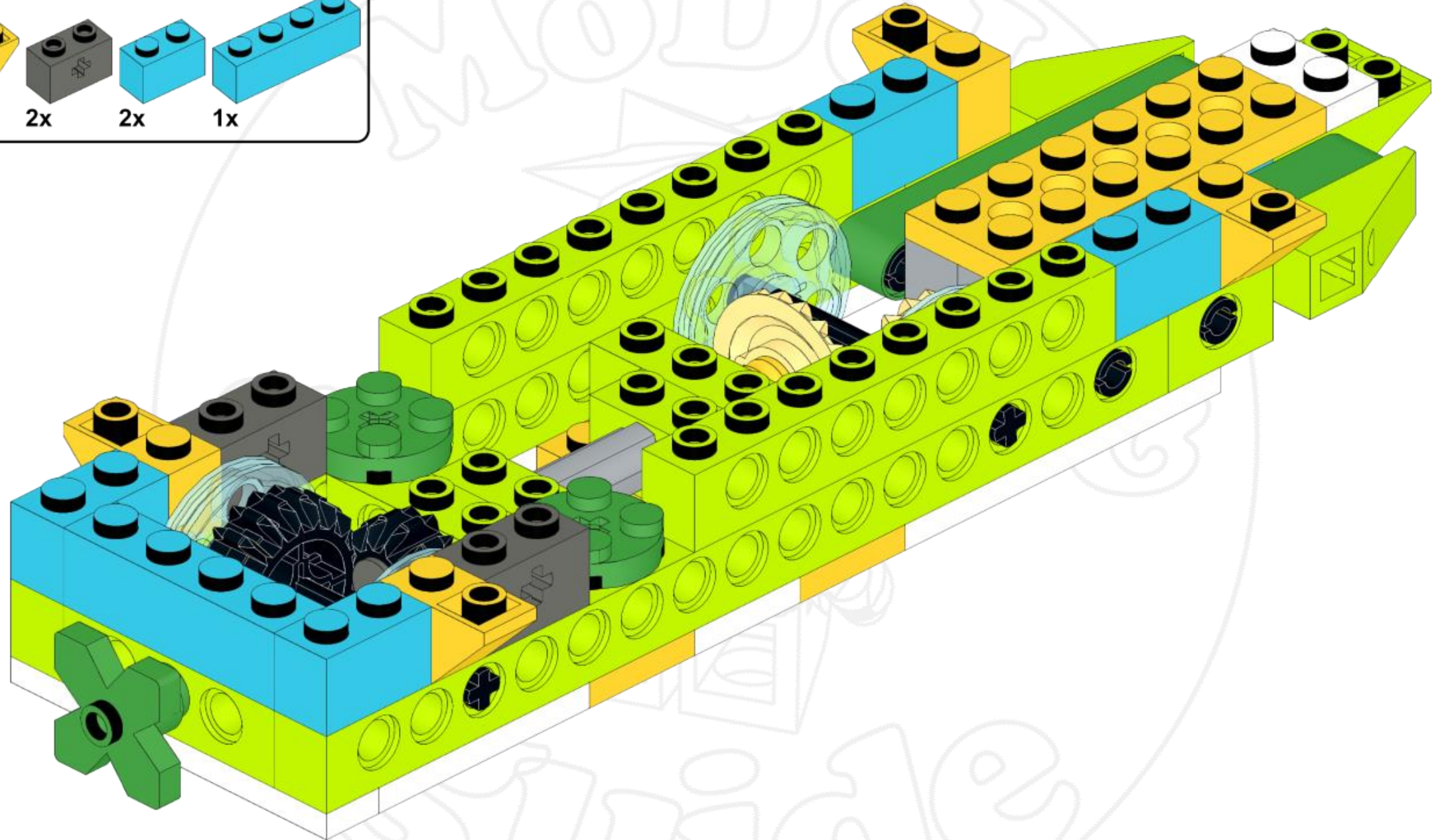
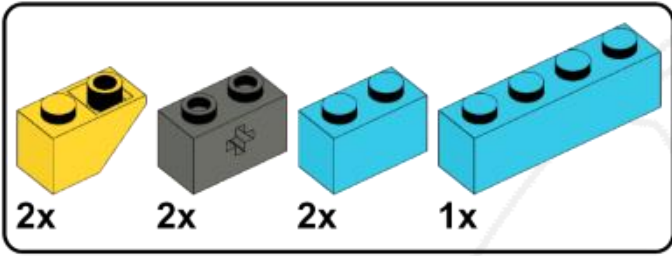

28

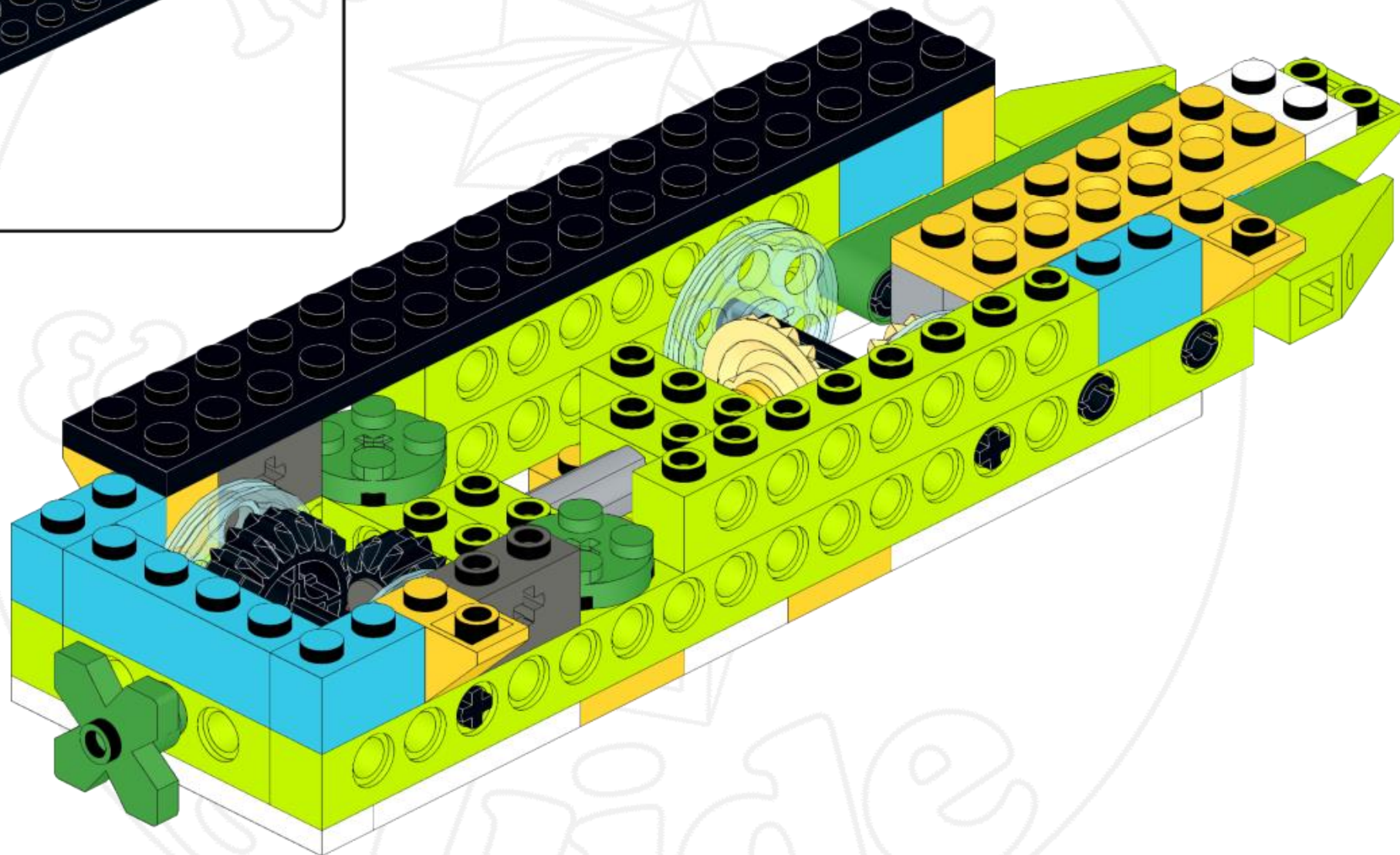
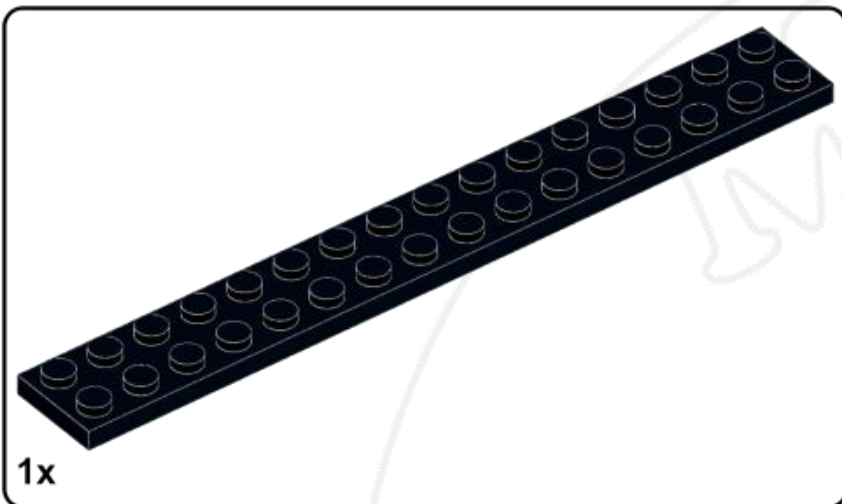

29

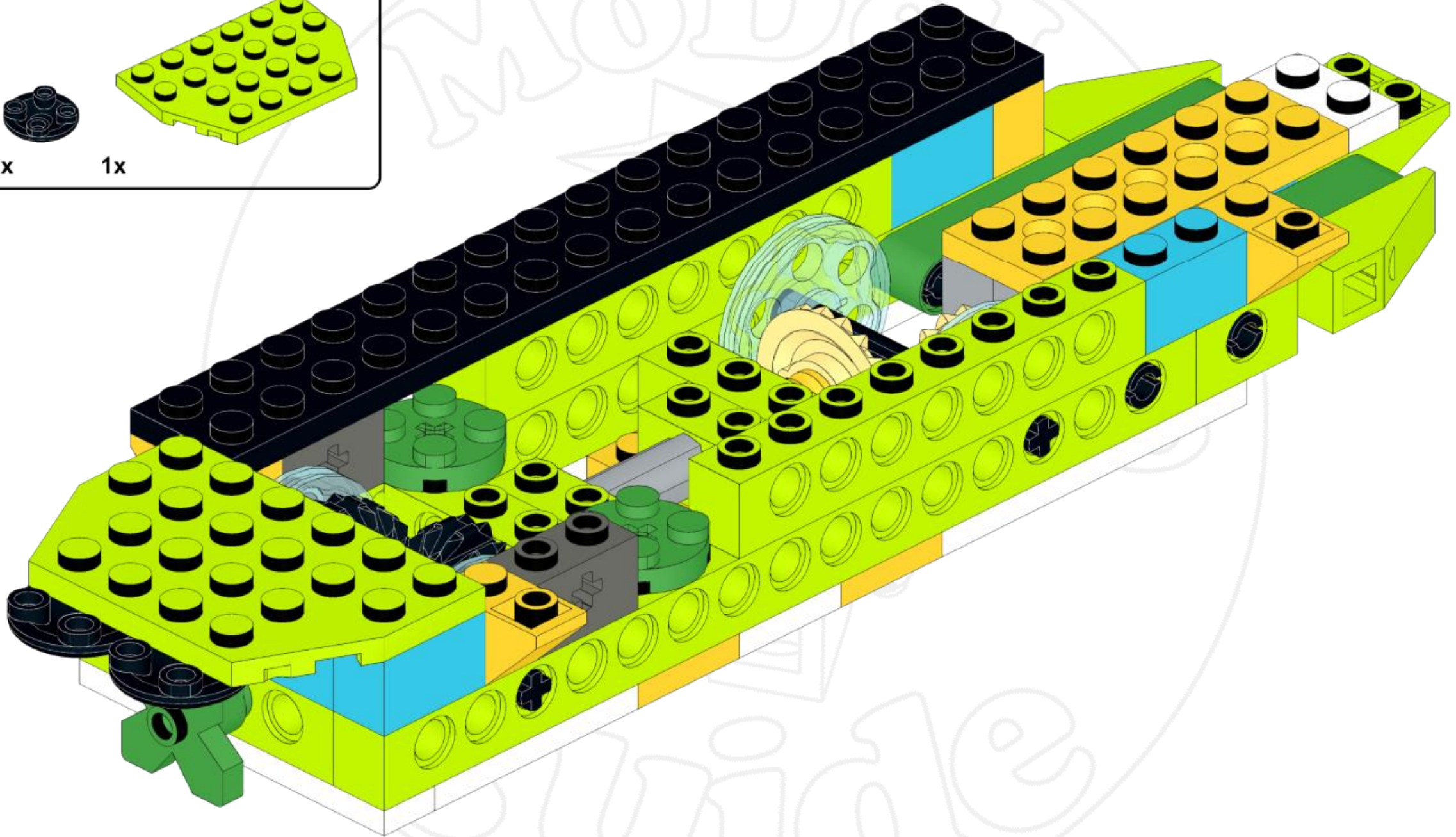
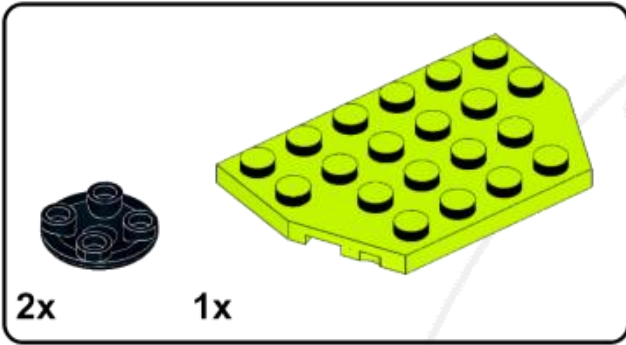

30

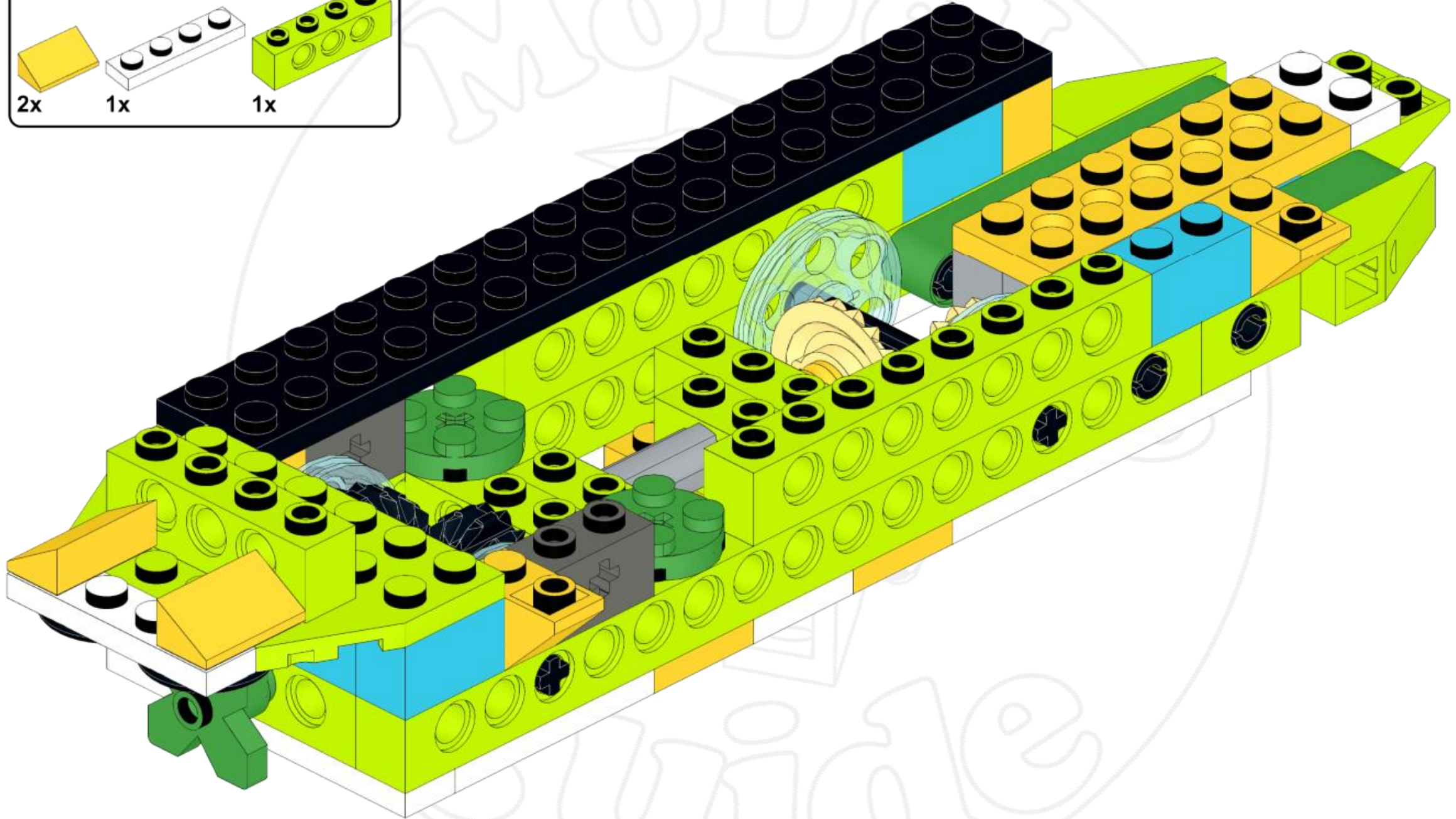
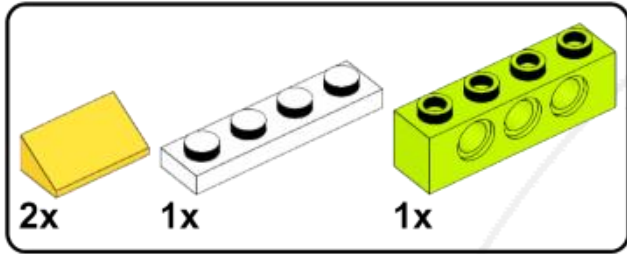

31

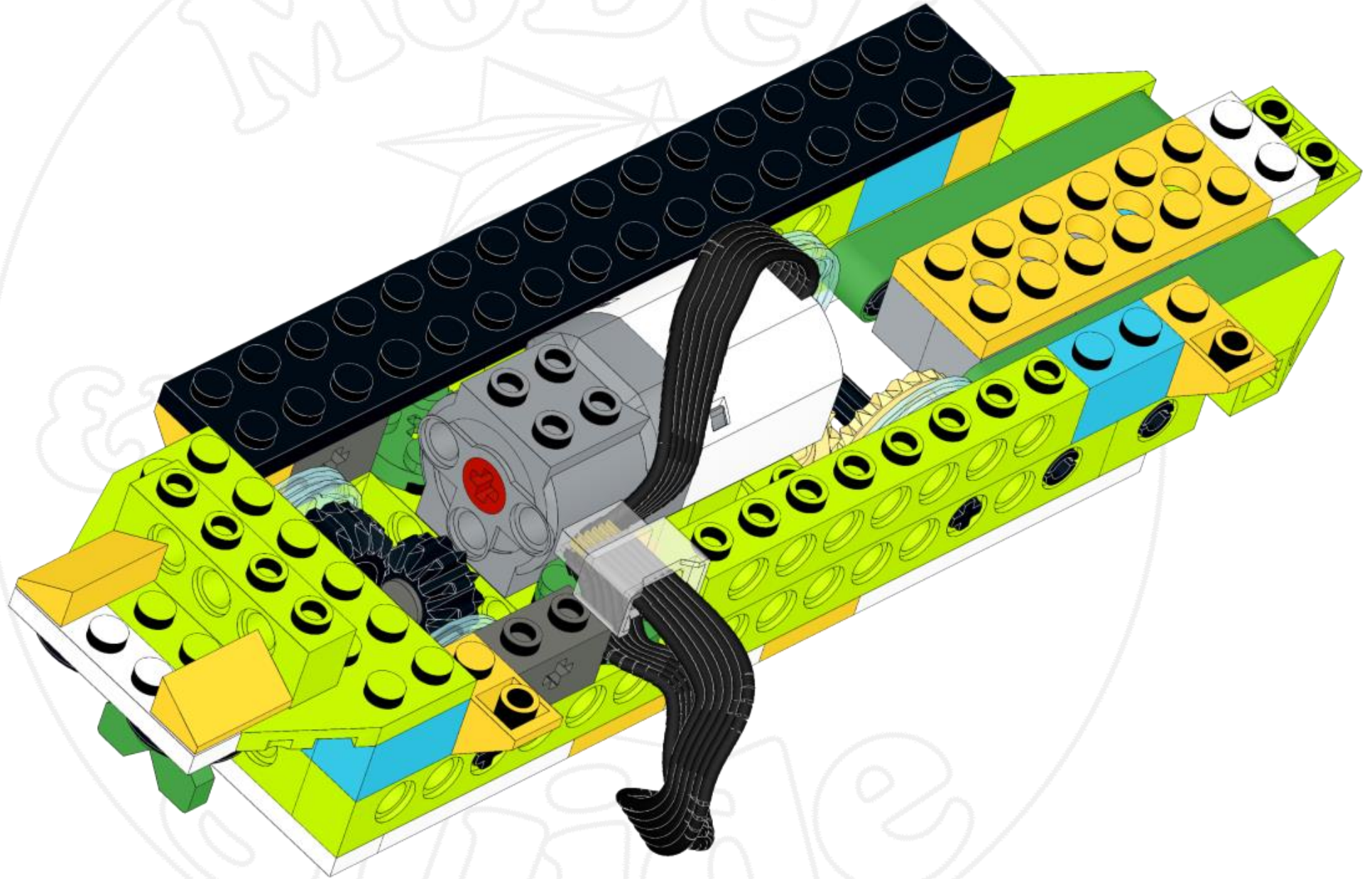



32

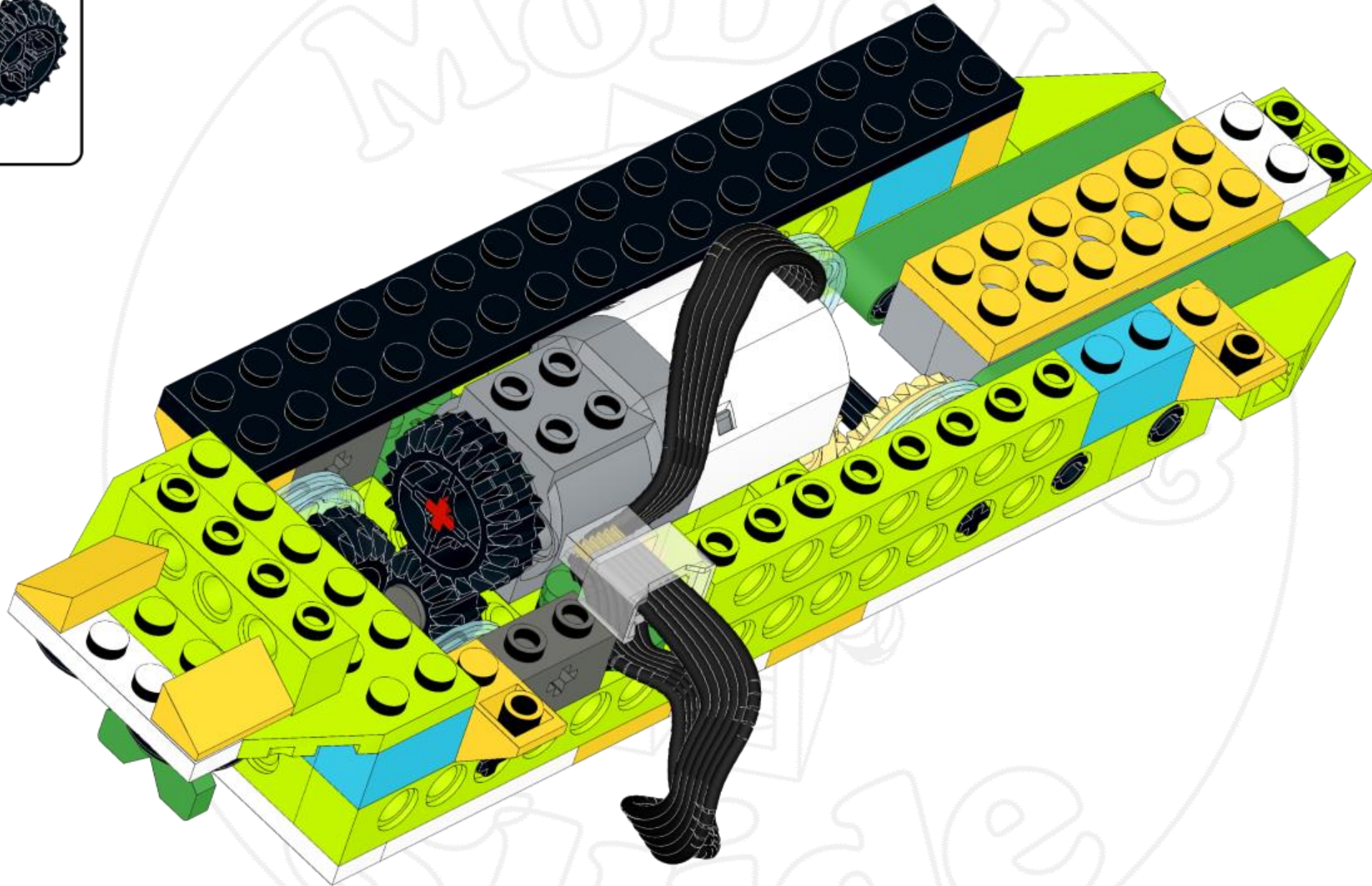
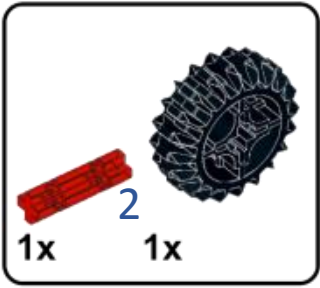

33

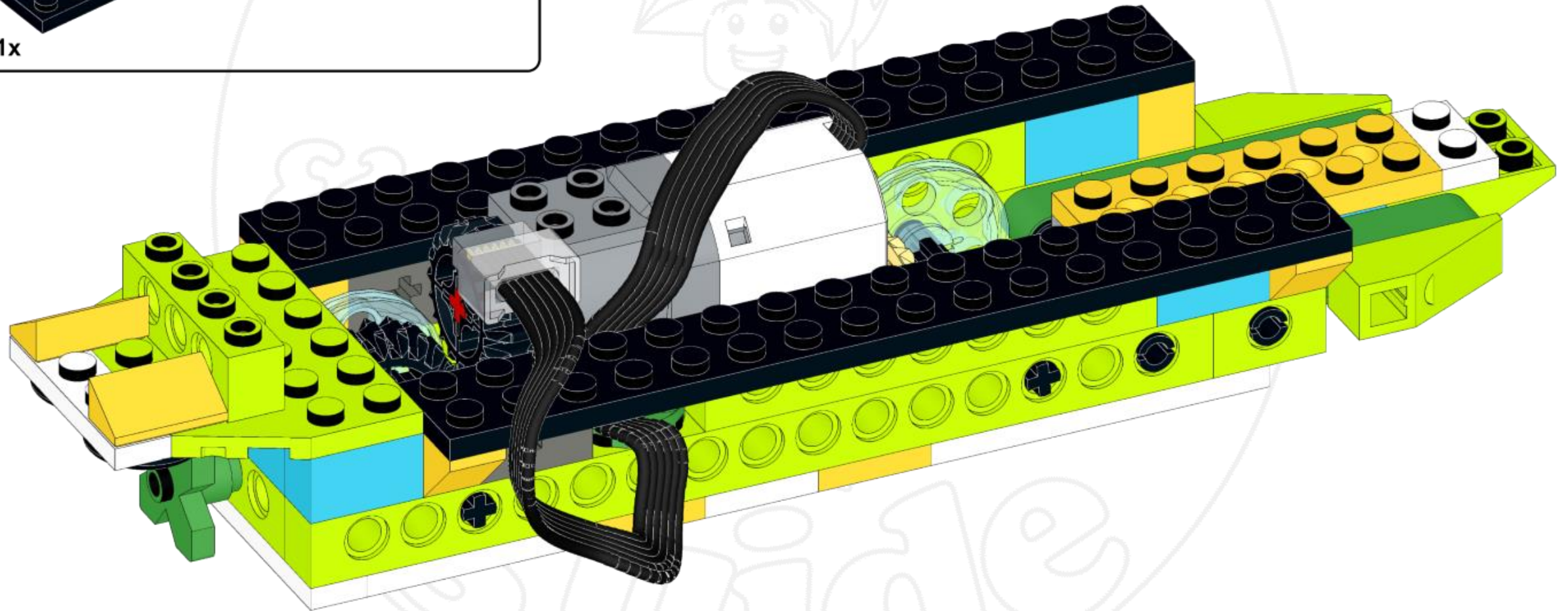
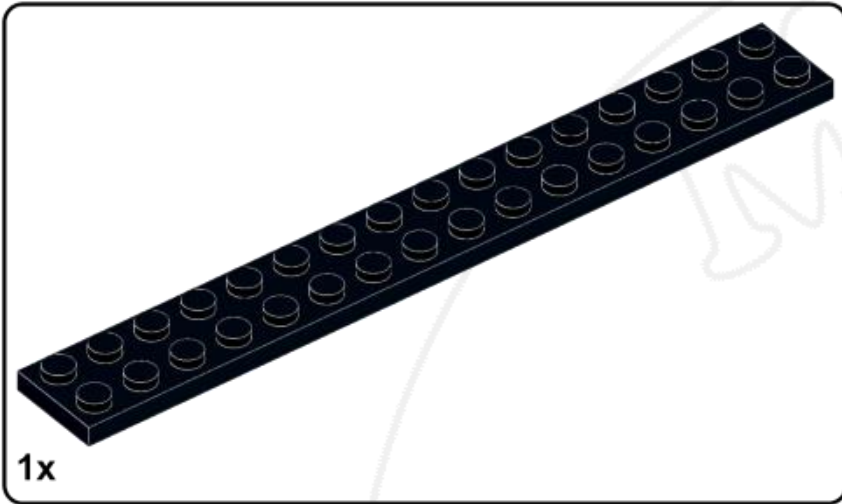

34

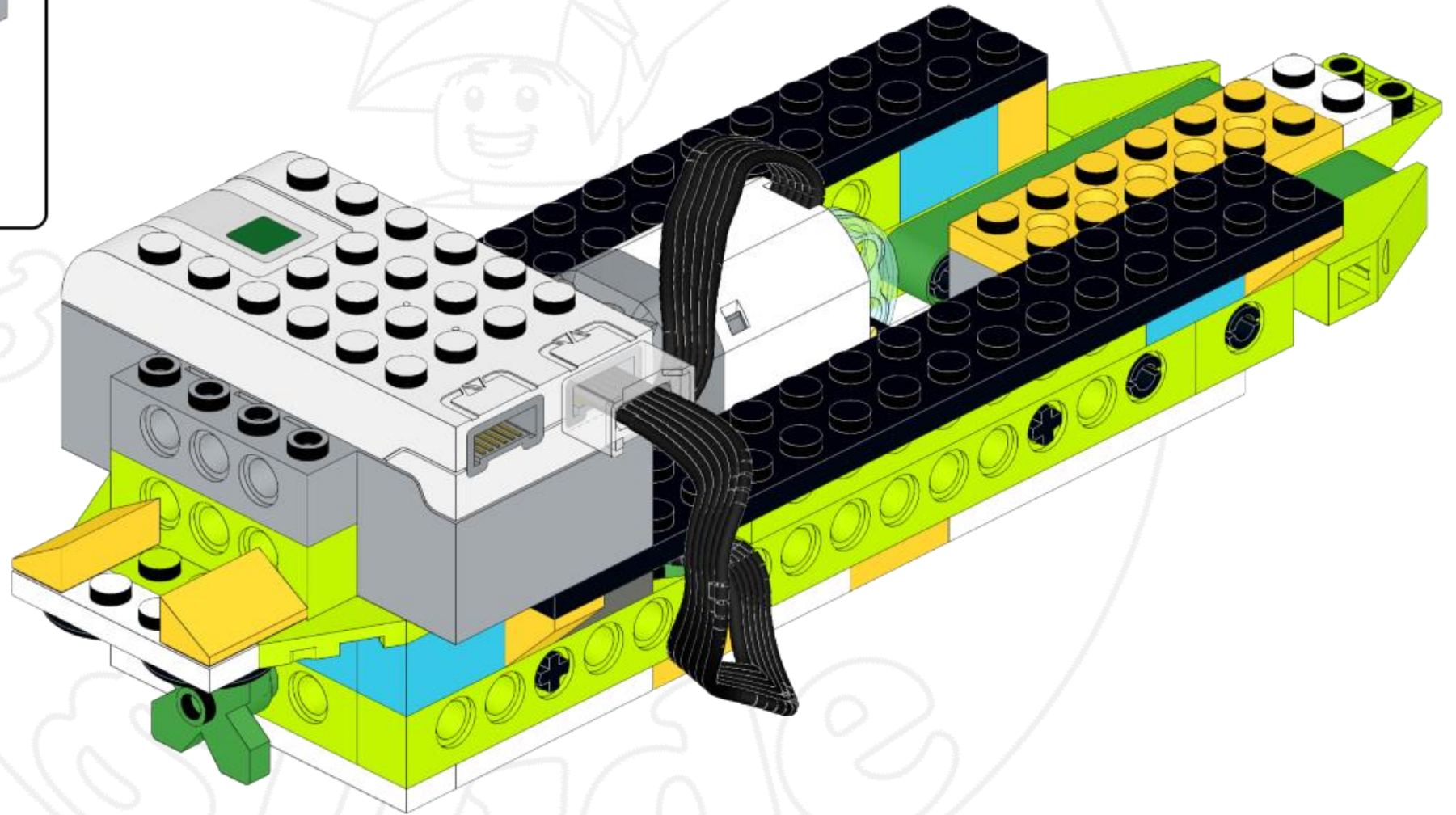
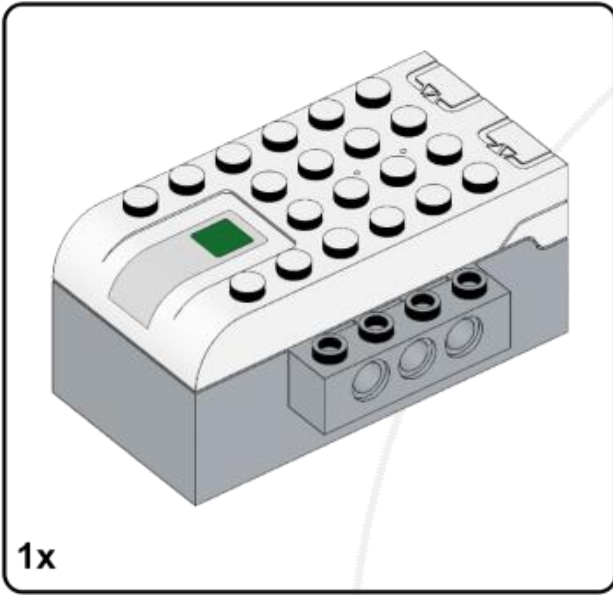

35

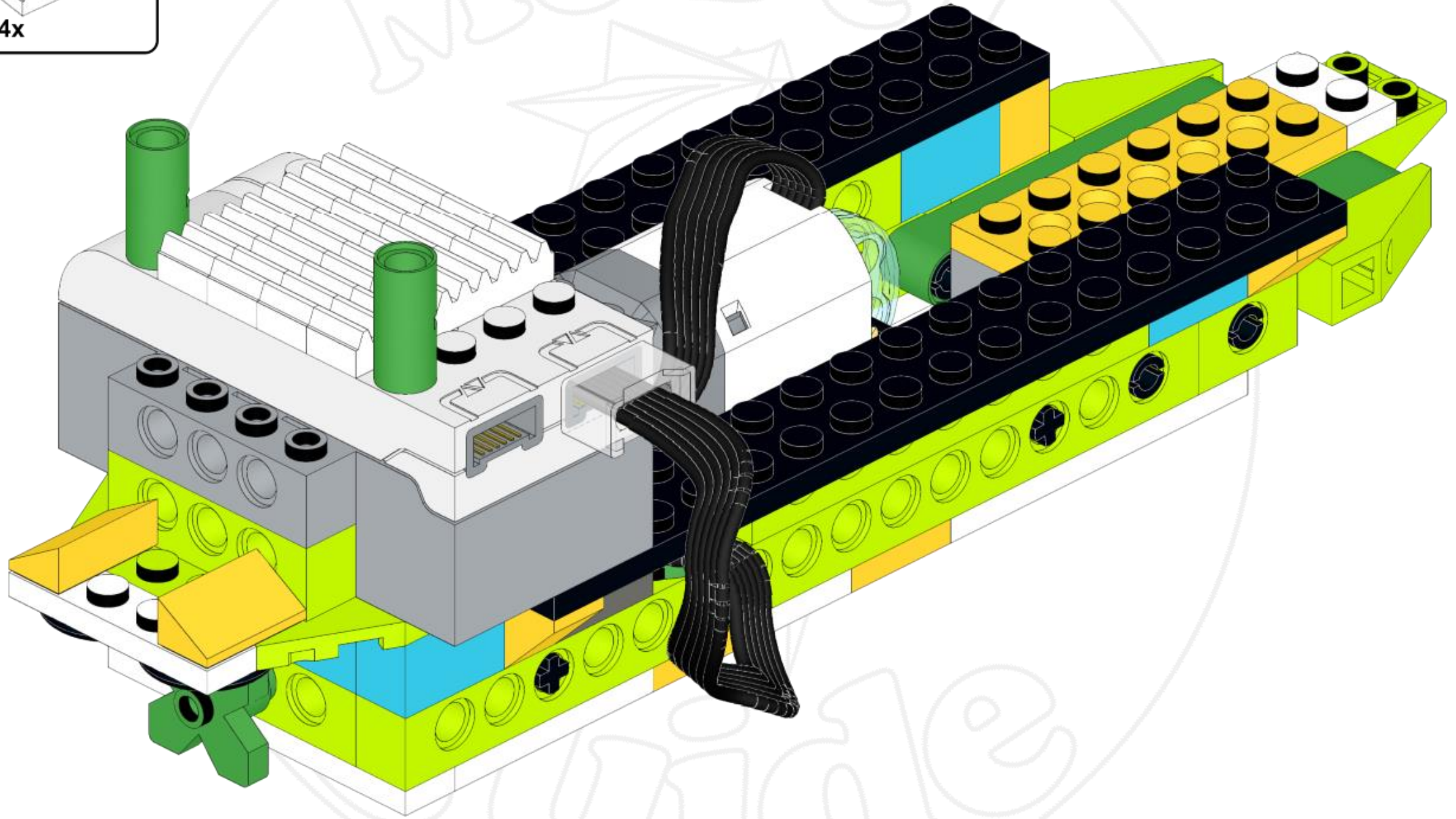
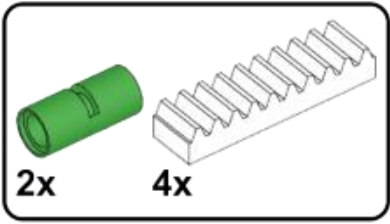

36

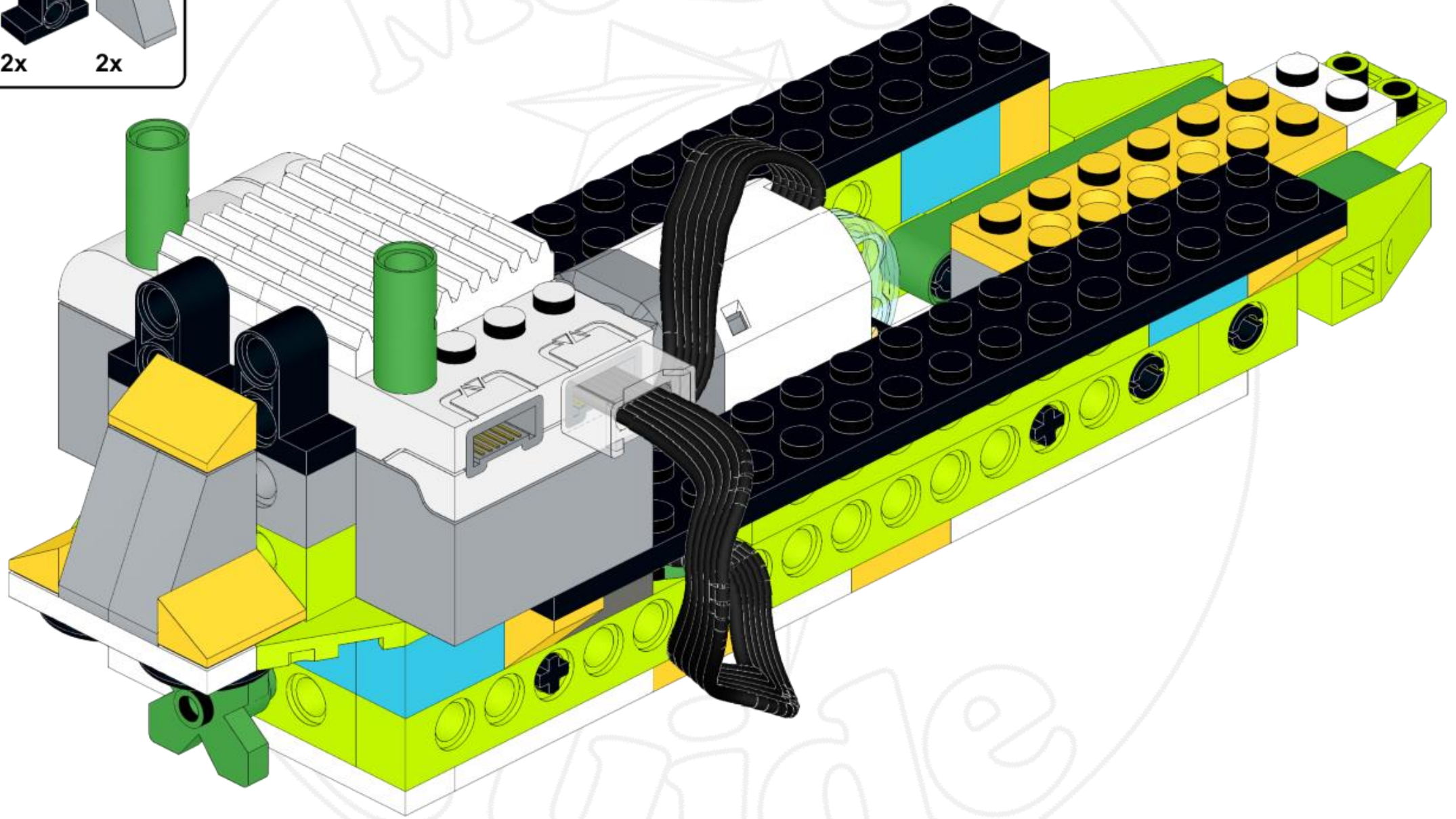
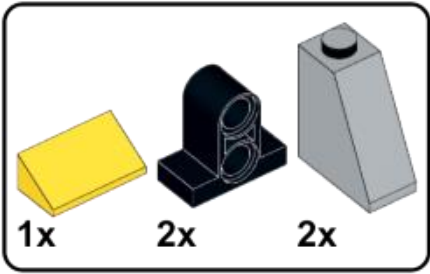

37

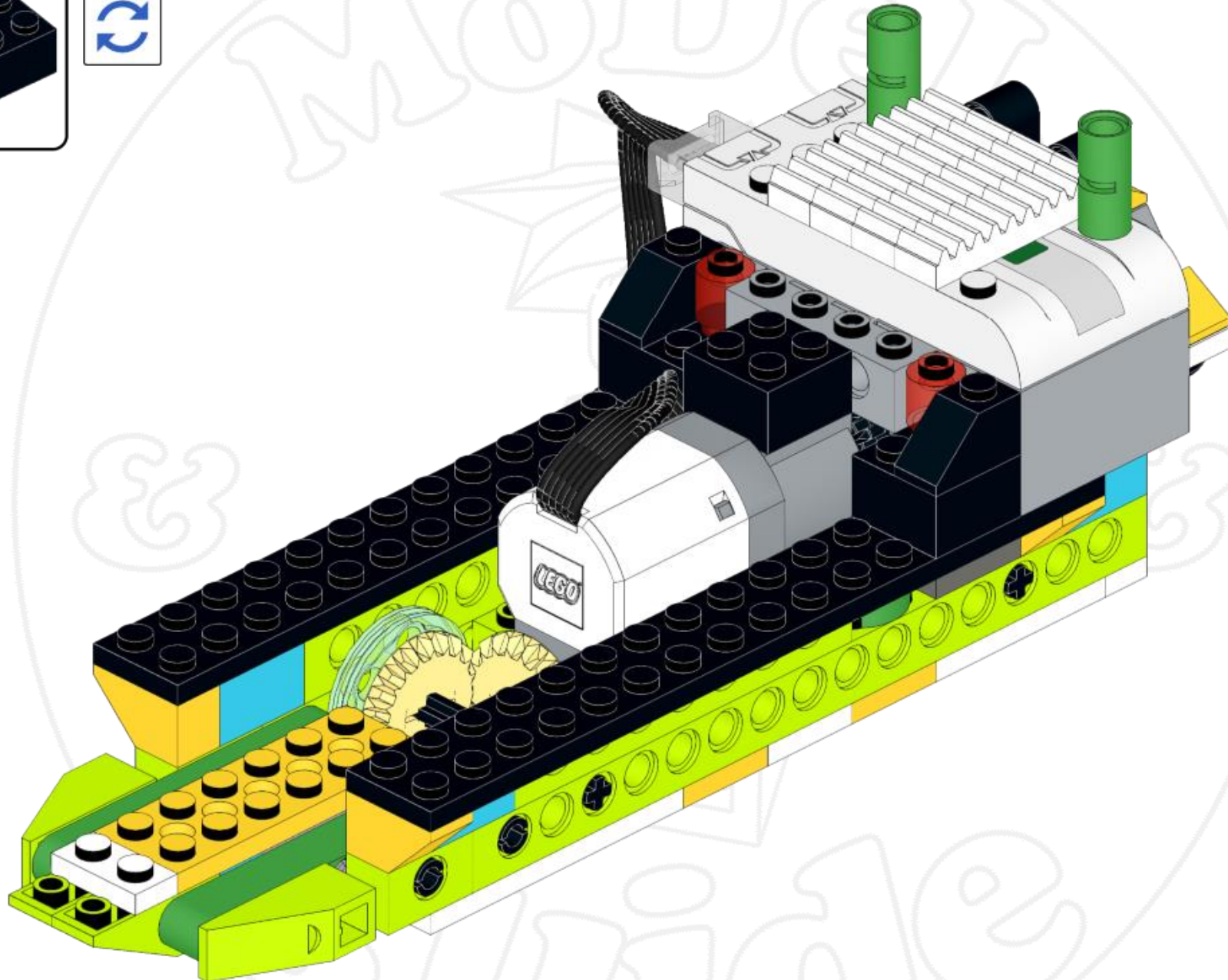
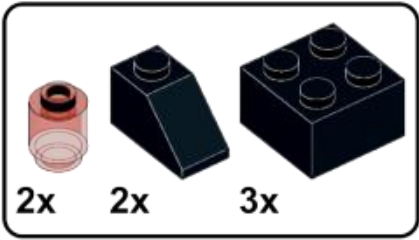

38

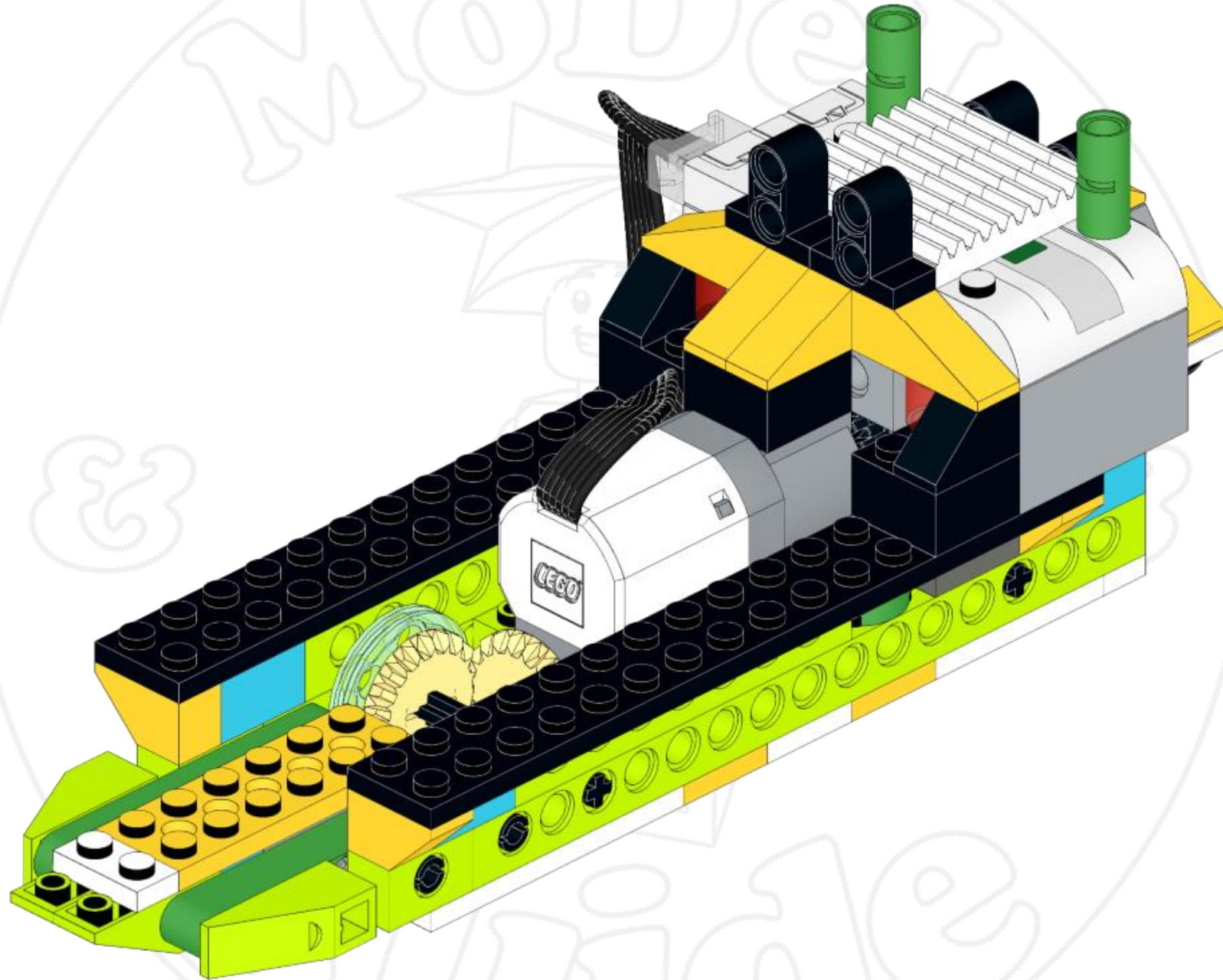
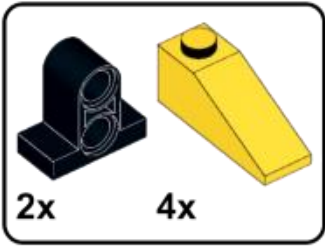

39

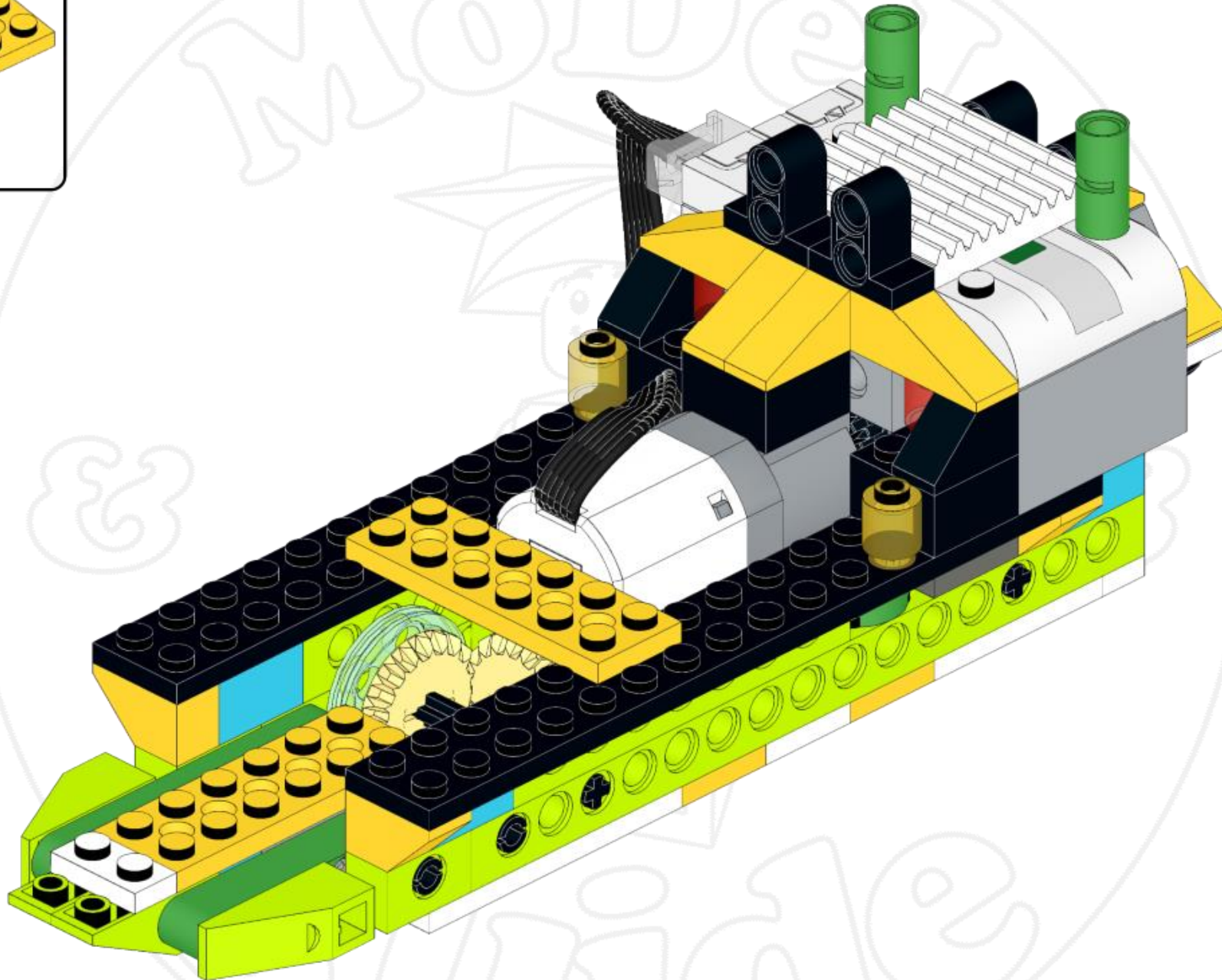
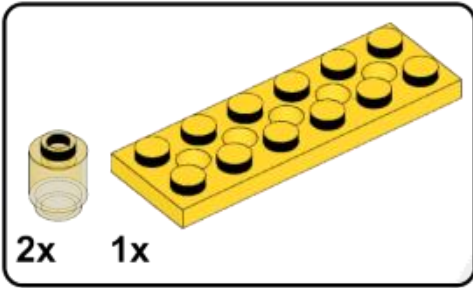



40

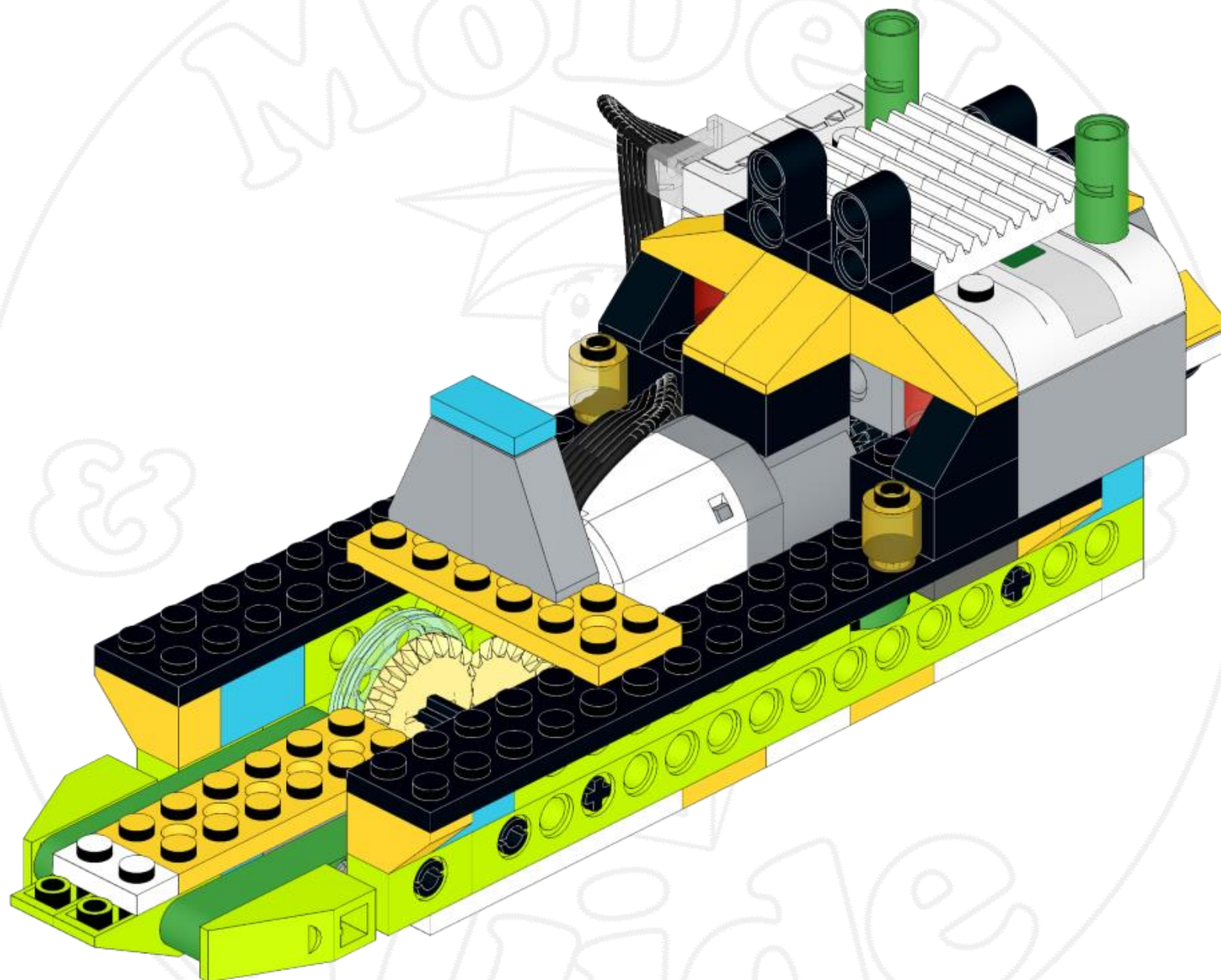
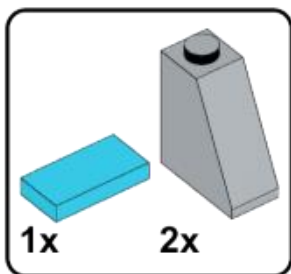

41

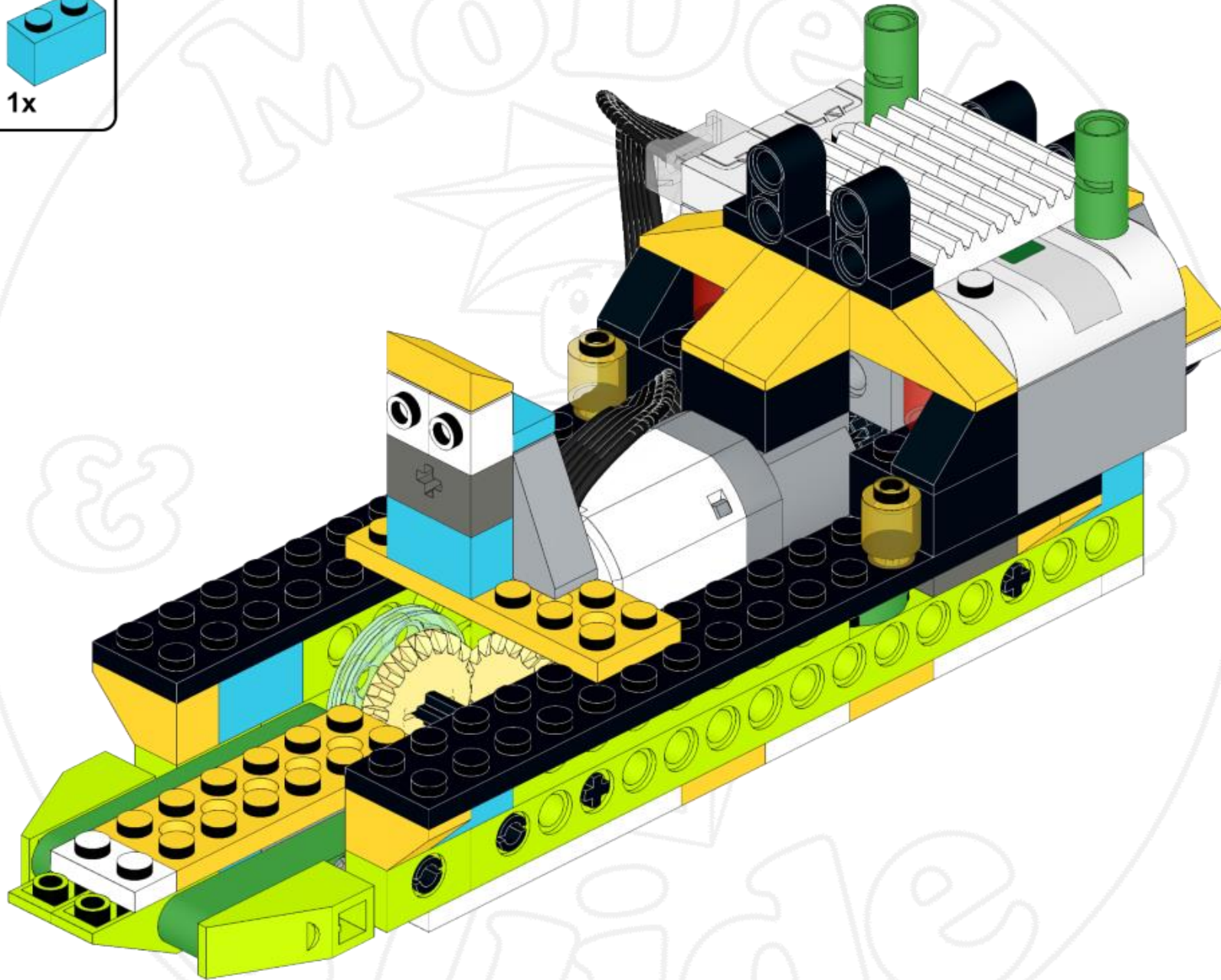
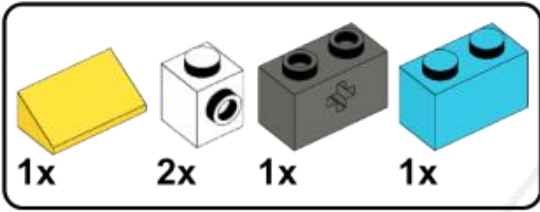

42

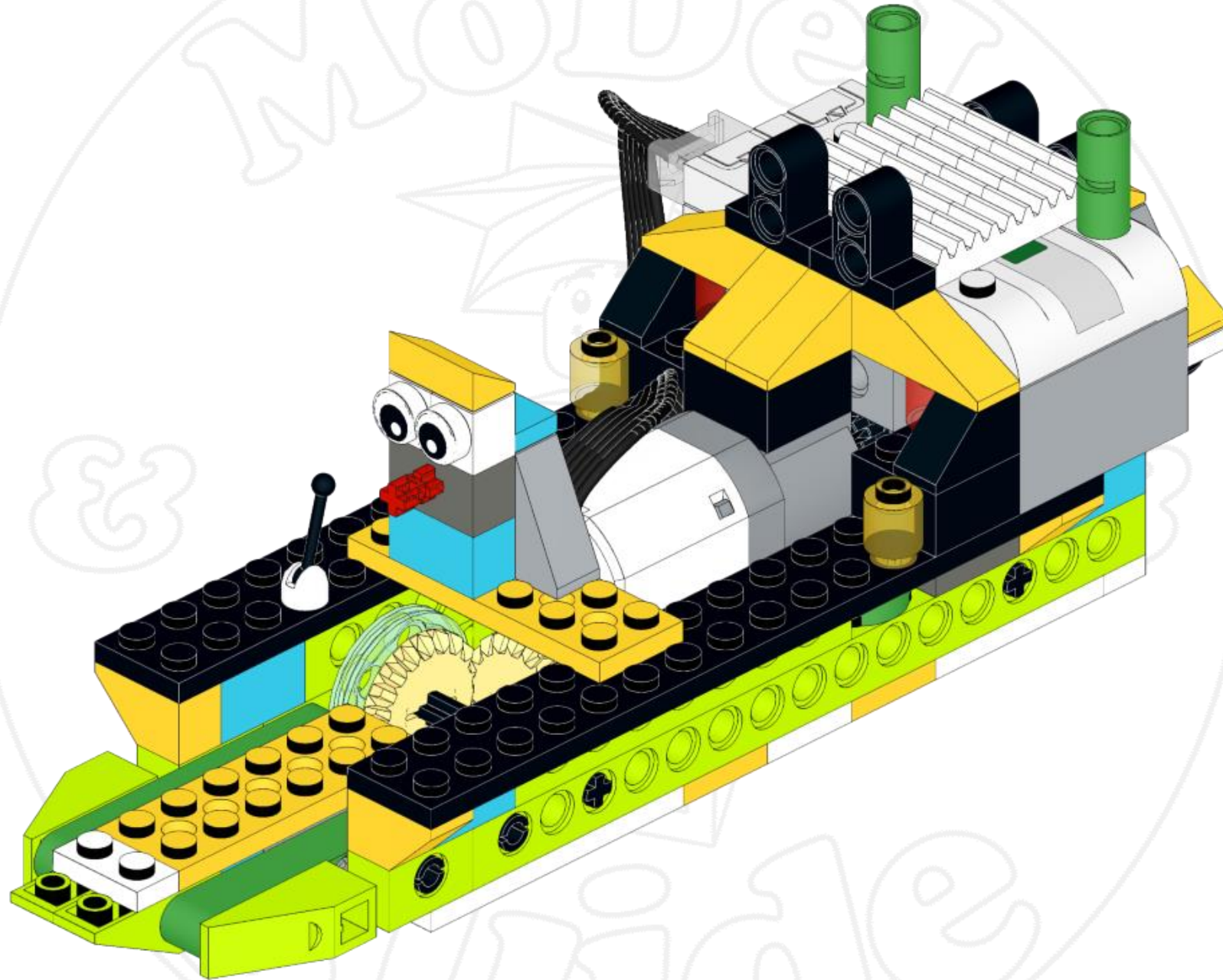
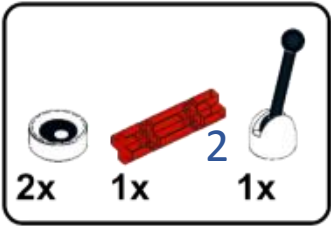

43

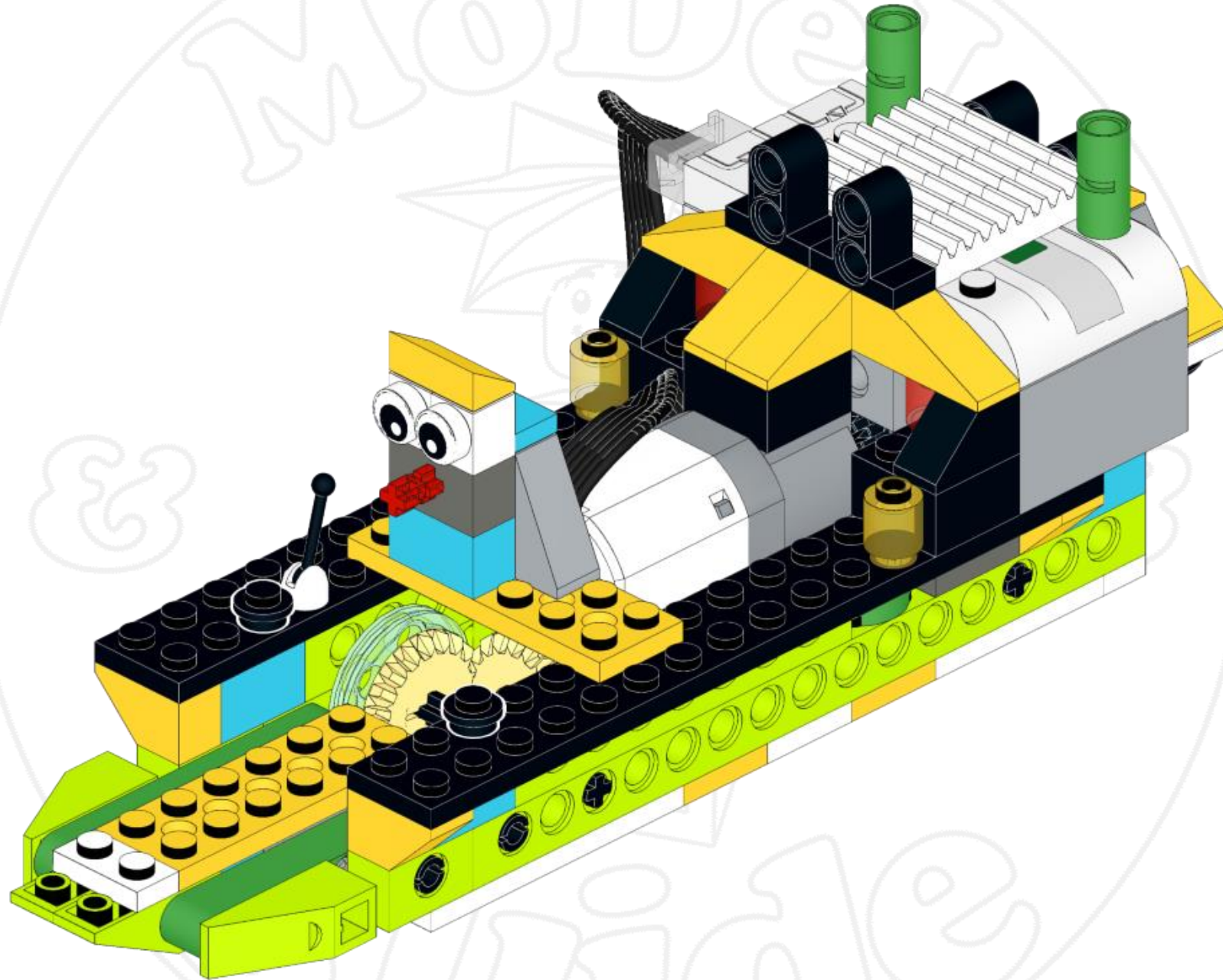

44

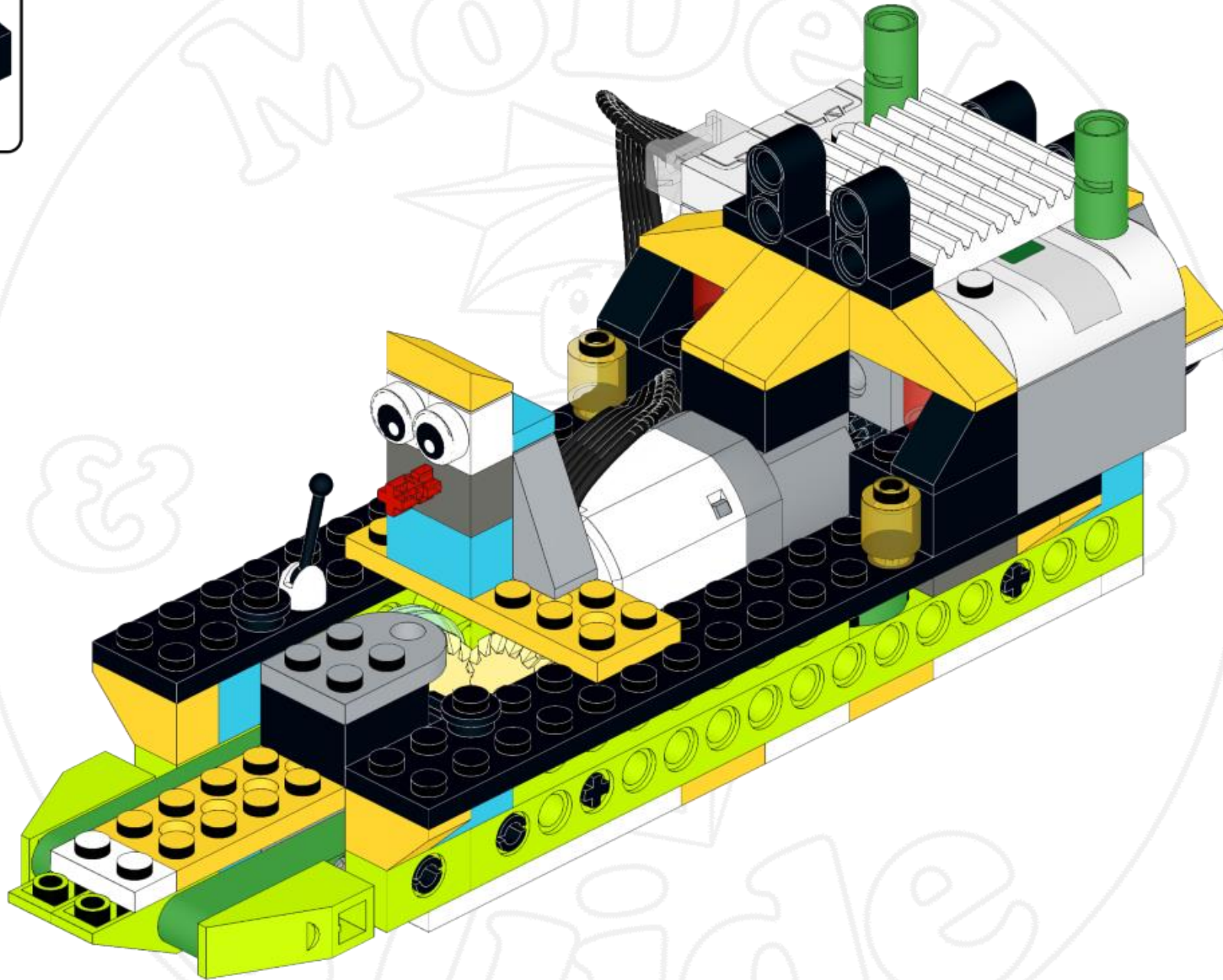
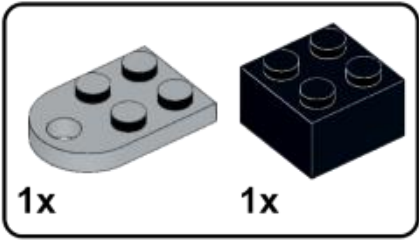

45

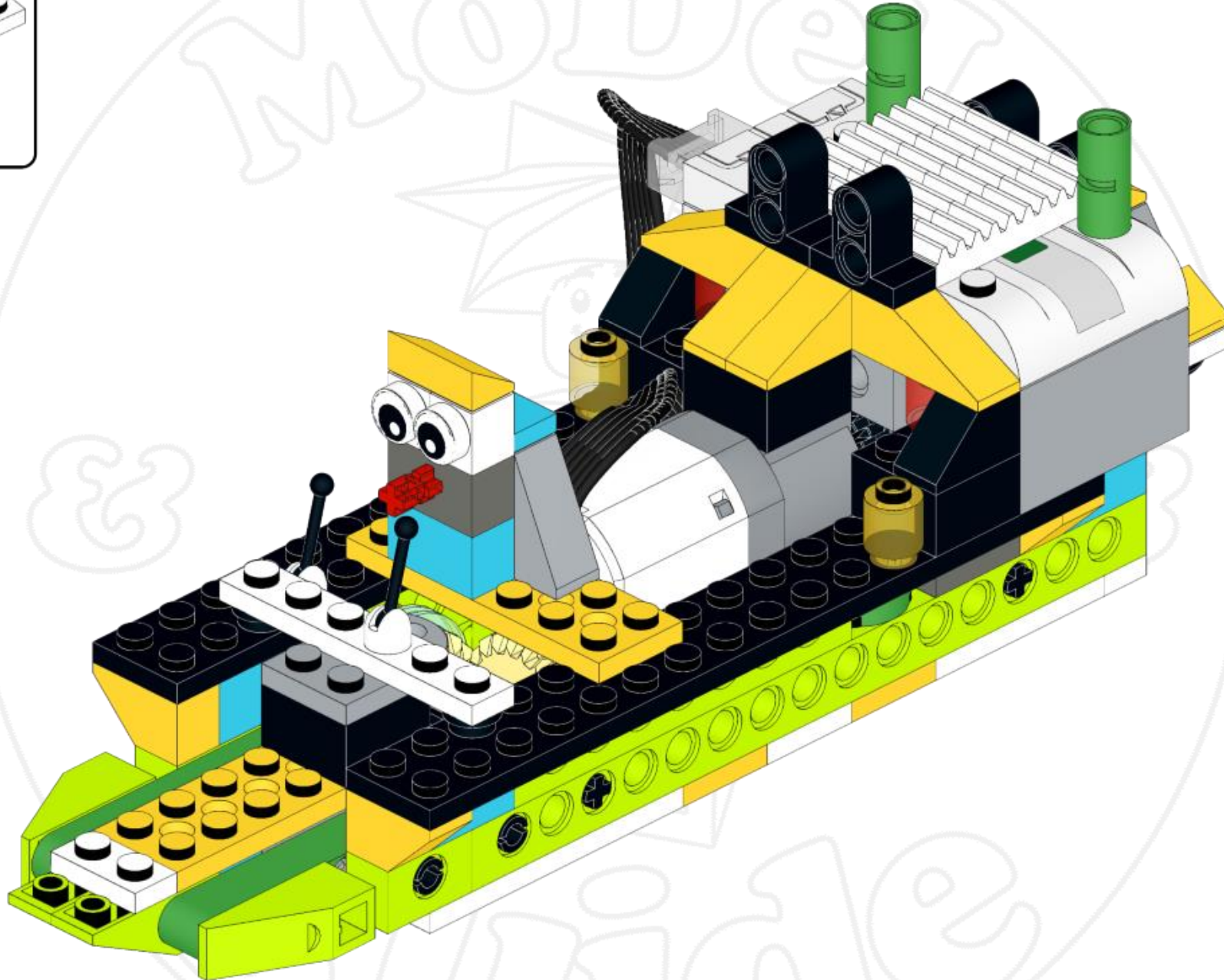
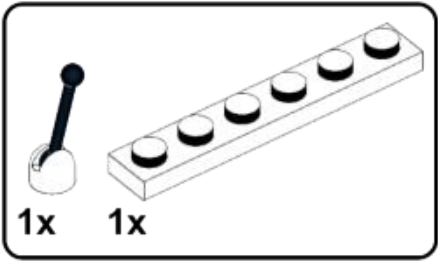

46

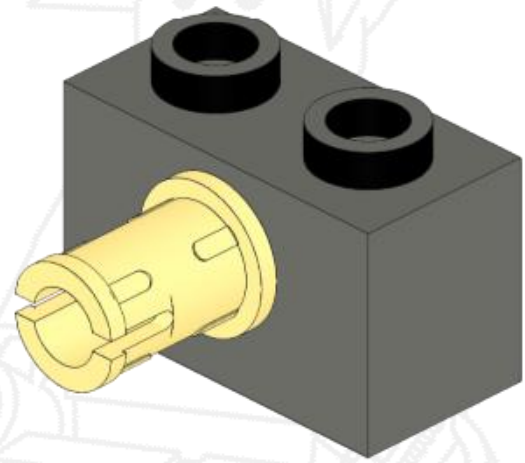
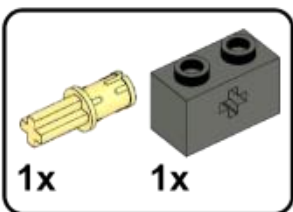

Model  
&  
Guide

47

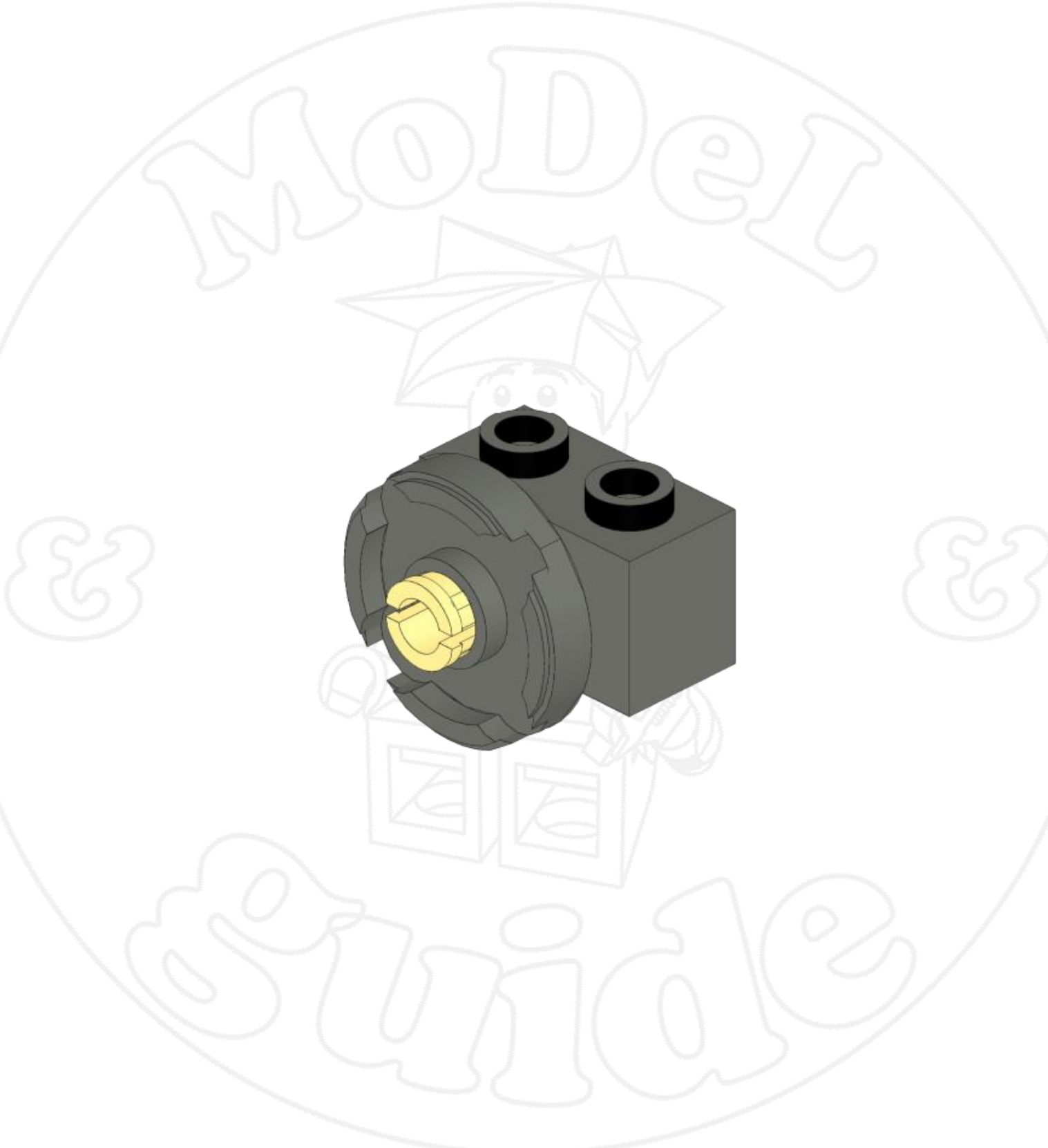
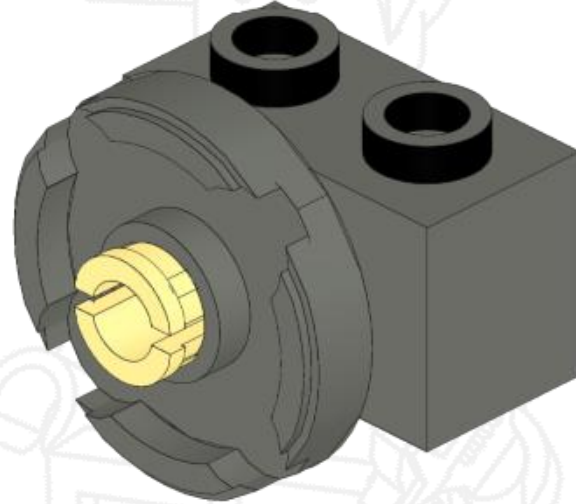
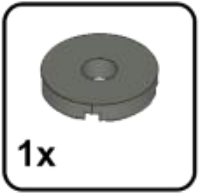



48

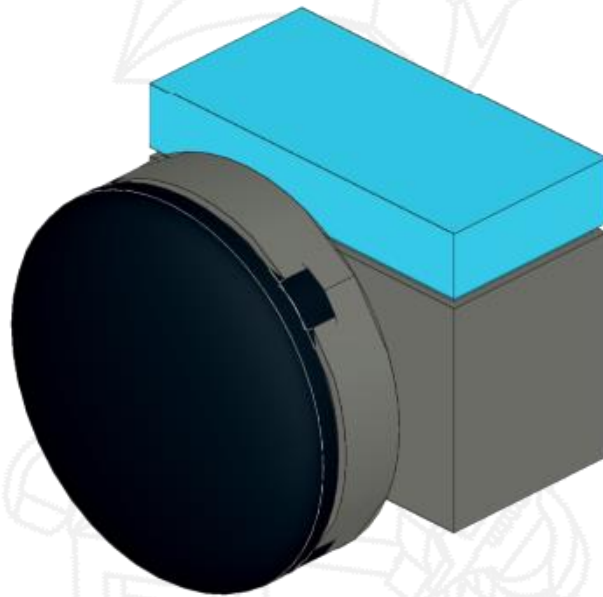
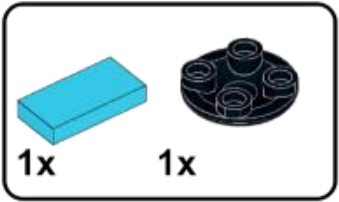

Model  
& &  
Guide

49

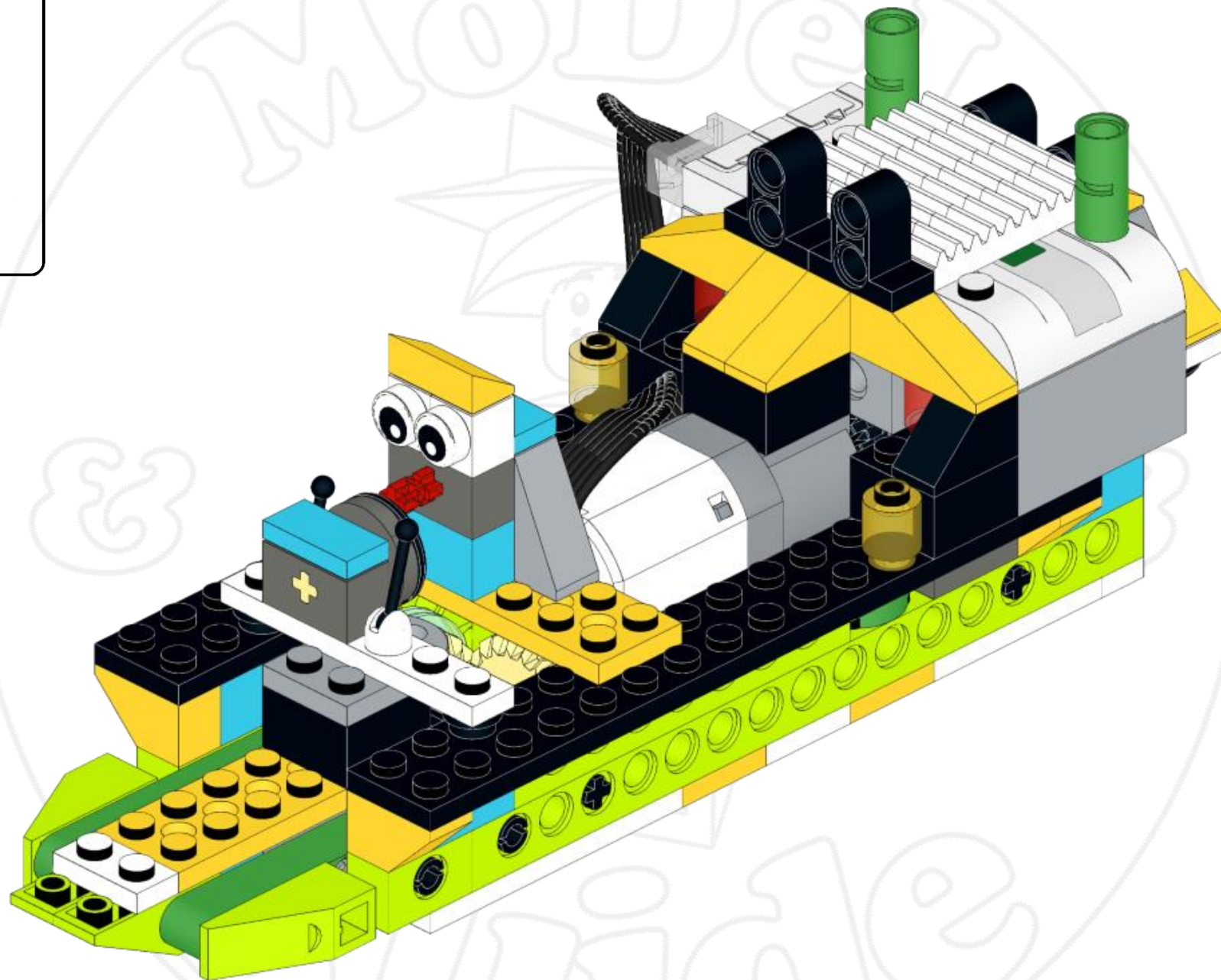
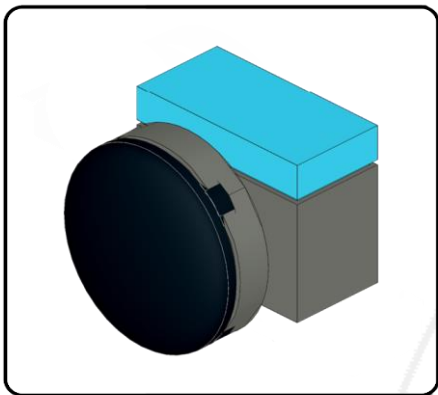

50

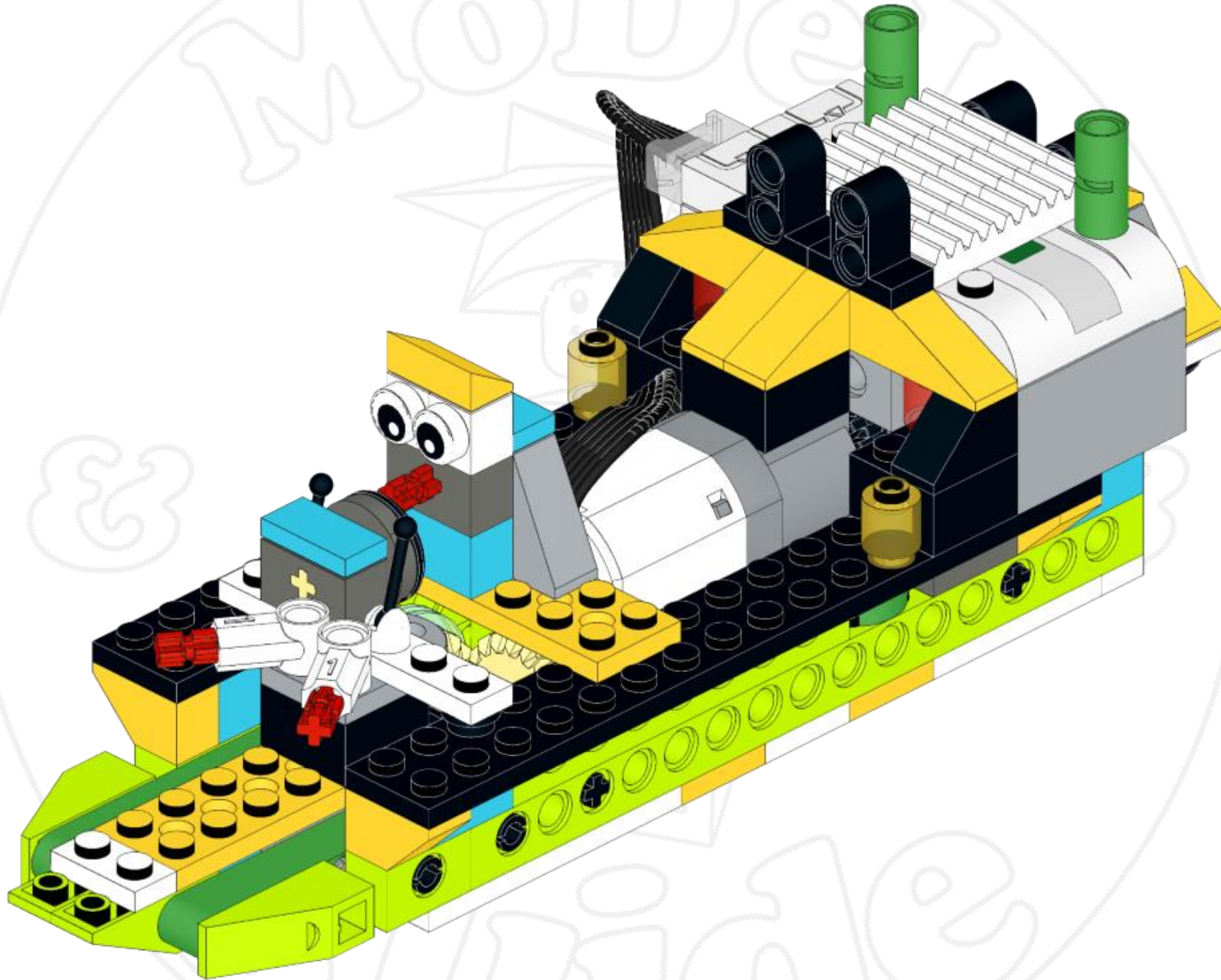
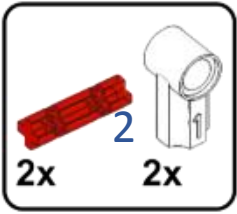

51

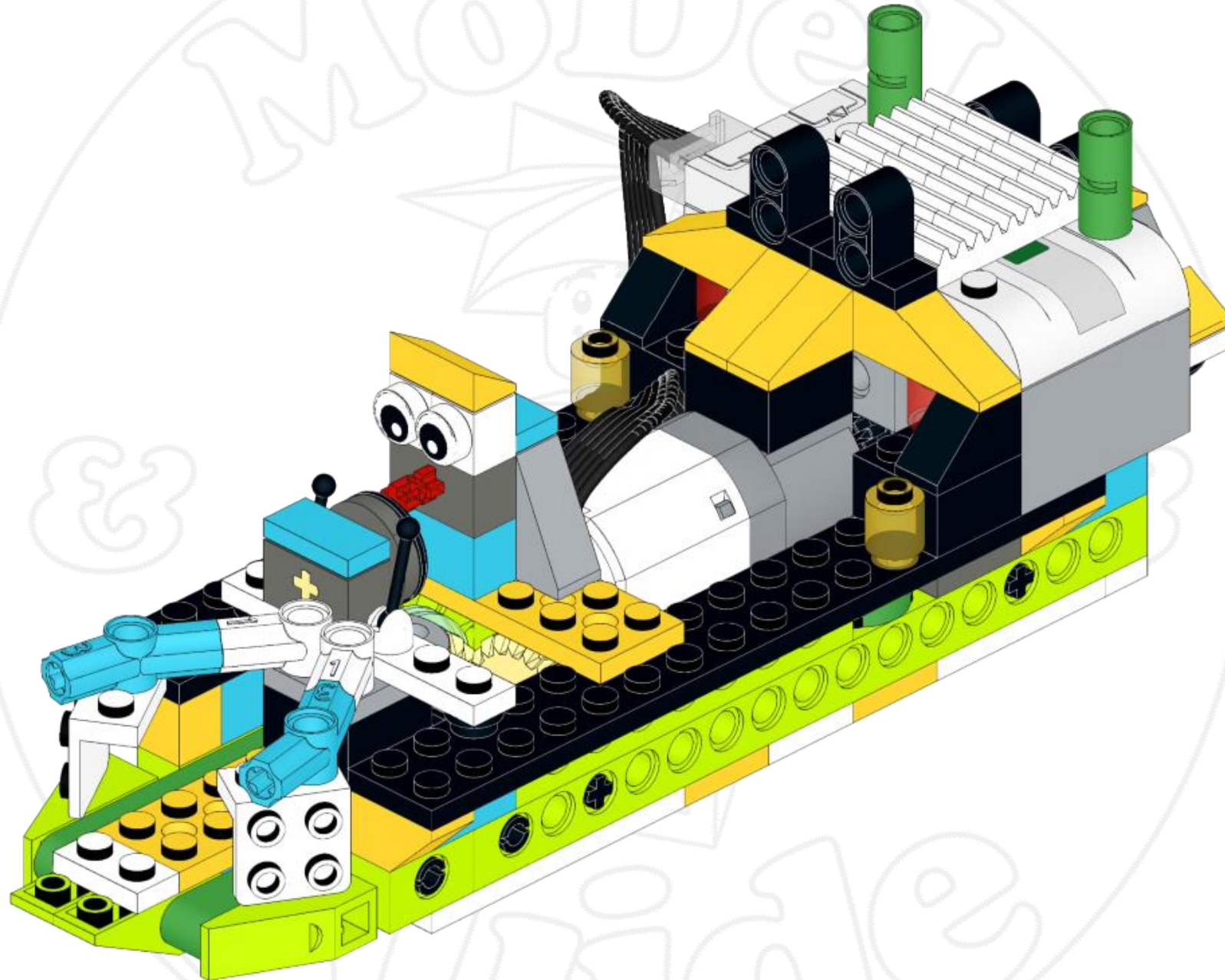
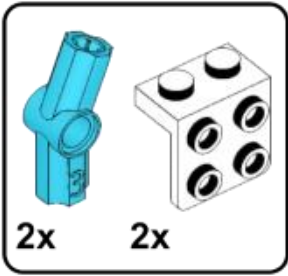

52

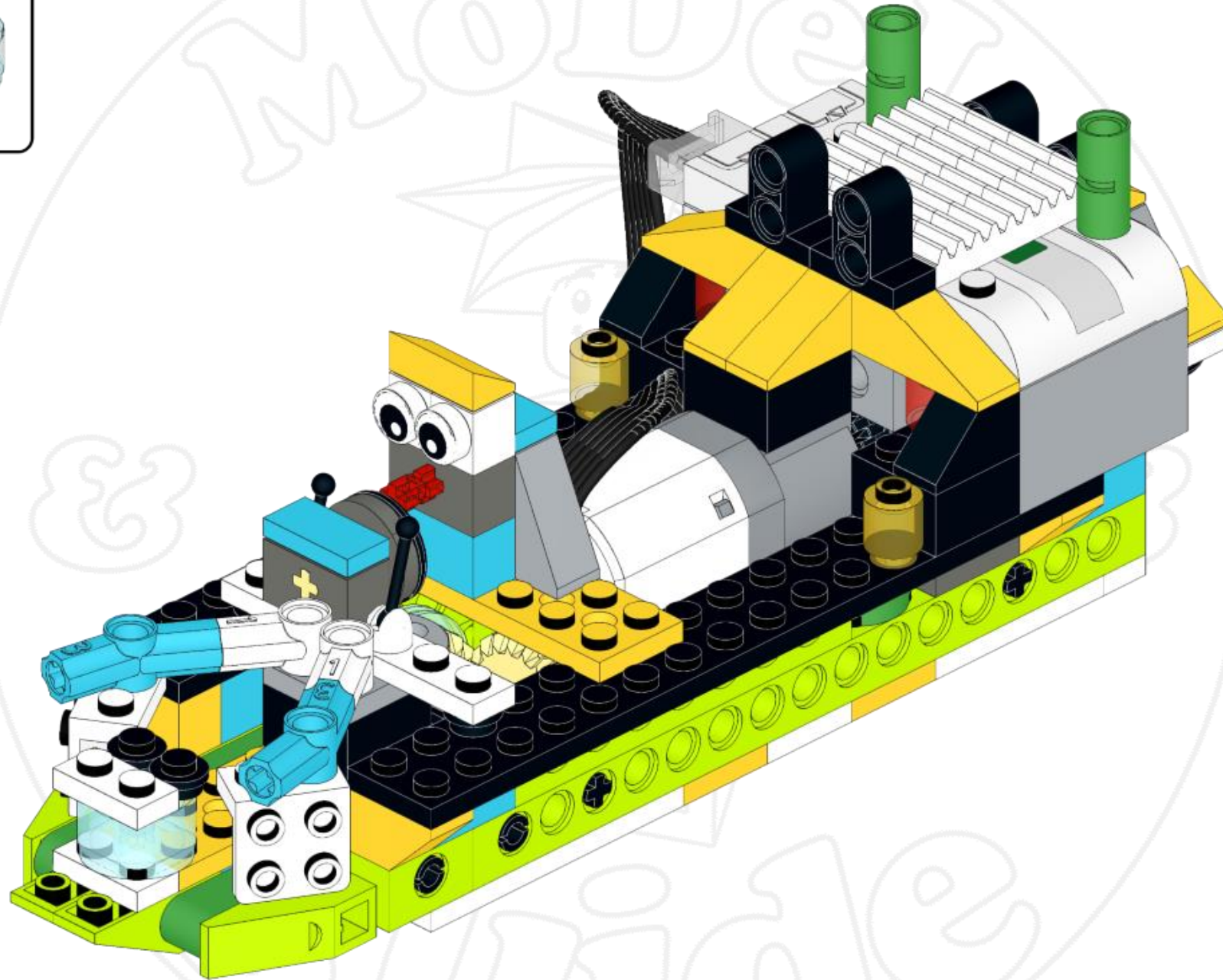
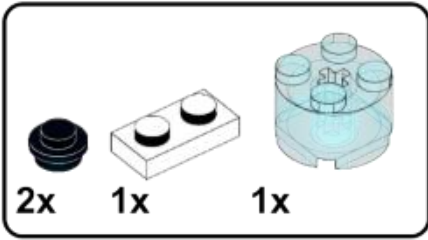

53

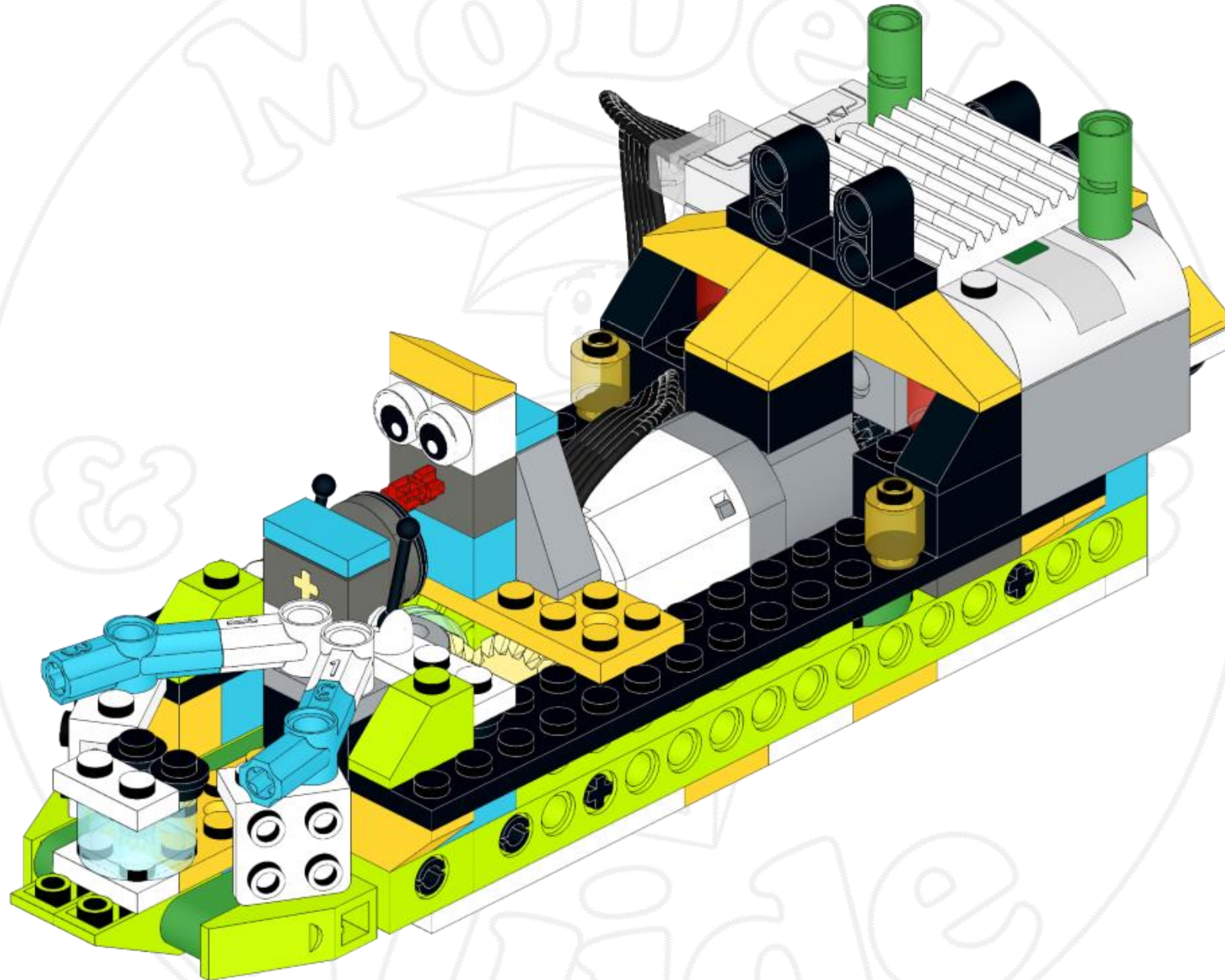
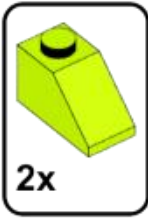

54

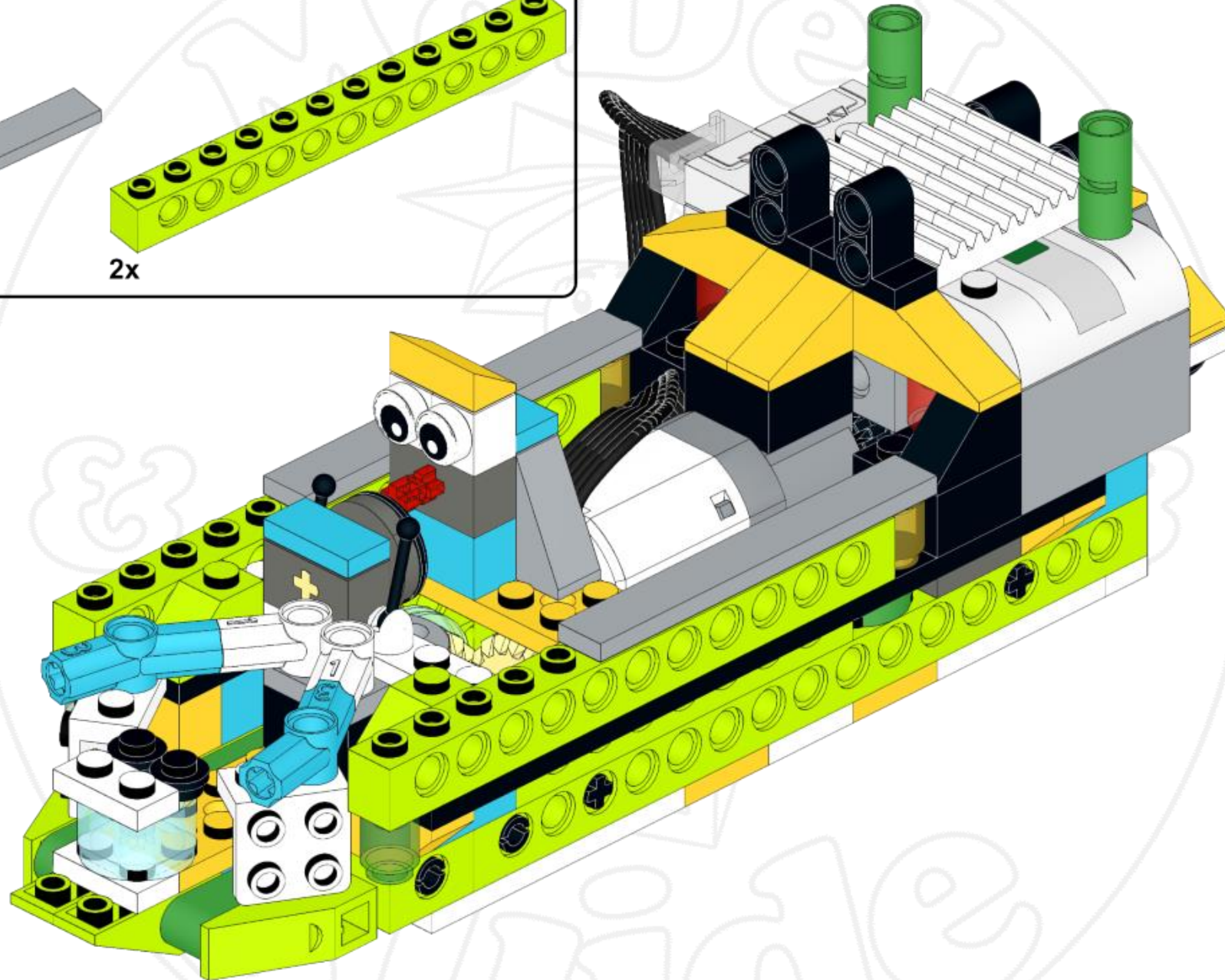
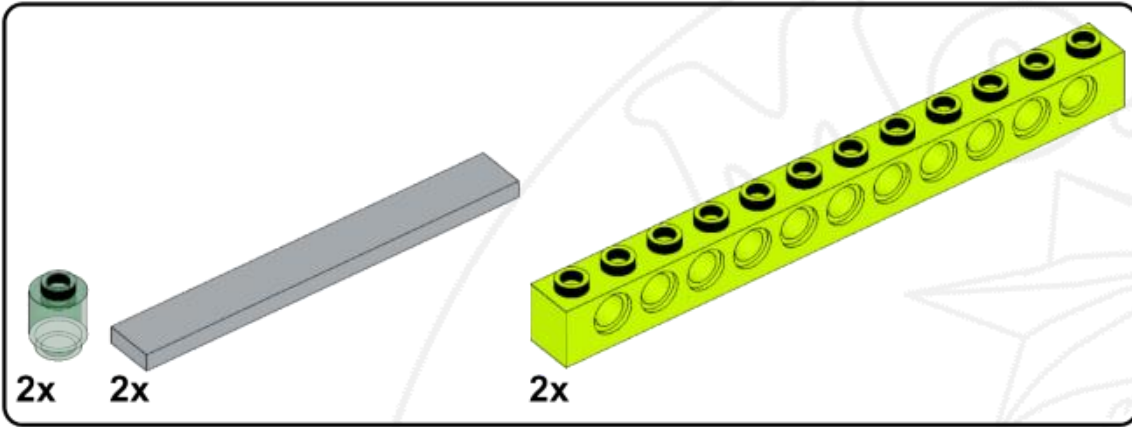

55

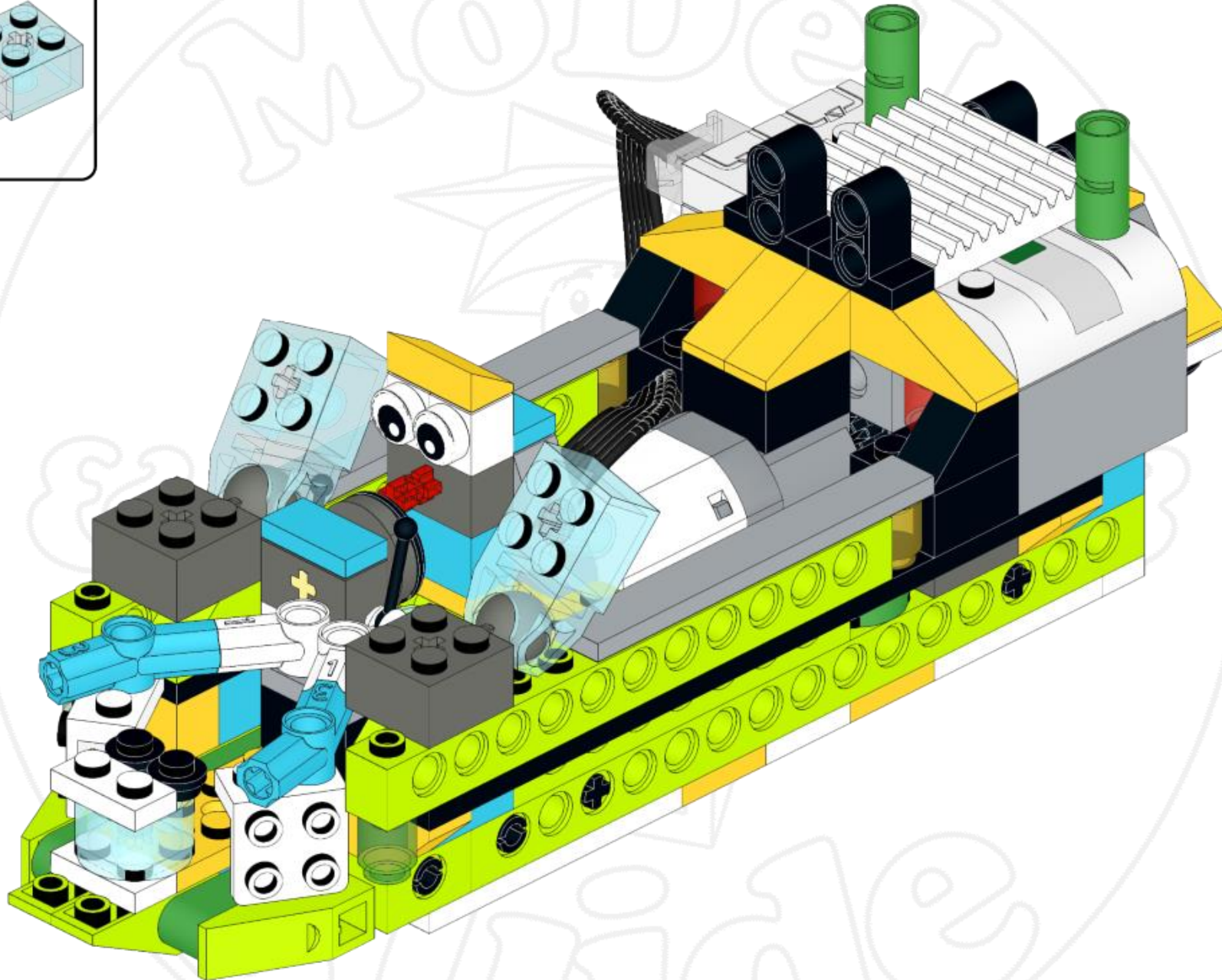
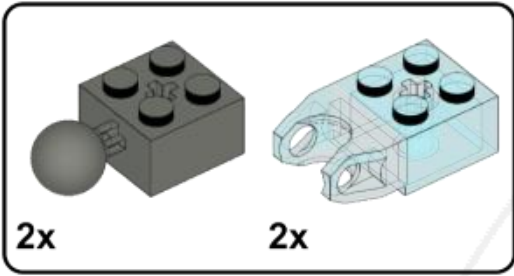



56

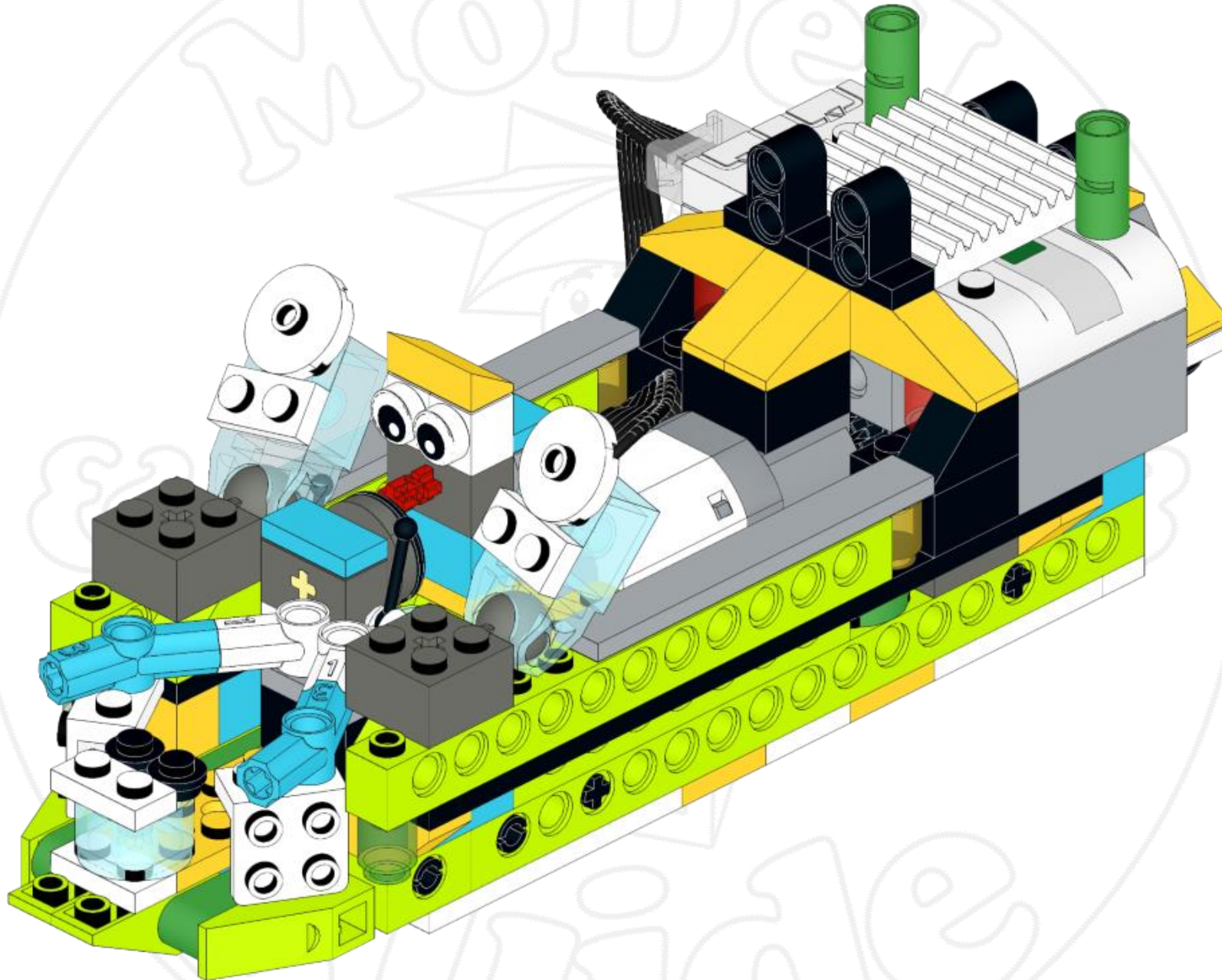
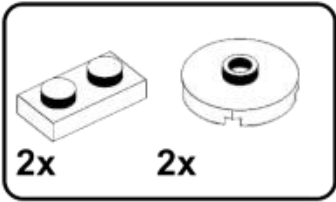

57

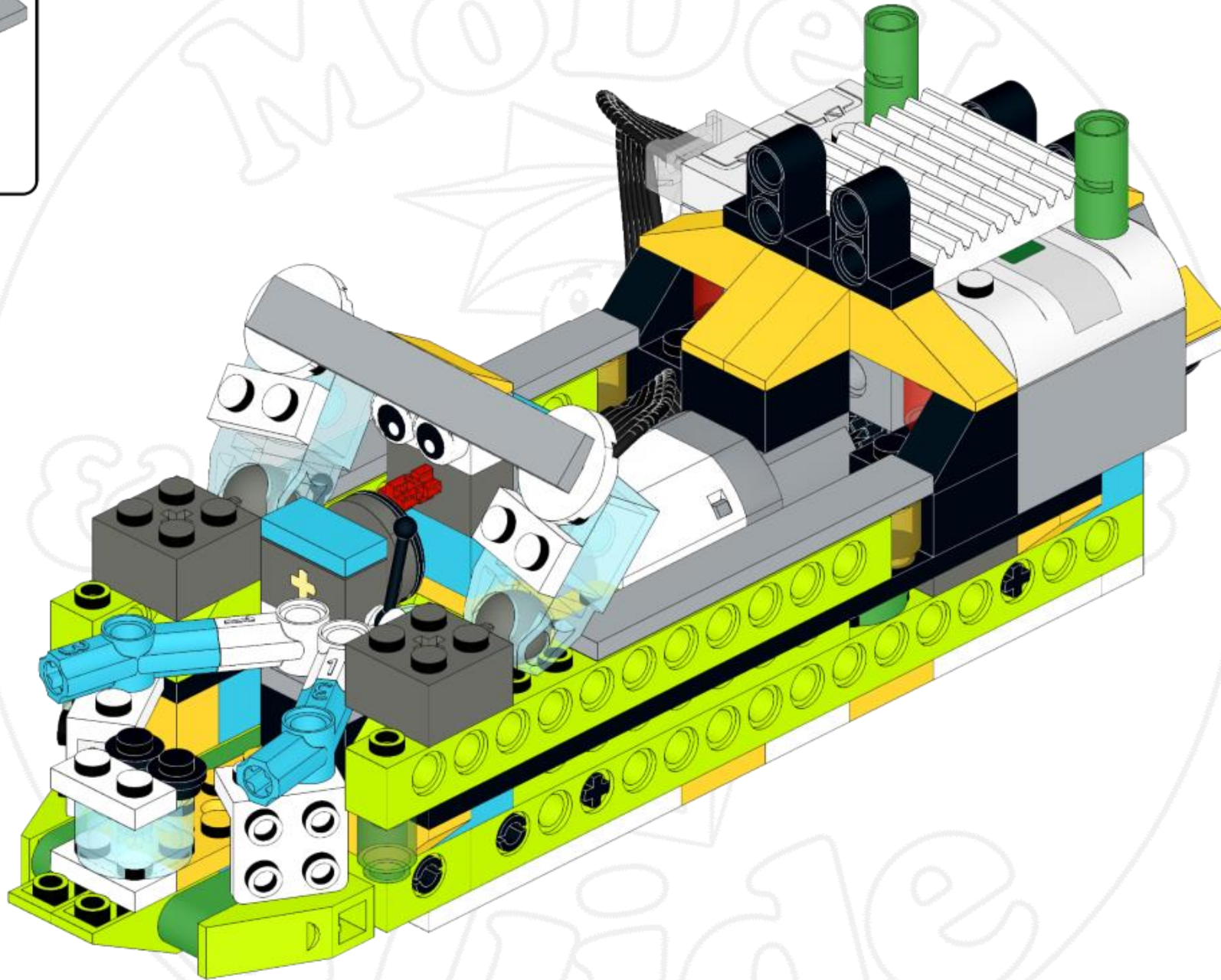
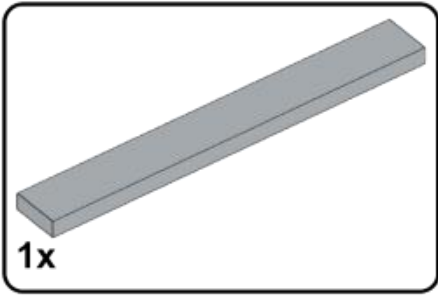

58

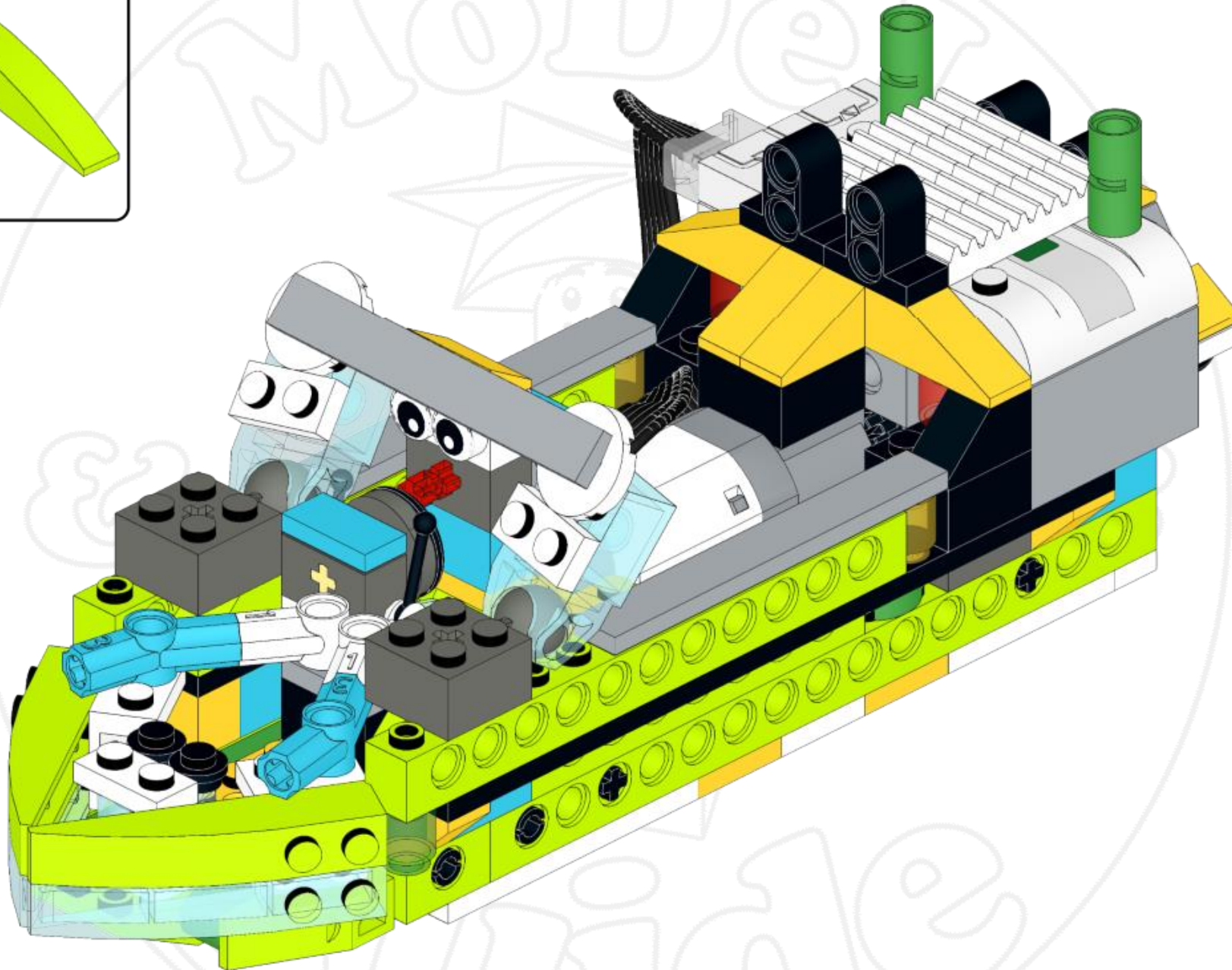
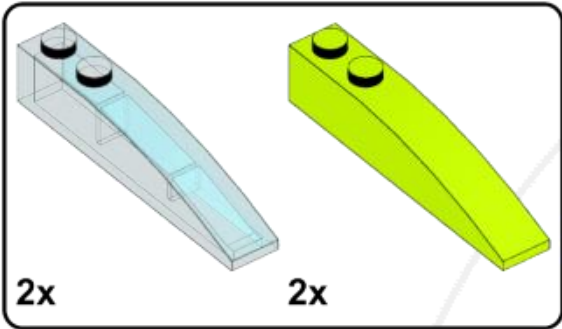

59

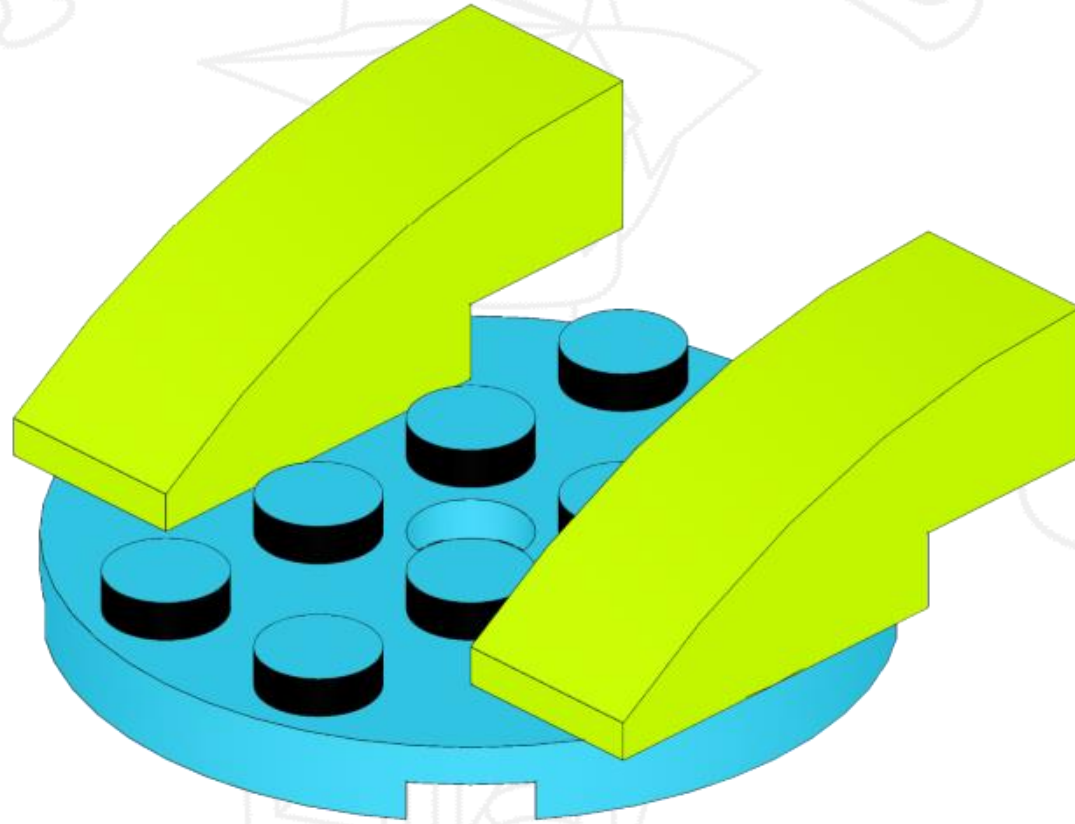
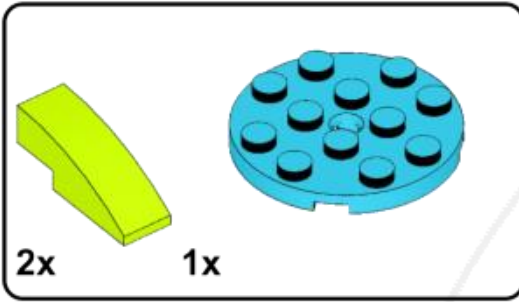

Model  
&  
&  
guide

60

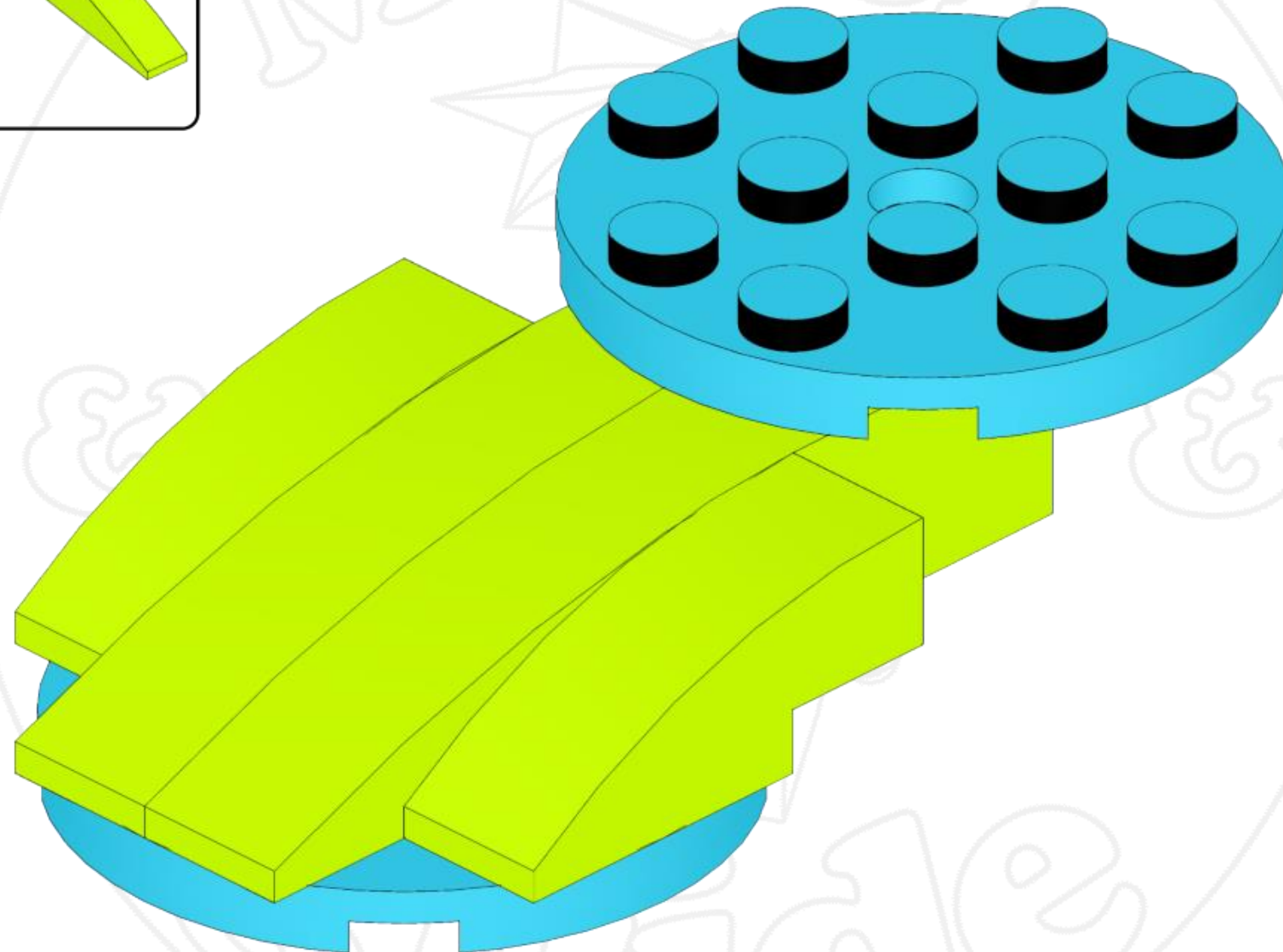
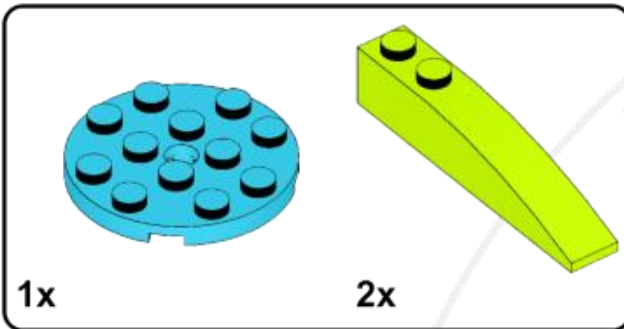

61

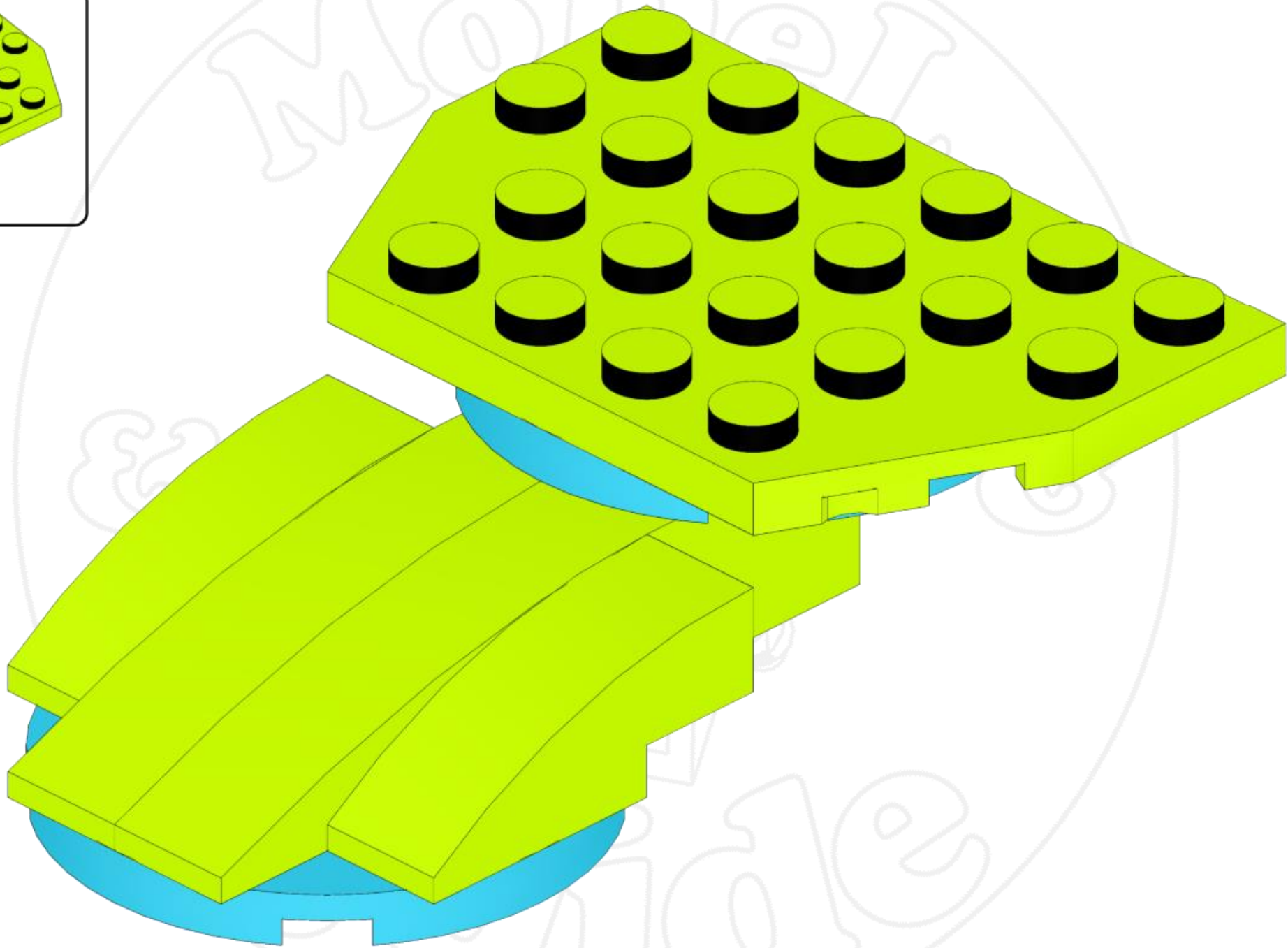
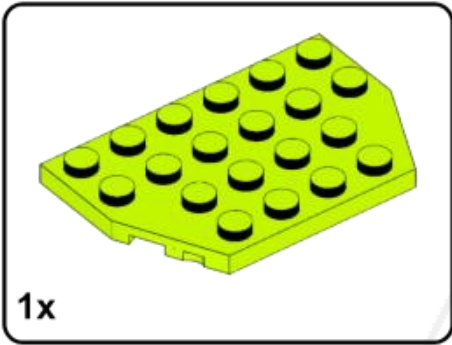

62

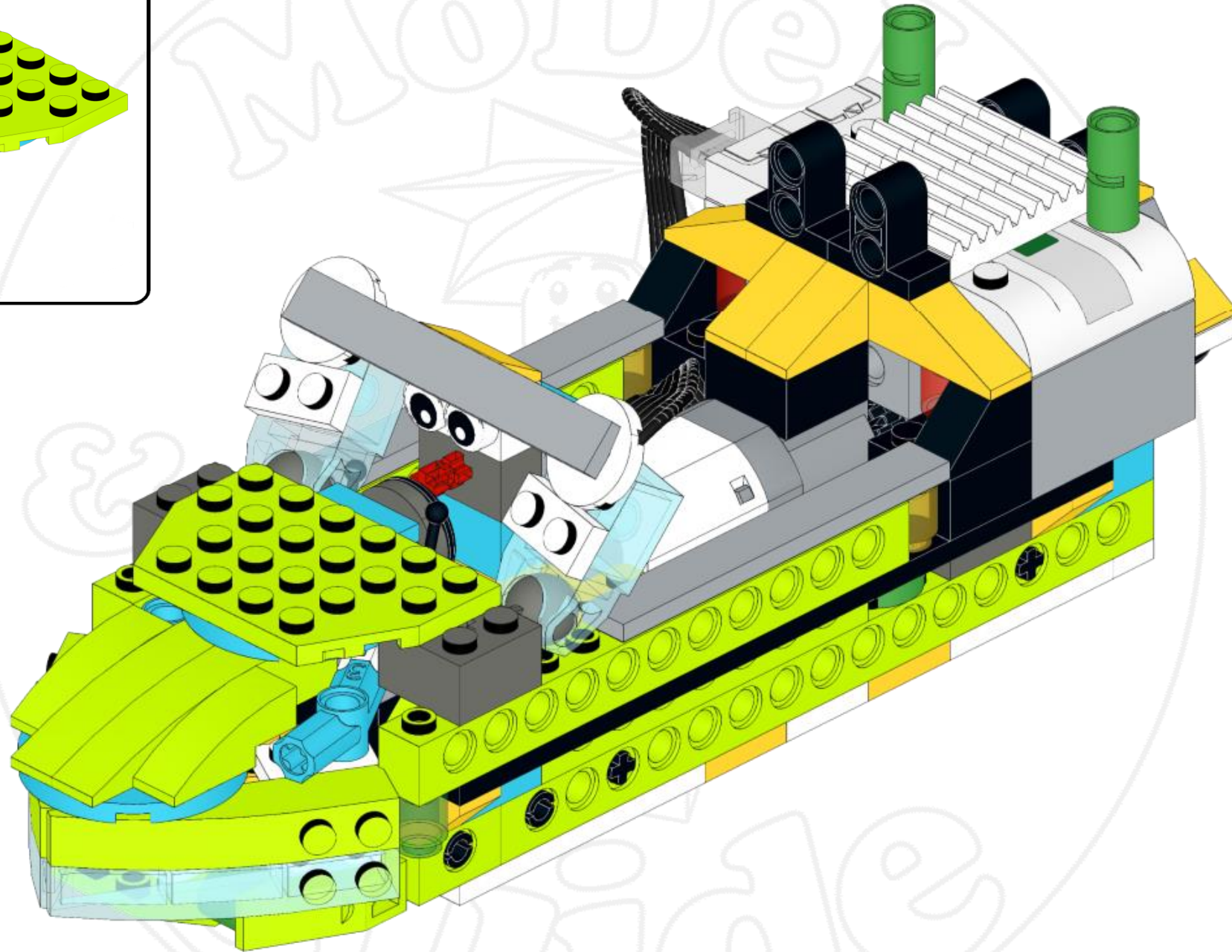
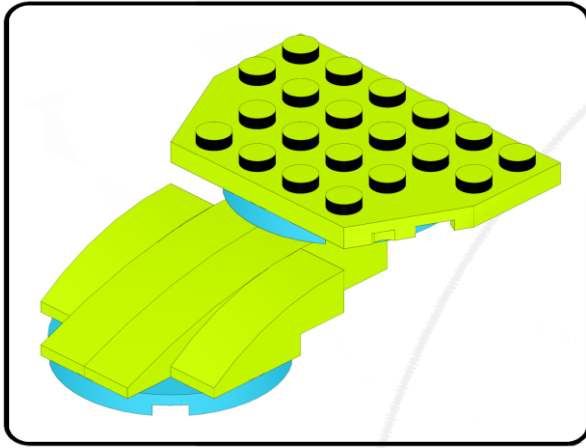

63

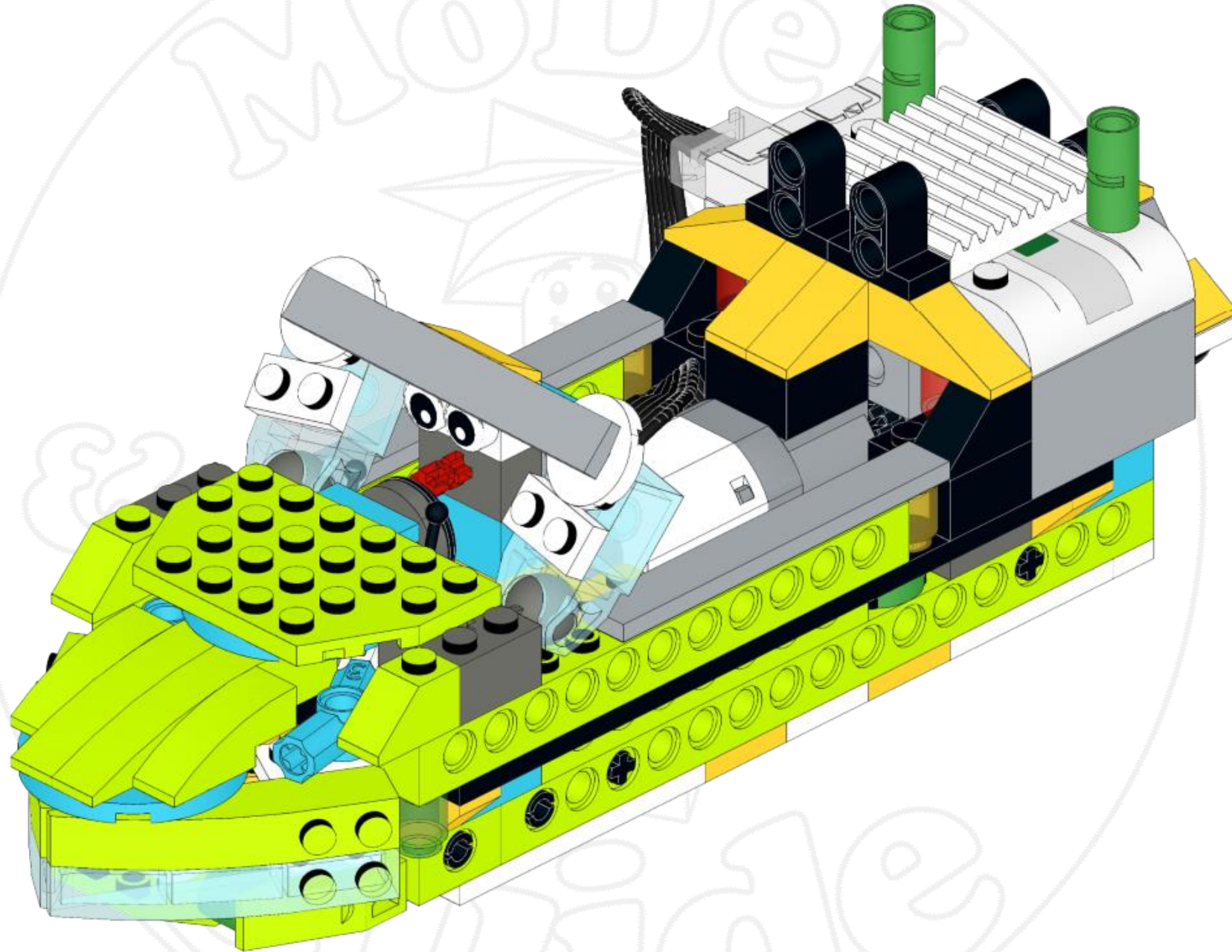
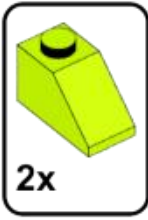



64

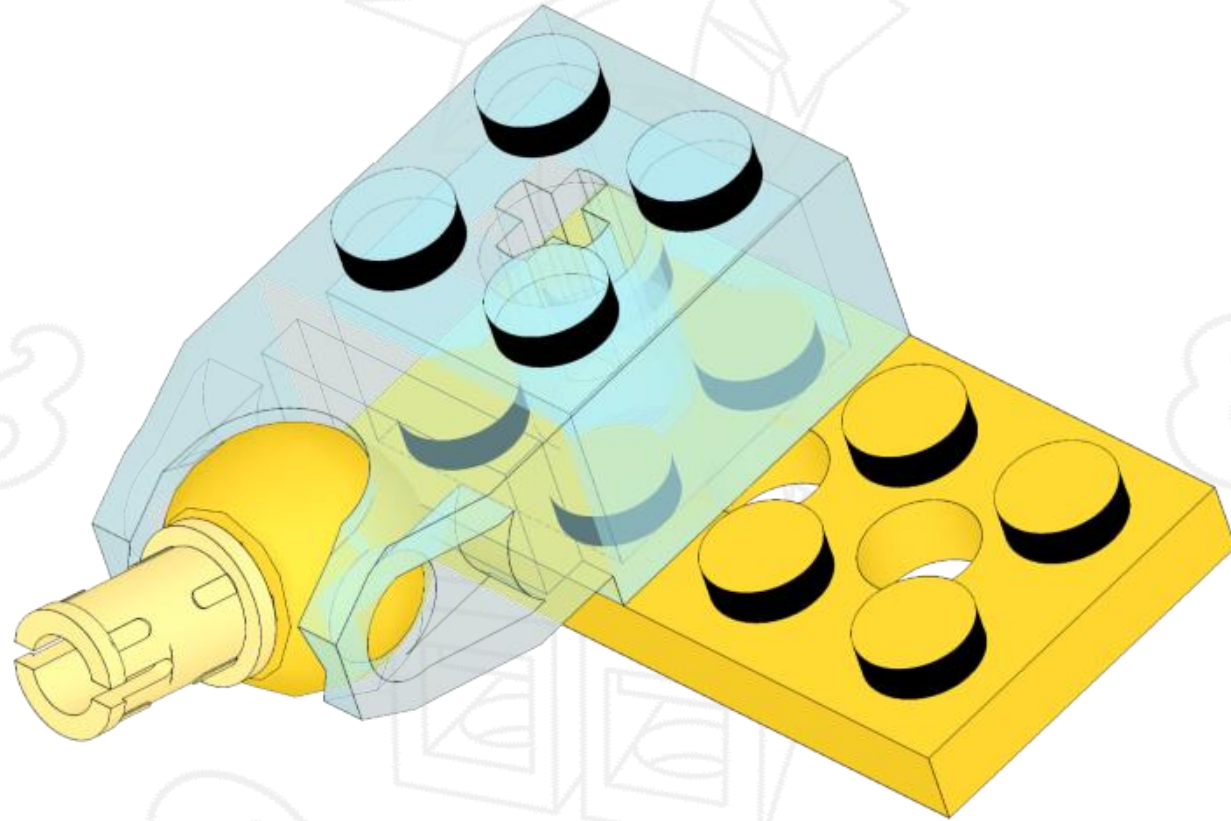
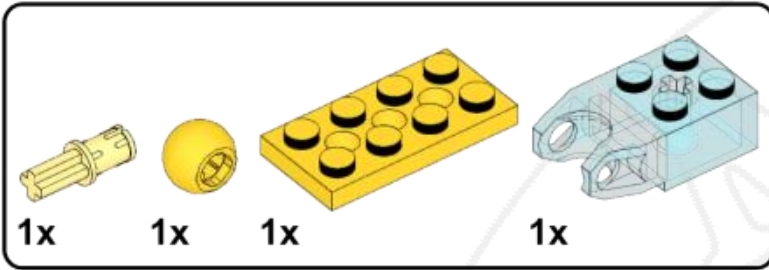

65

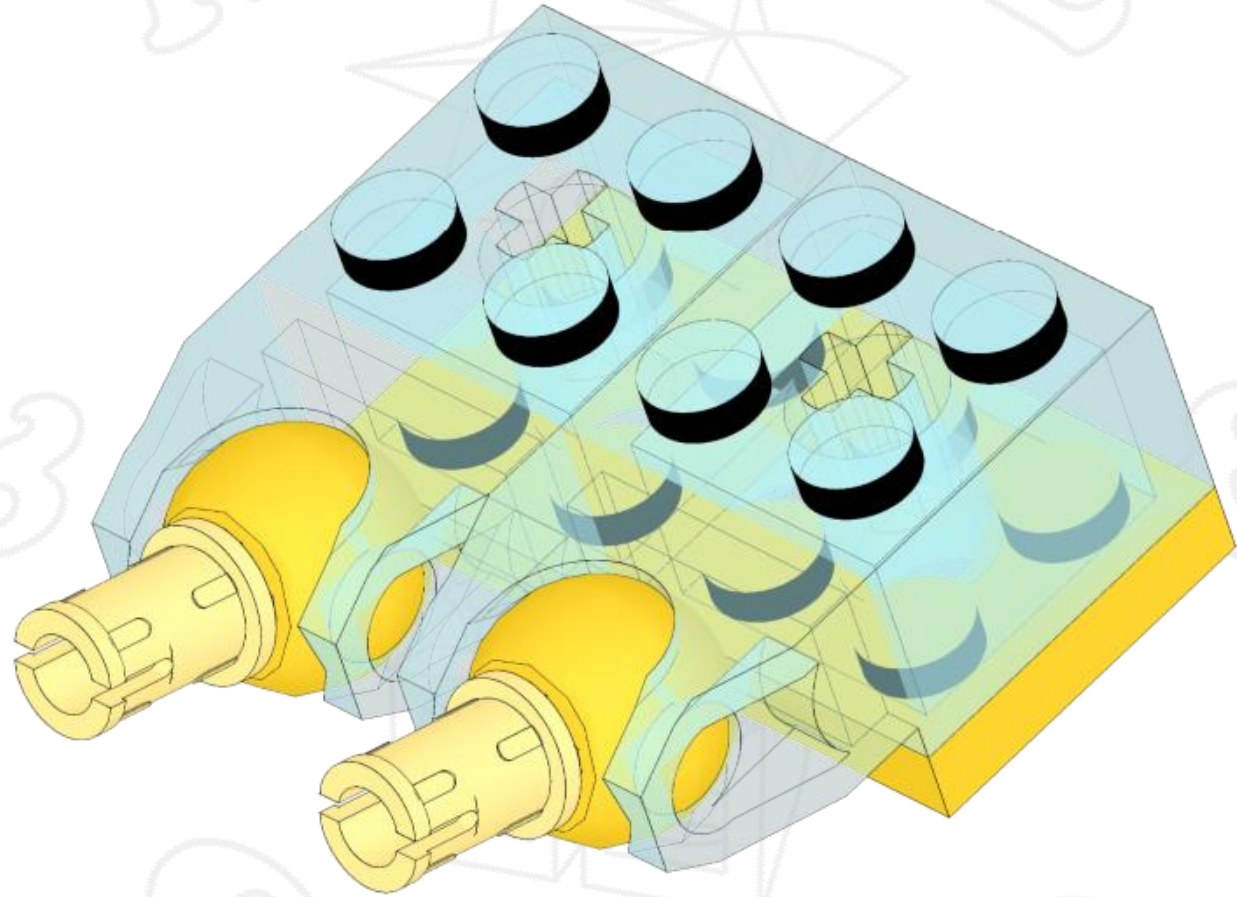
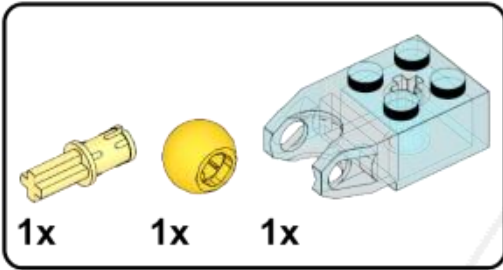

Model  
& Guide

66

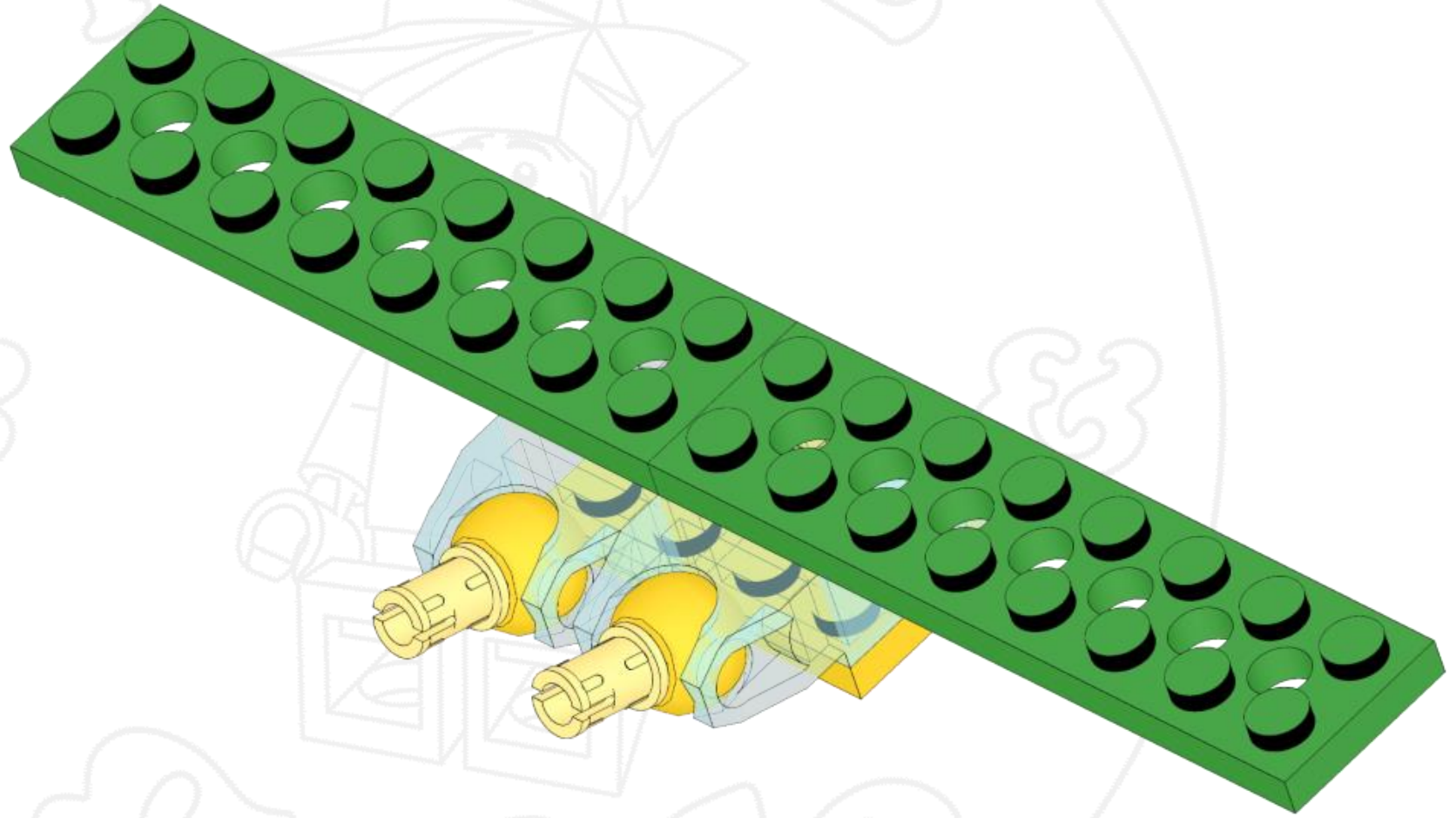
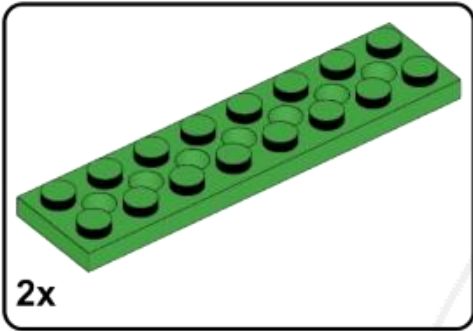

Model  
&  
Guide

67

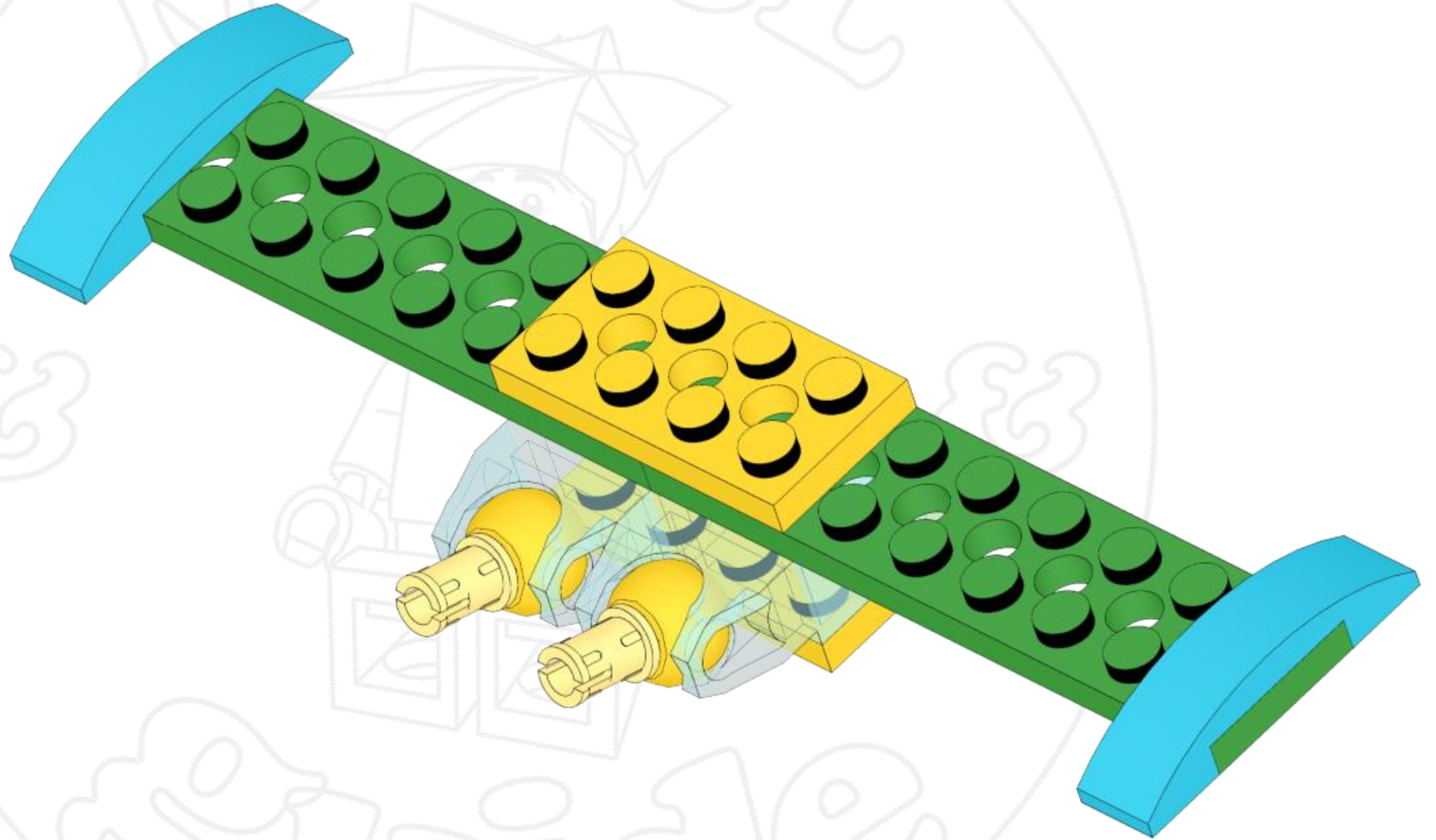
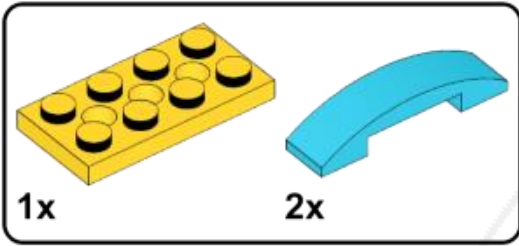

68

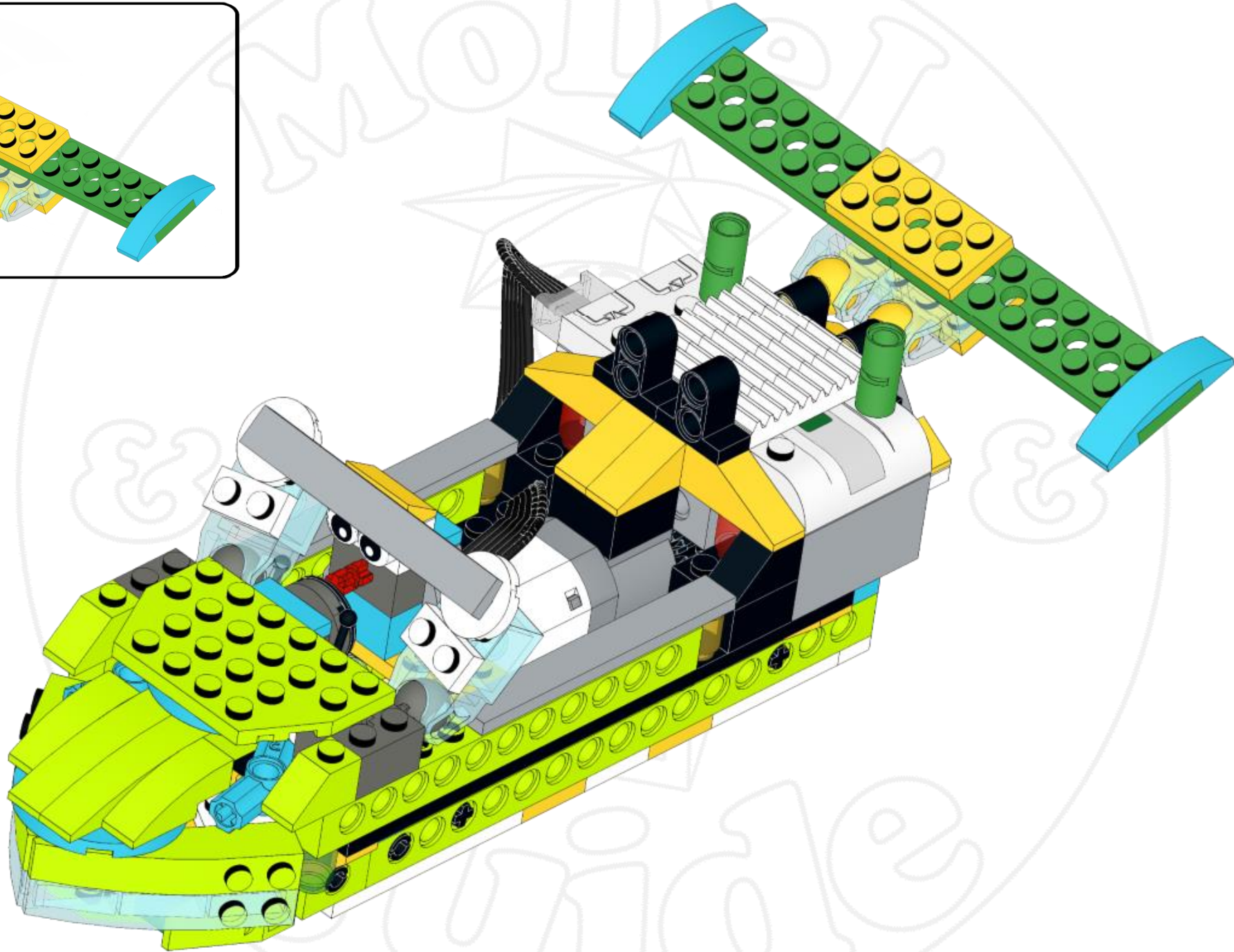
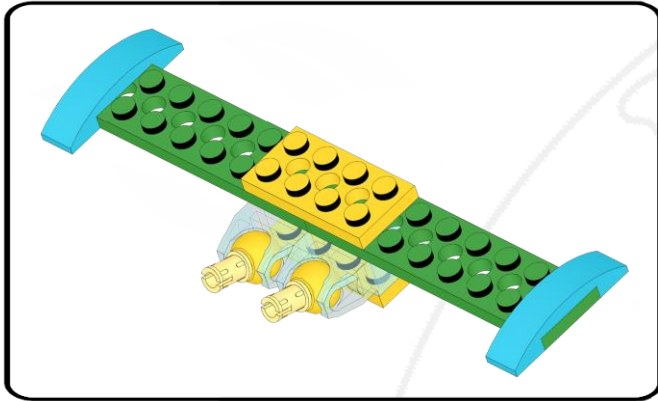

Model



	9	1	7	1	5	1	10		7	5	

guide

