

CV1

Road Roller



SN: CV1-20022021

www.patreon.com/user?u=31204492

Instruction

1

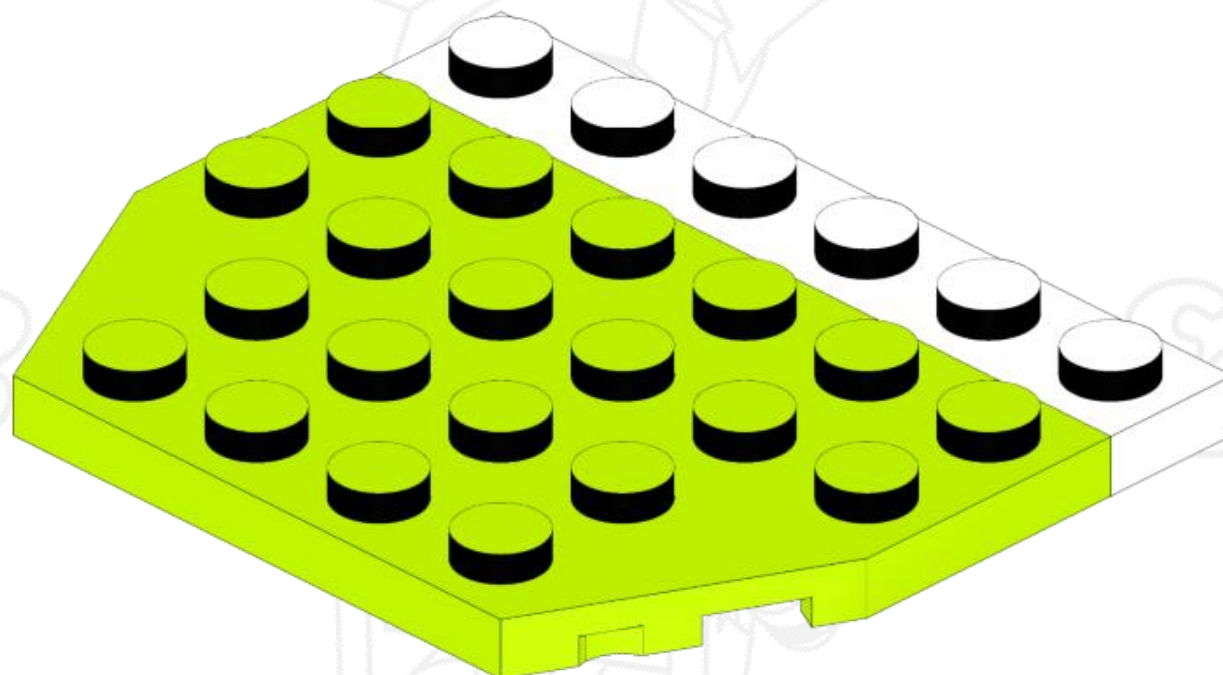
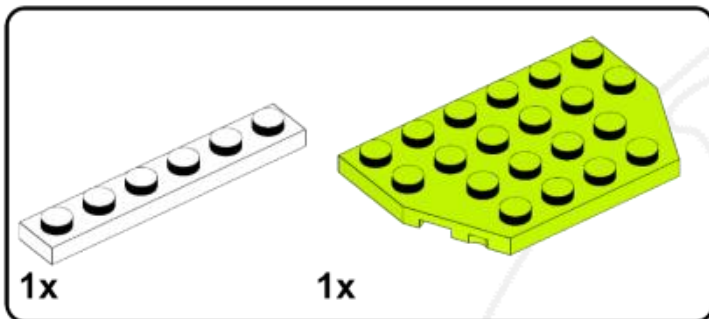

Model

Build

2

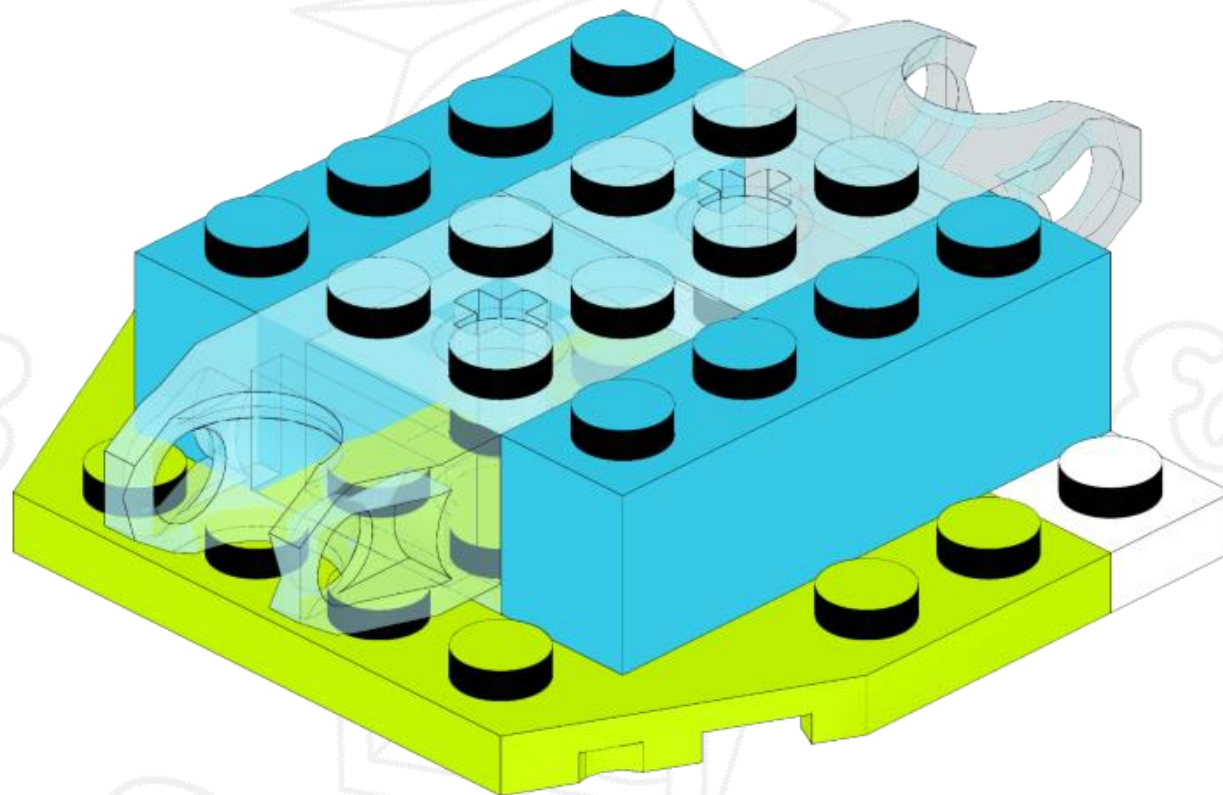
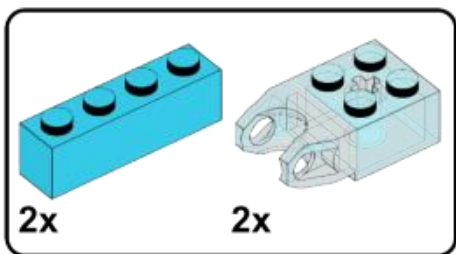

Model & Guide

3

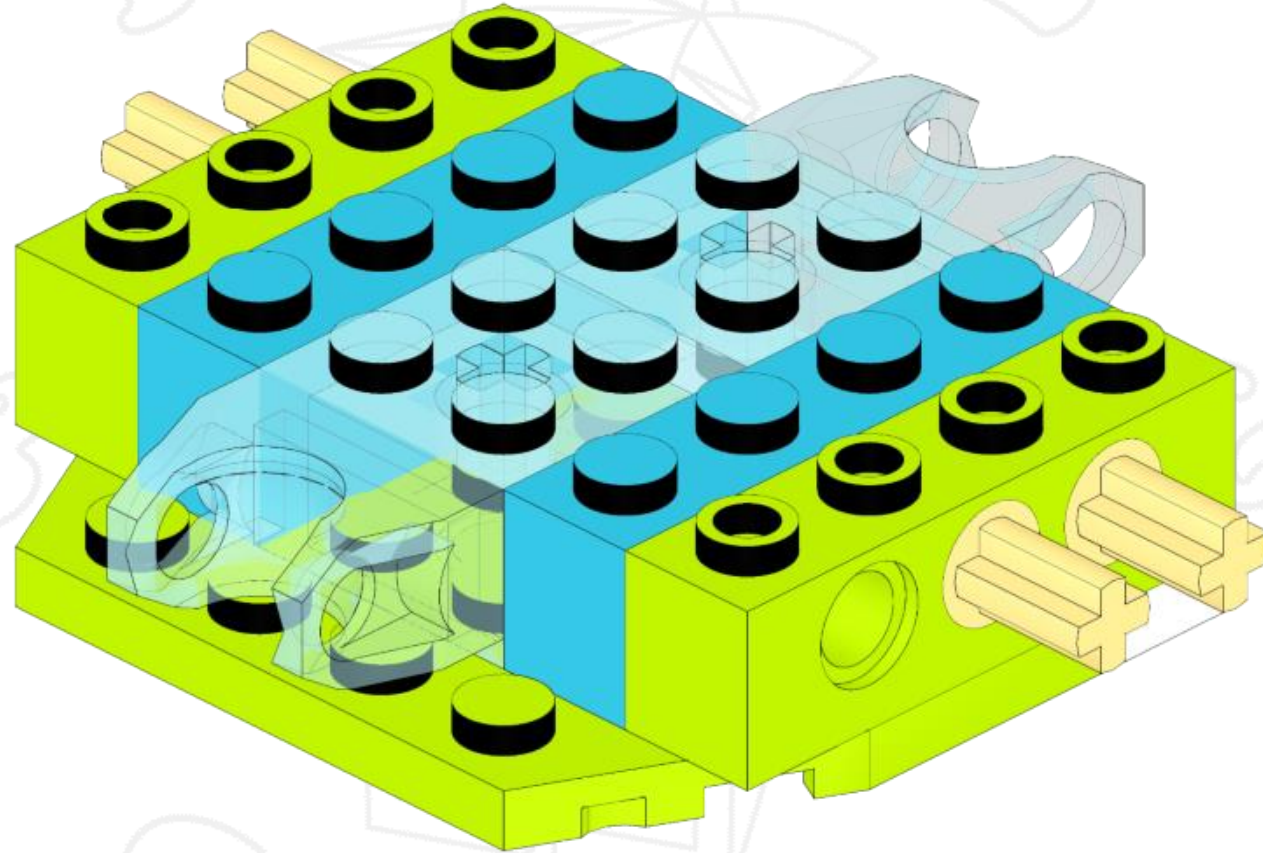
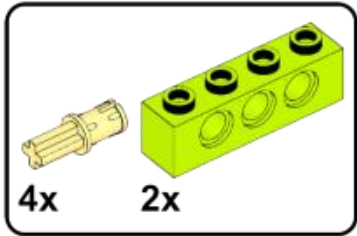

4

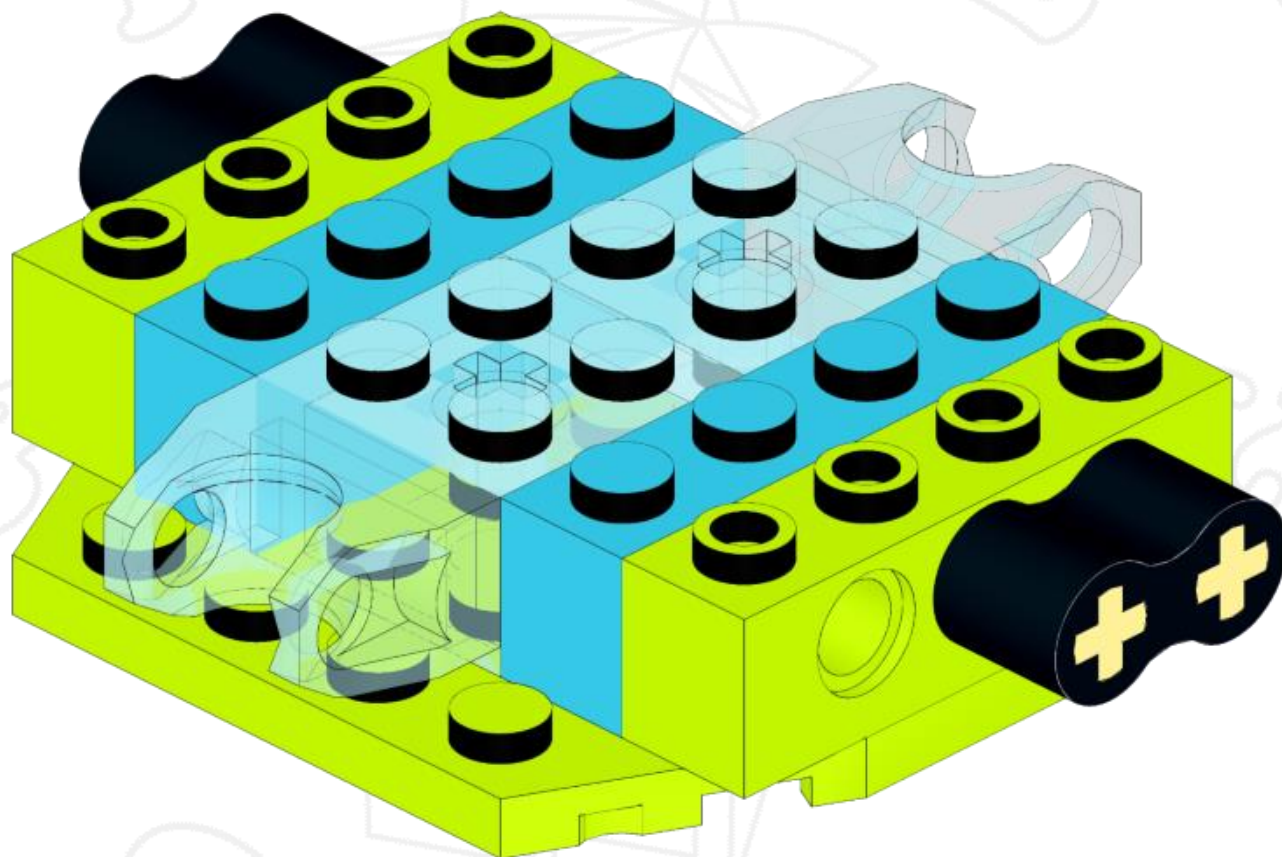

5

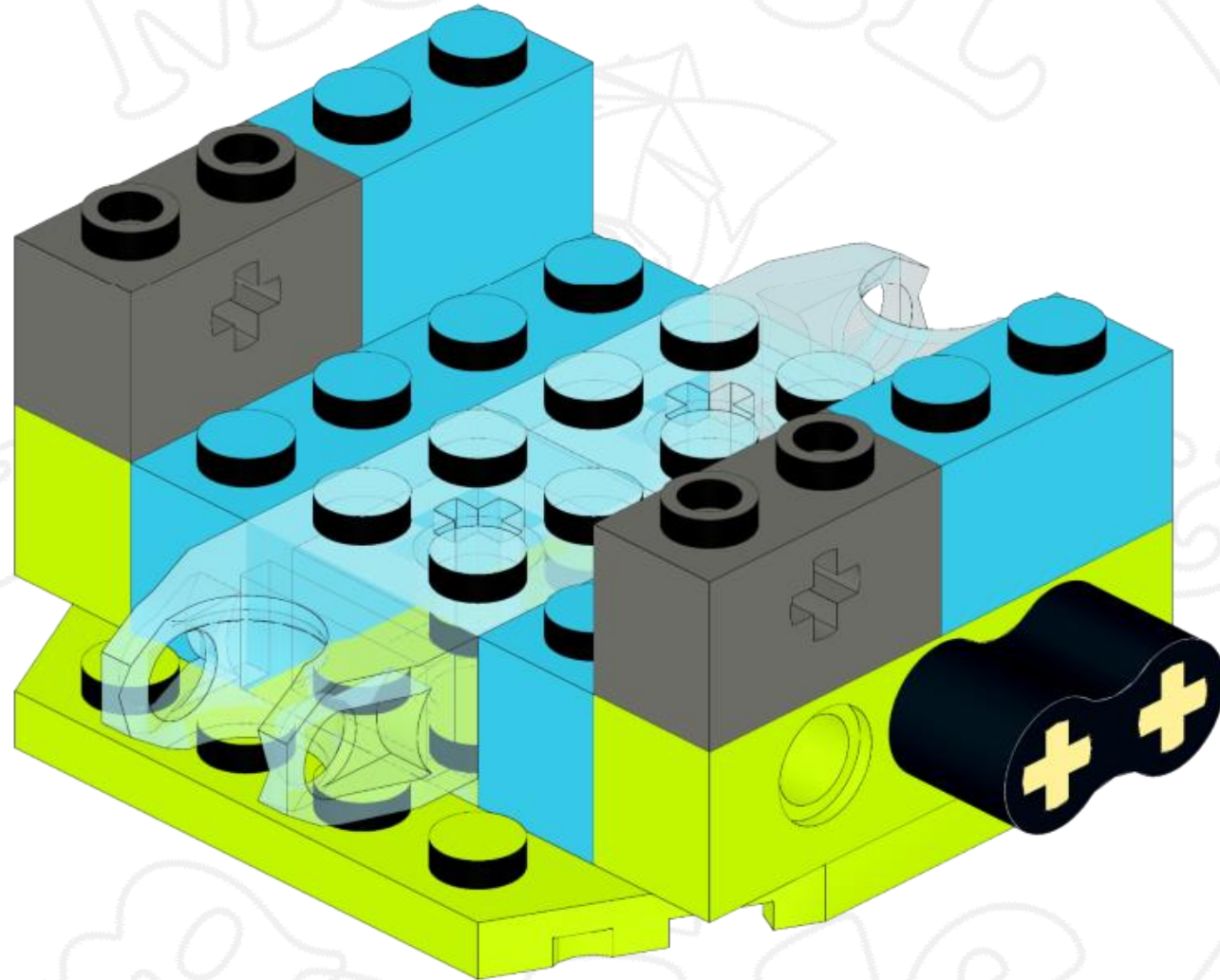
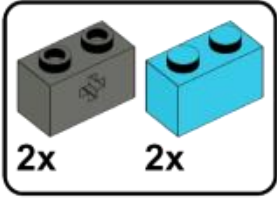

6

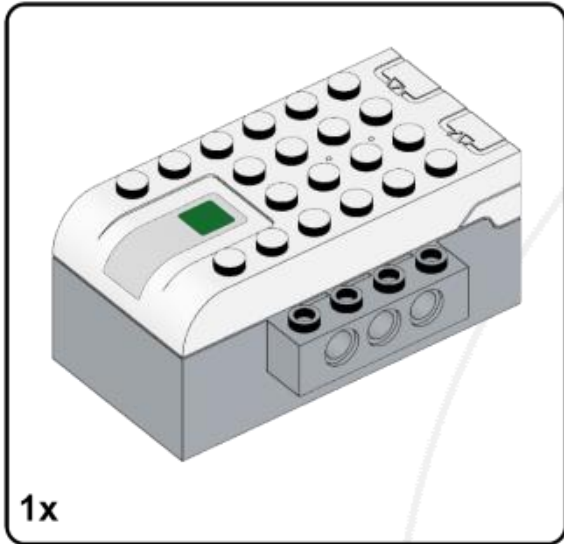

7

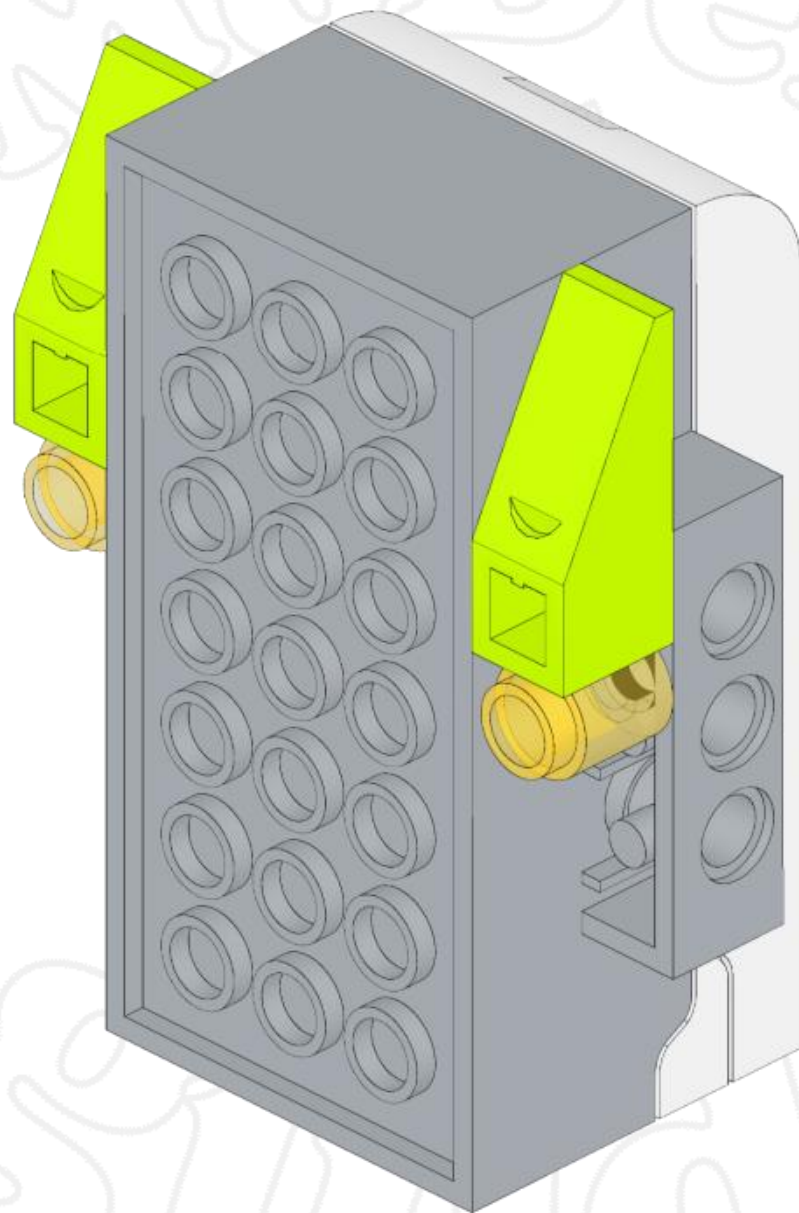
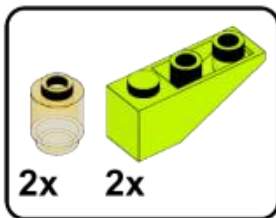

8

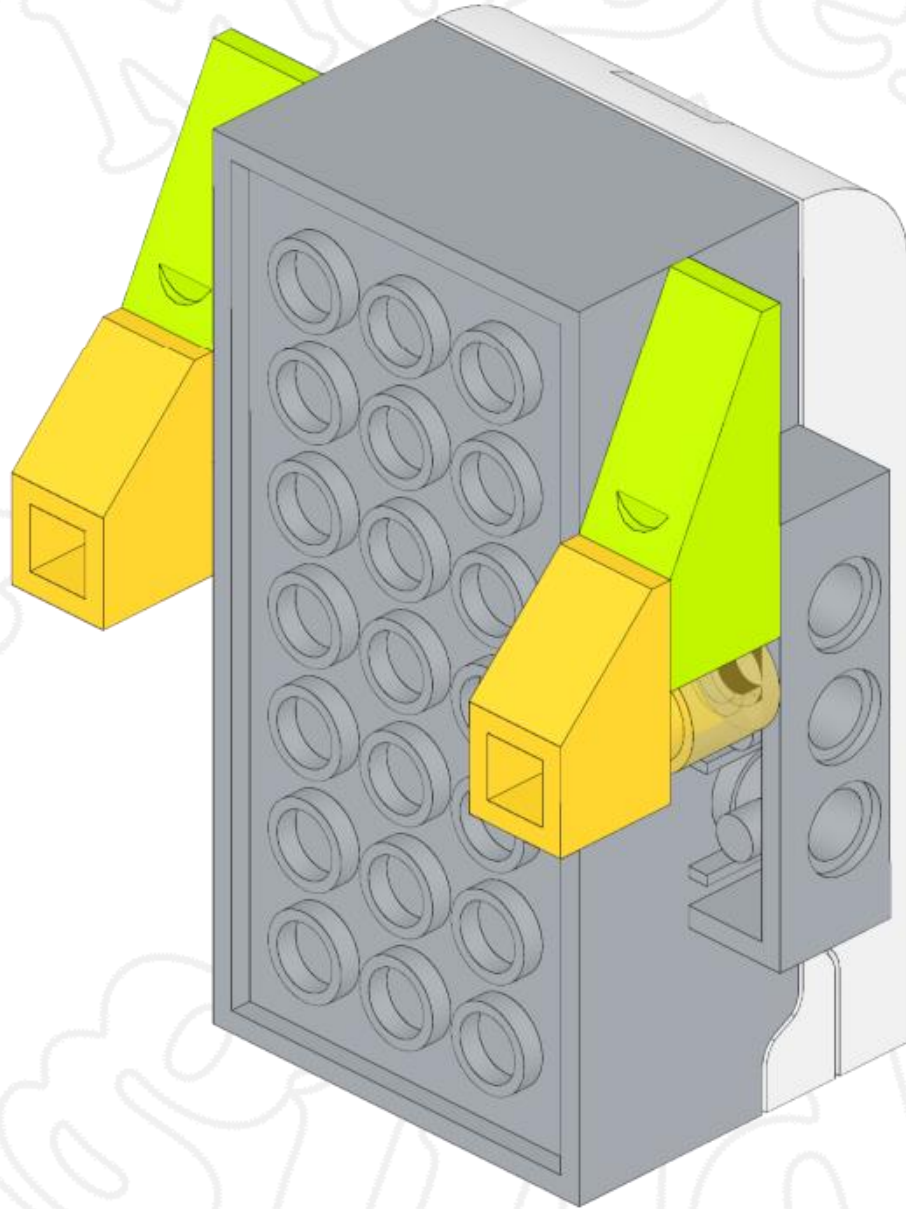
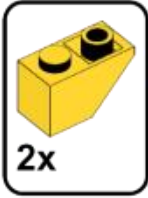

9

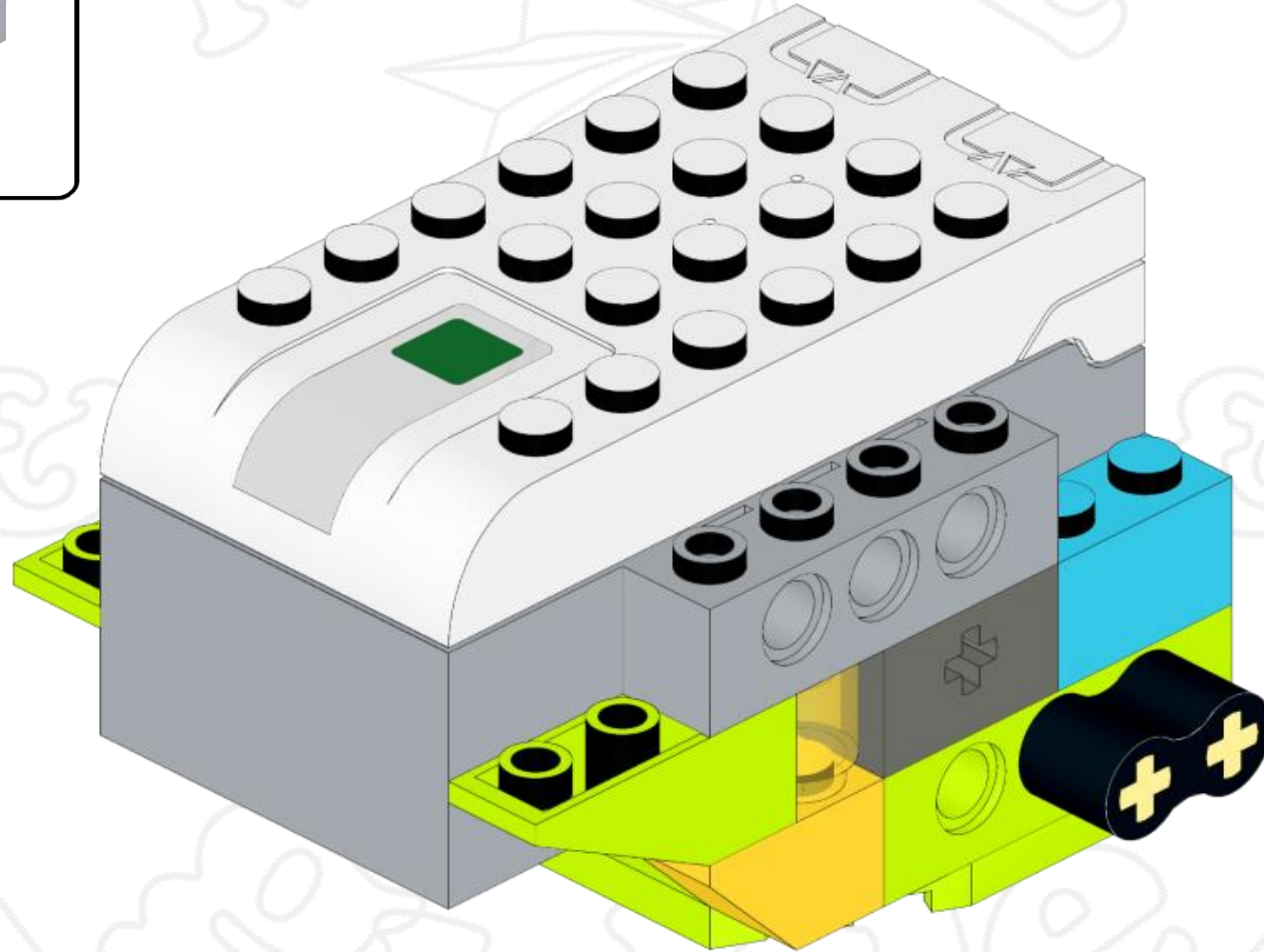
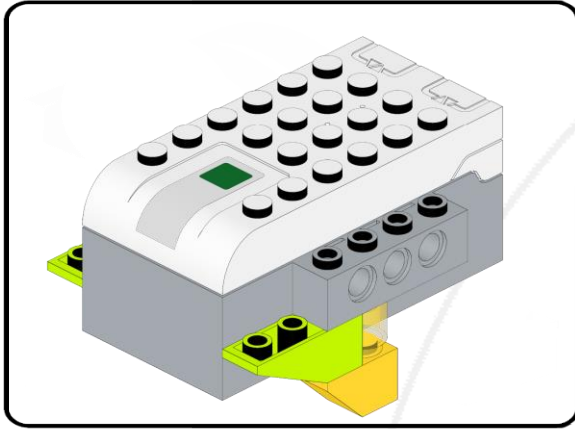

10

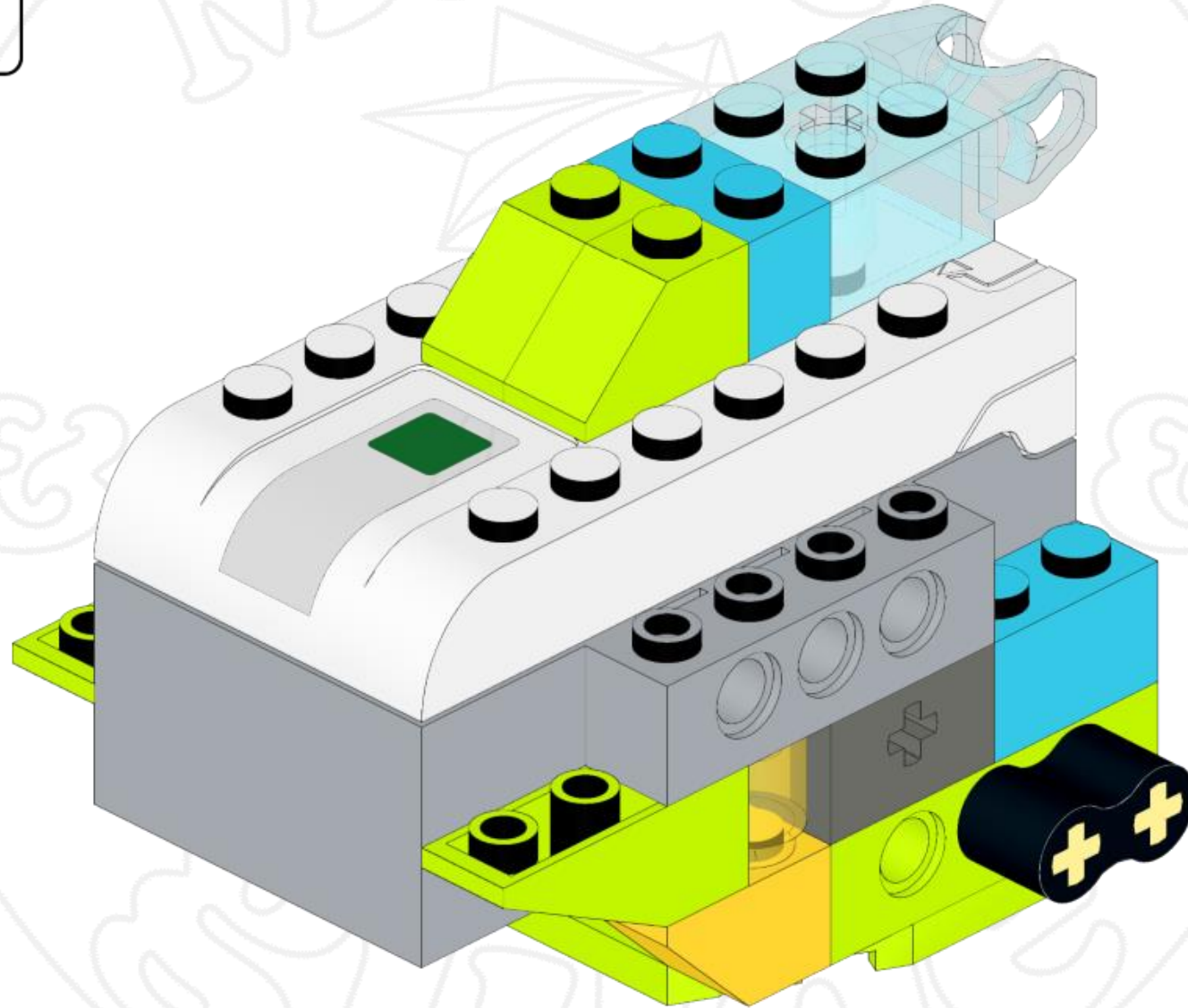
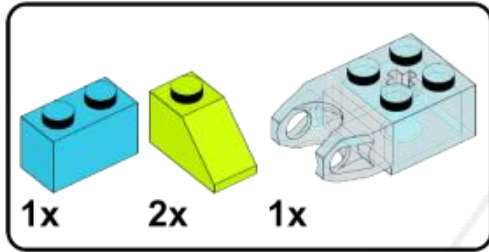

12

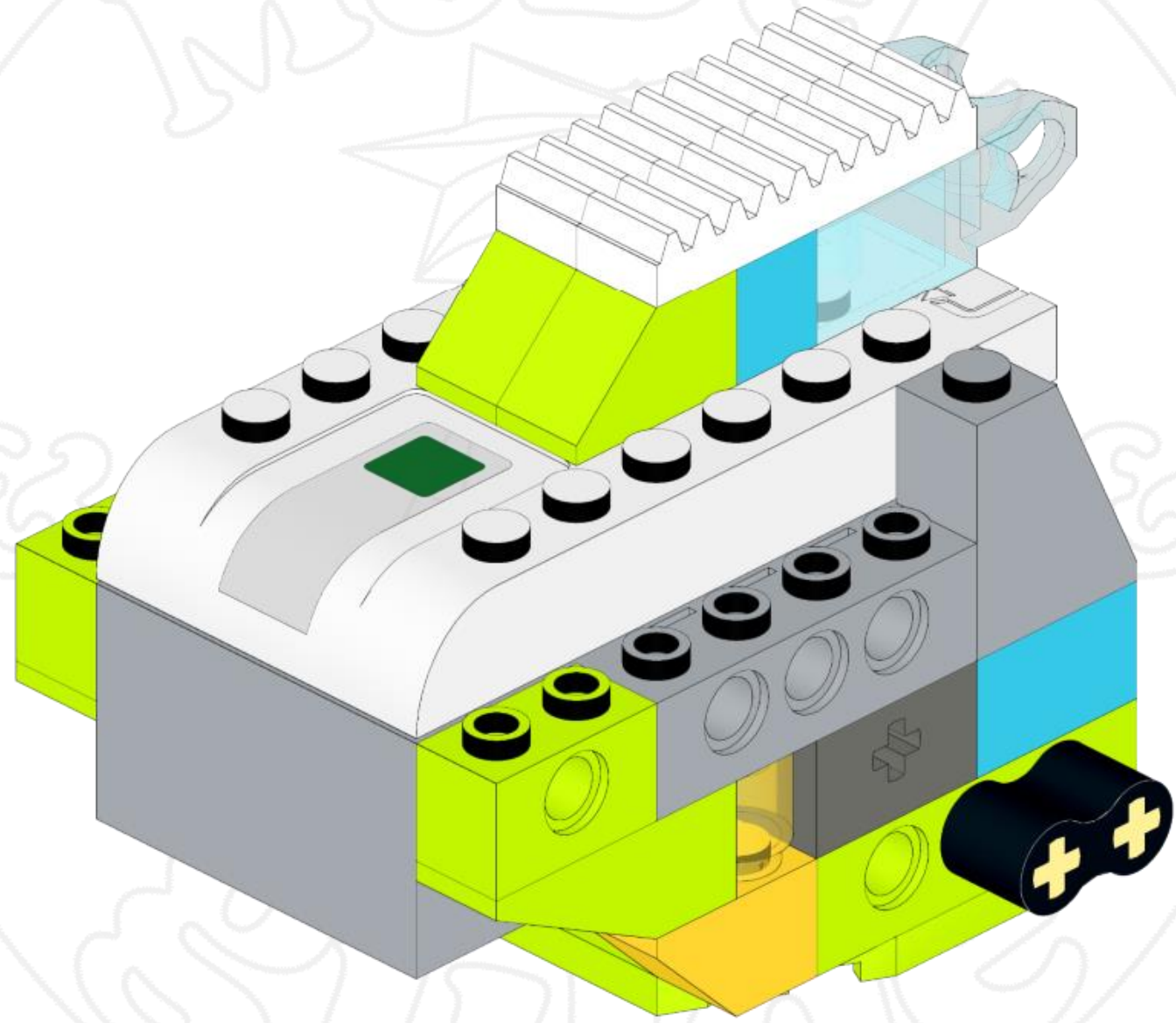
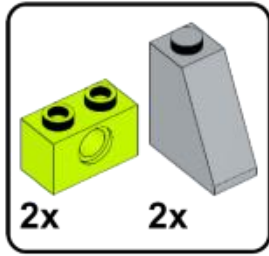

13

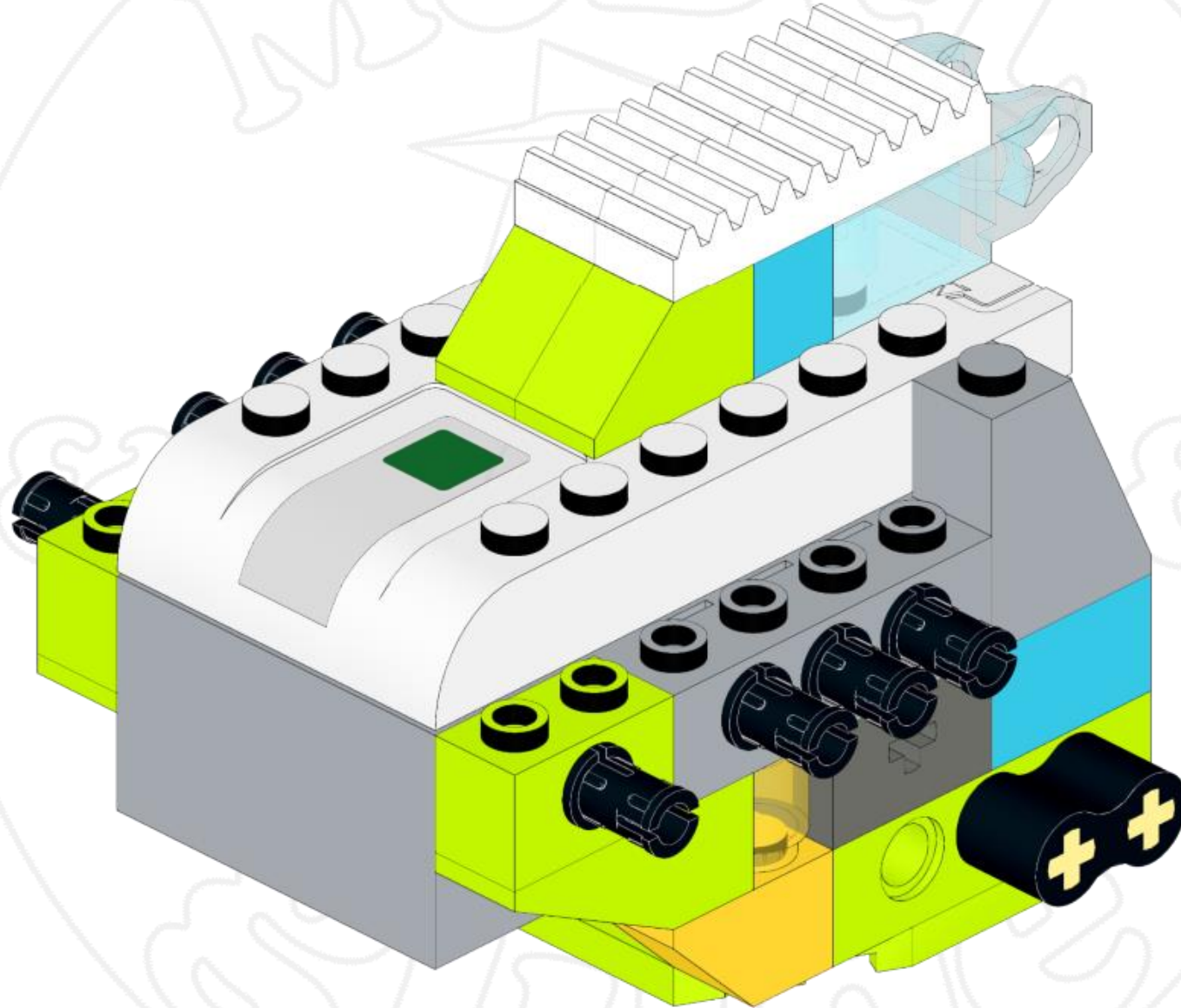

14

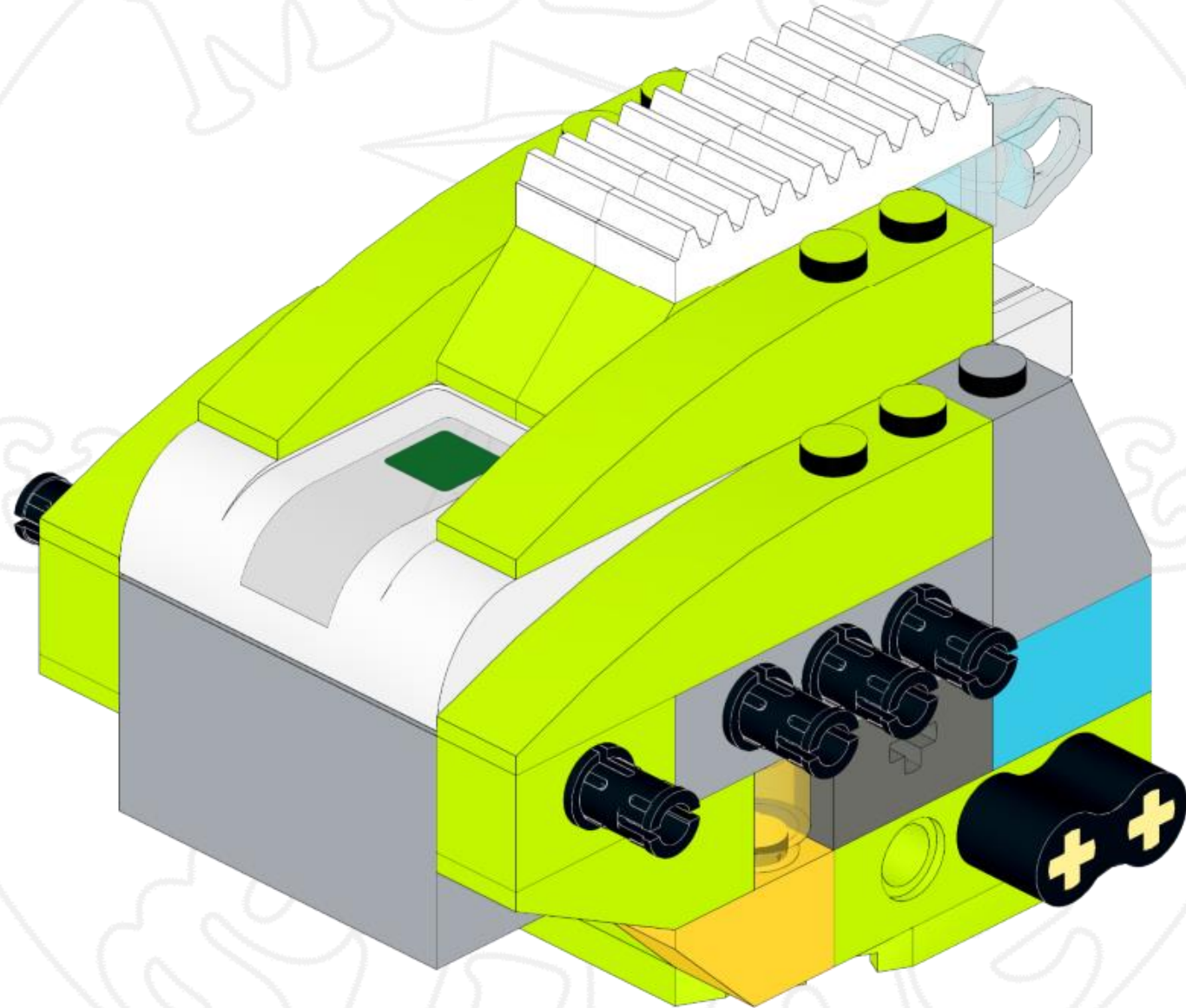
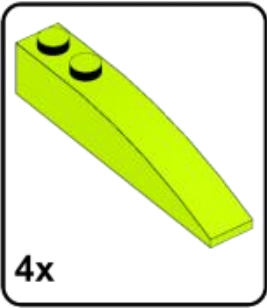

15

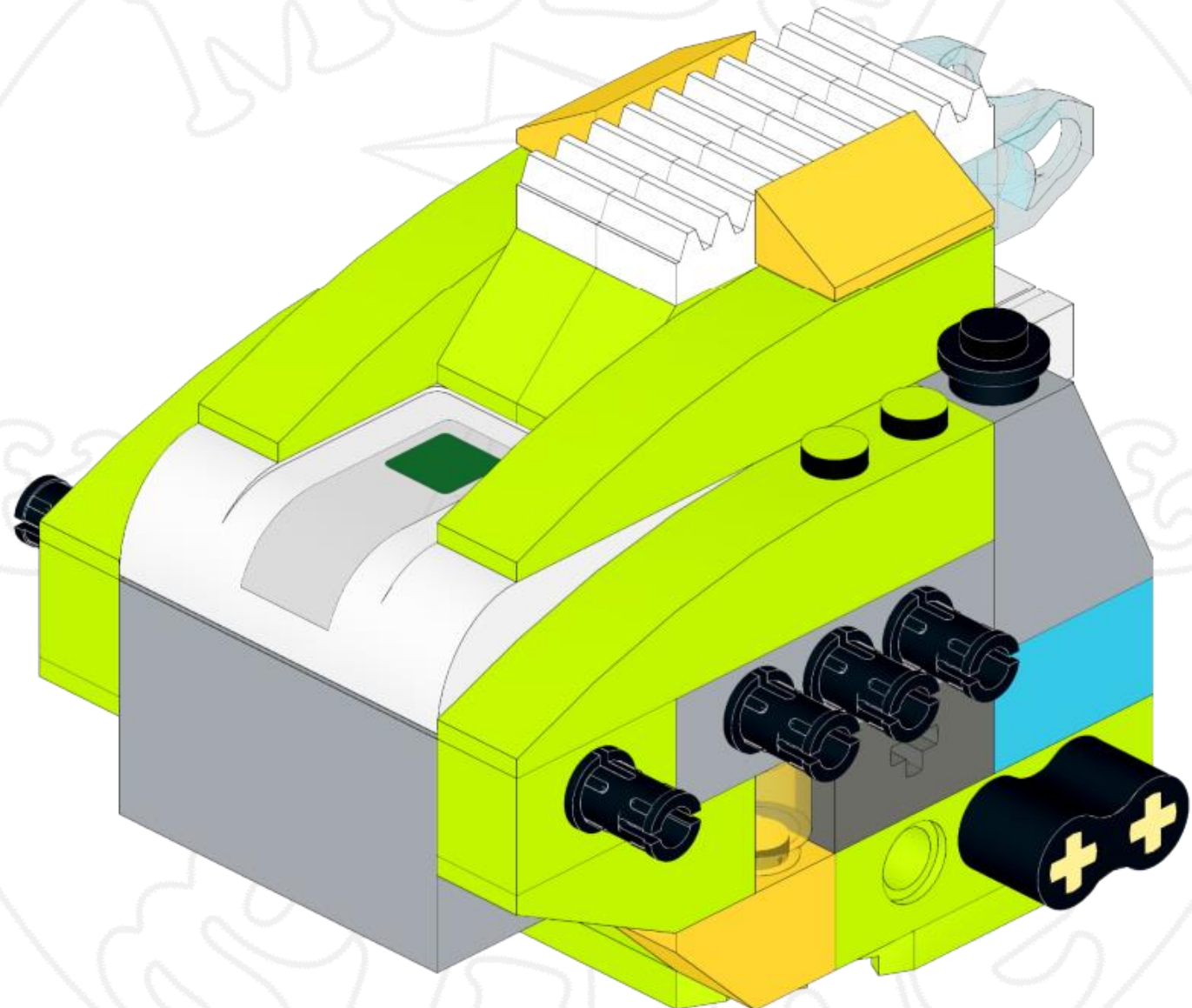
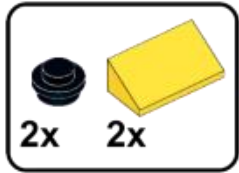

16

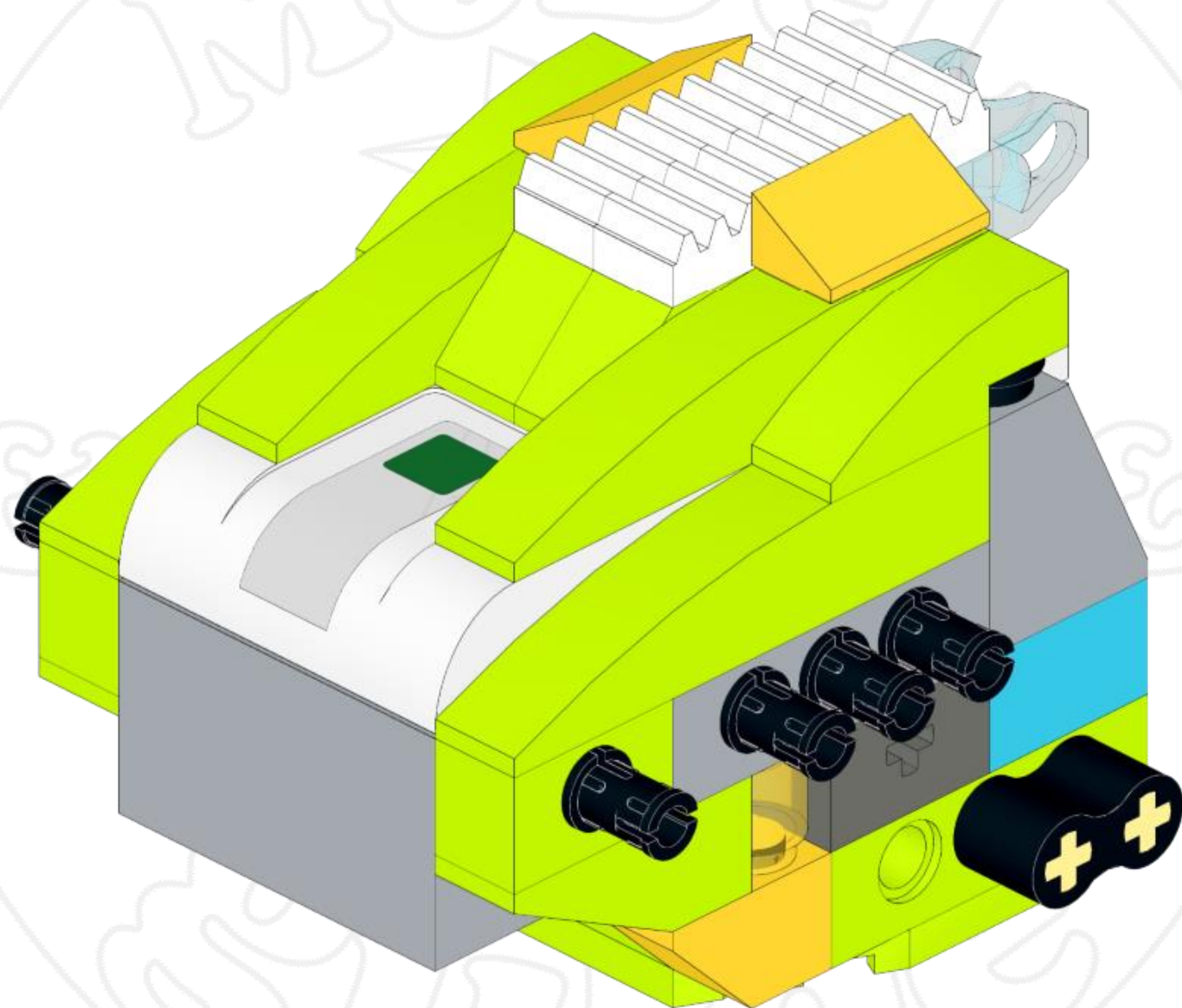
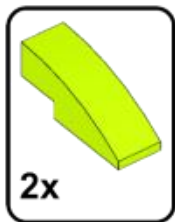

17

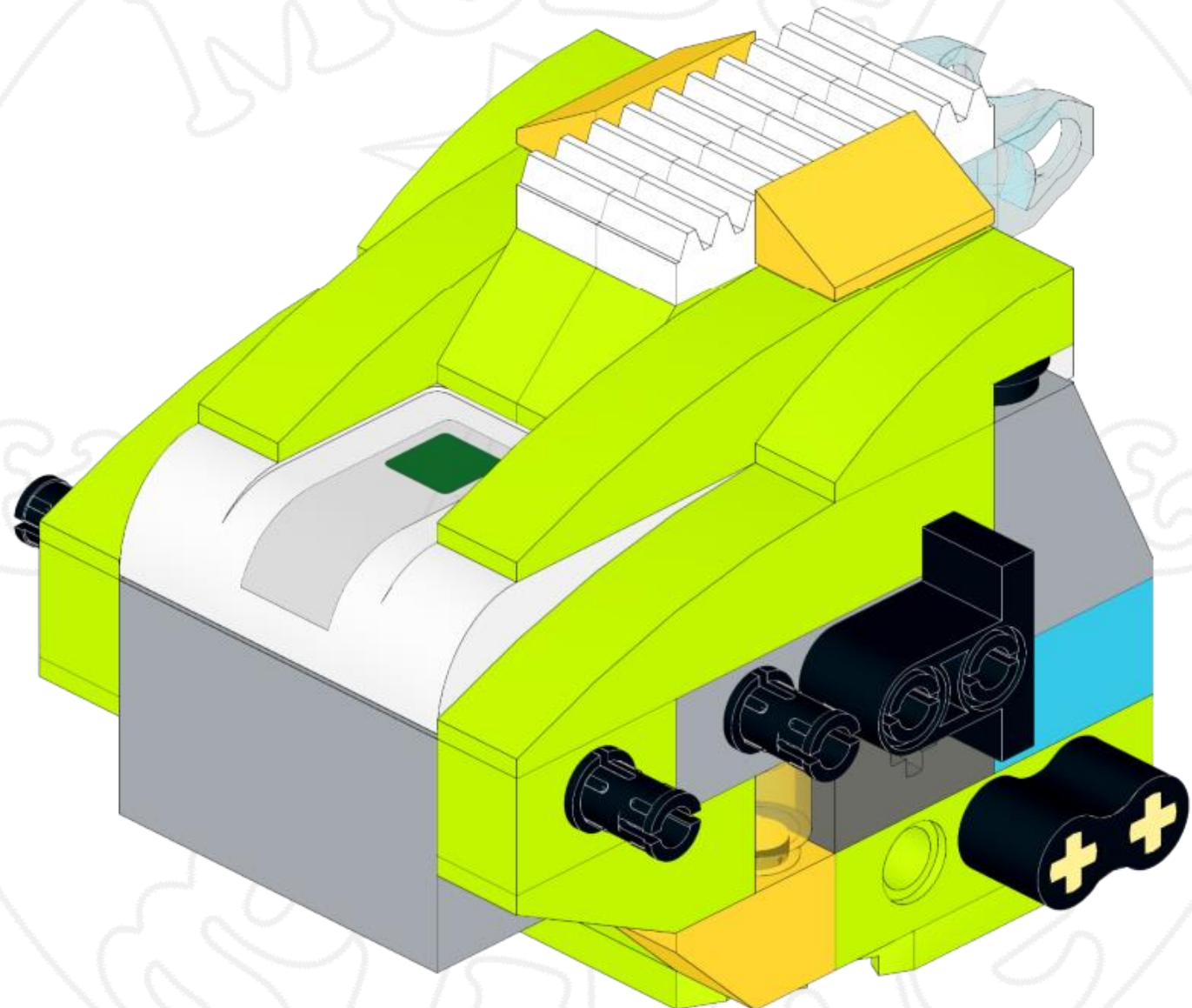

18

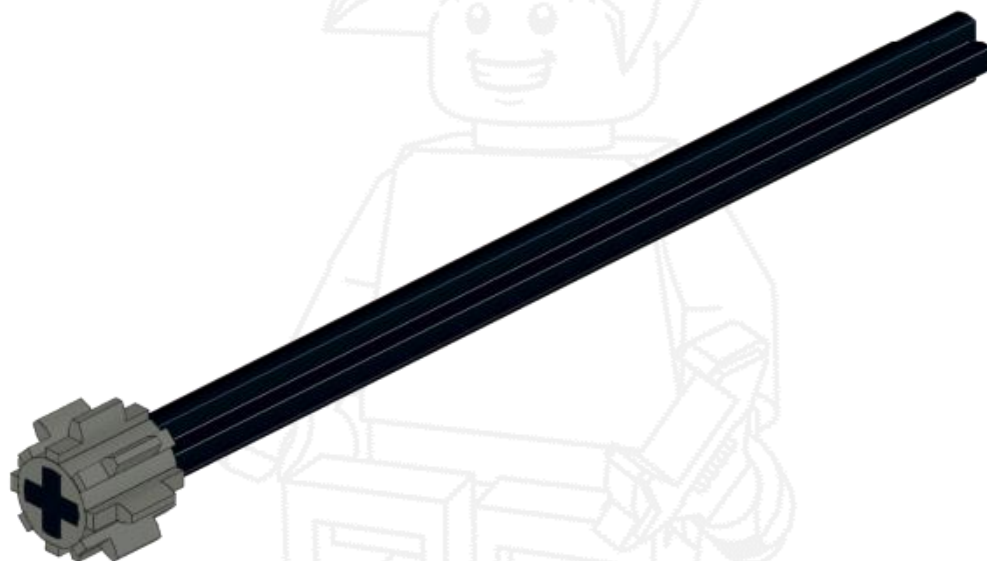
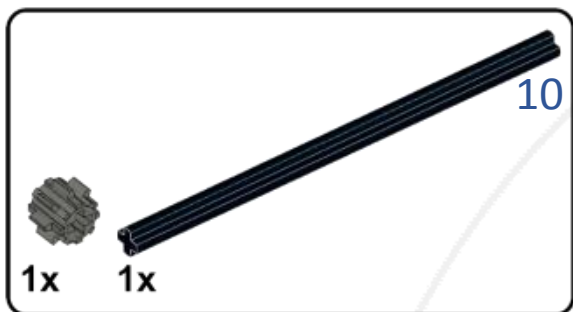

19

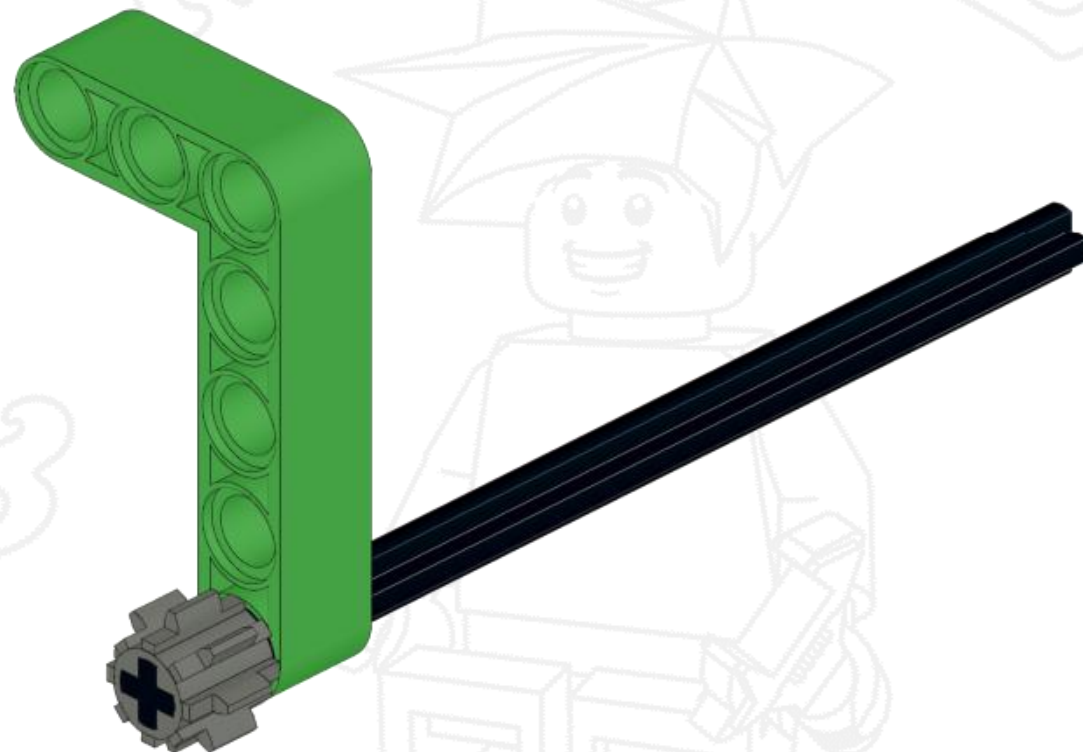
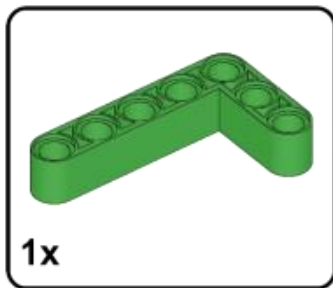

20

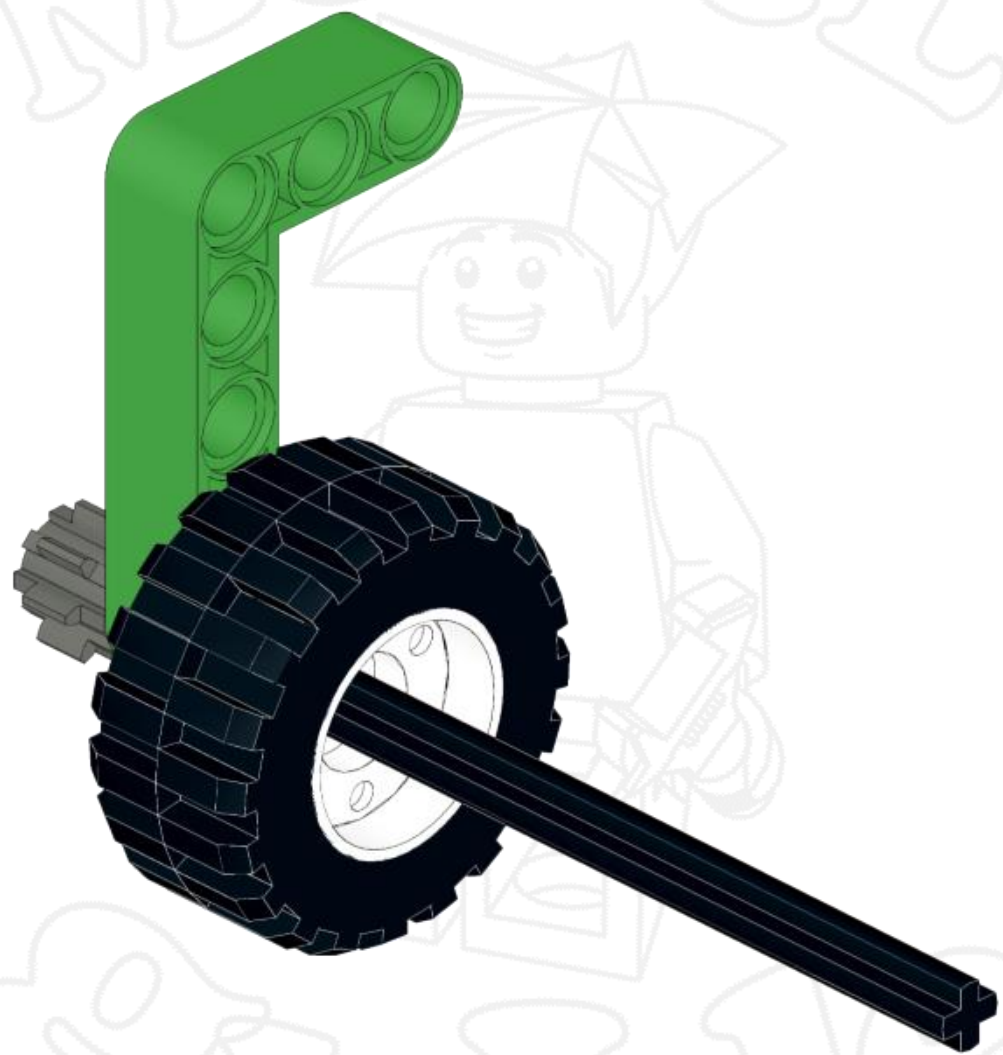
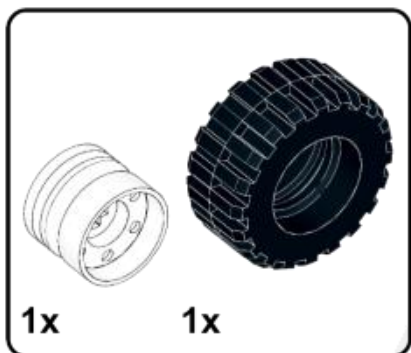

21

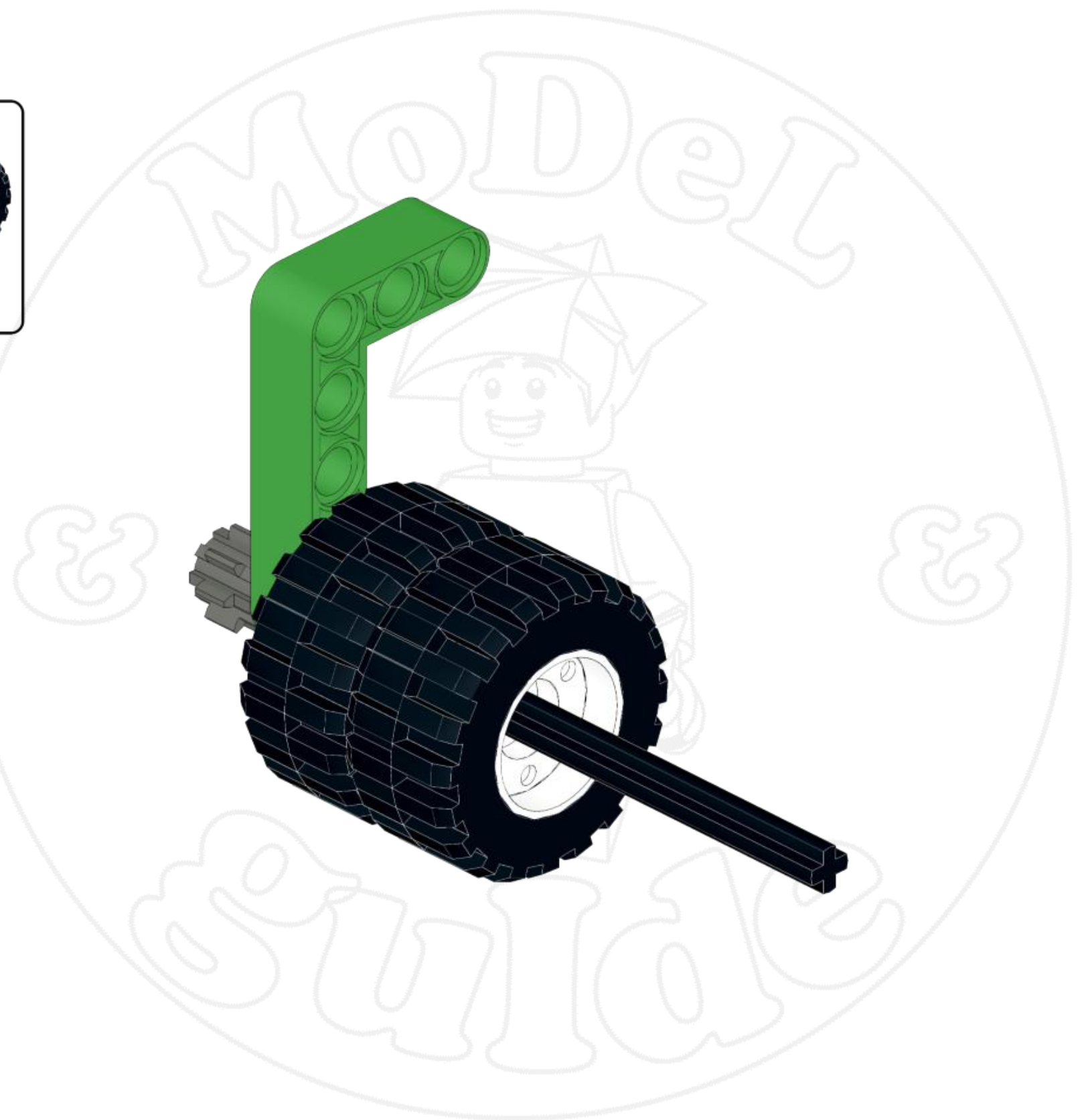
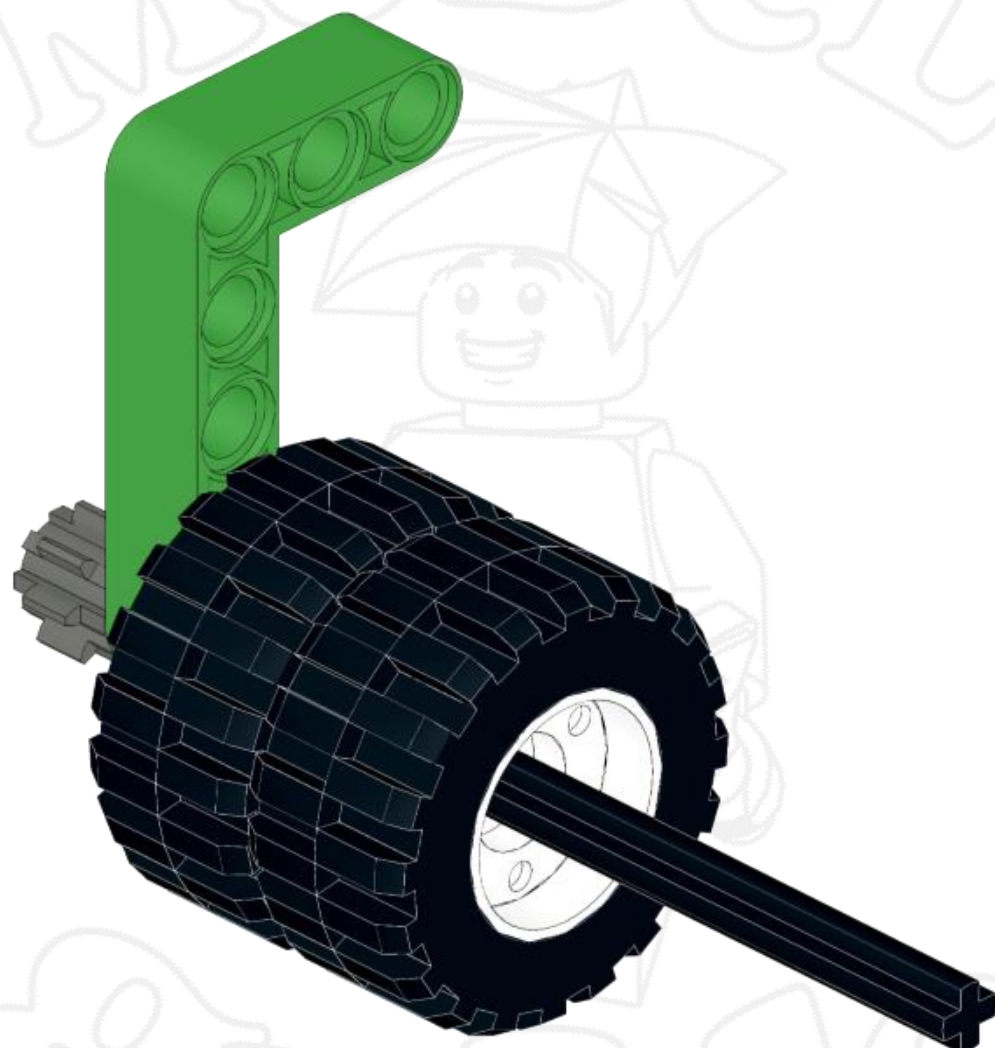
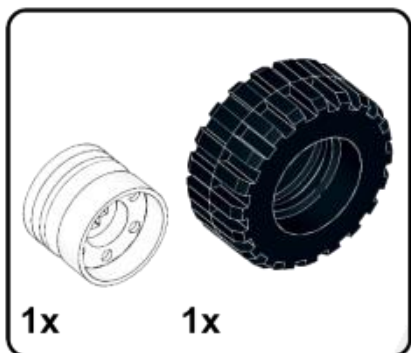

22

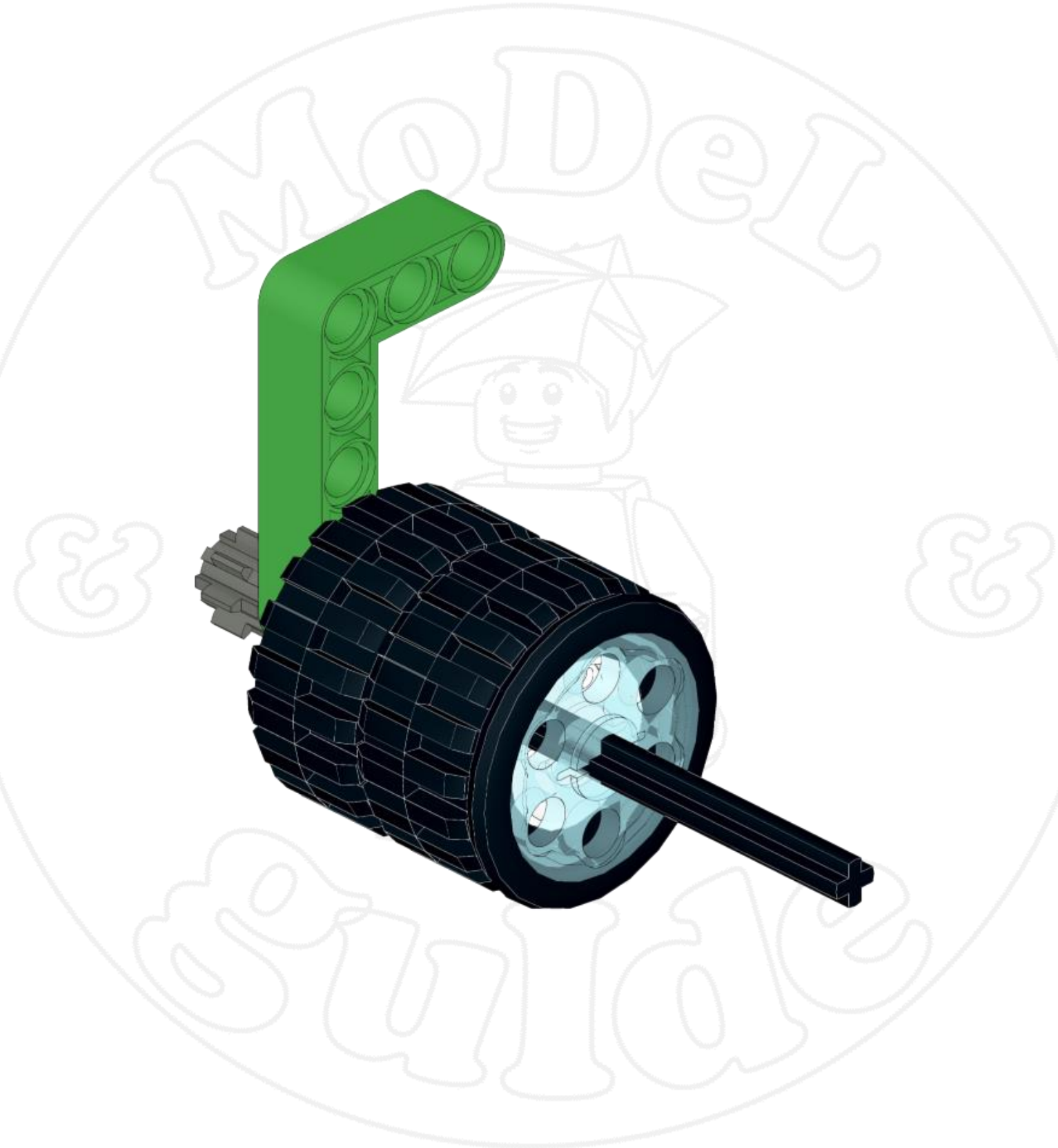
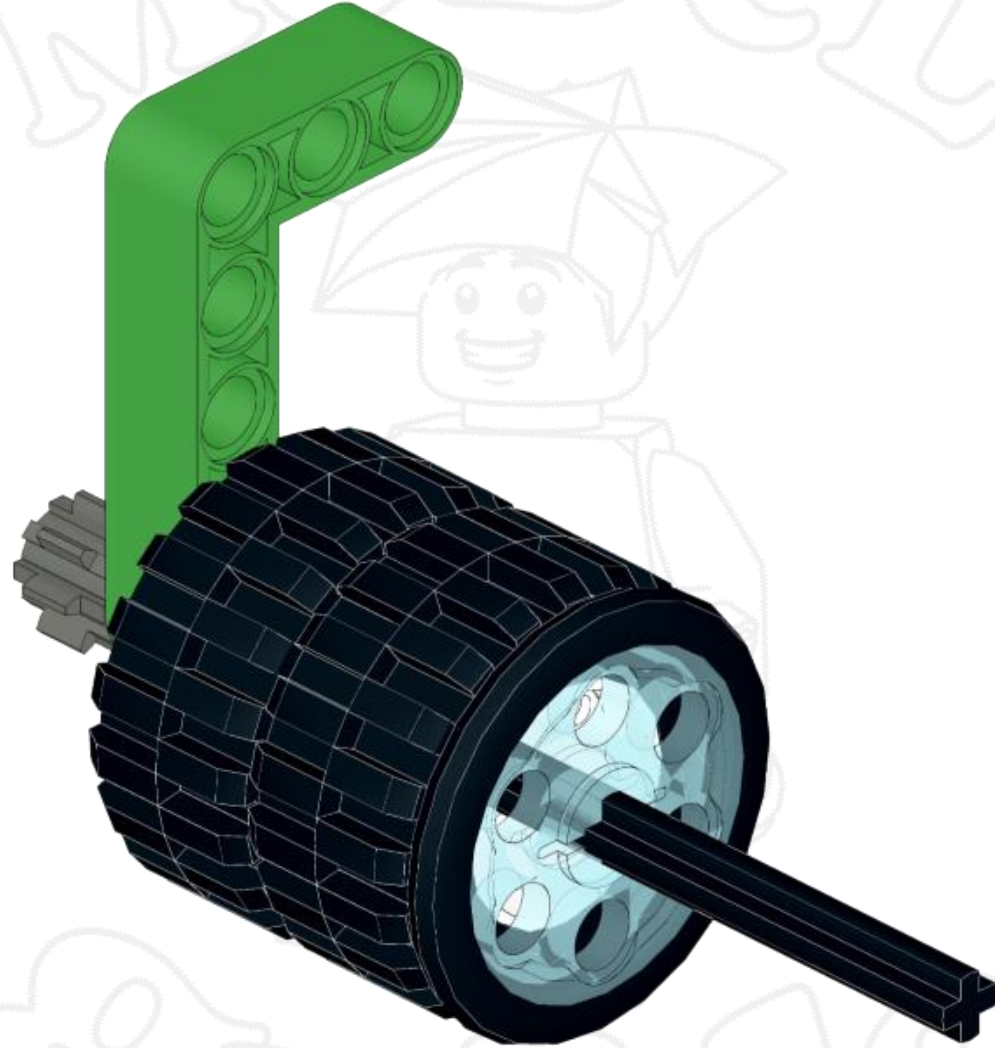

23

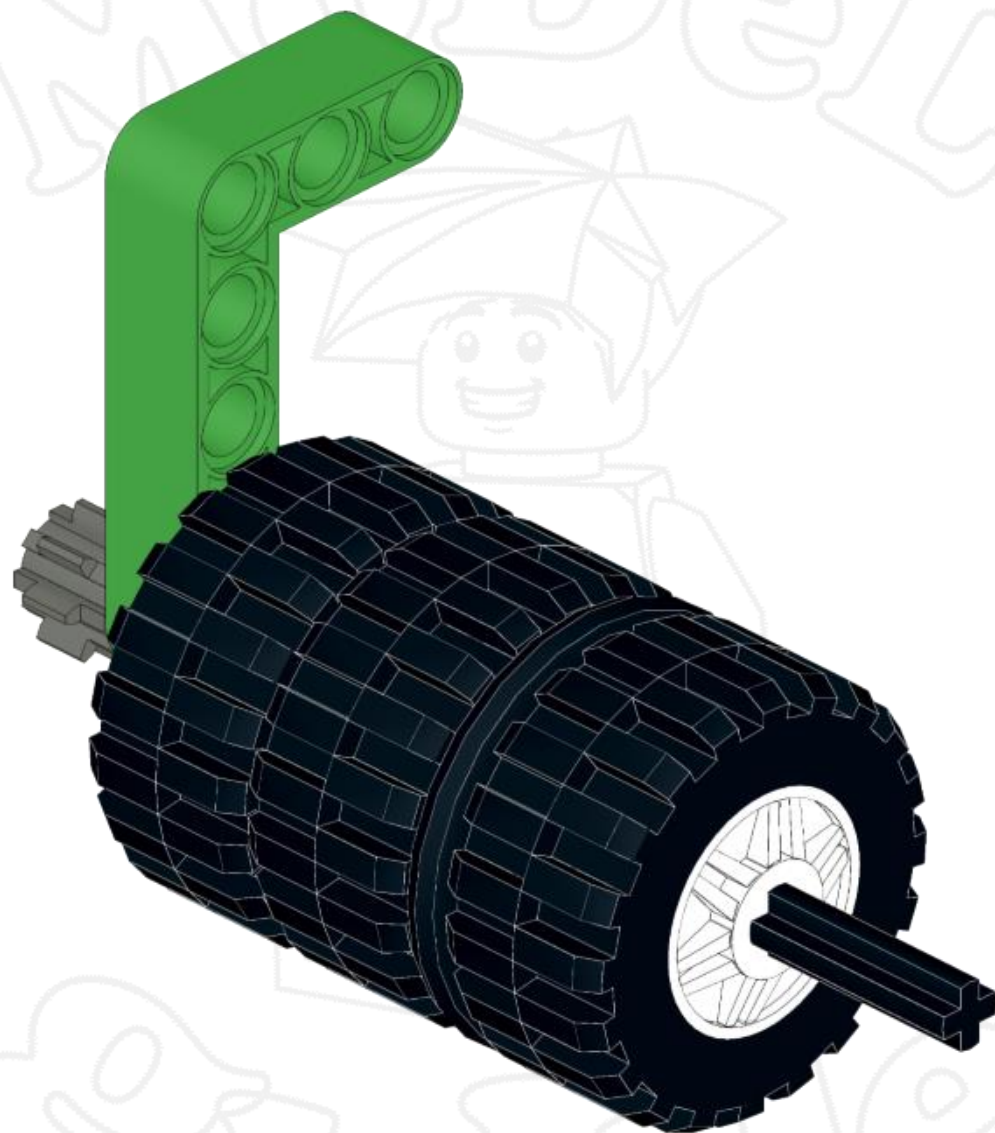
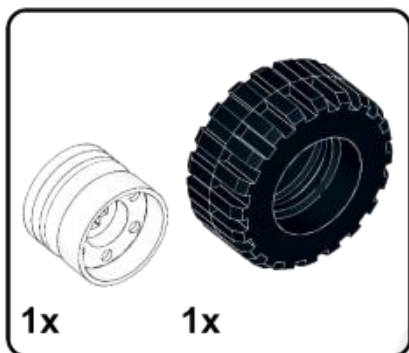

24

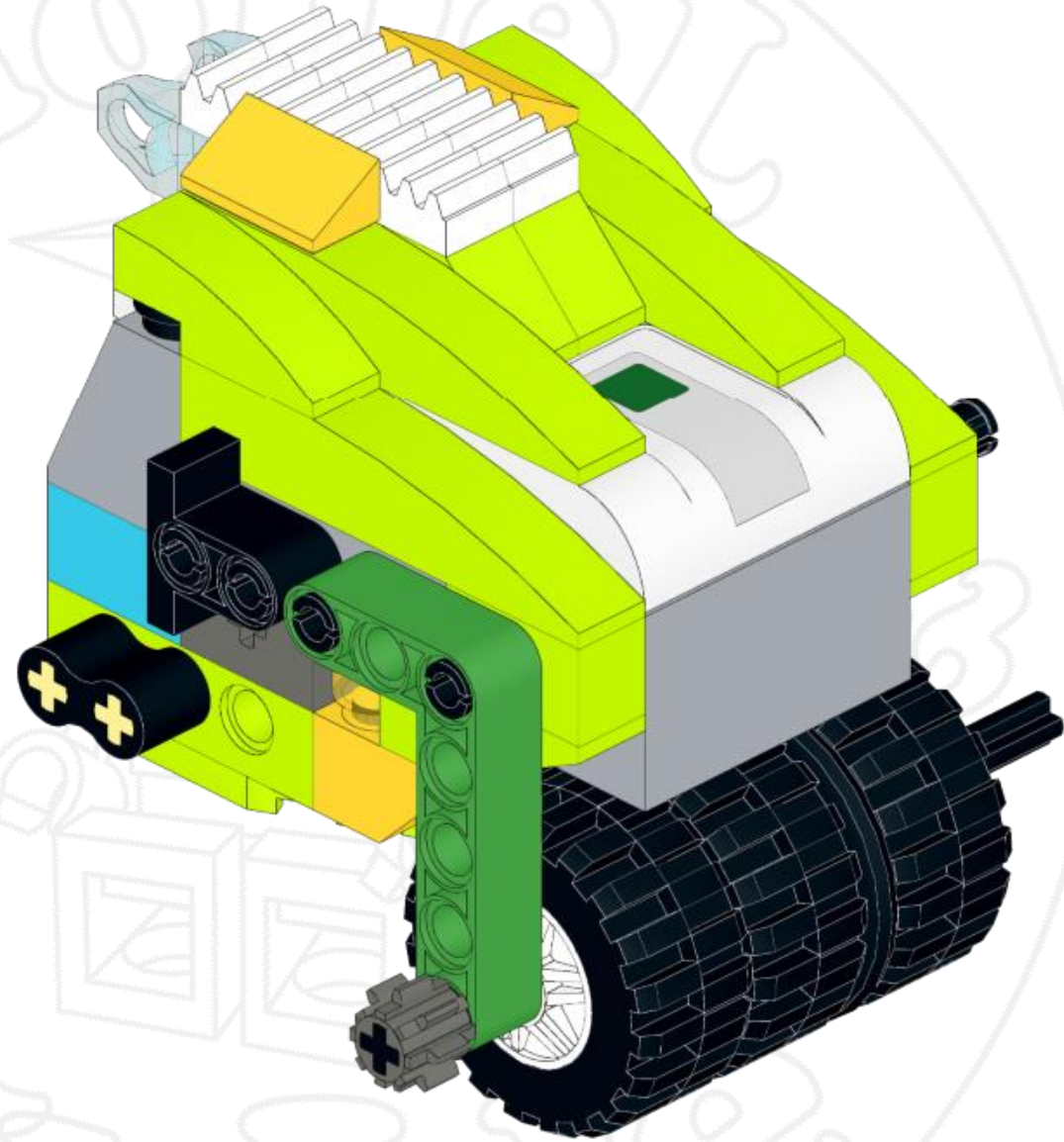
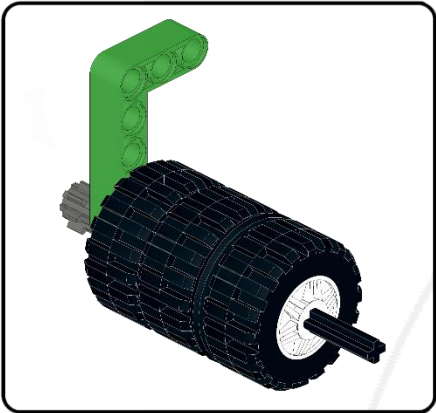

25

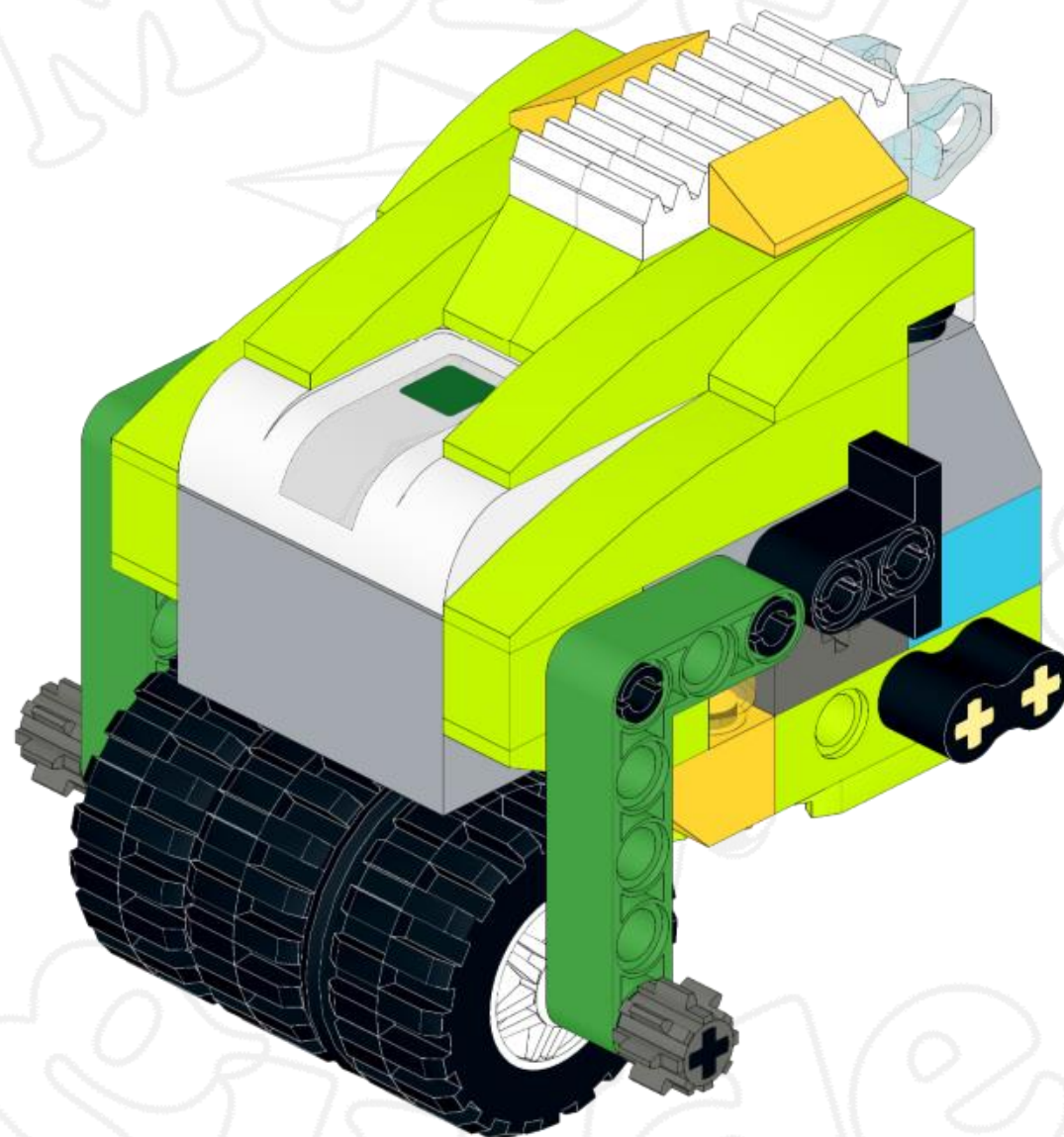
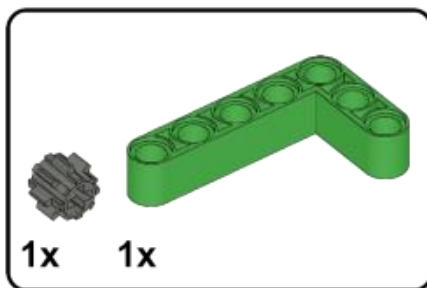

26

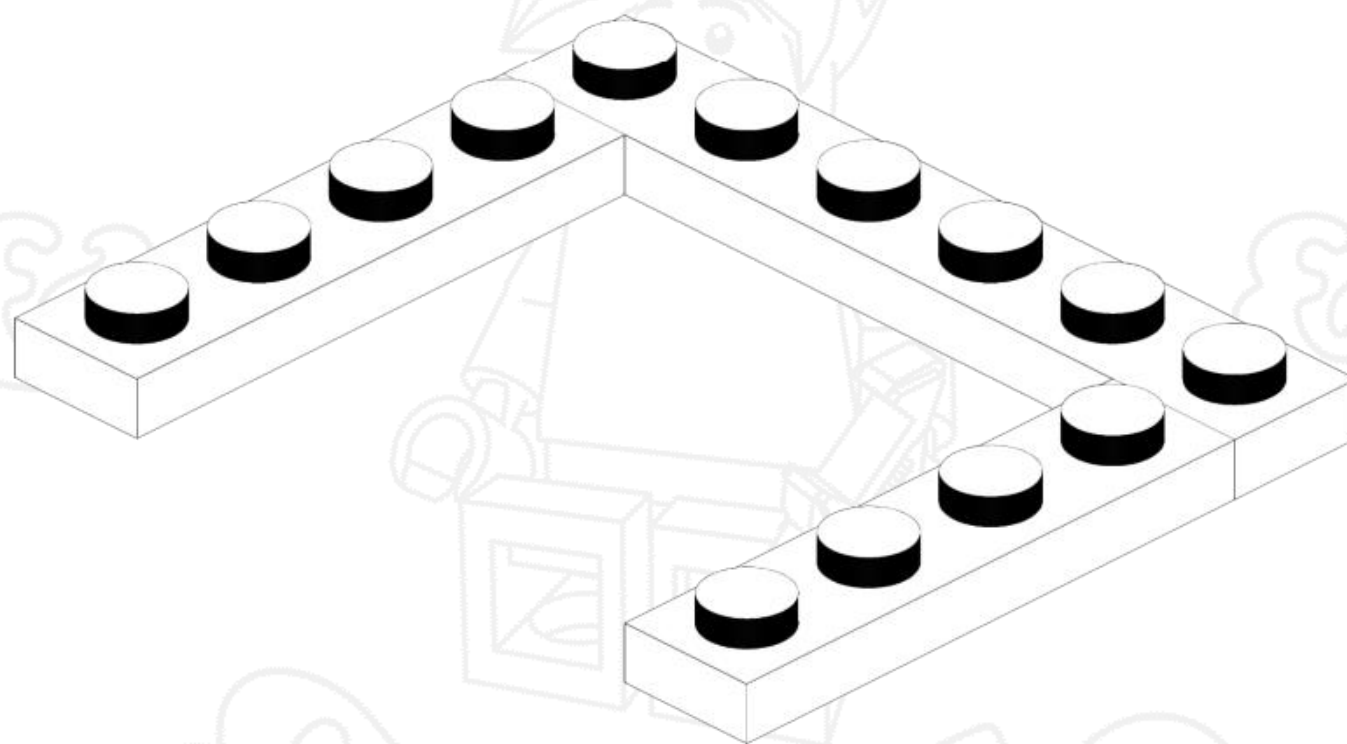
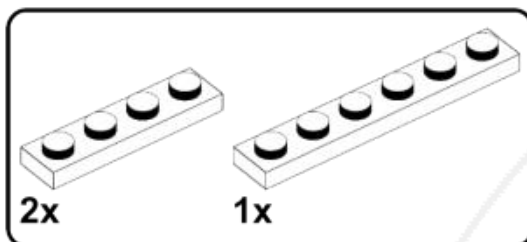

Model
Guide

27

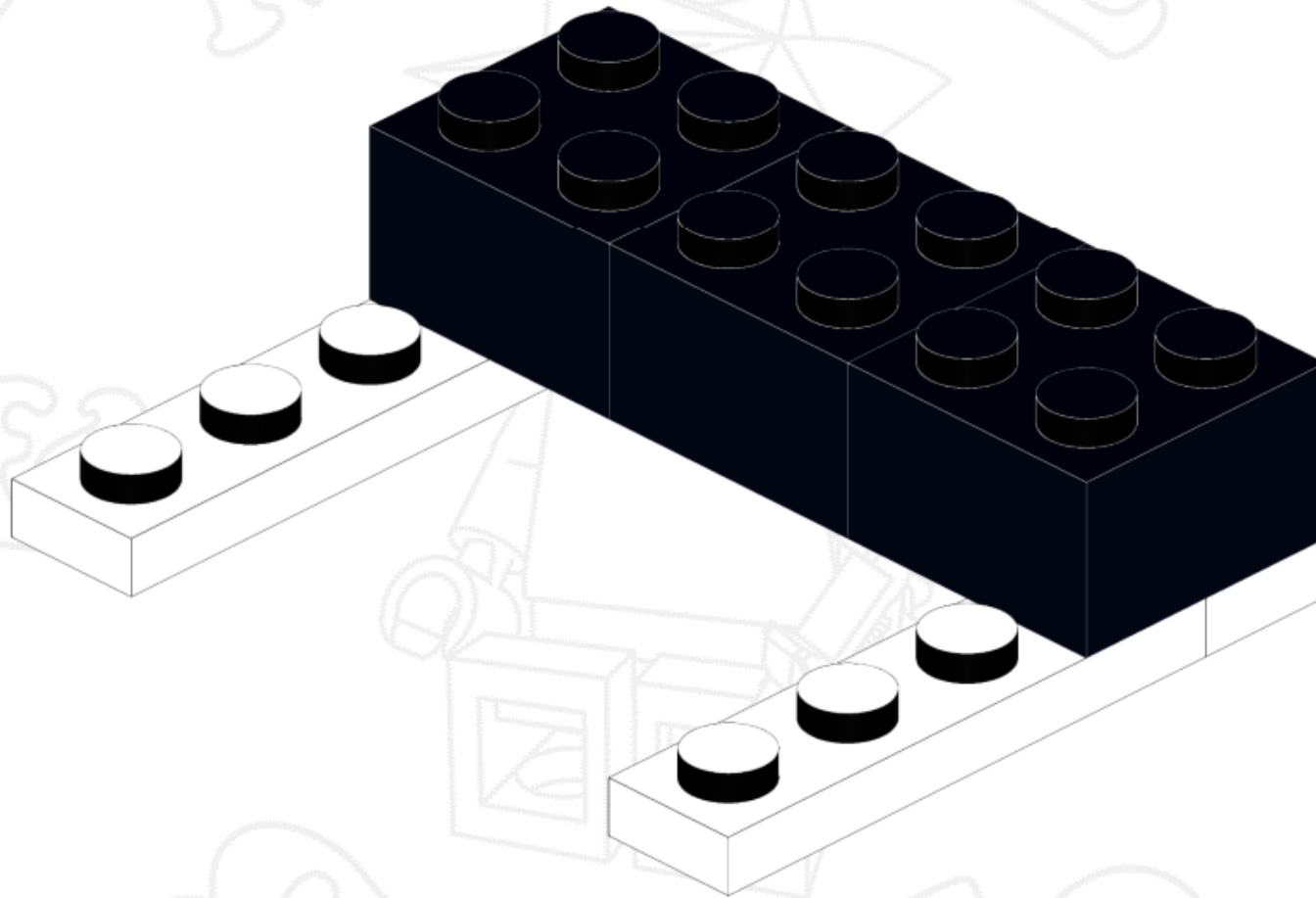
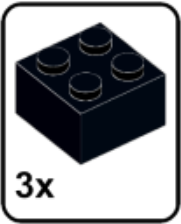

28

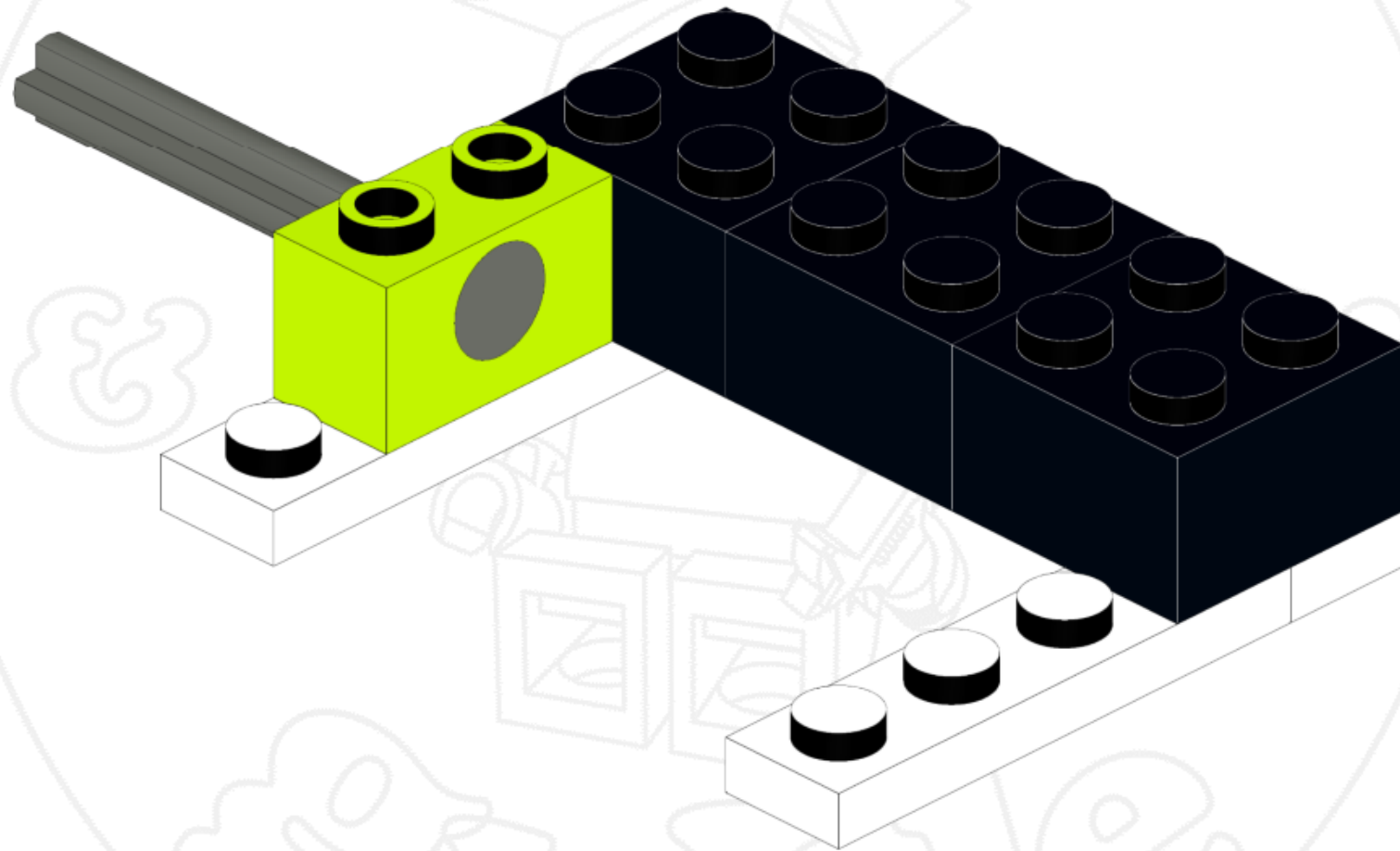
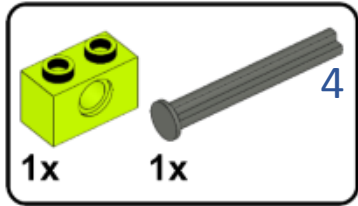

29

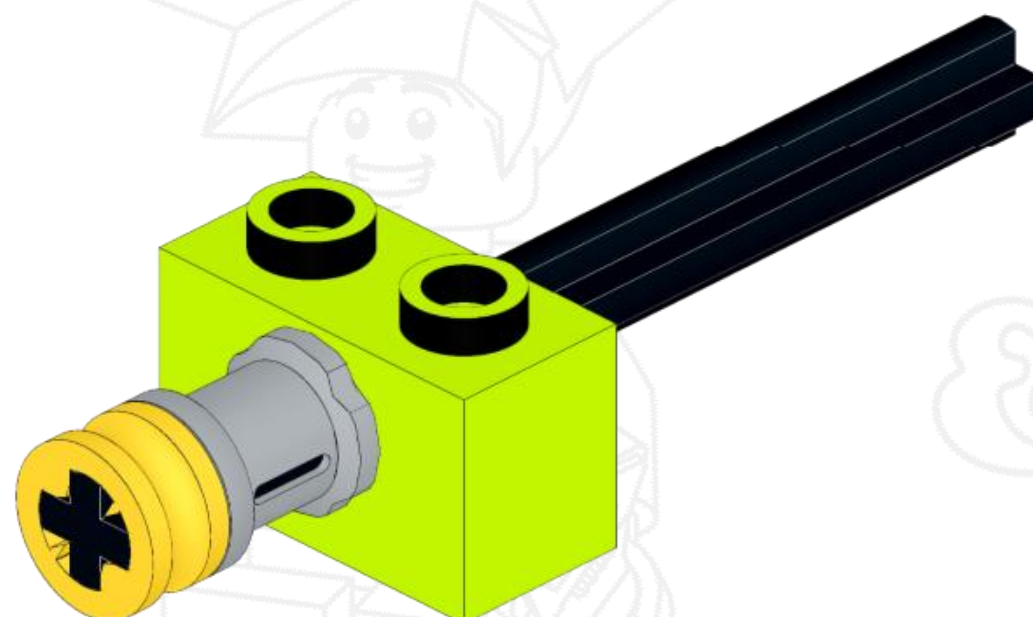
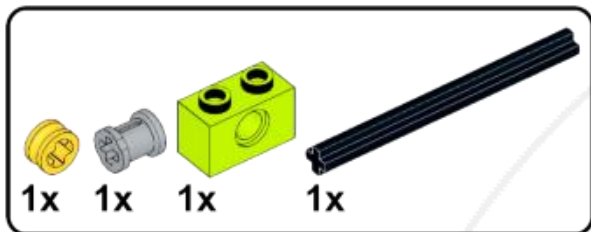

&

&

Build Guide

30

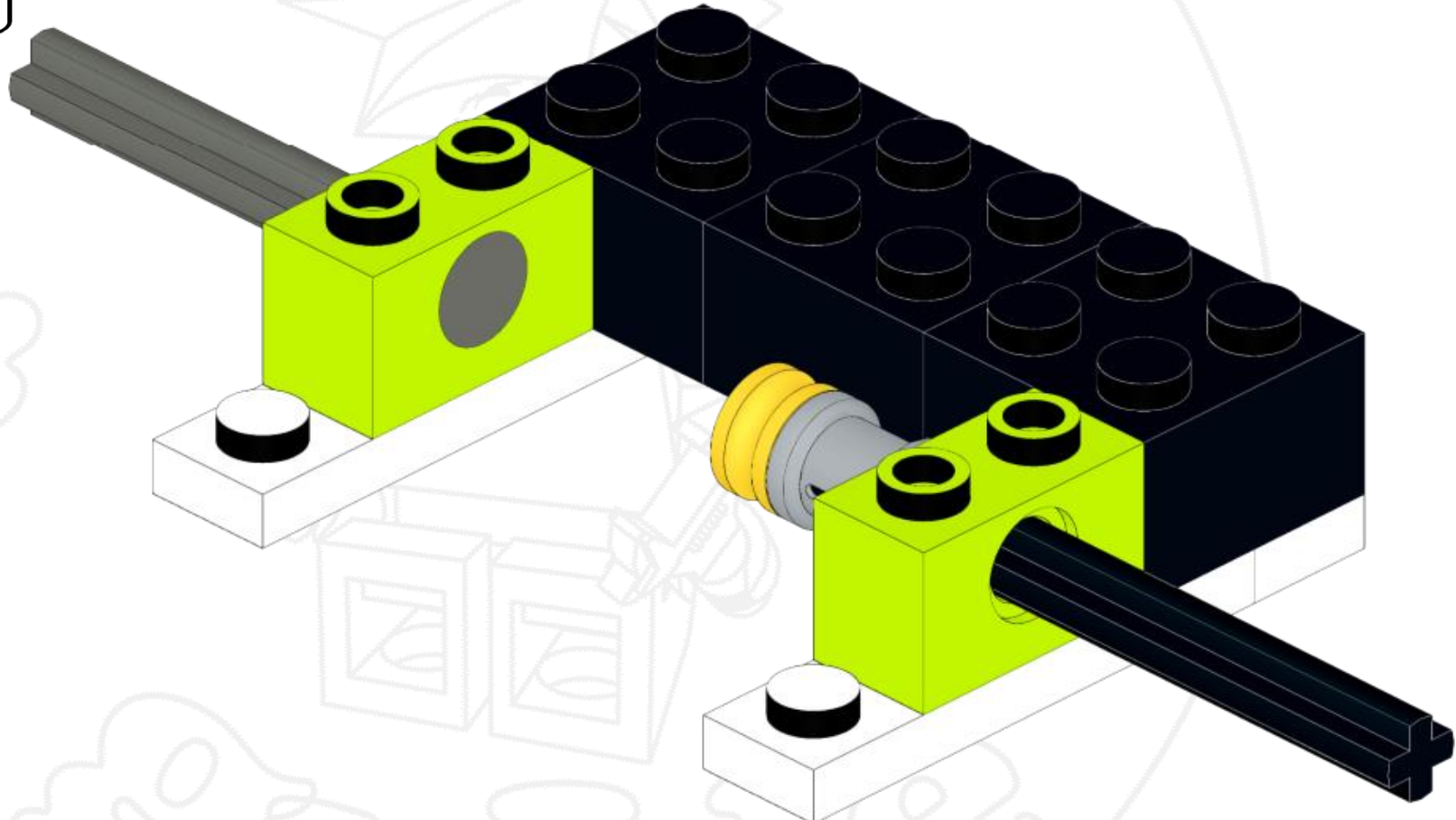
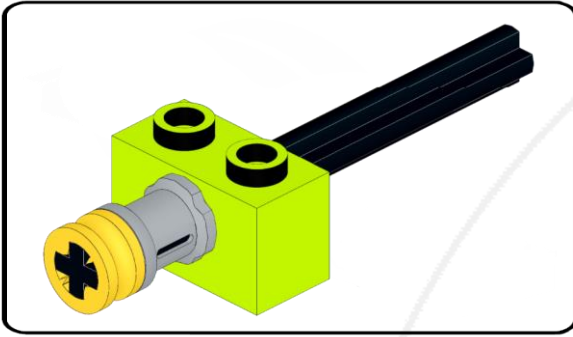

31

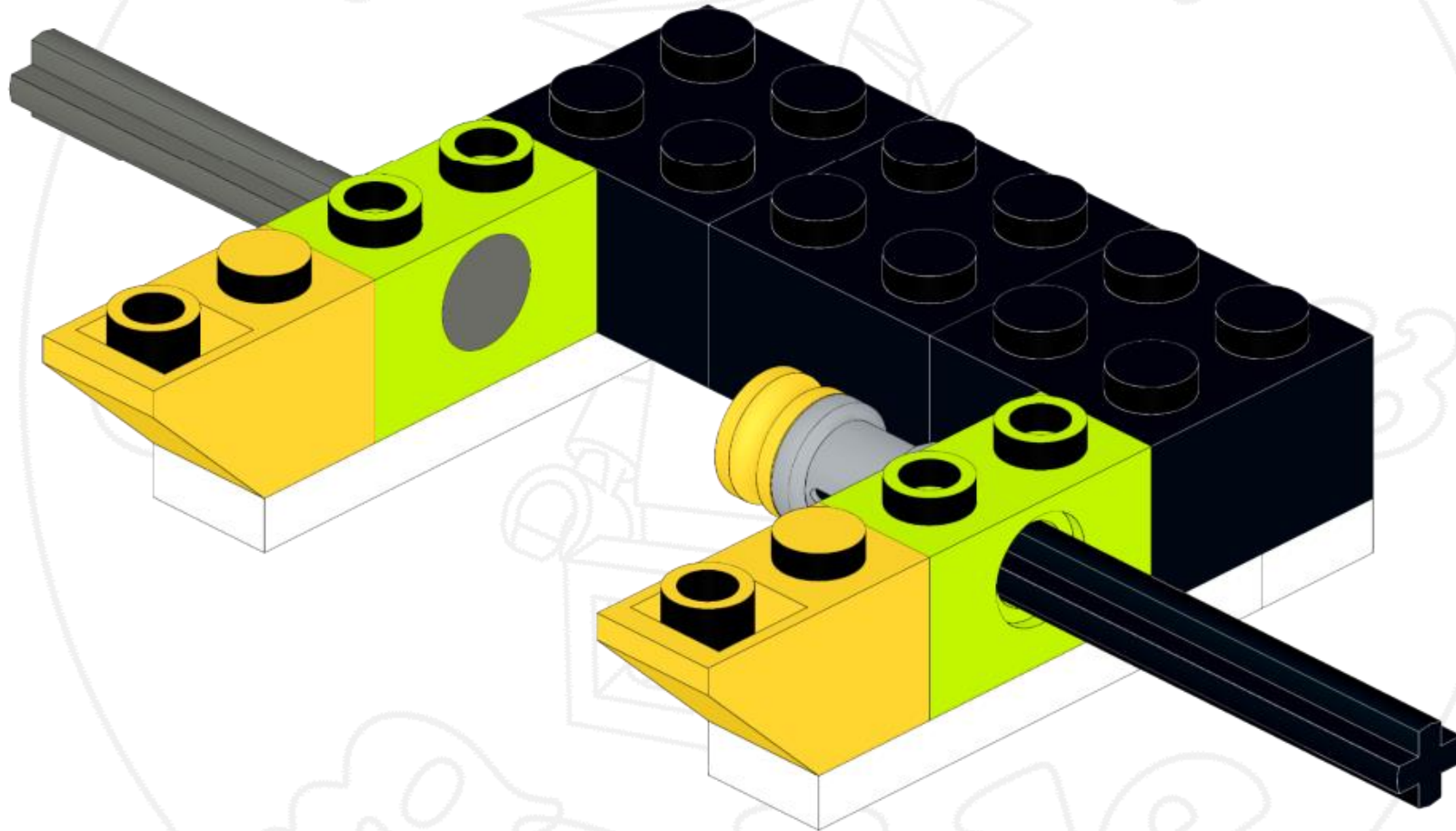
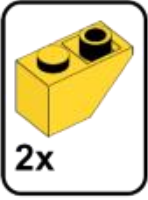

32

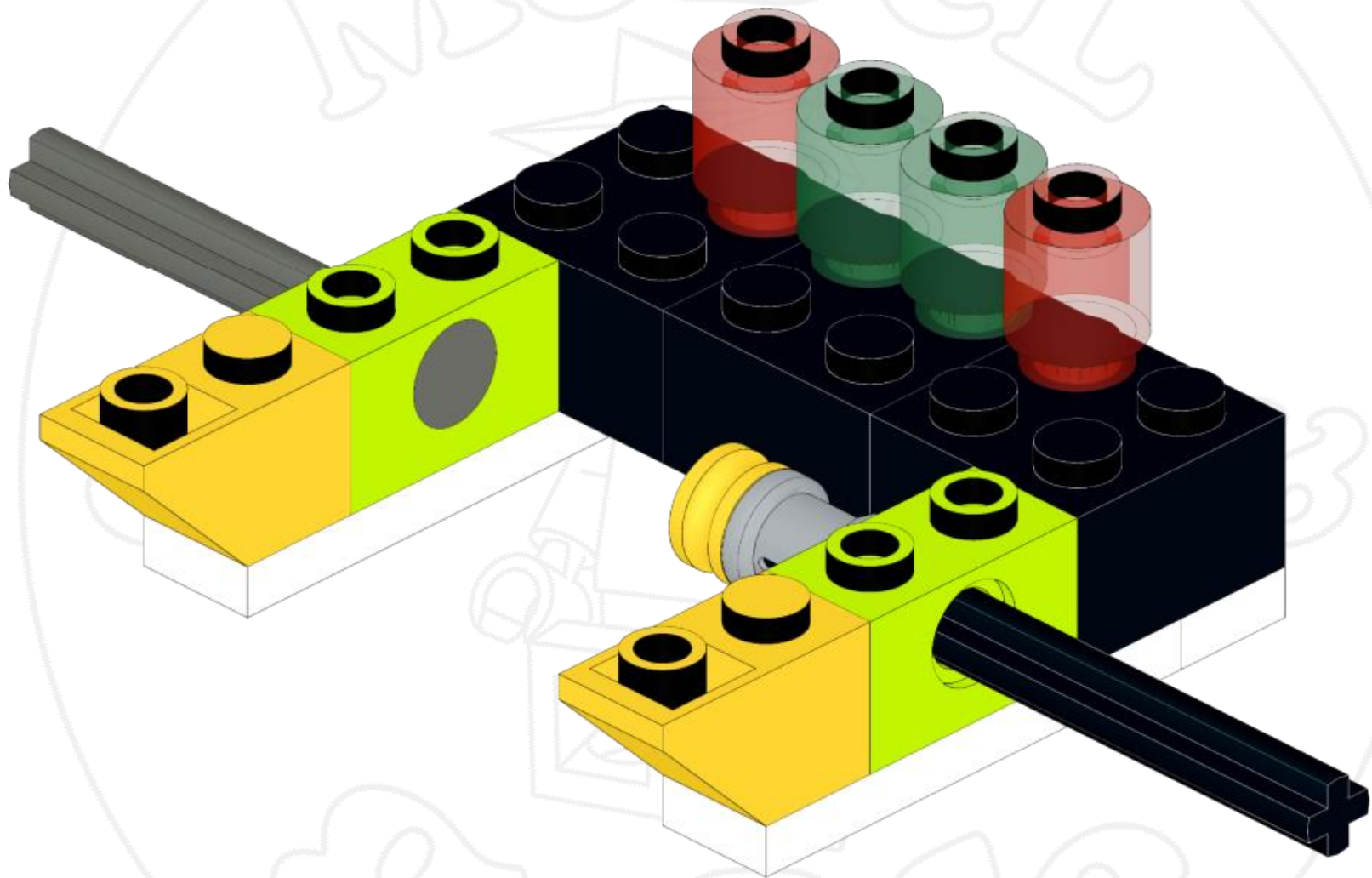
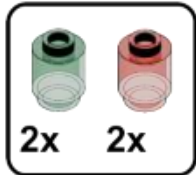

33

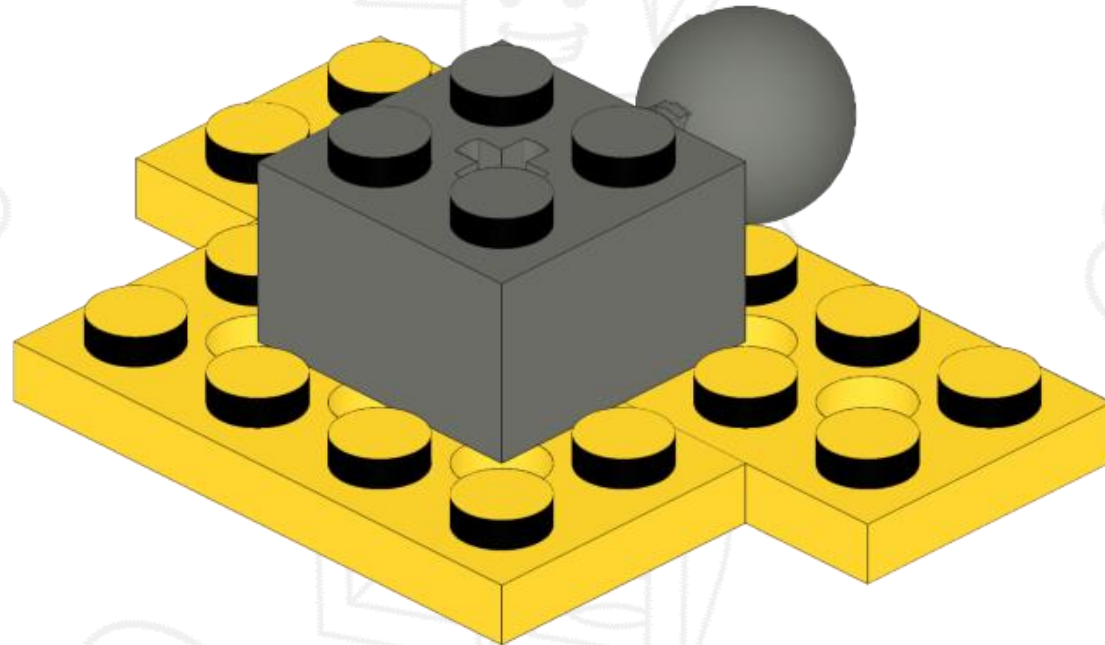
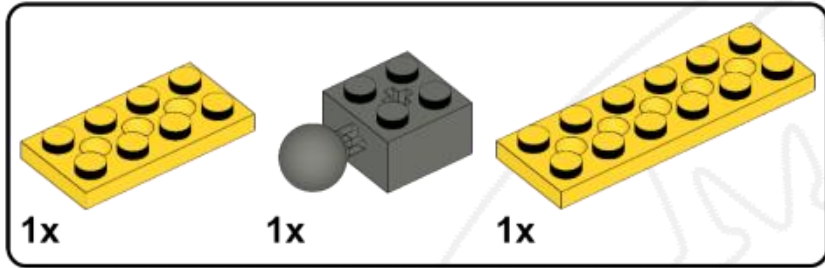

&

&

Build

34

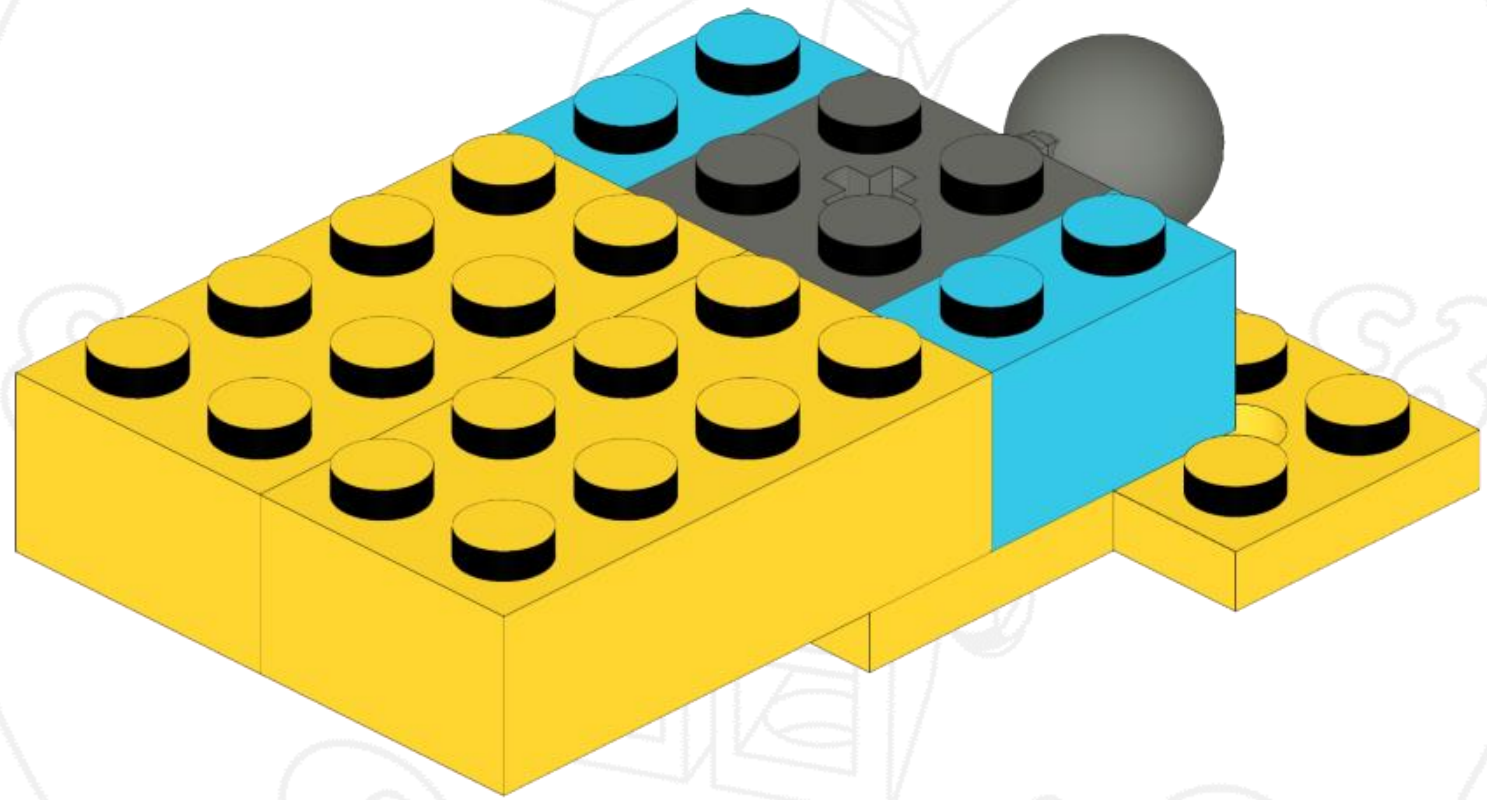
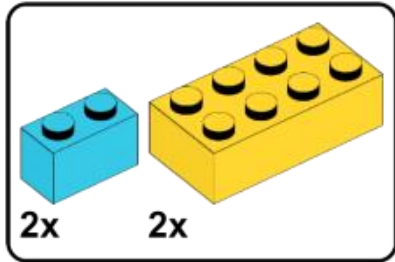

Model

Guide

35

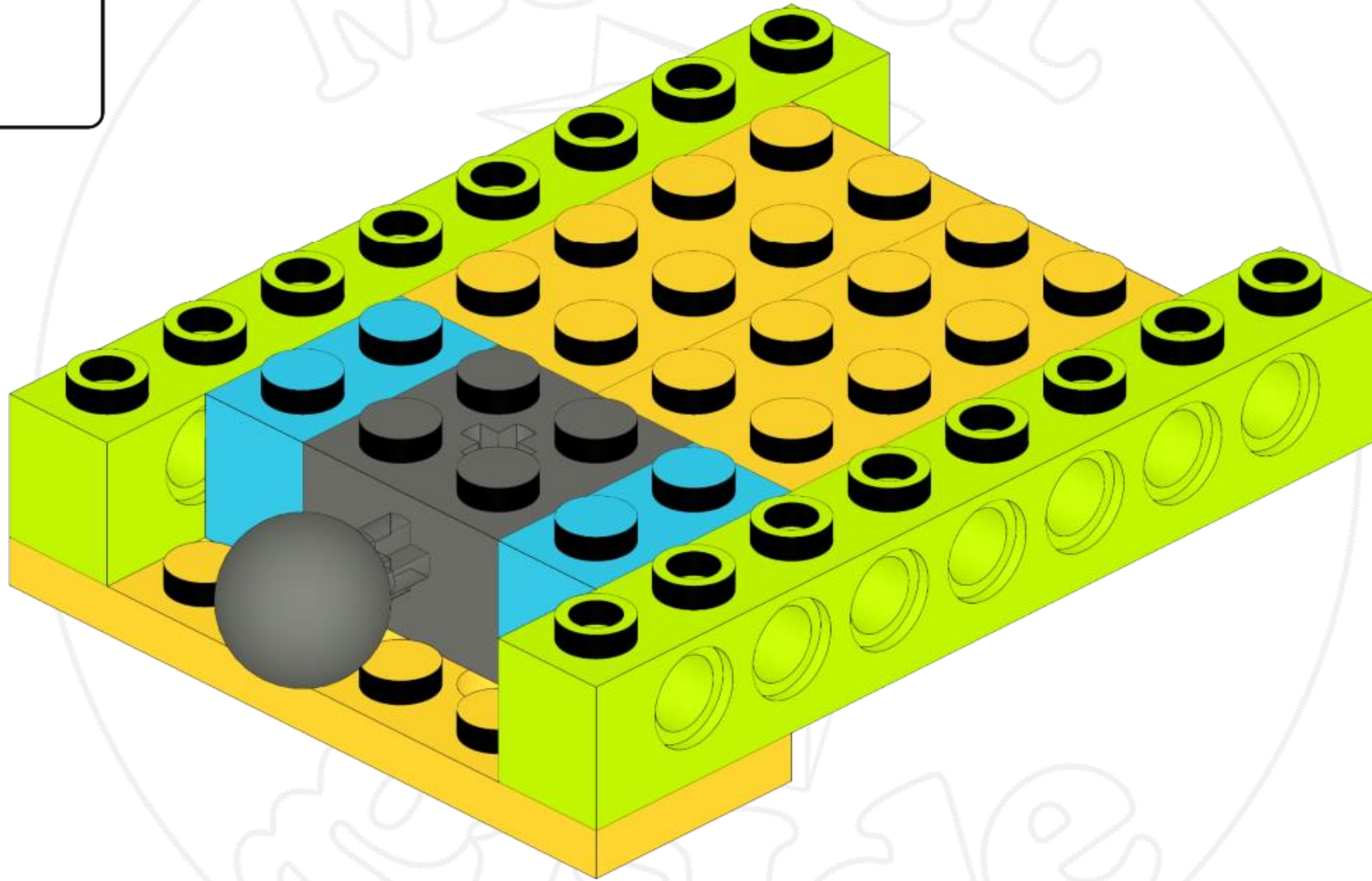
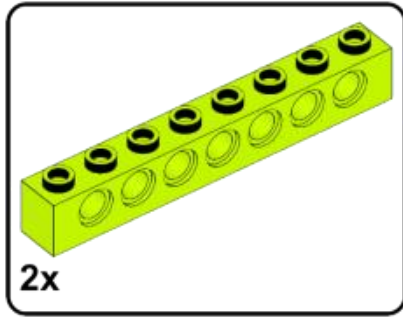

36

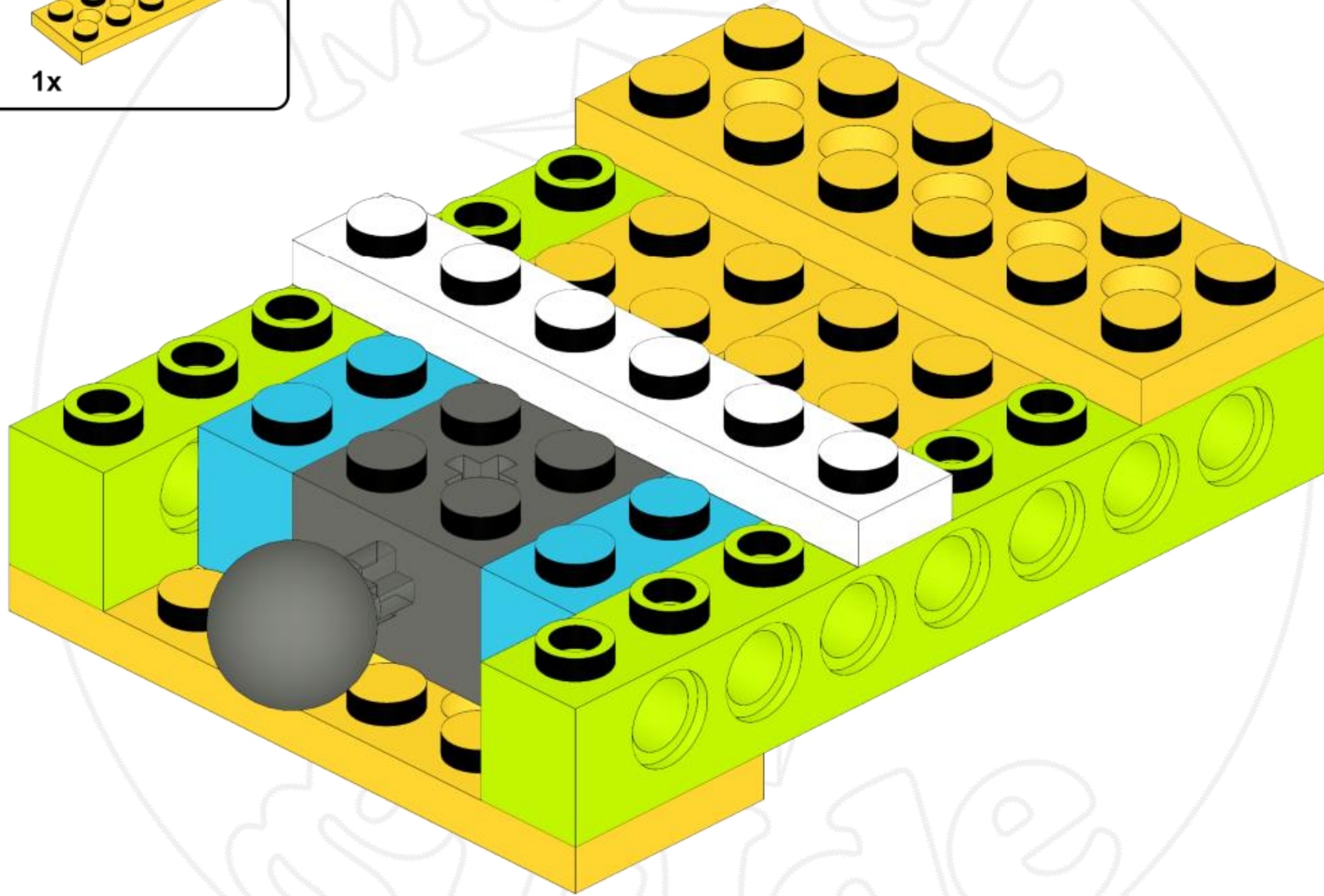
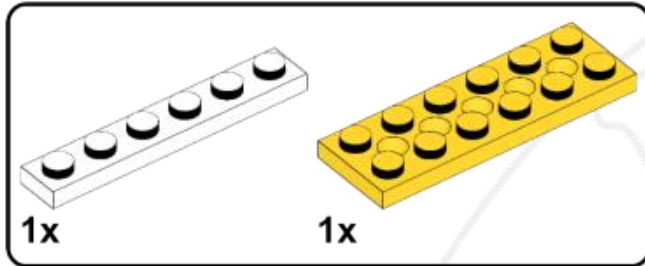

37

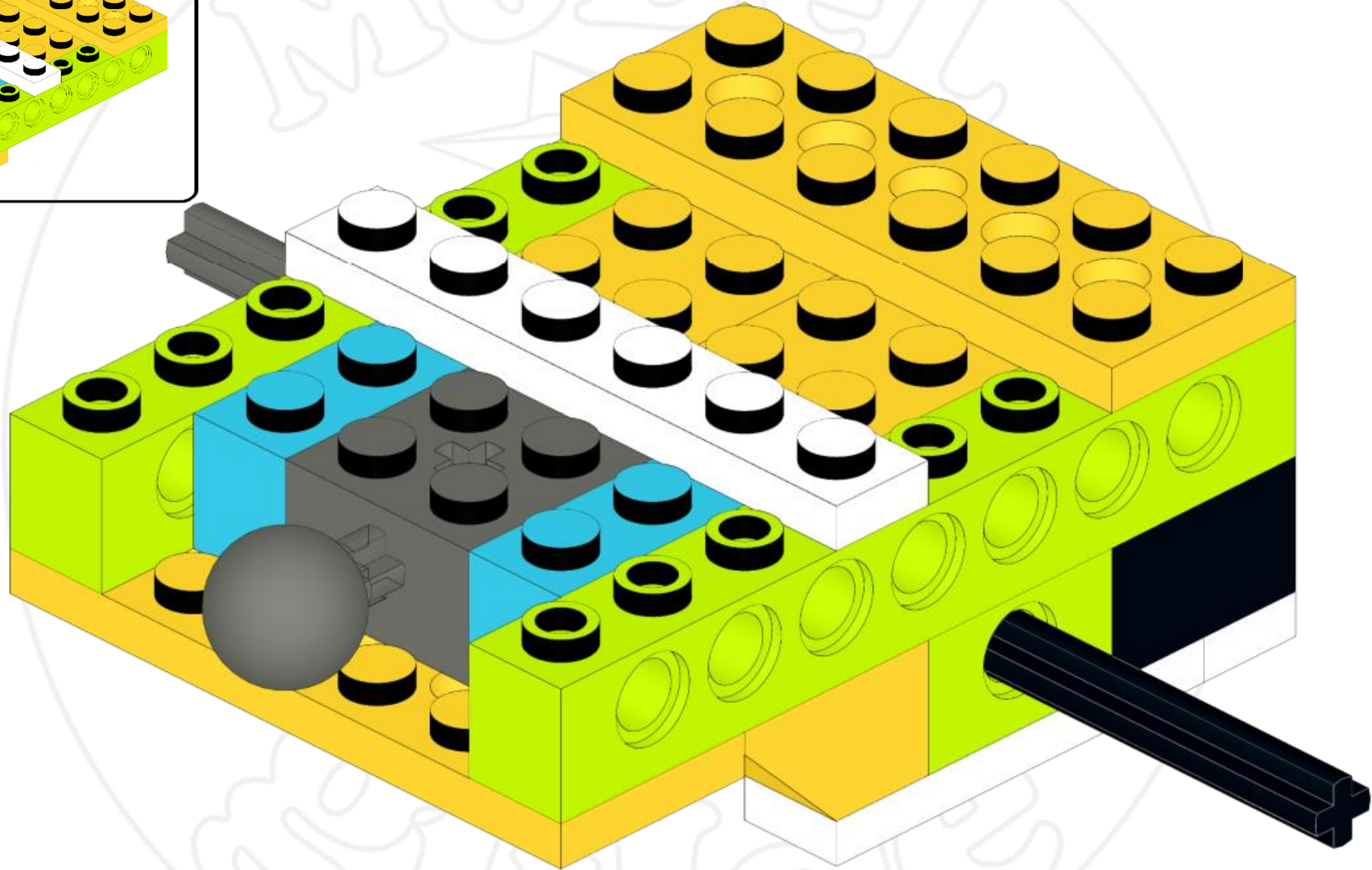
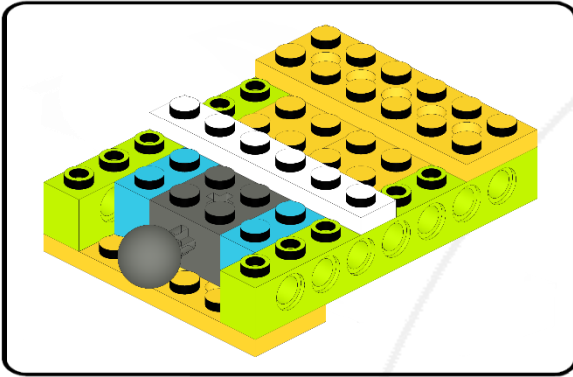

38

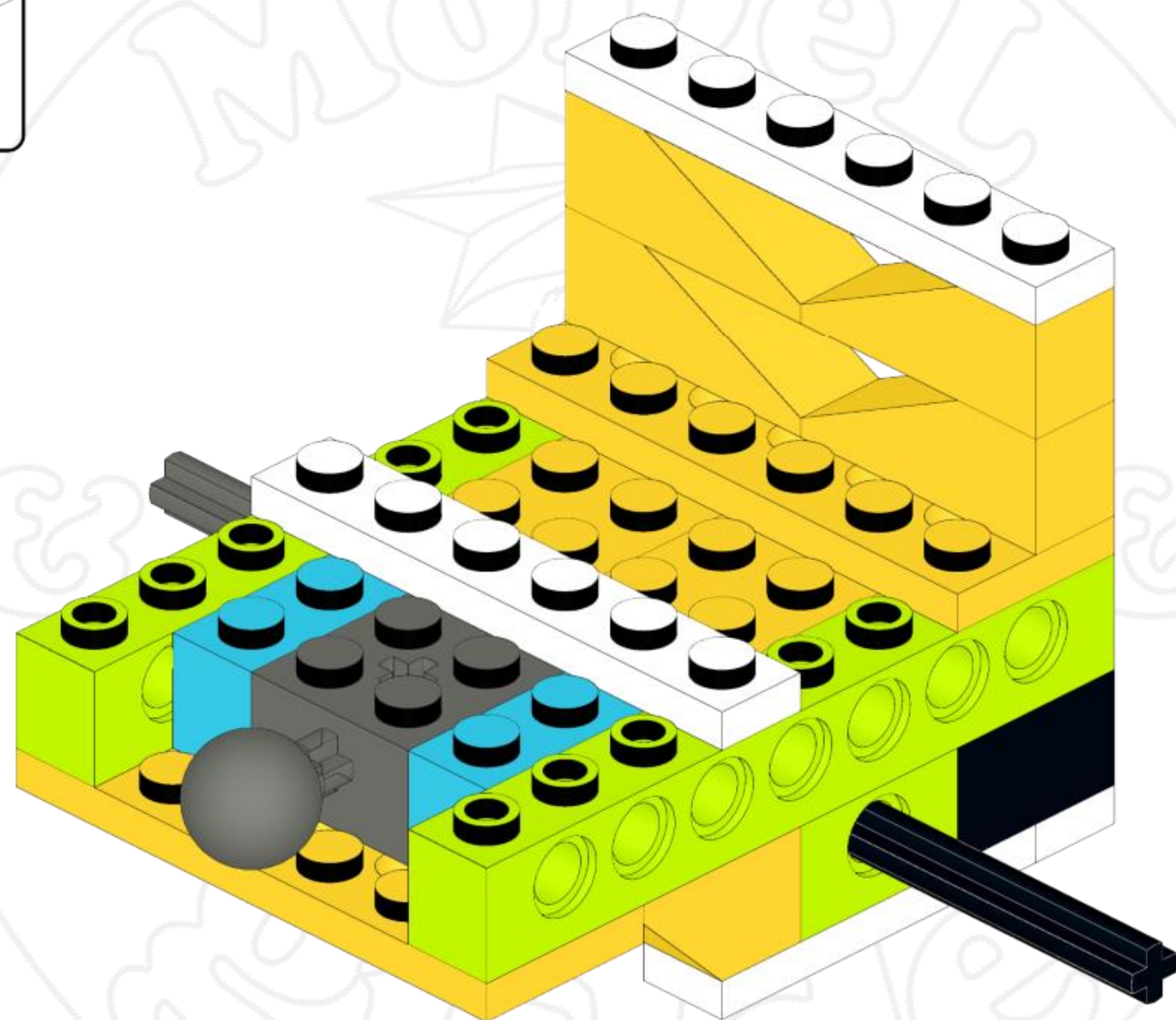
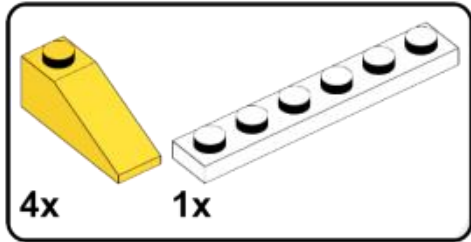

39

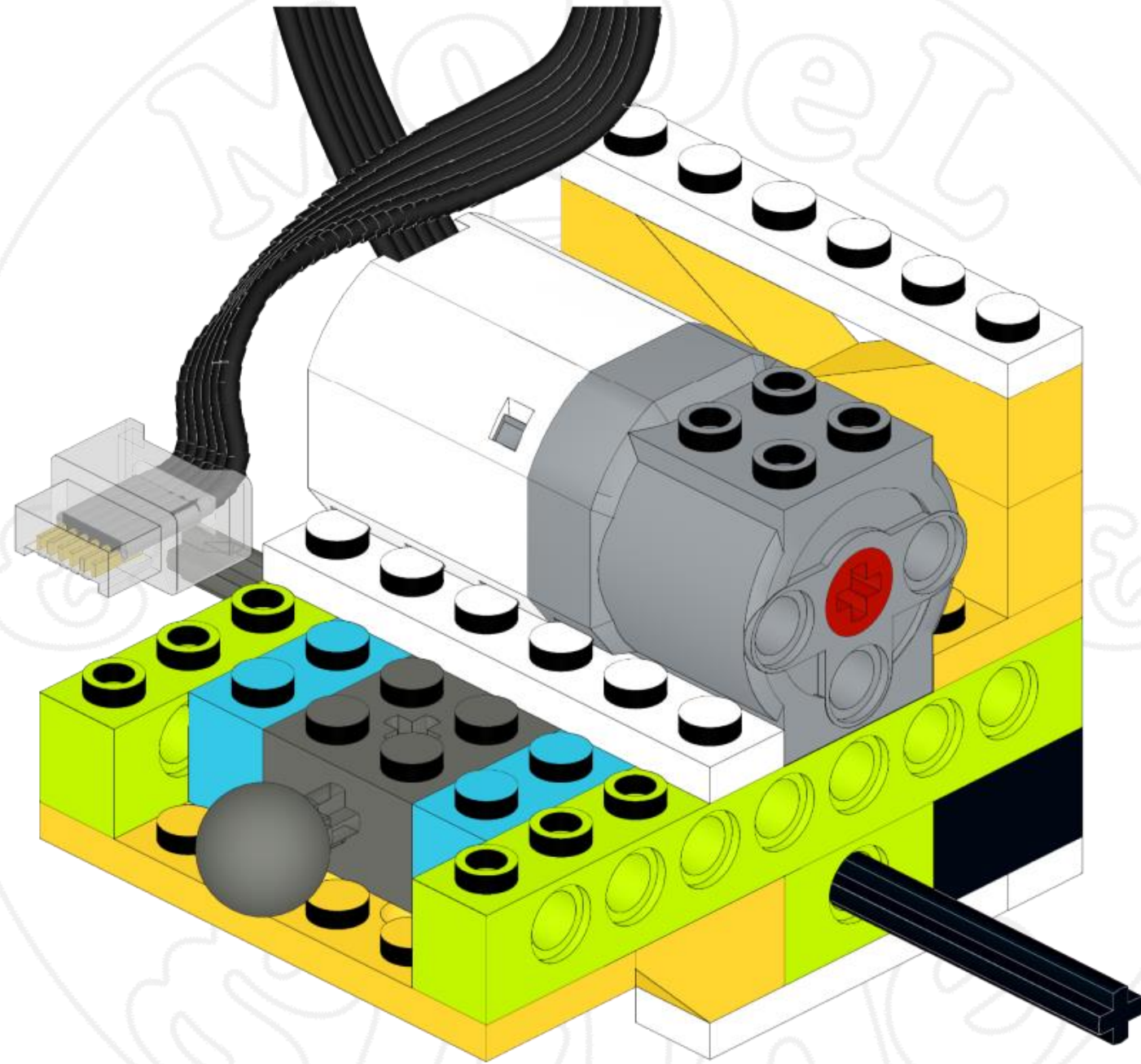

40

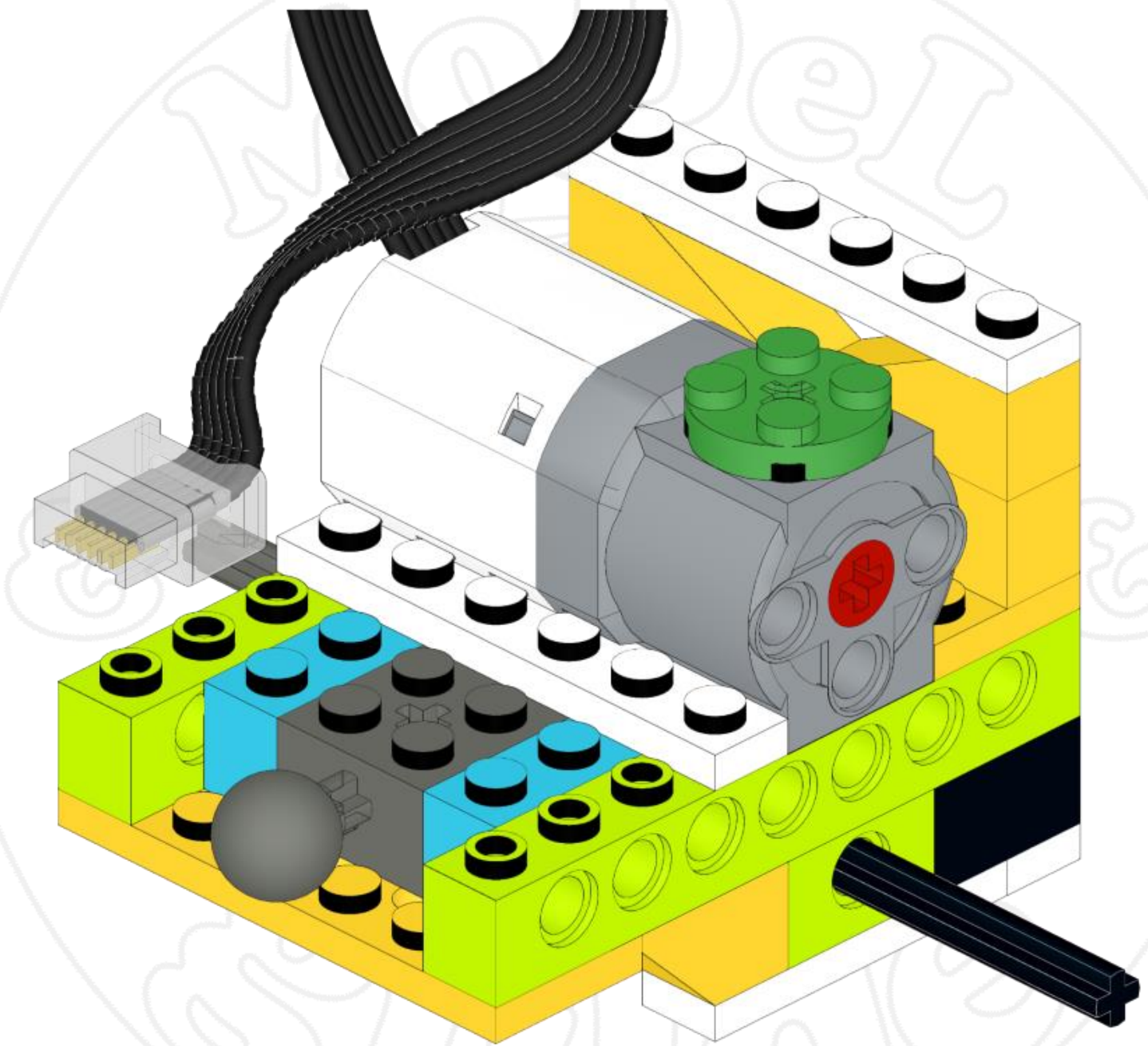
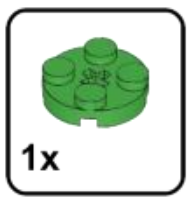

41

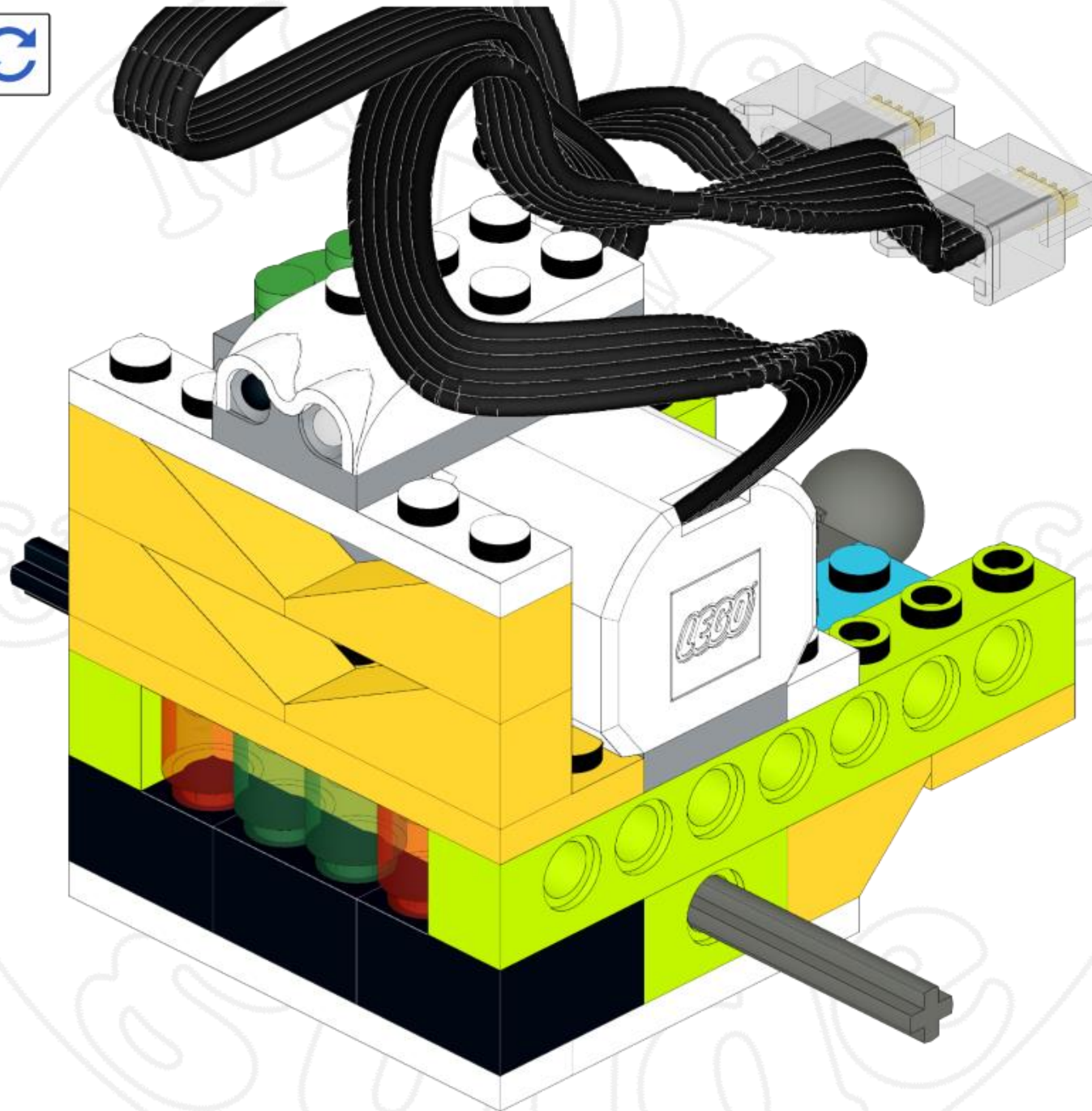
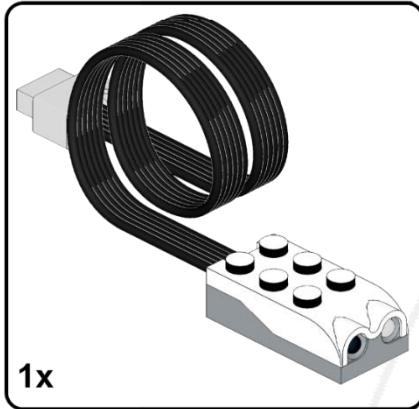

42

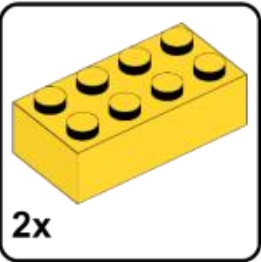

43

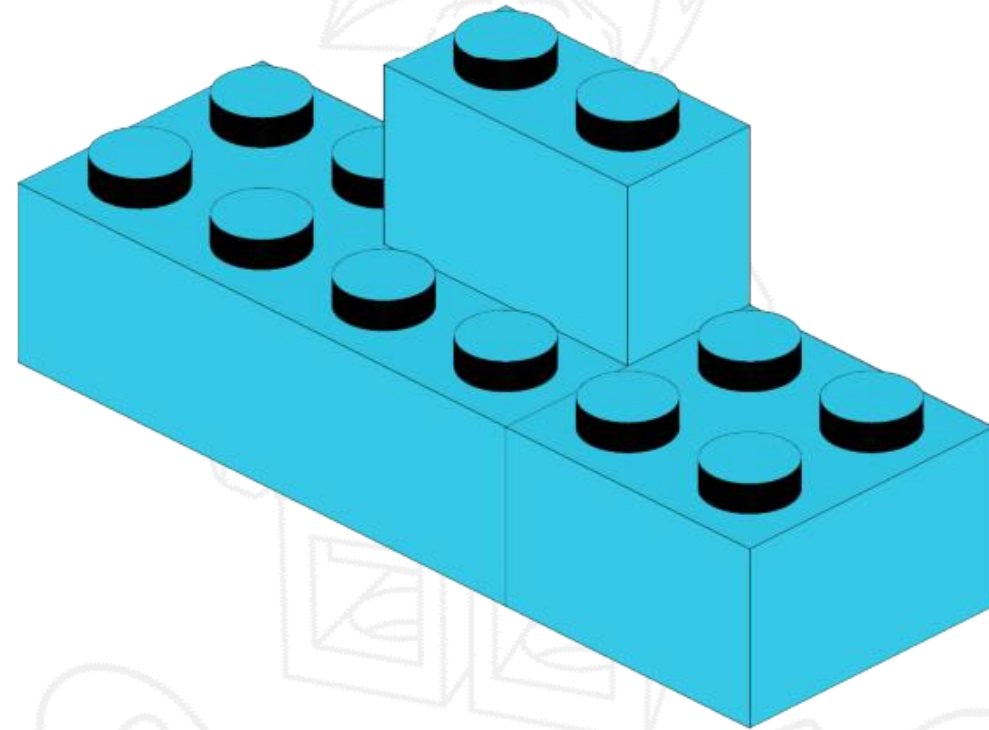
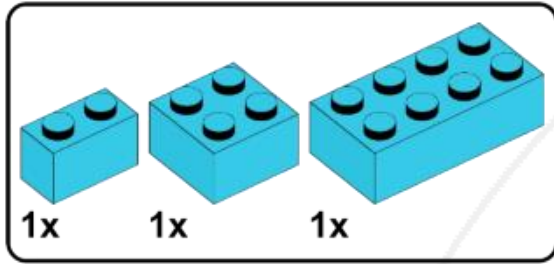

44

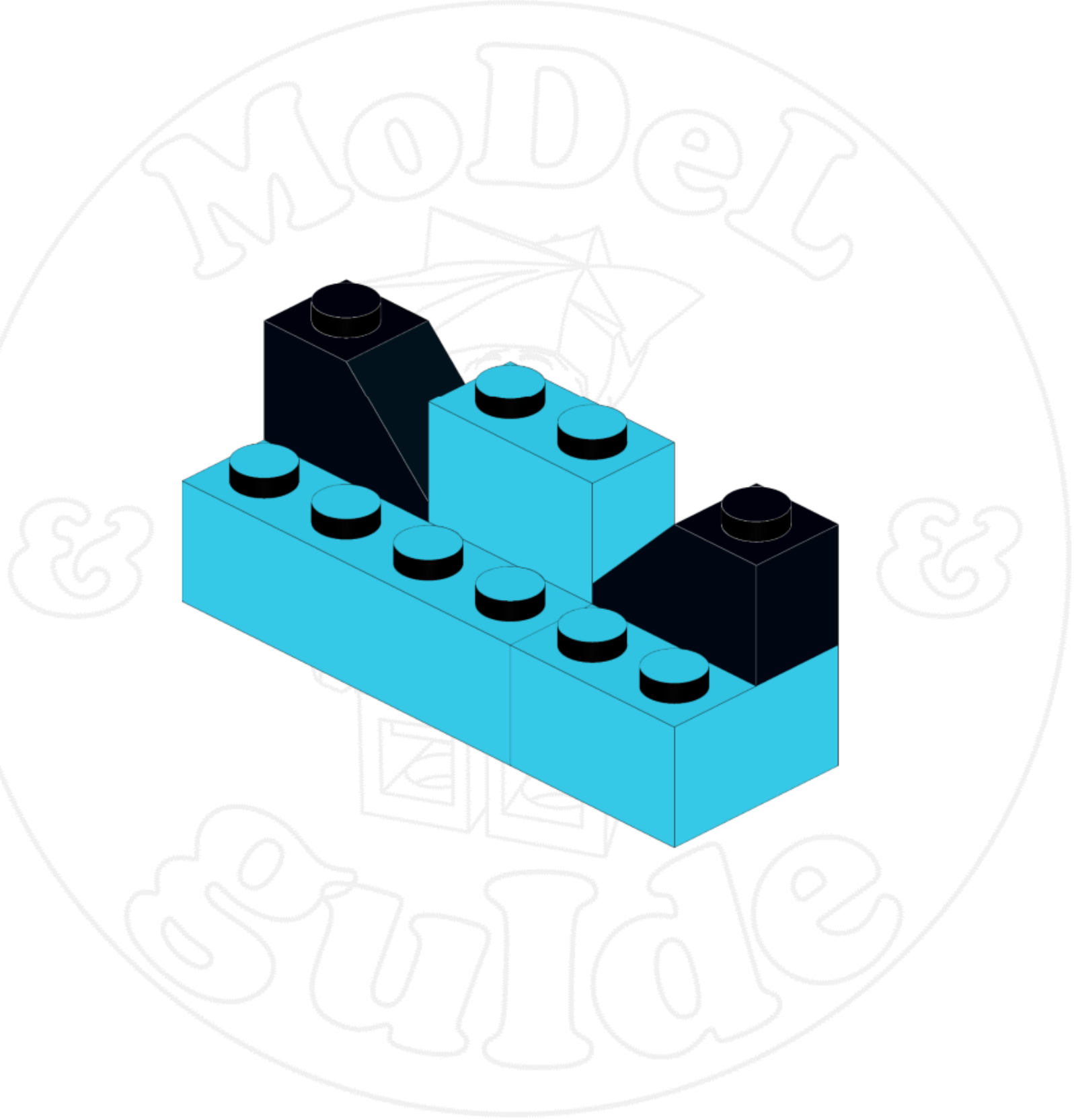
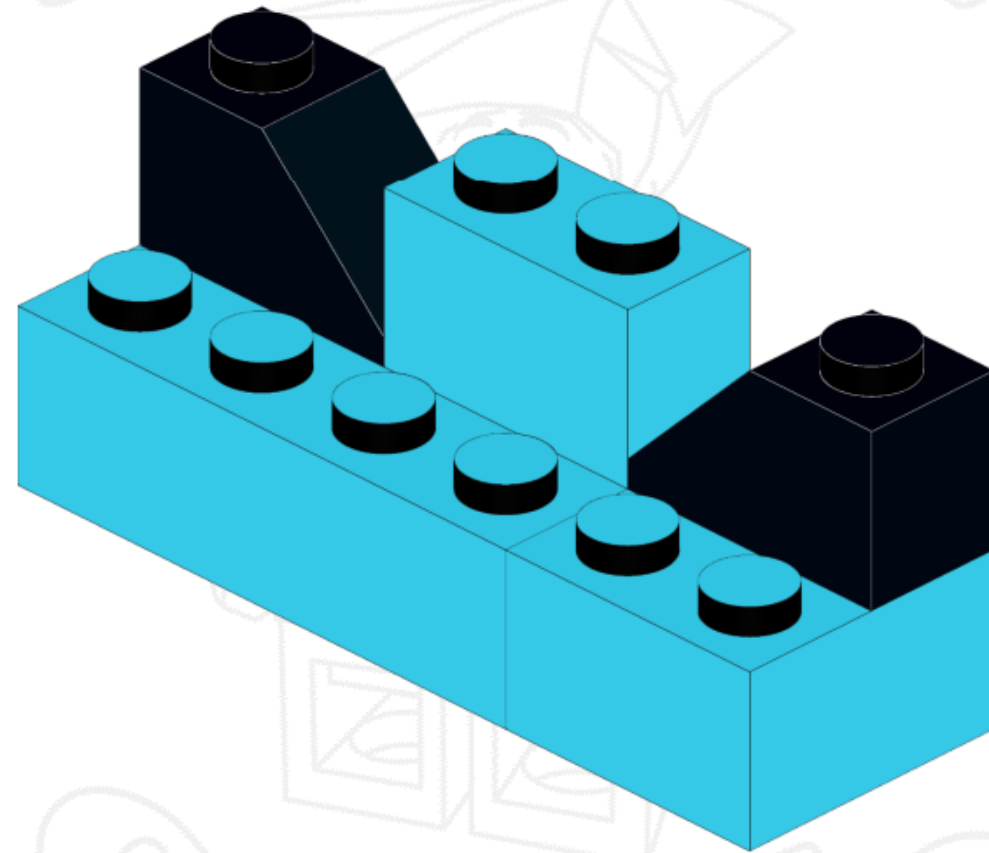

45

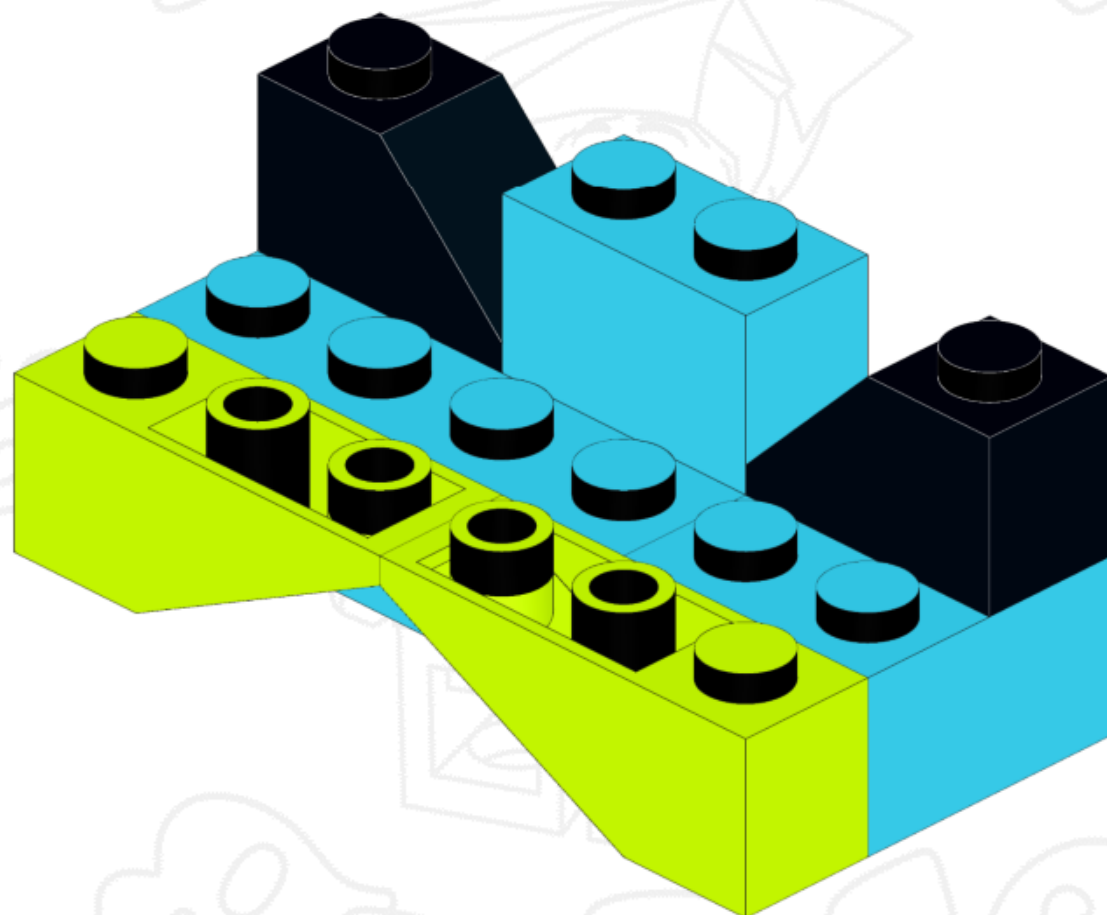
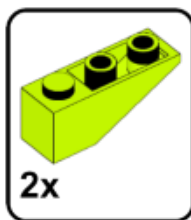

46

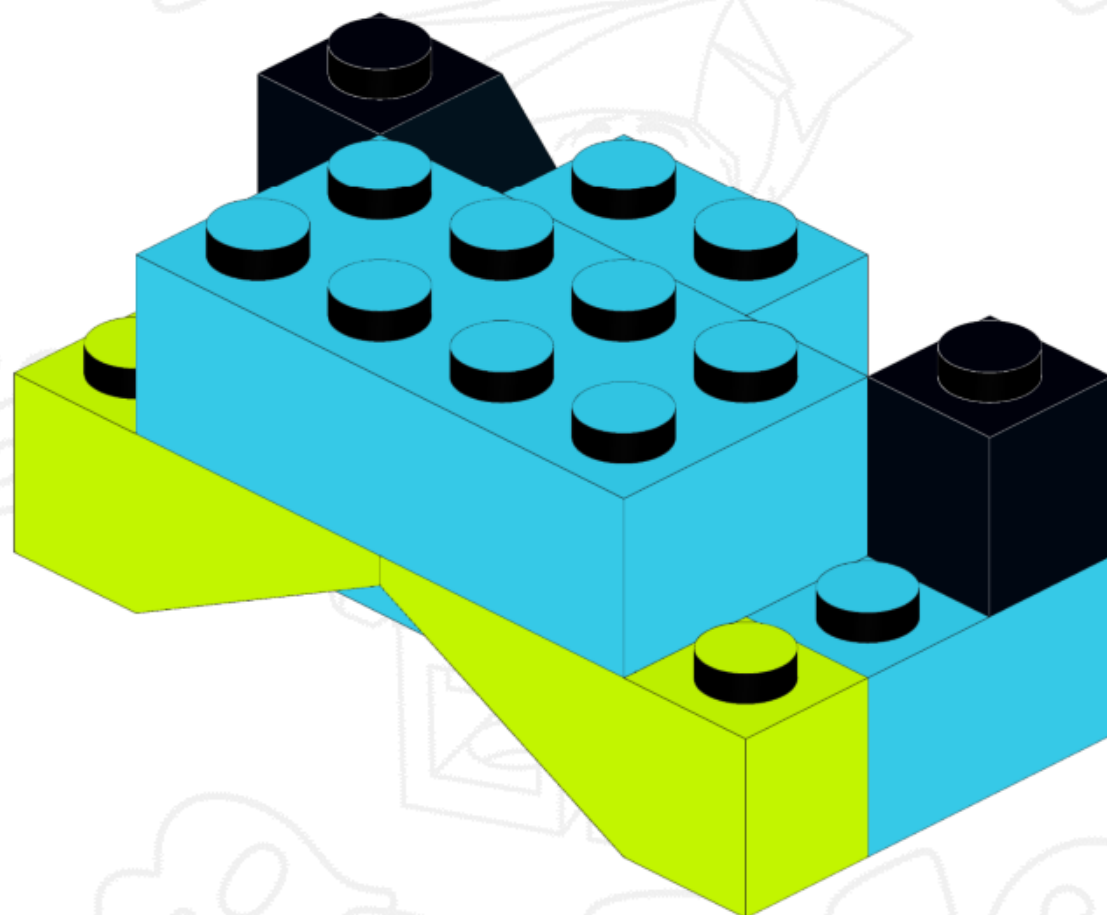
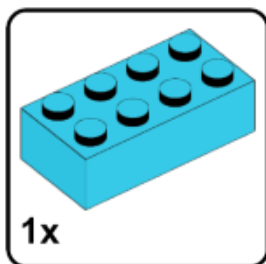

47

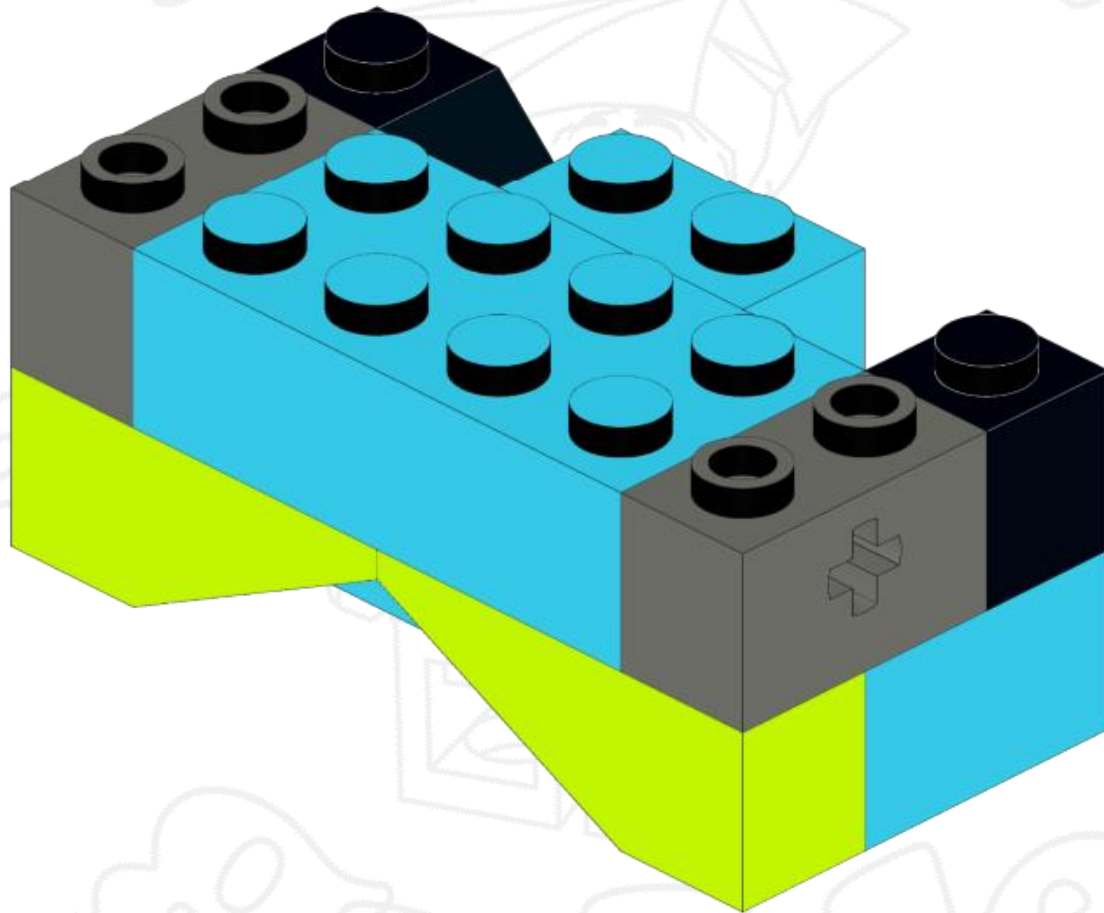
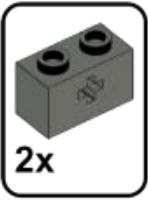

48

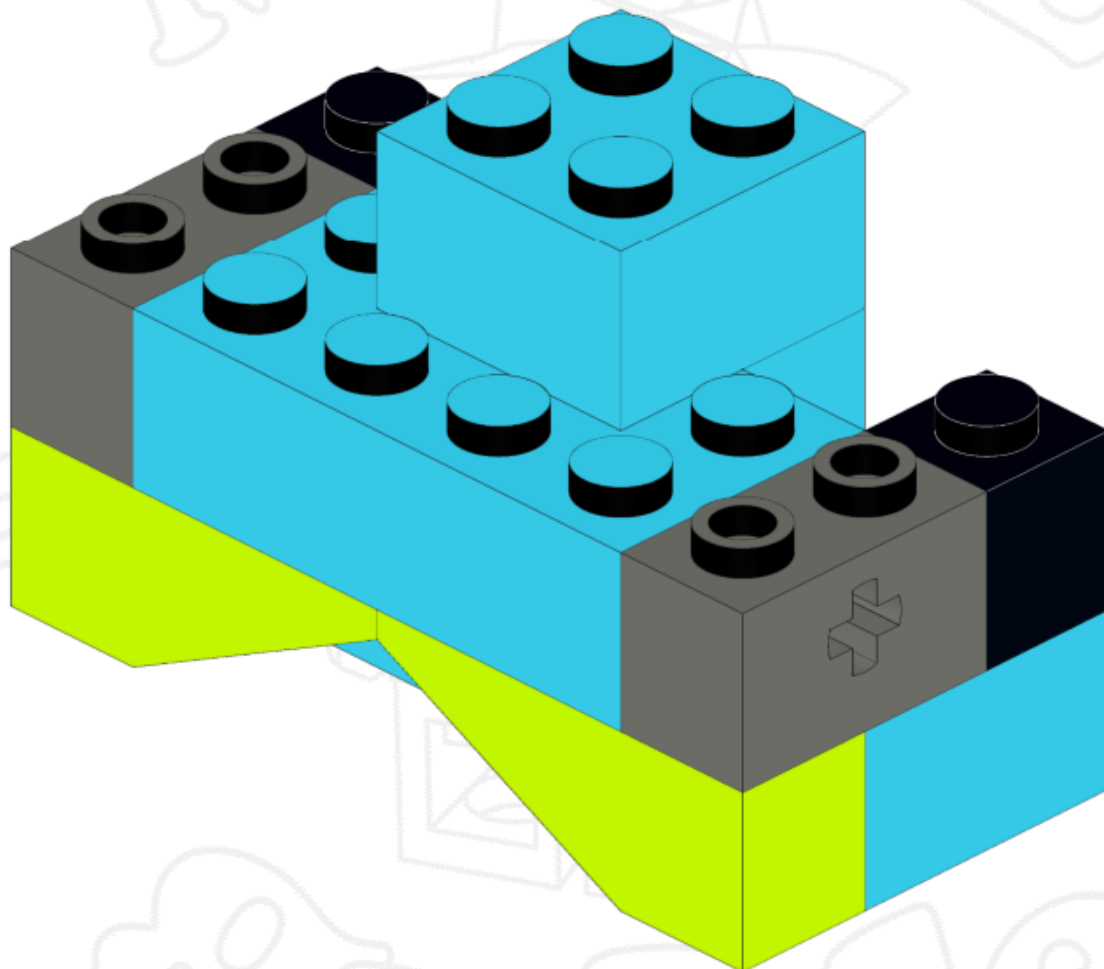
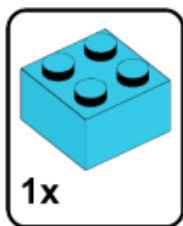

49

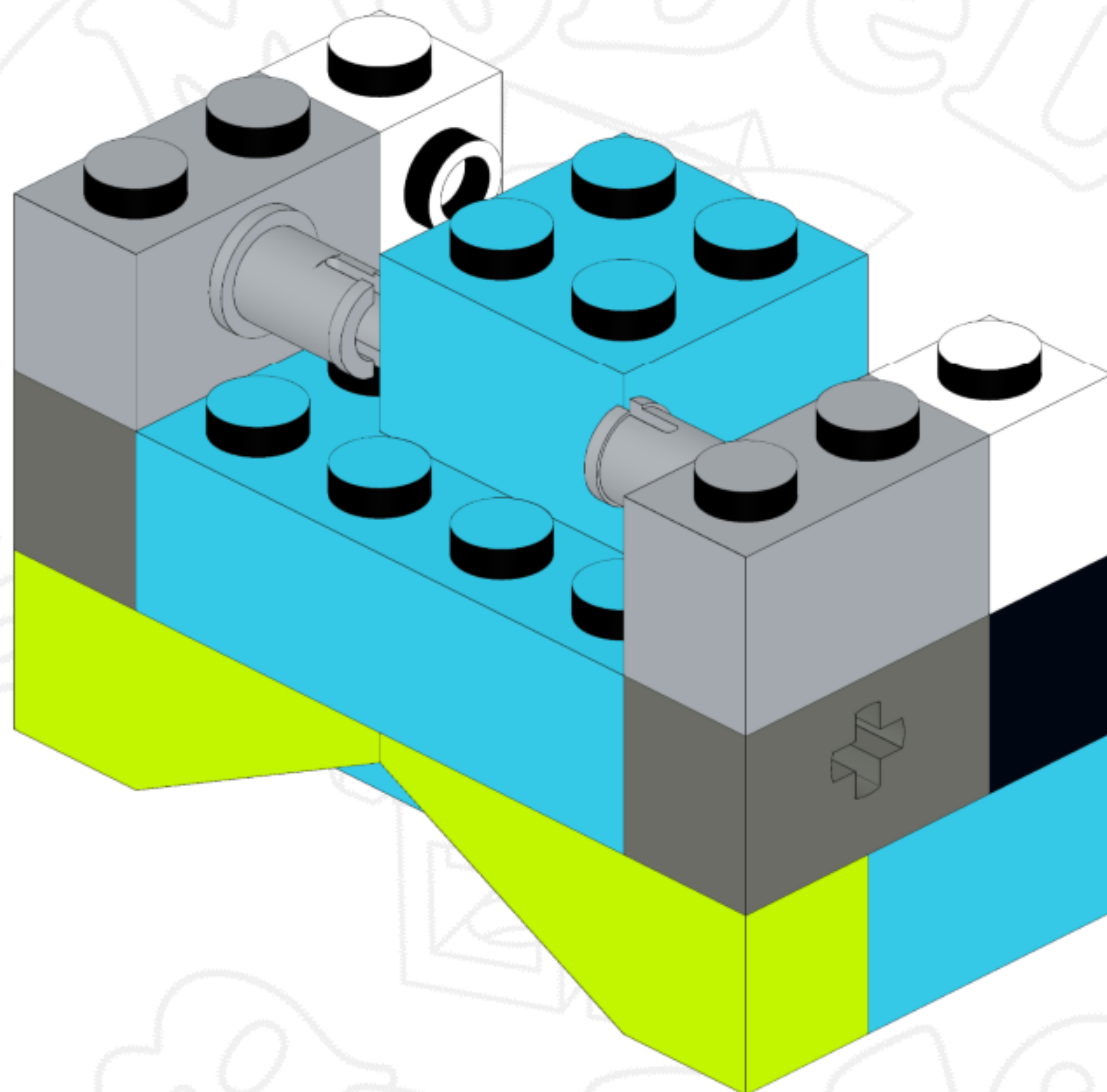
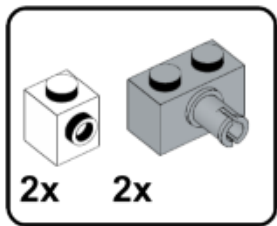

50

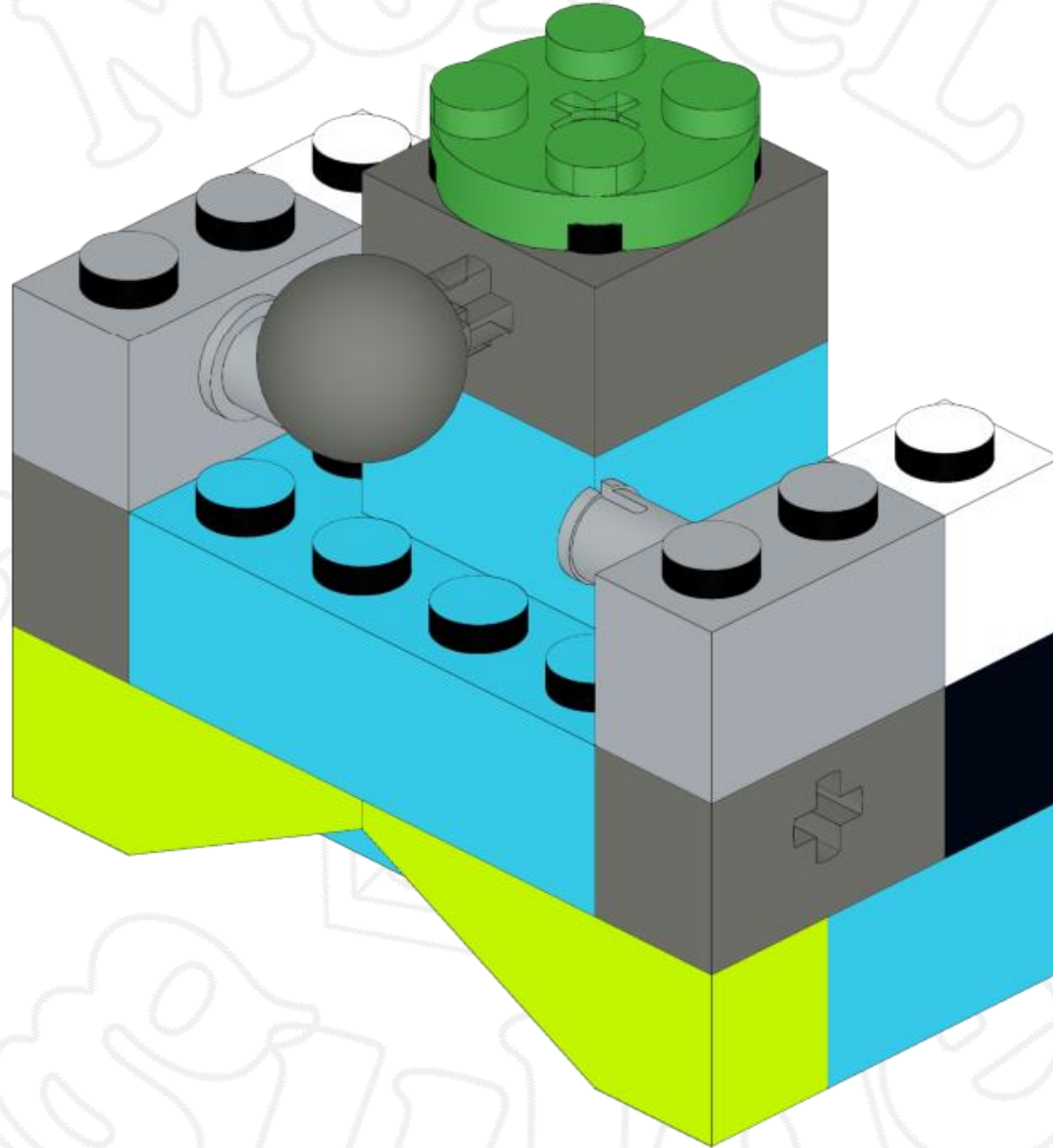
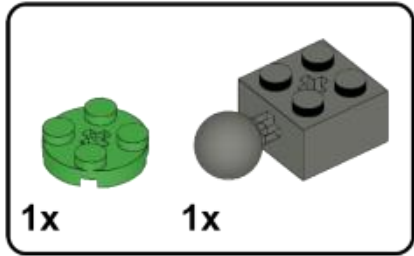

51

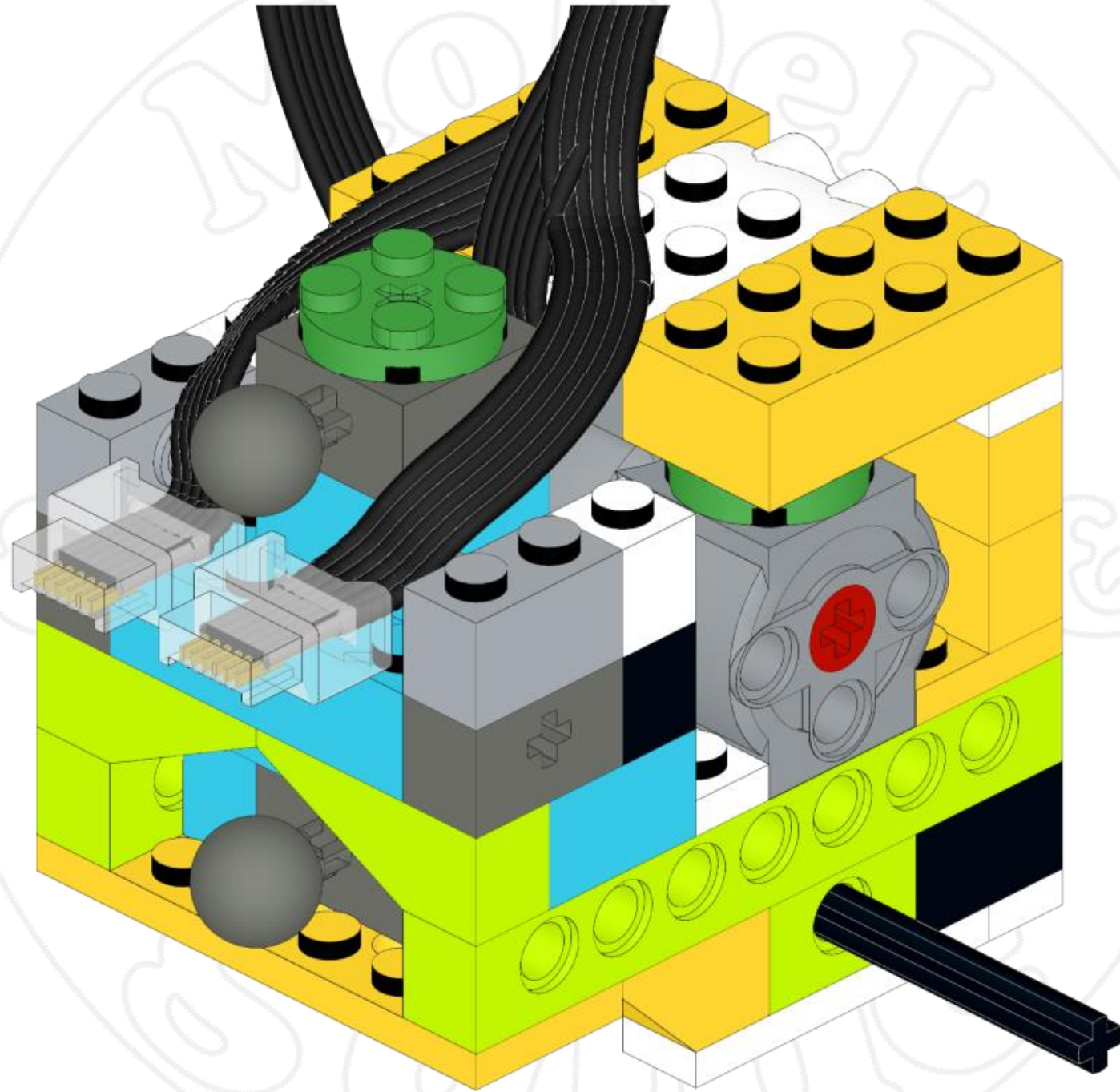
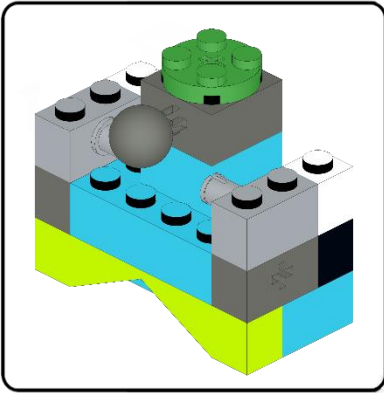

52

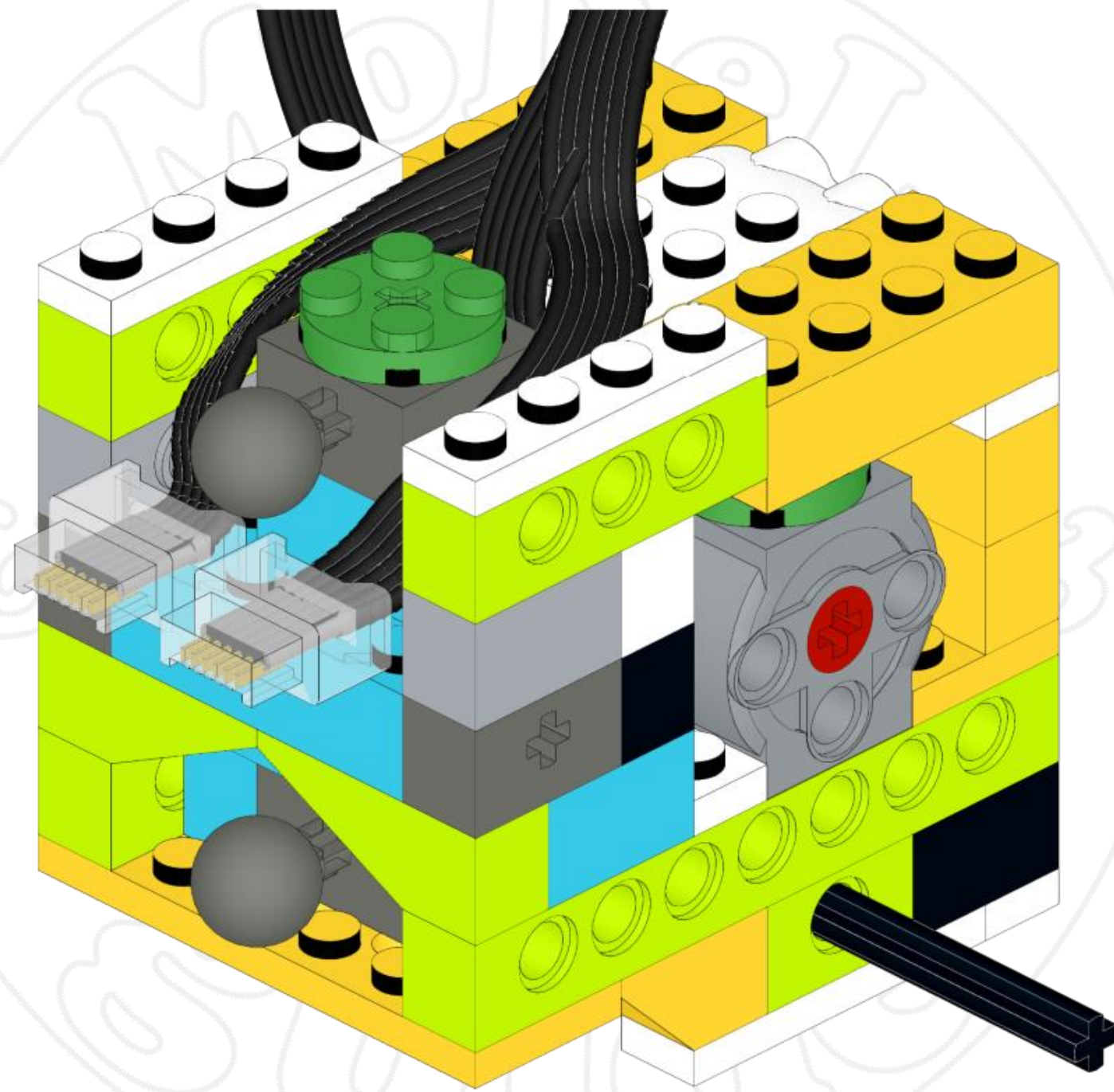
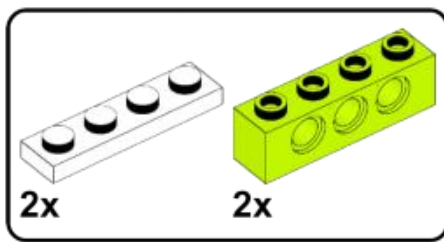

53

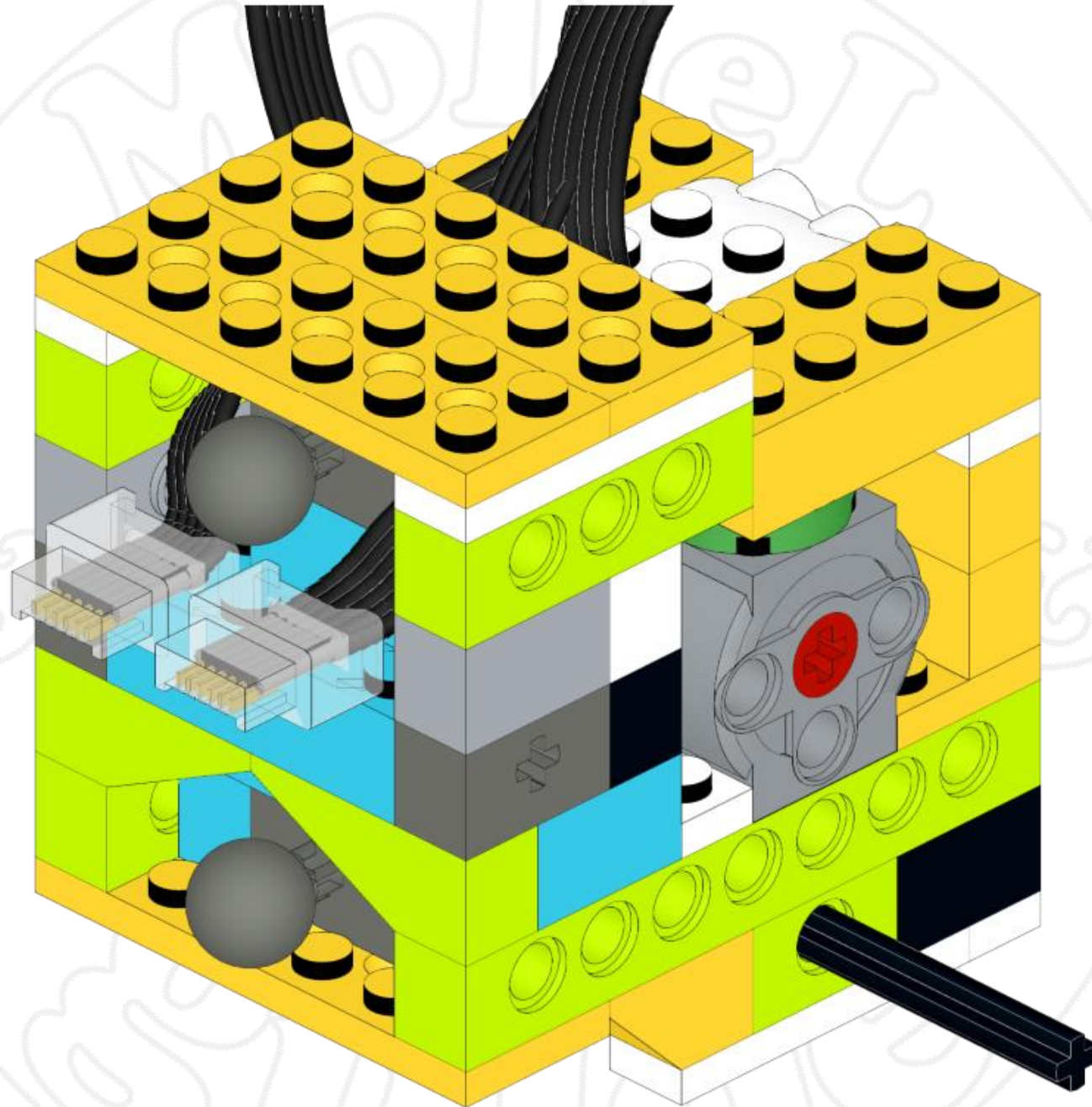
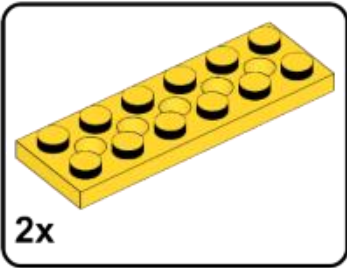

54

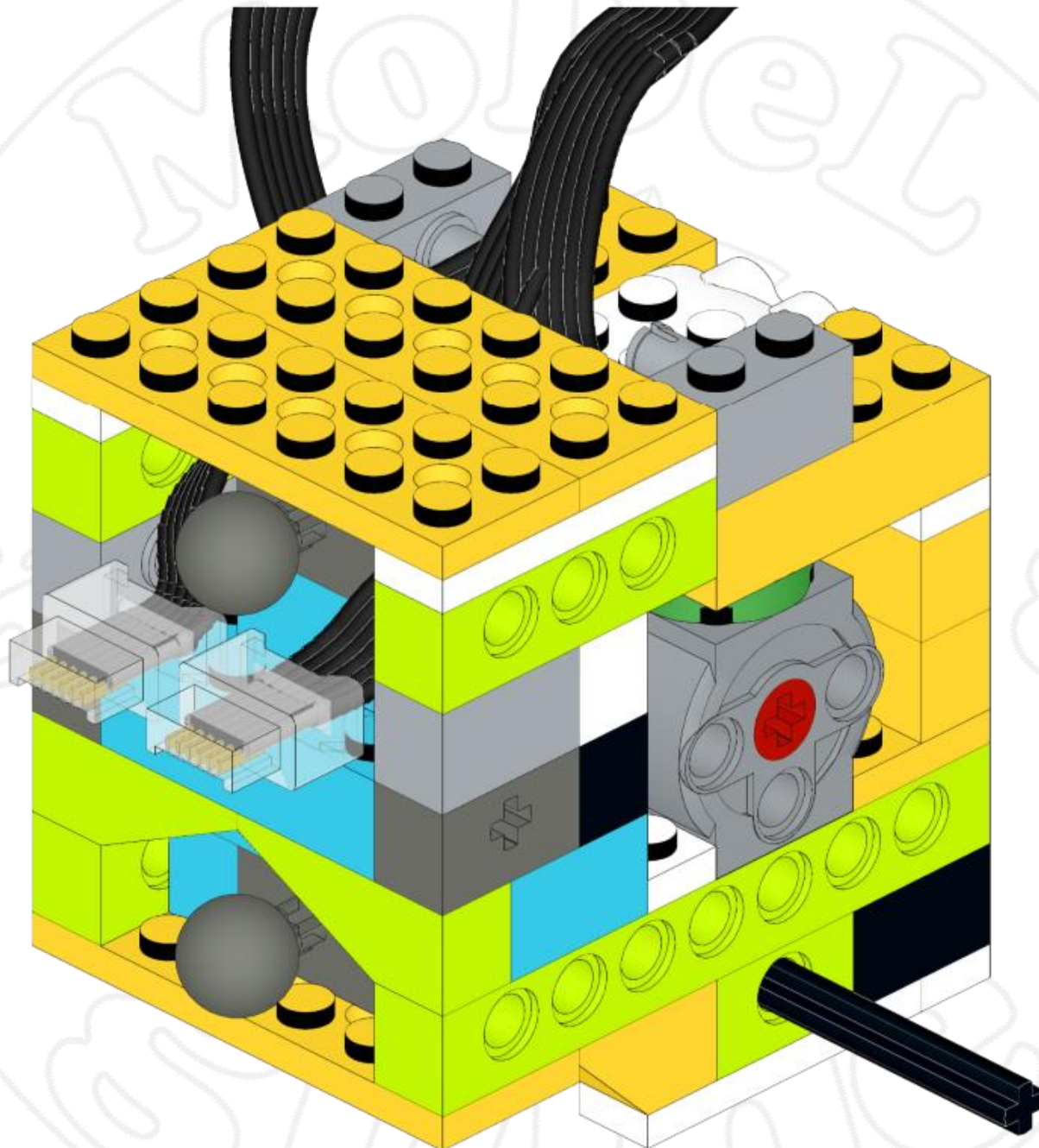
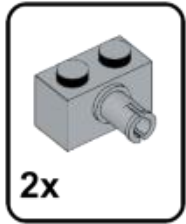

55

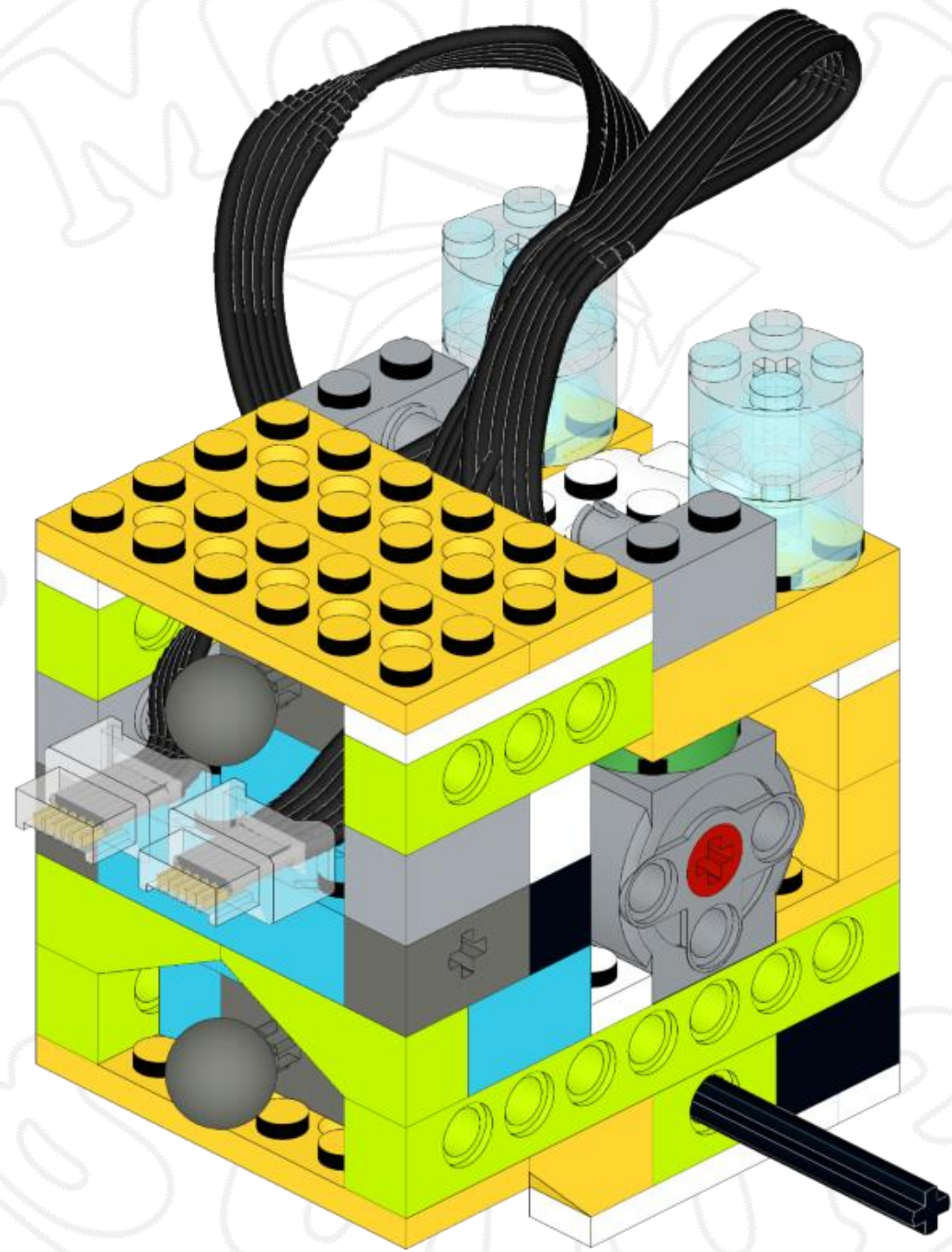
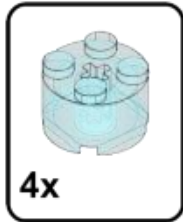

56

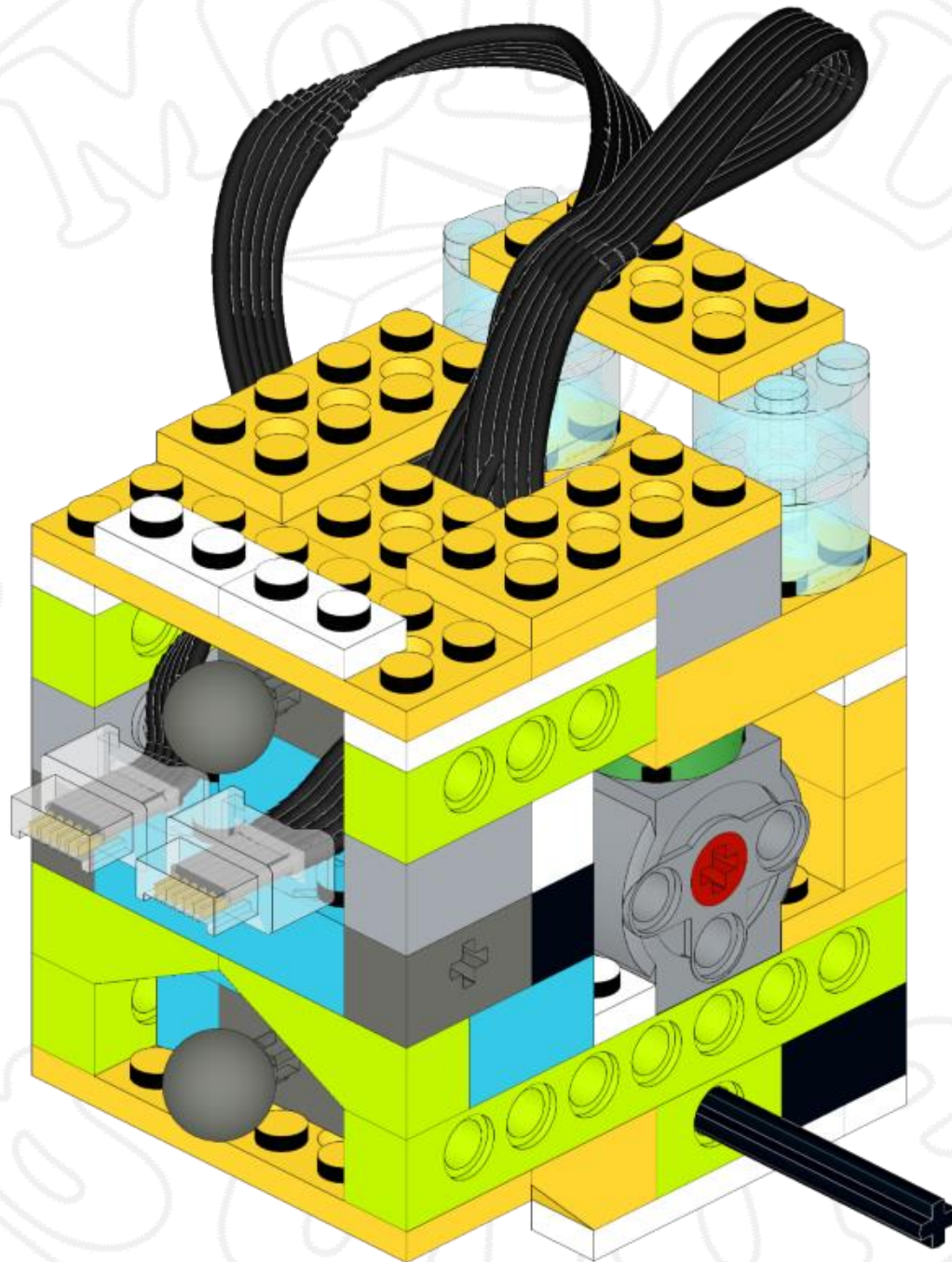
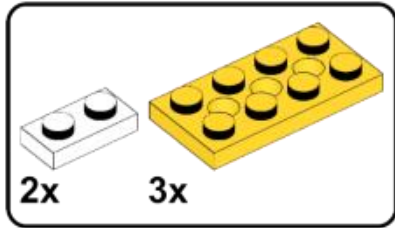

57

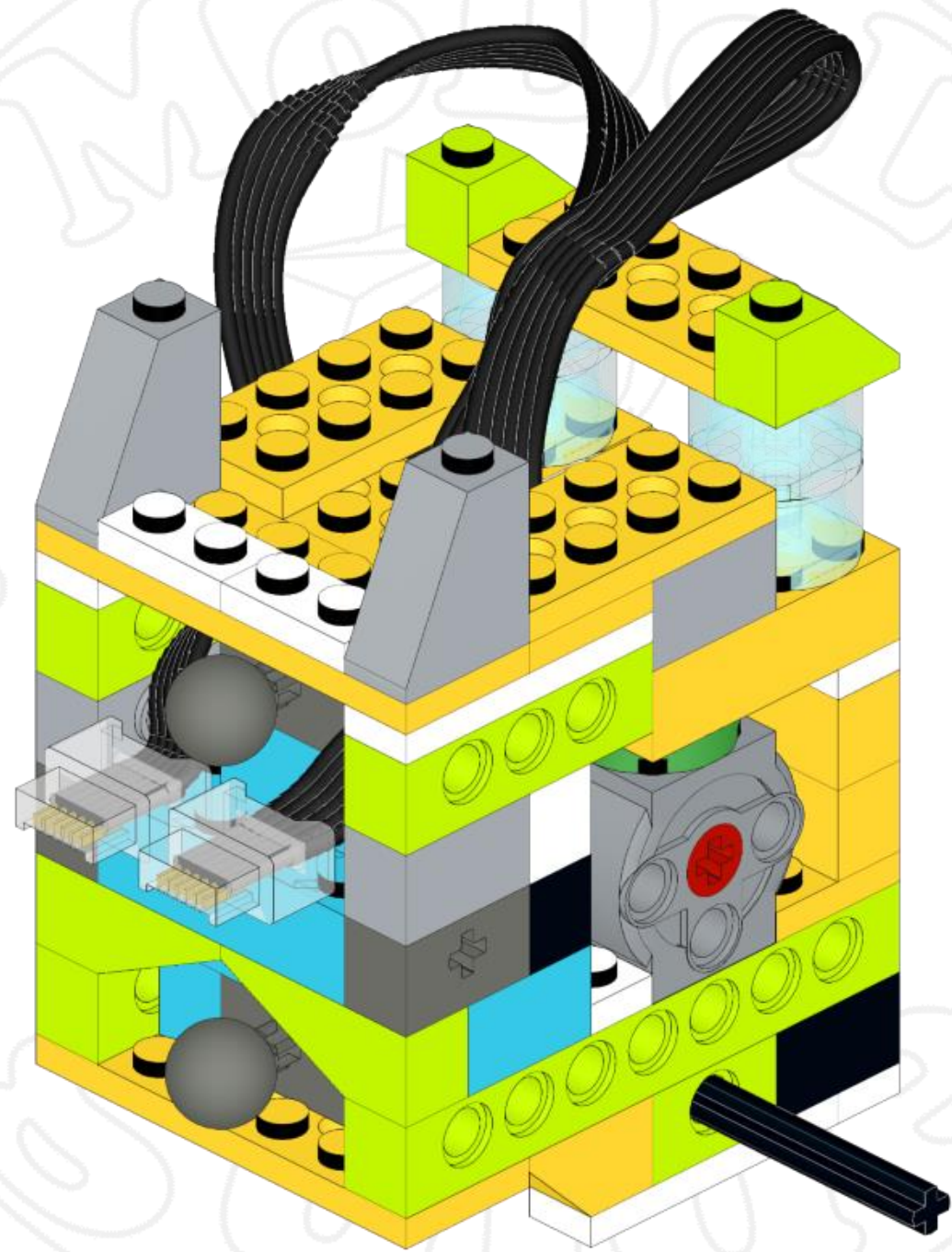
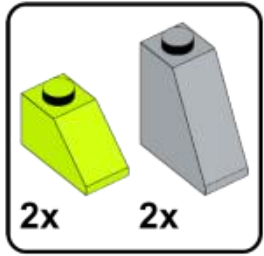

58

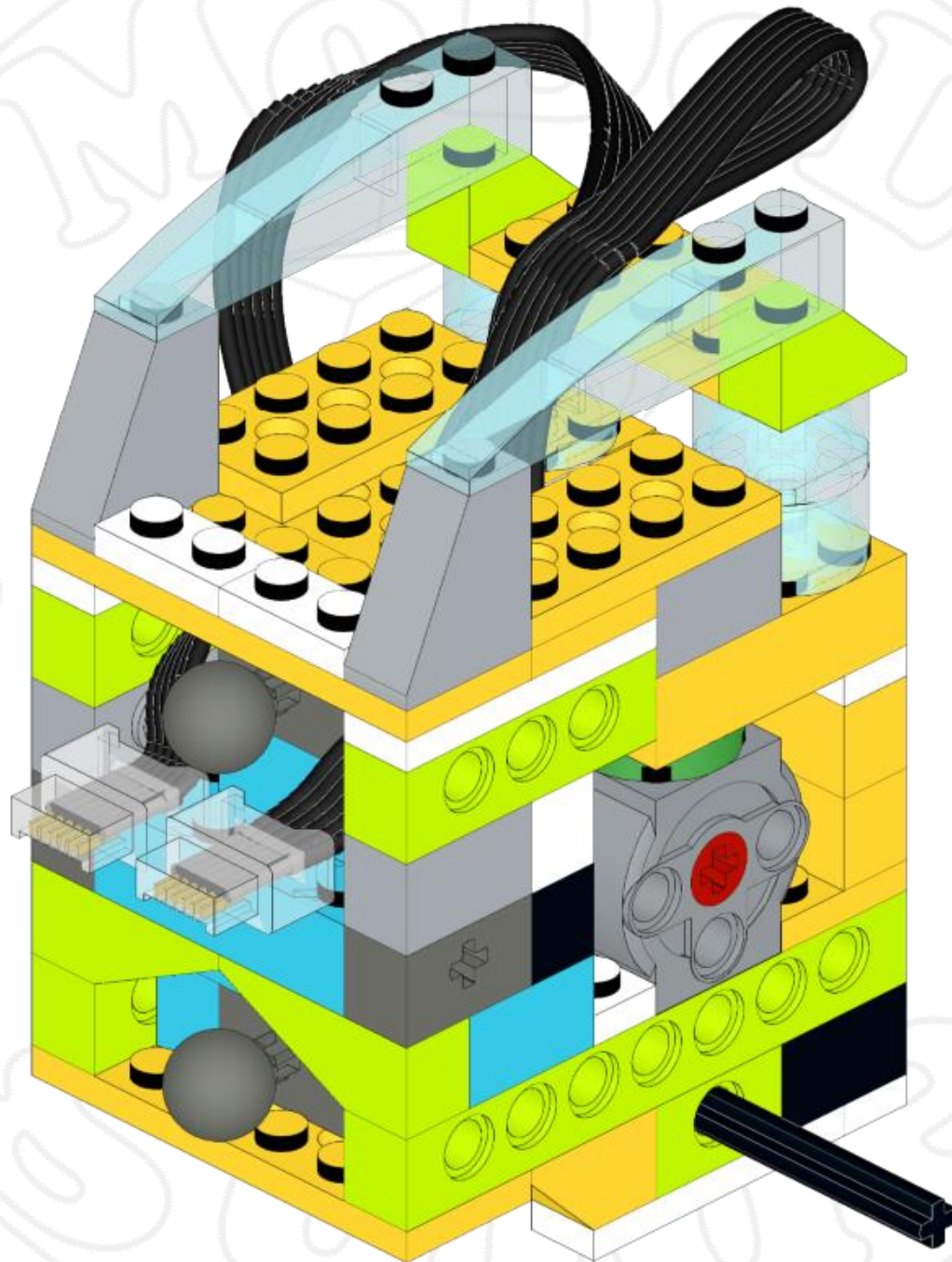
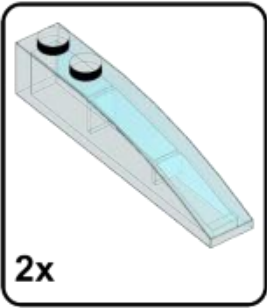

59

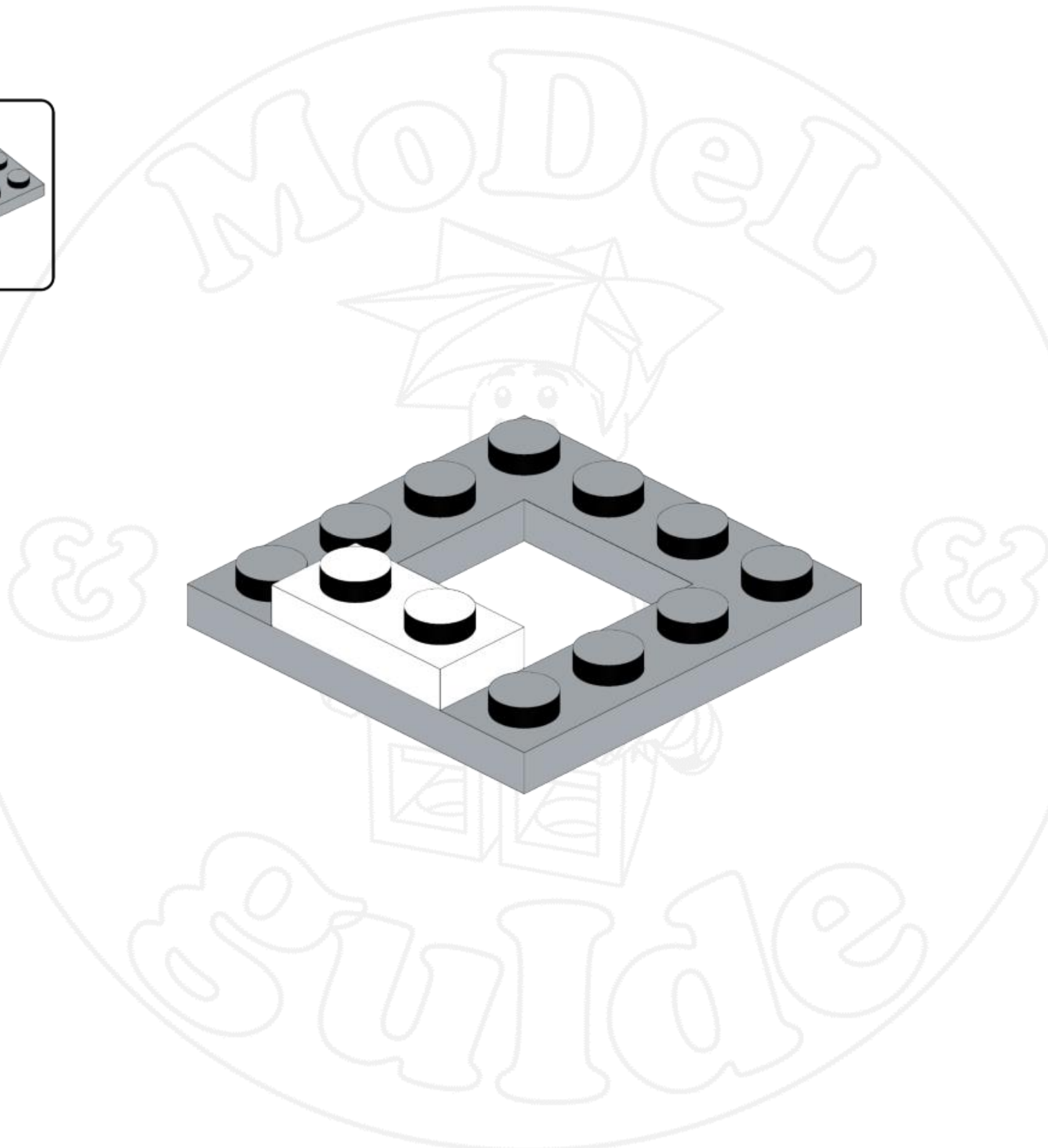
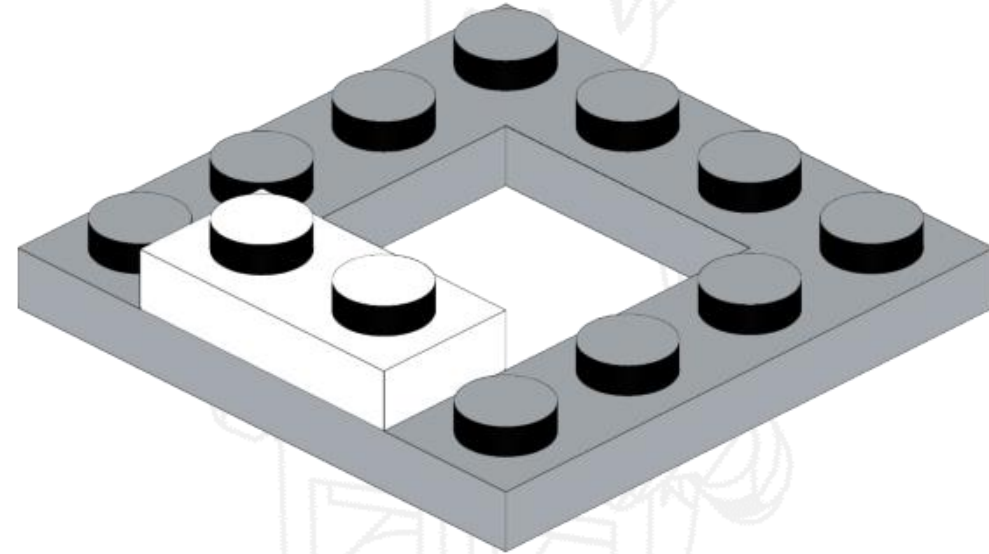
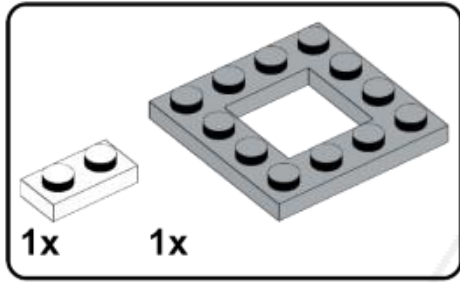

60

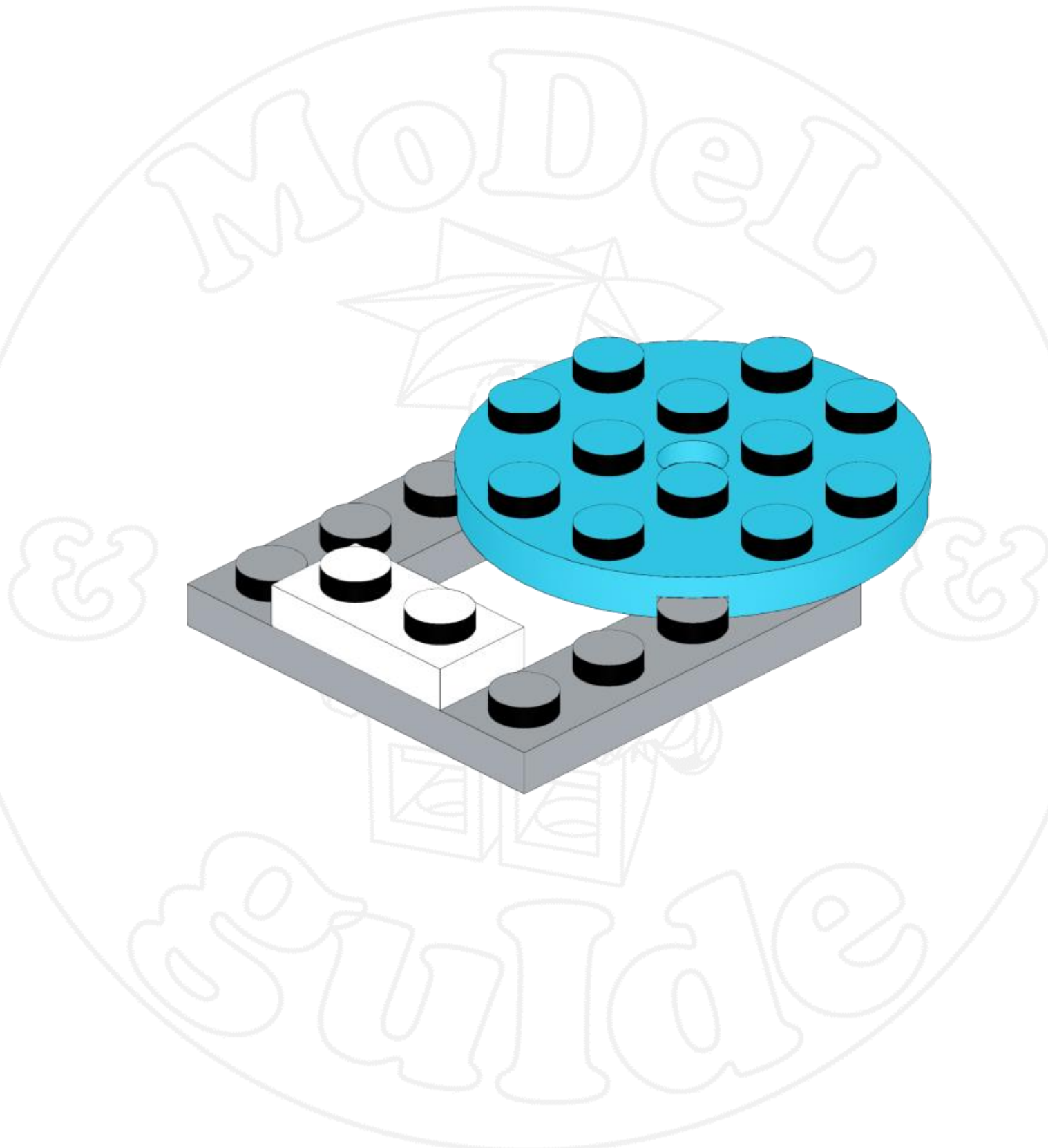
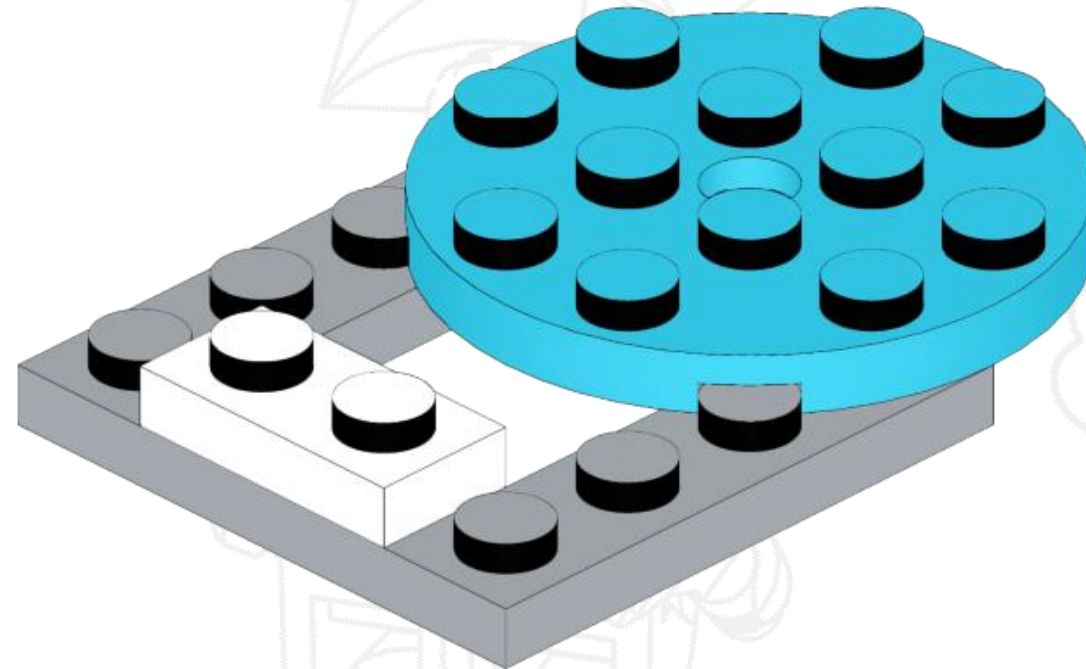
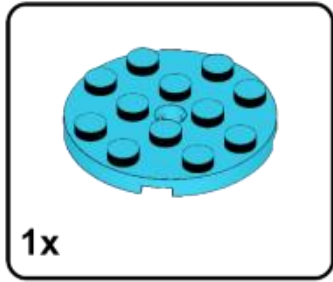

61

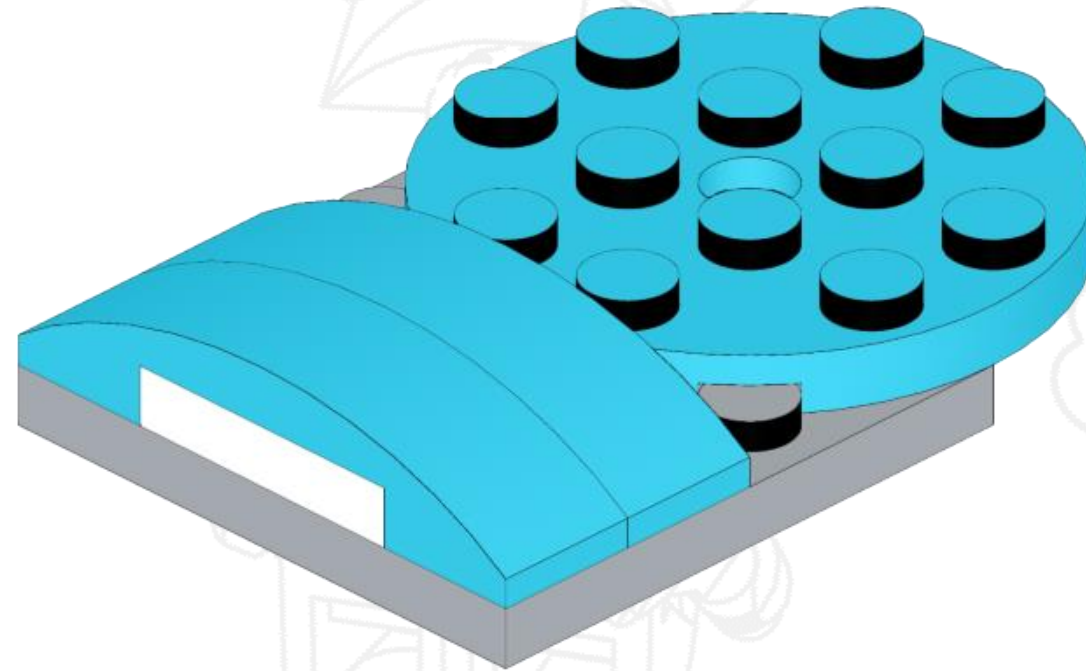
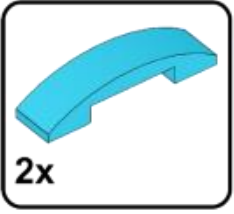

Build Guide

62

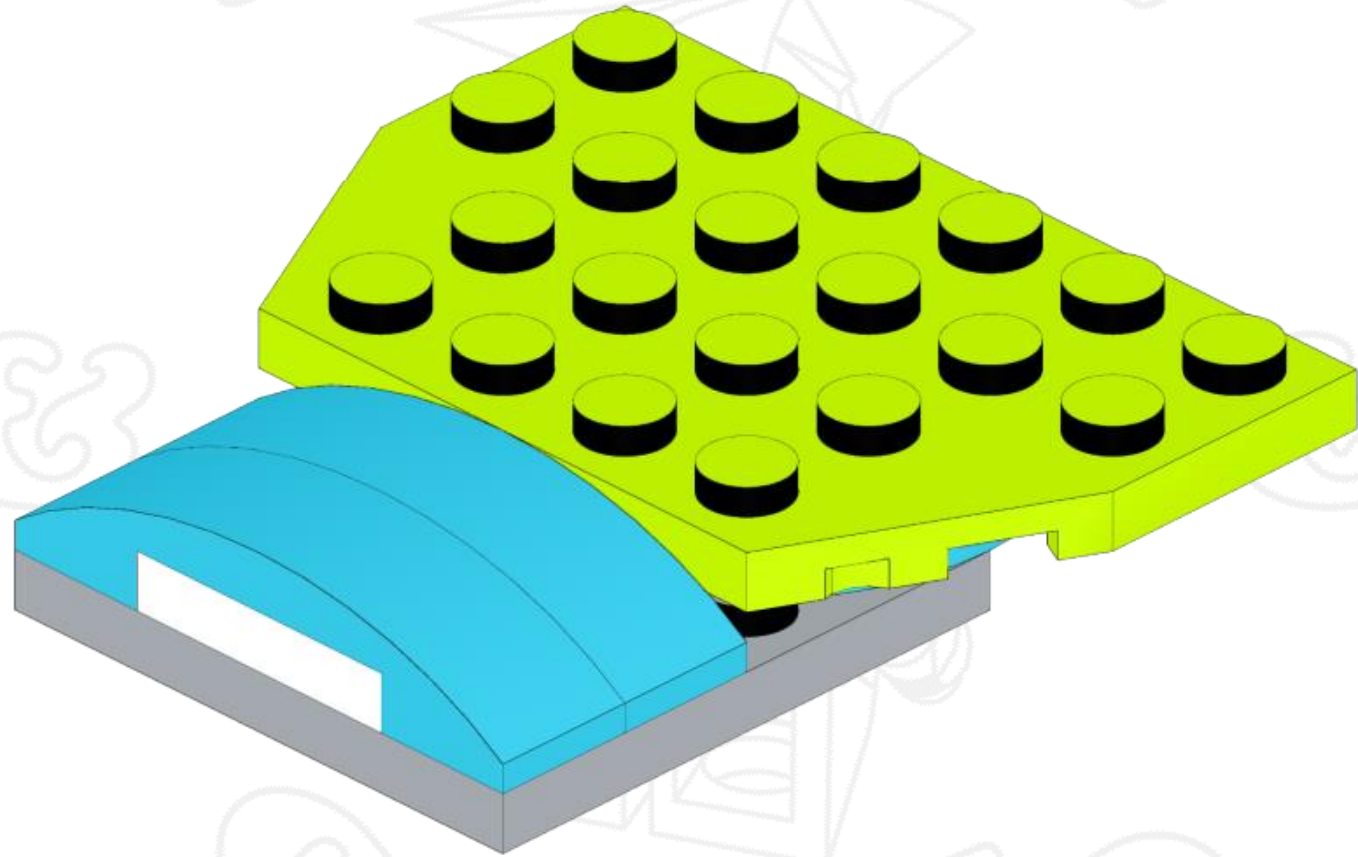
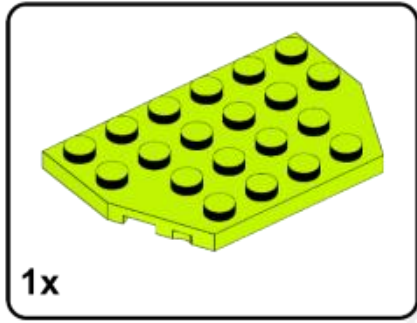

Model

Guide

63

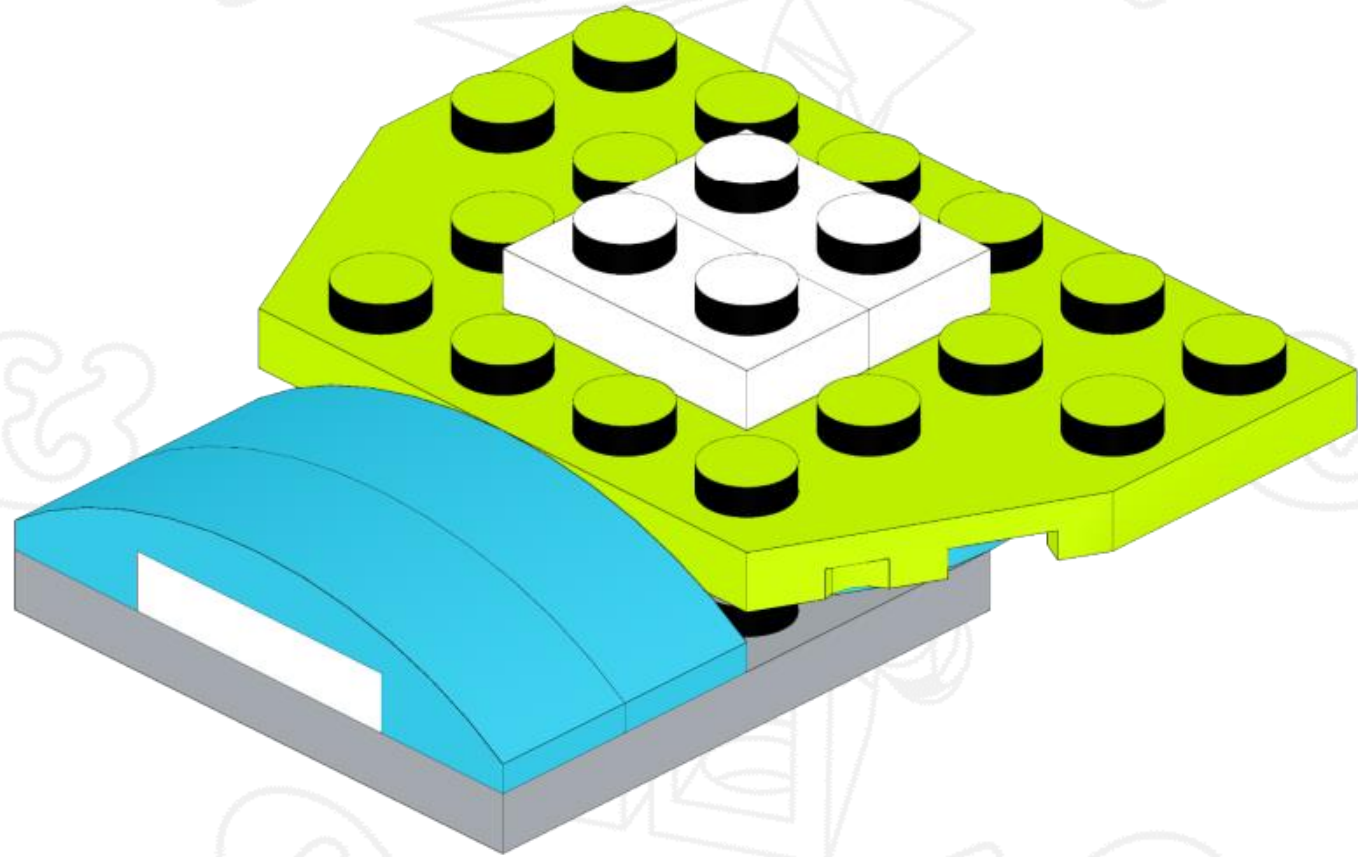
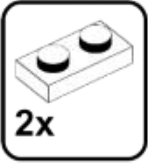

64

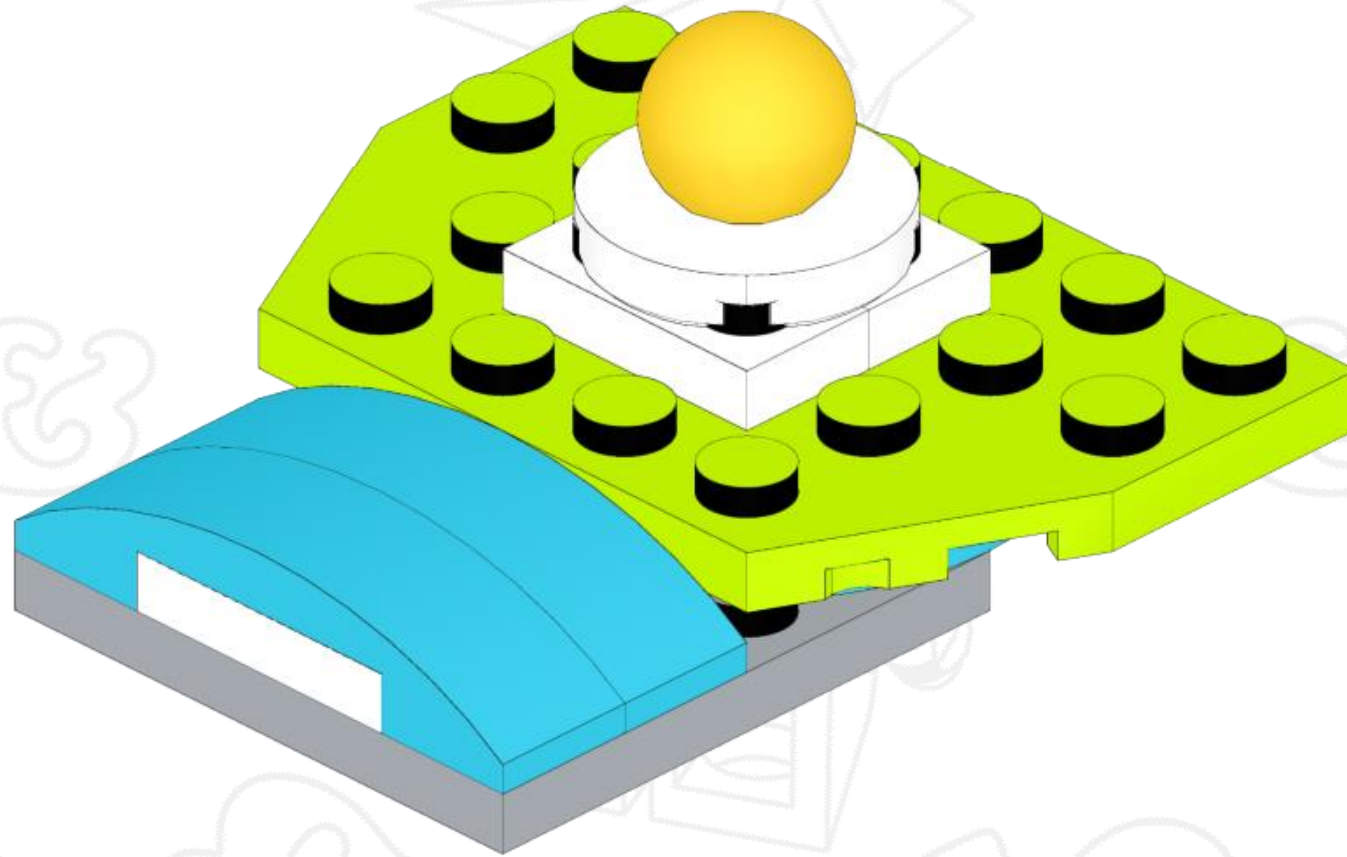
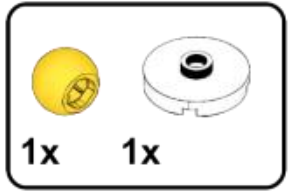

Model

Guide

65

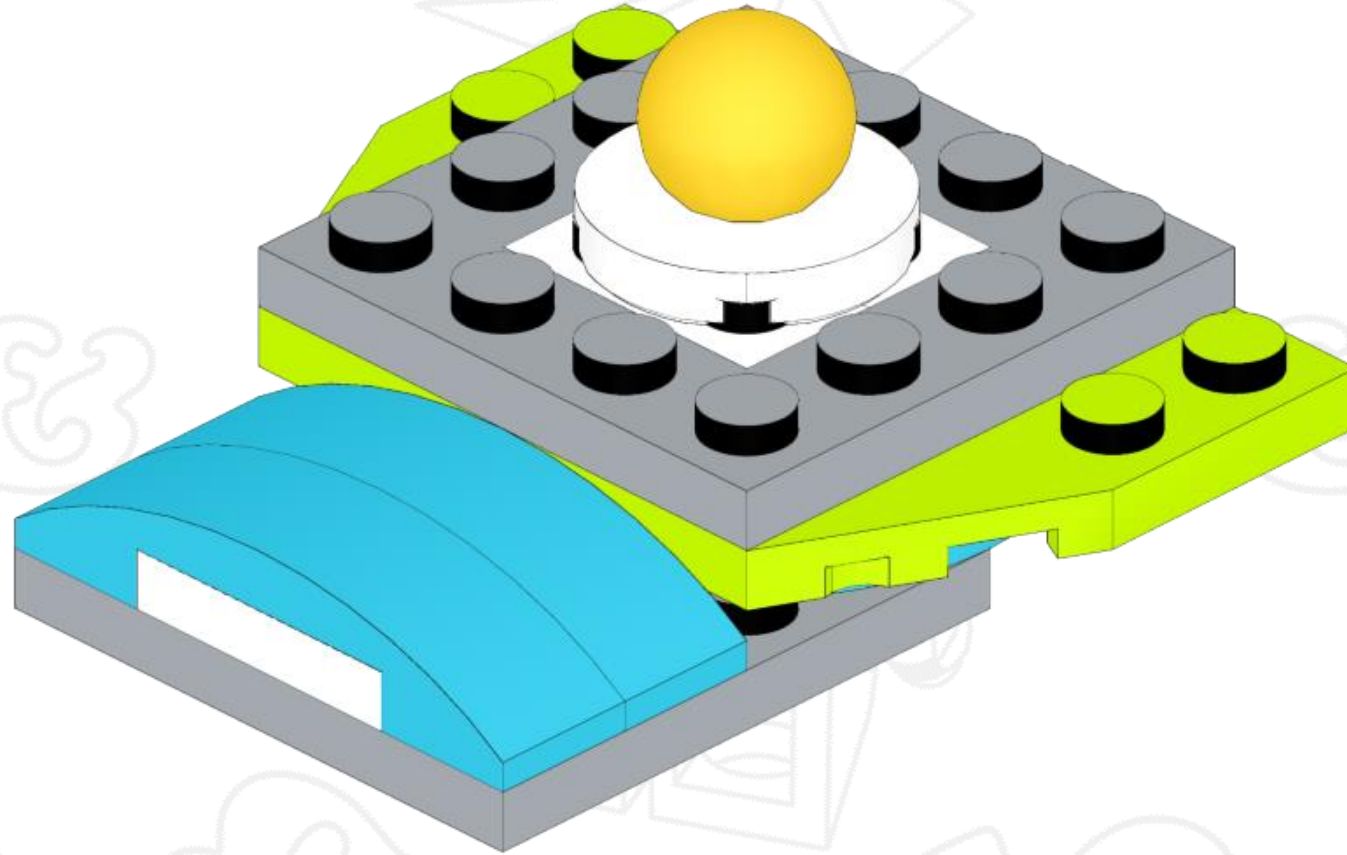
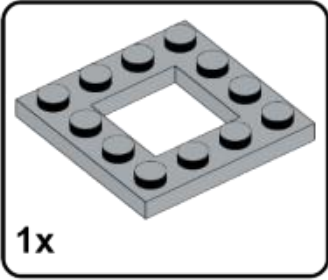

Model

Guide

66

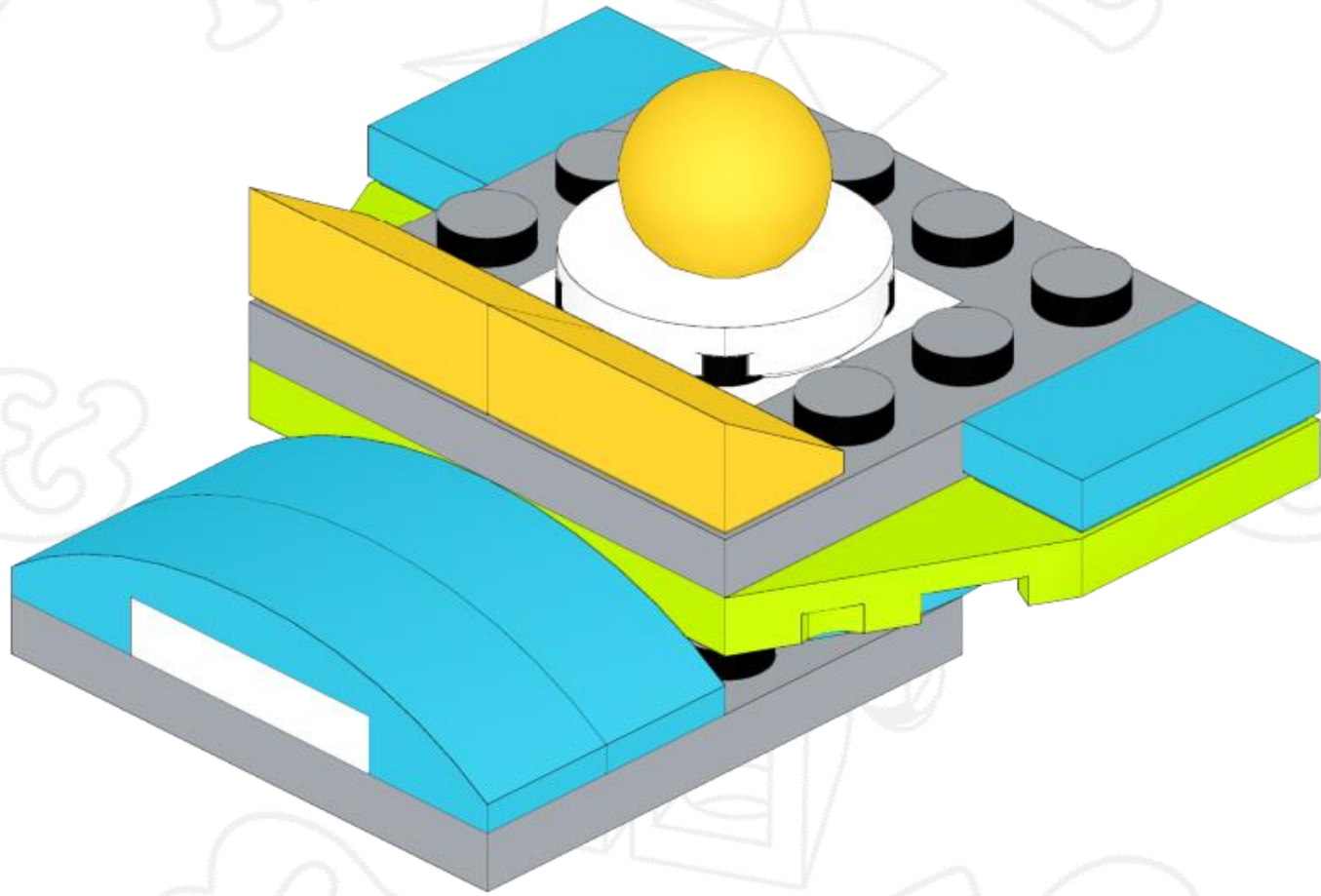
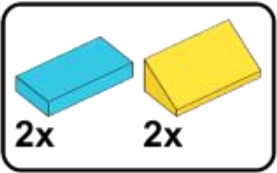

67

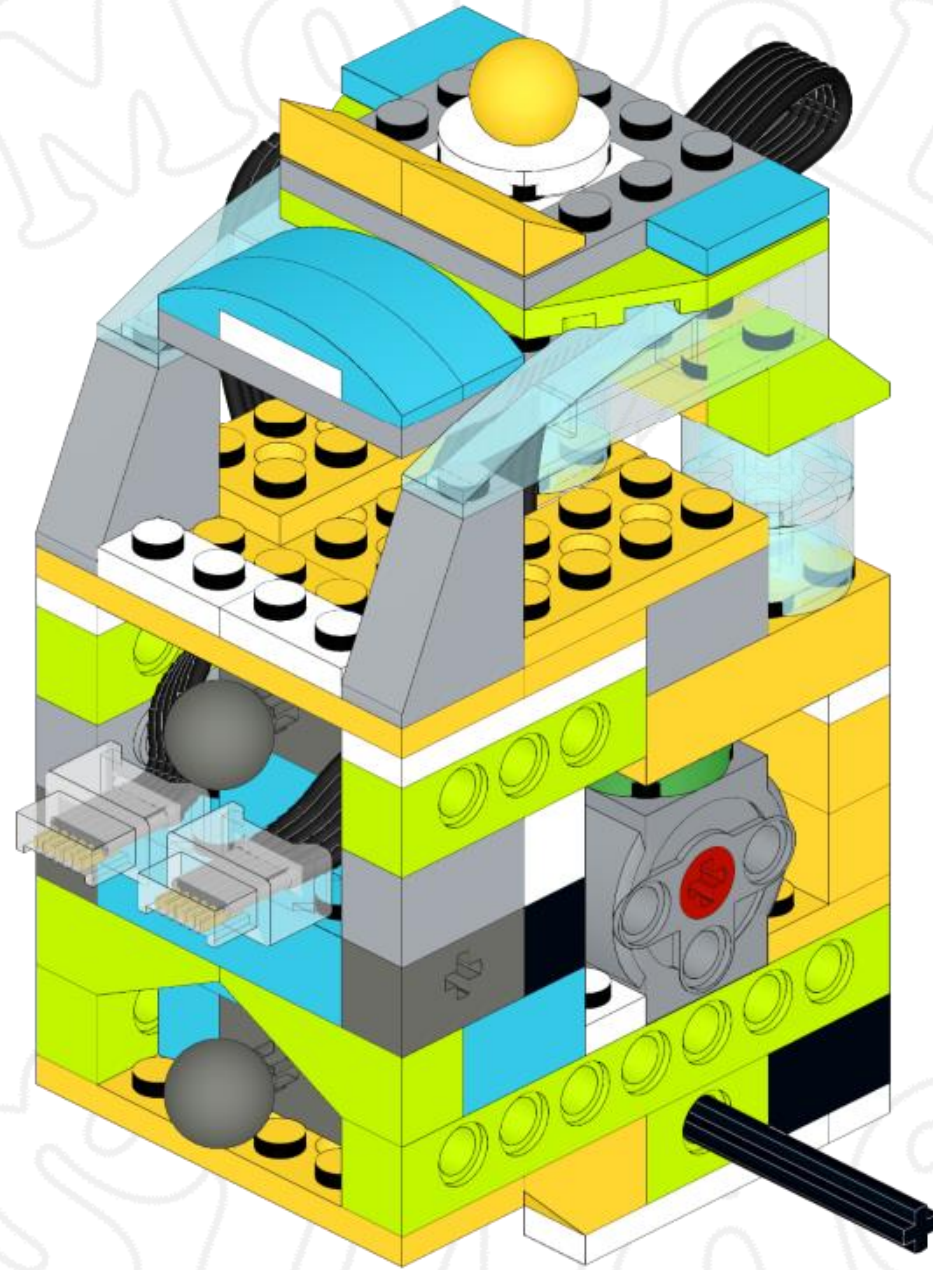
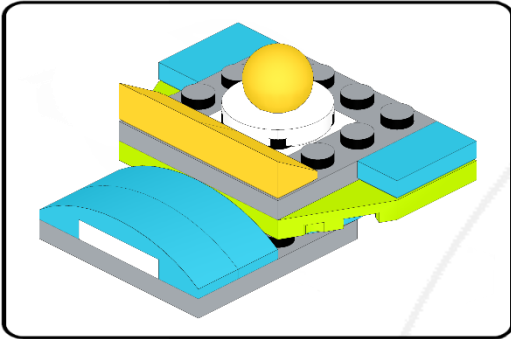

68

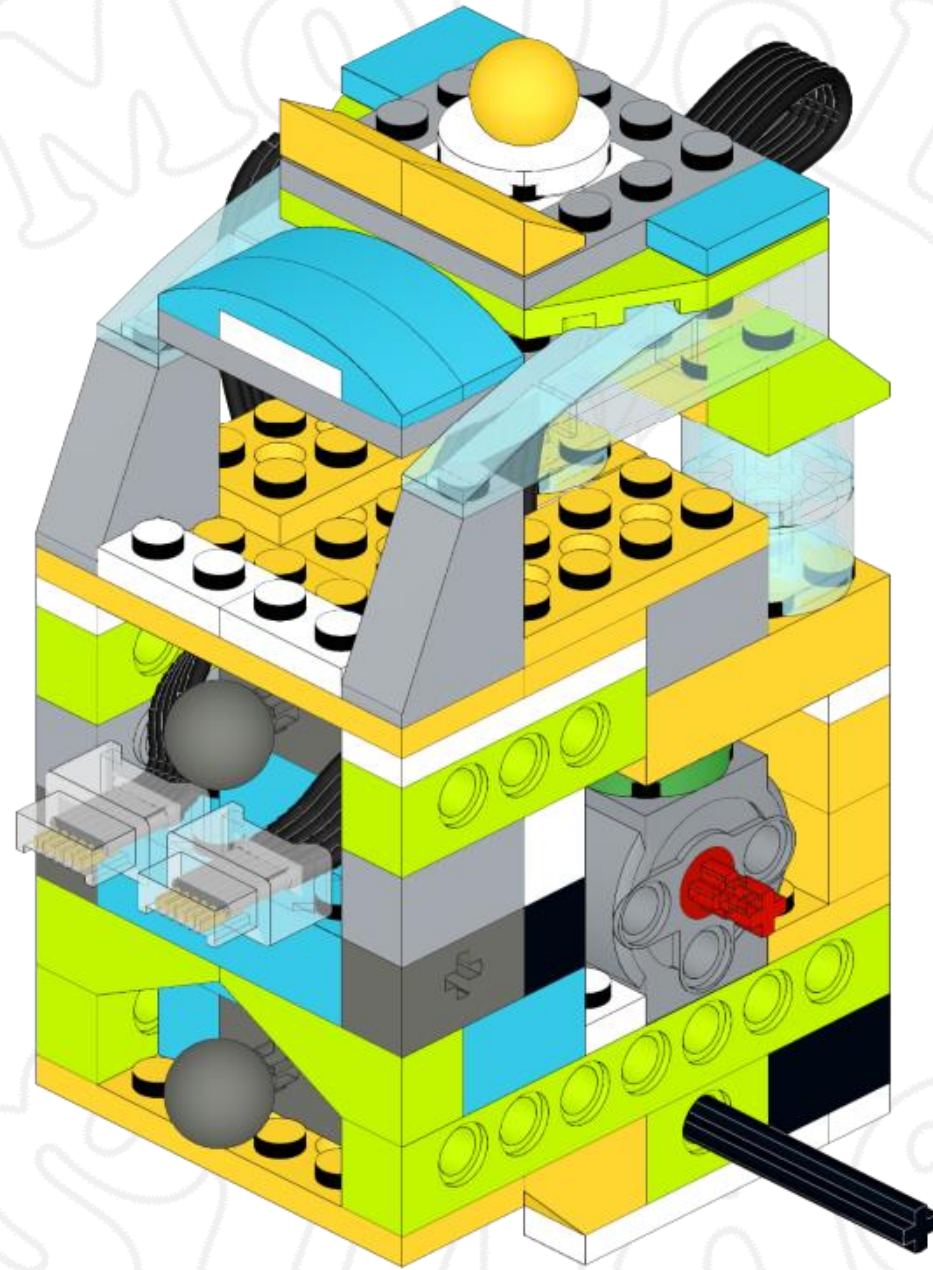

69

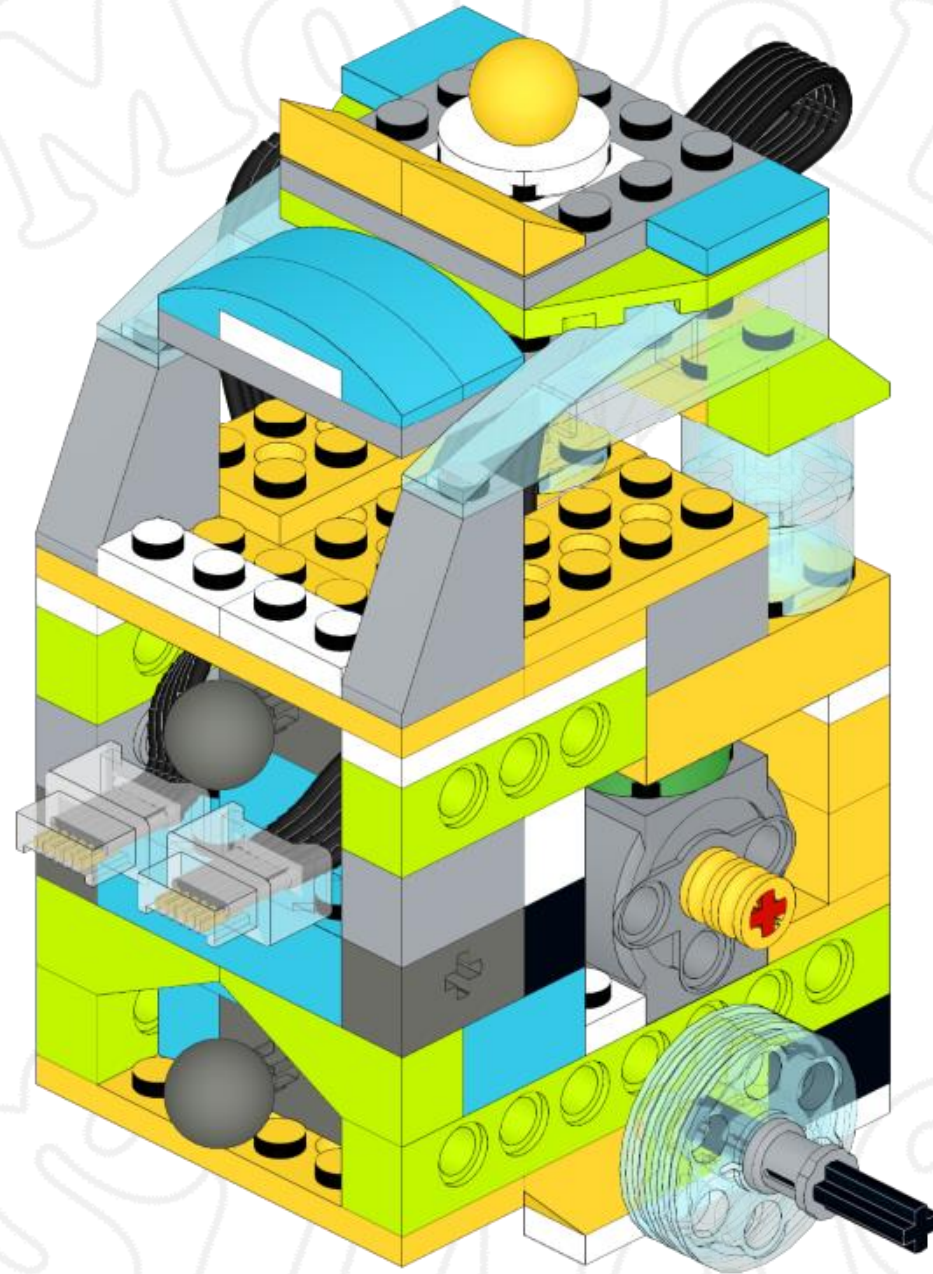
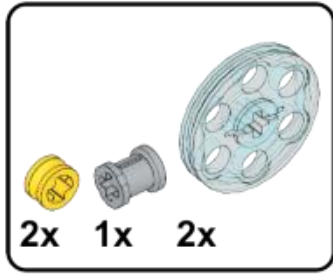

70

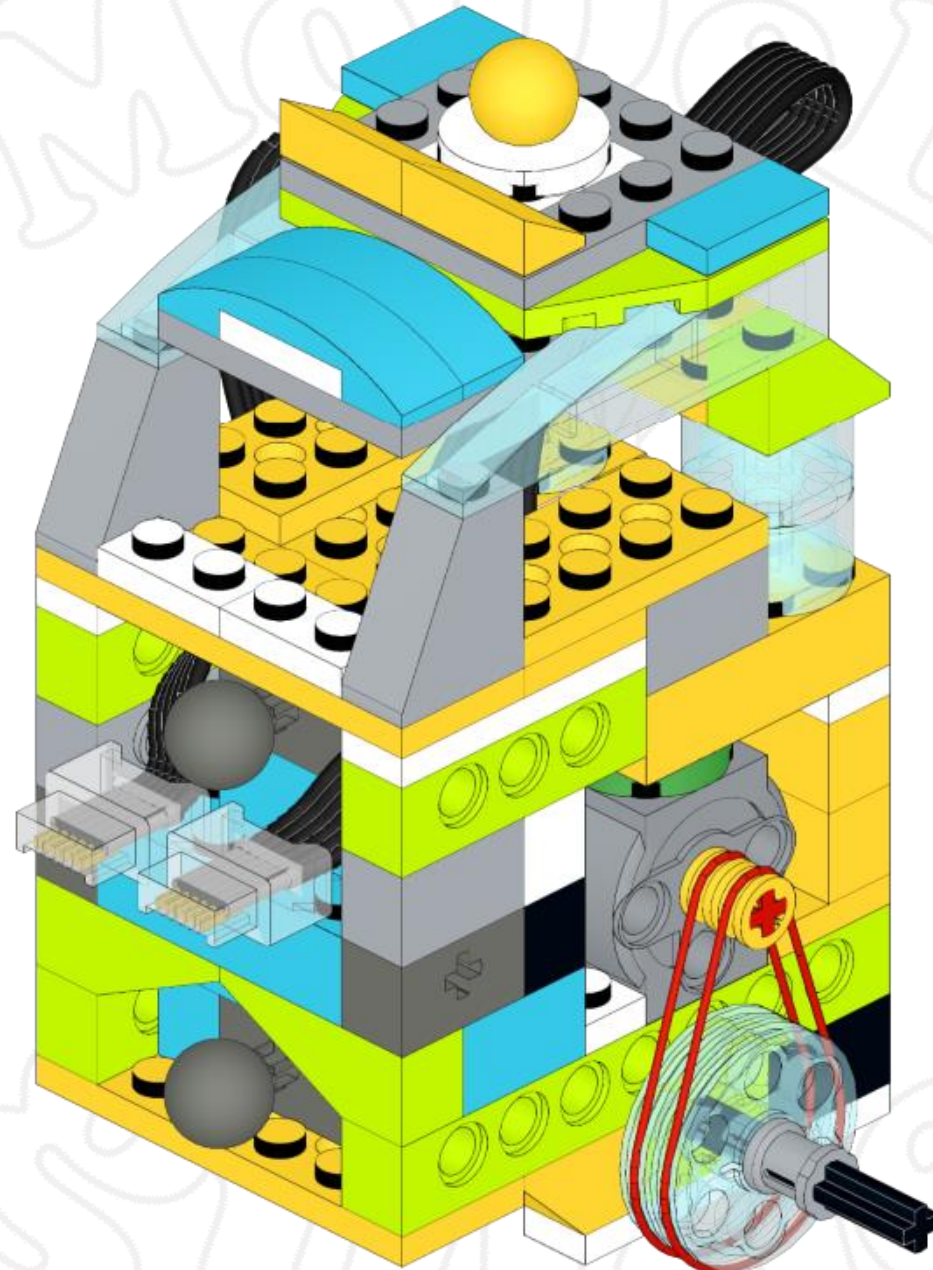
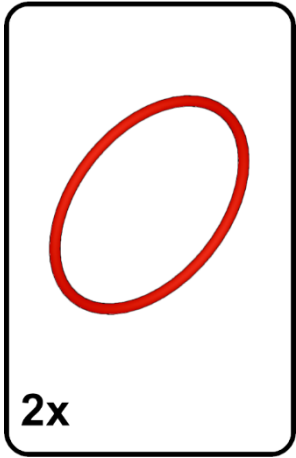

71

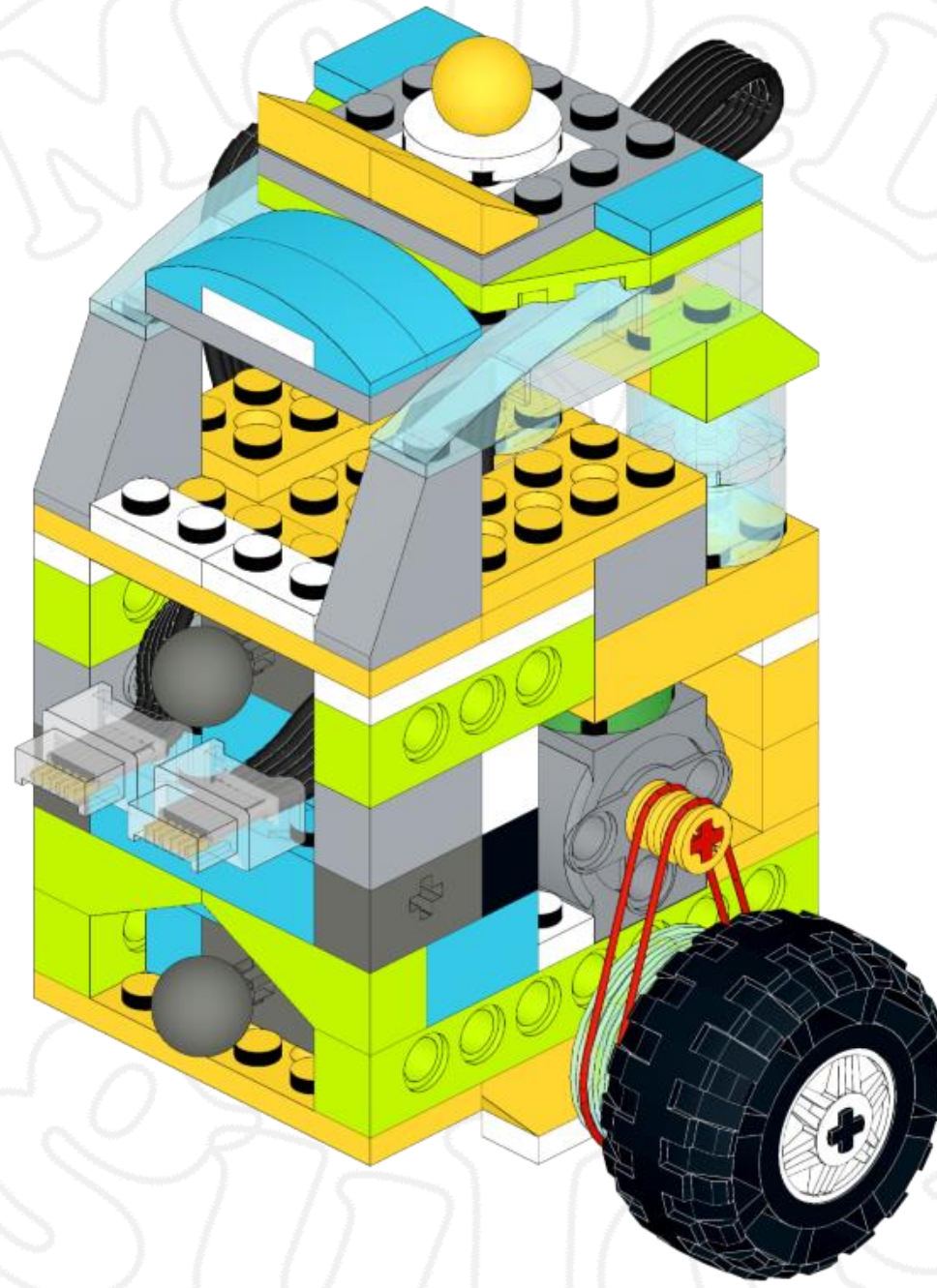
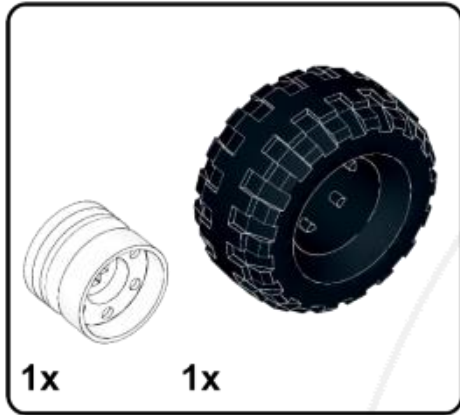

72

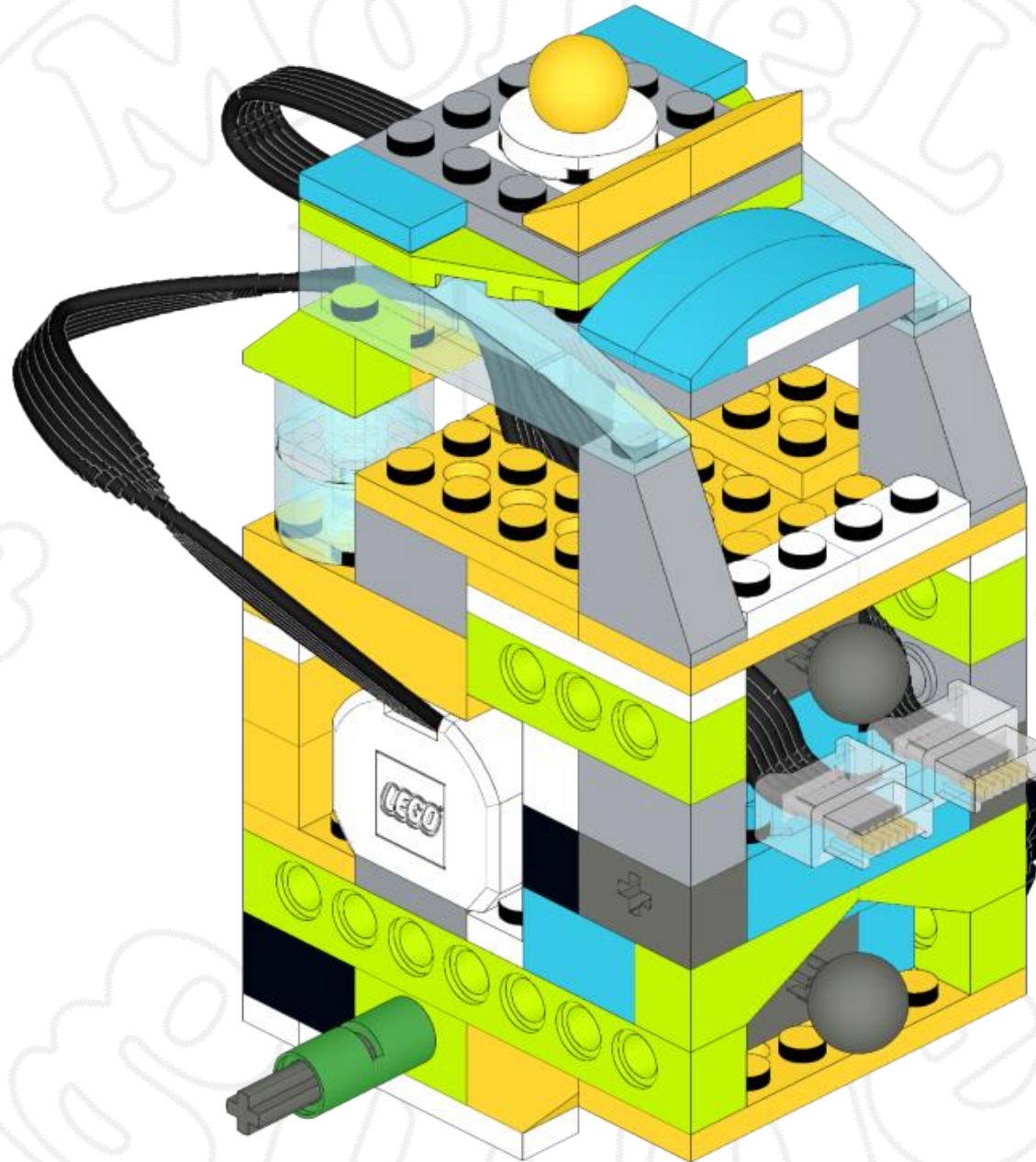
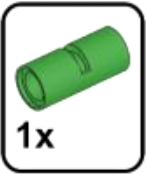

73

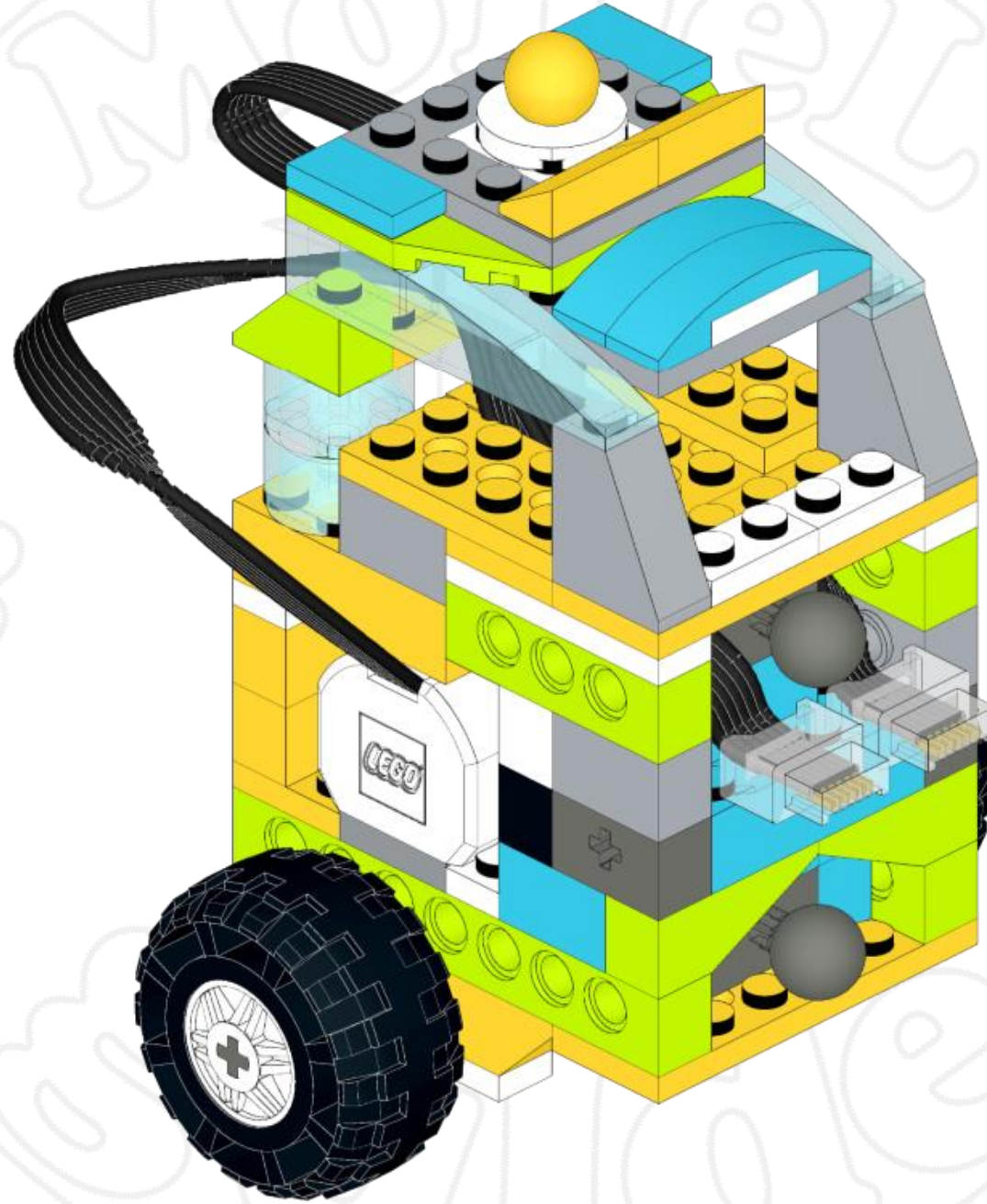
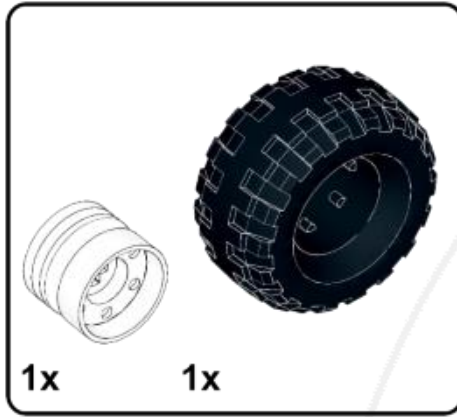

74



75

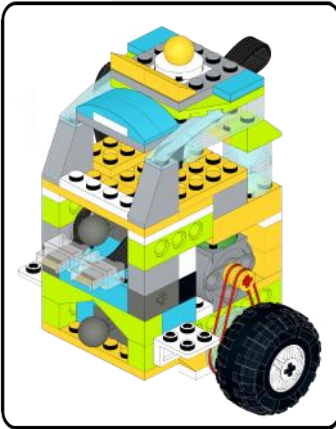

Model

Navigation bar with icons: play, step 6, timer, step 8, undo, step 8, timer, step 9, delete, refresh.

6



8



8



9

Guide

