

# WEDO 2.0

## ВЕЛОКОТ

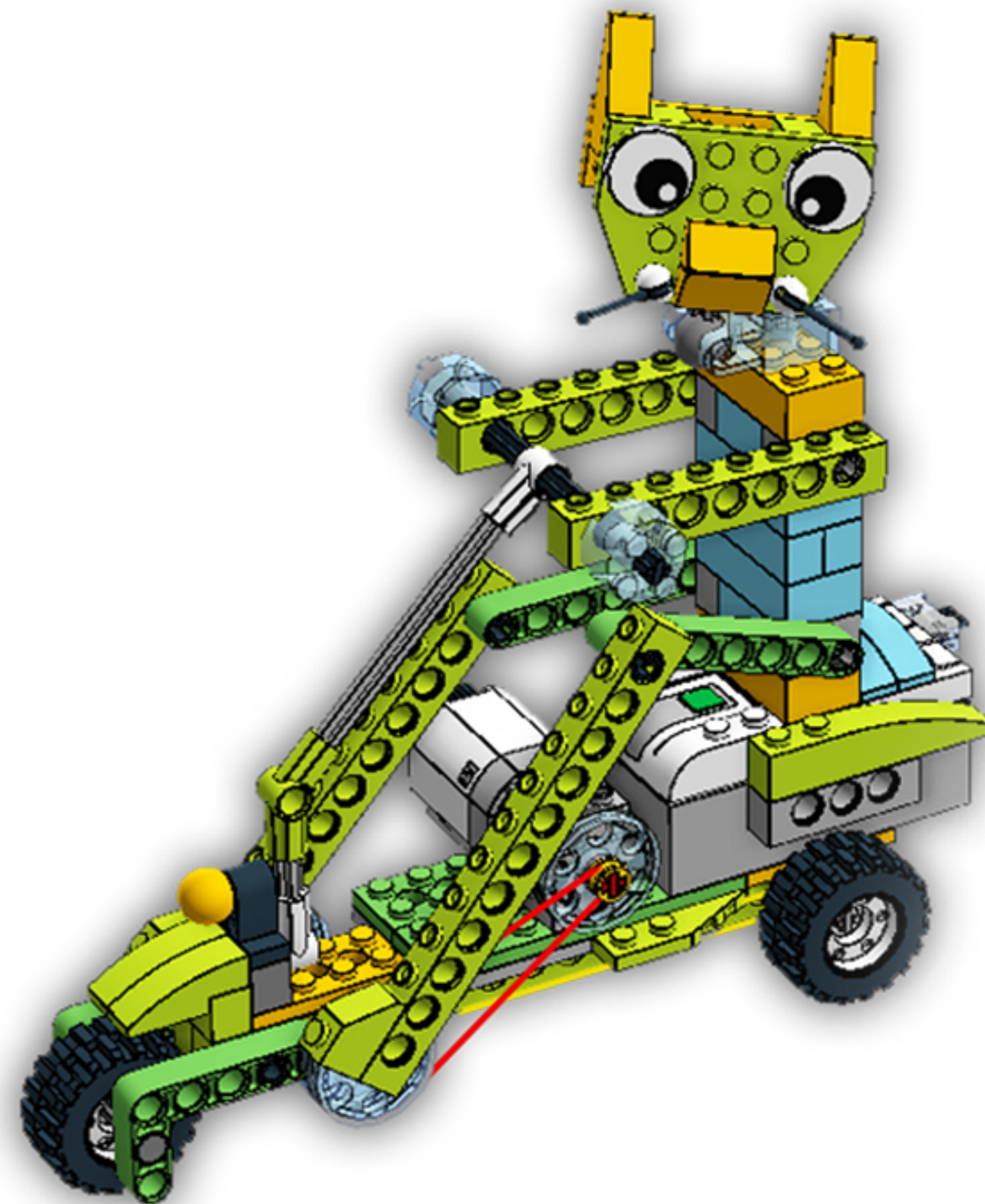

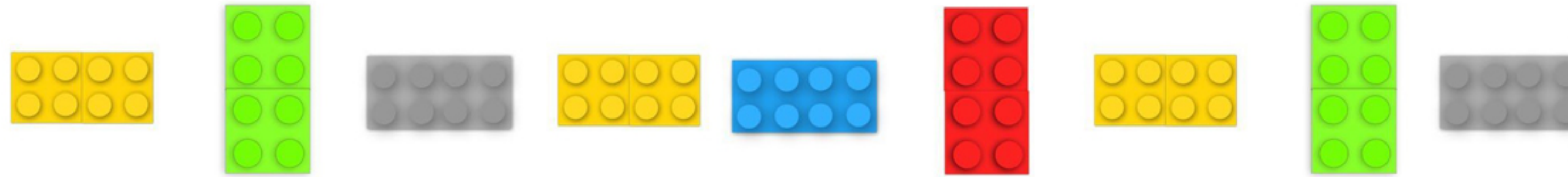
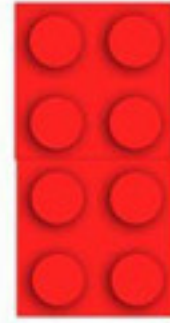
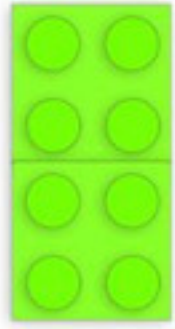
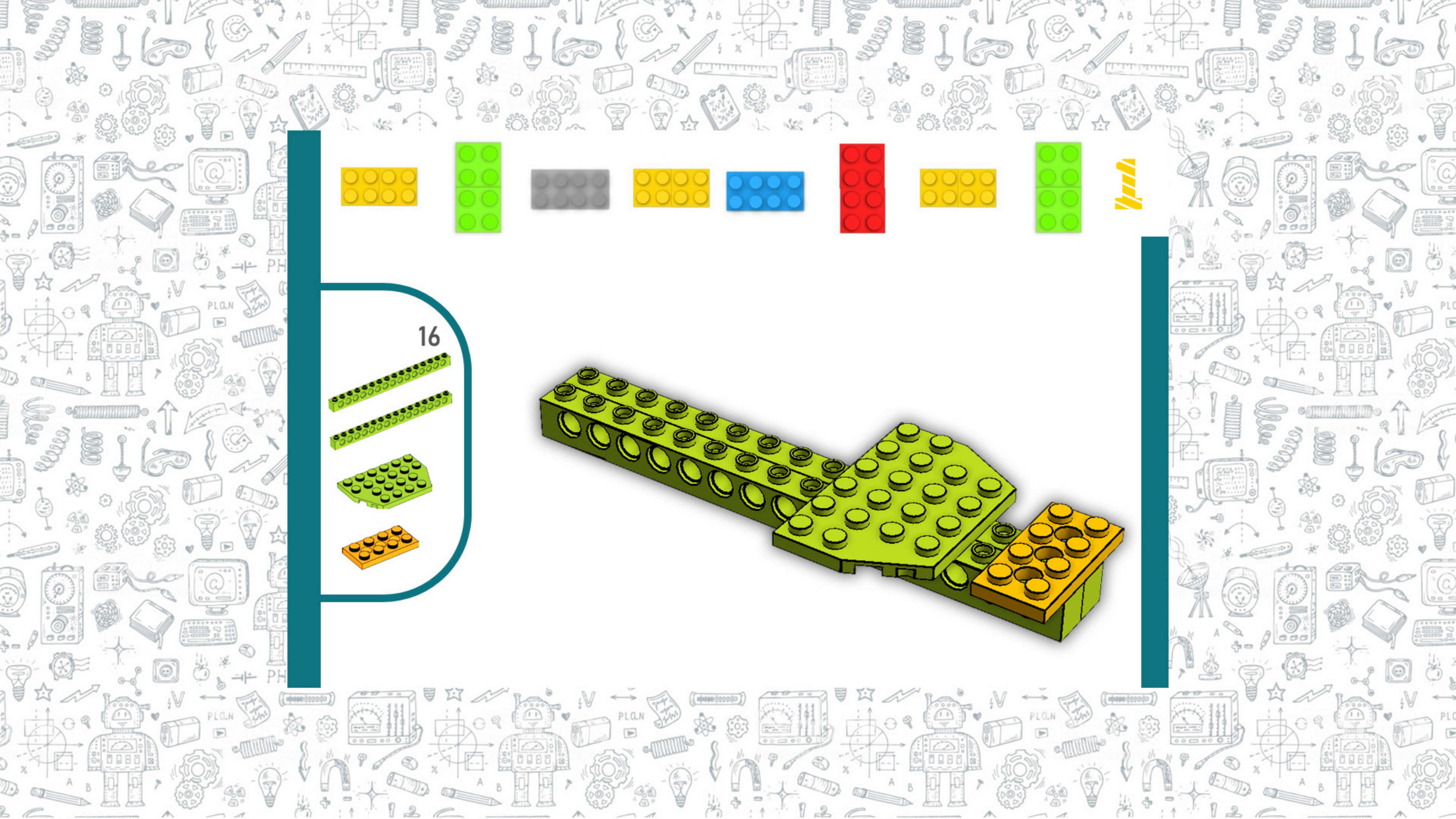

16

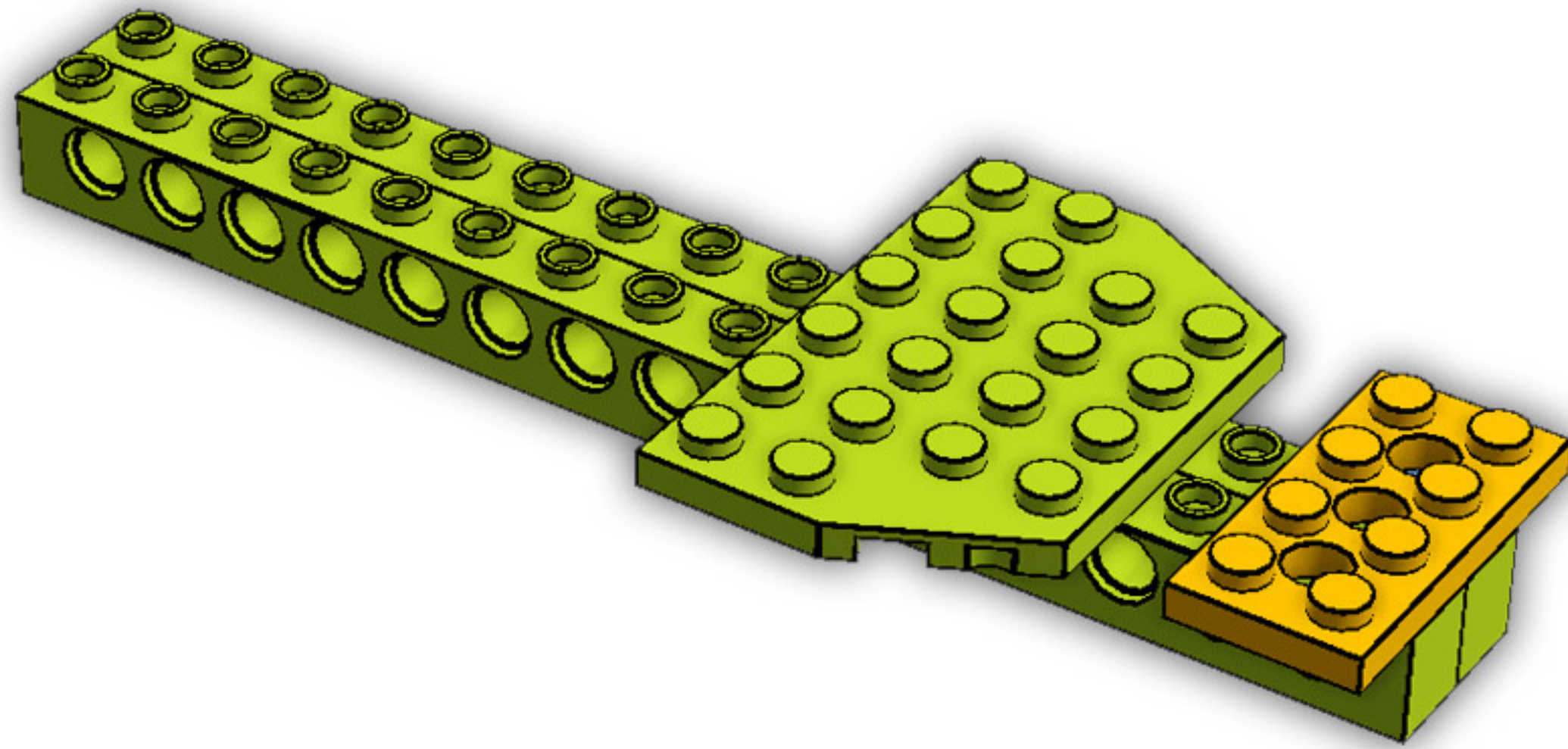
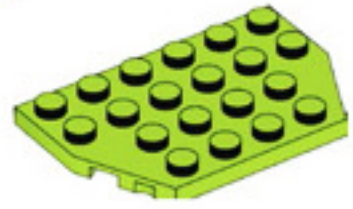

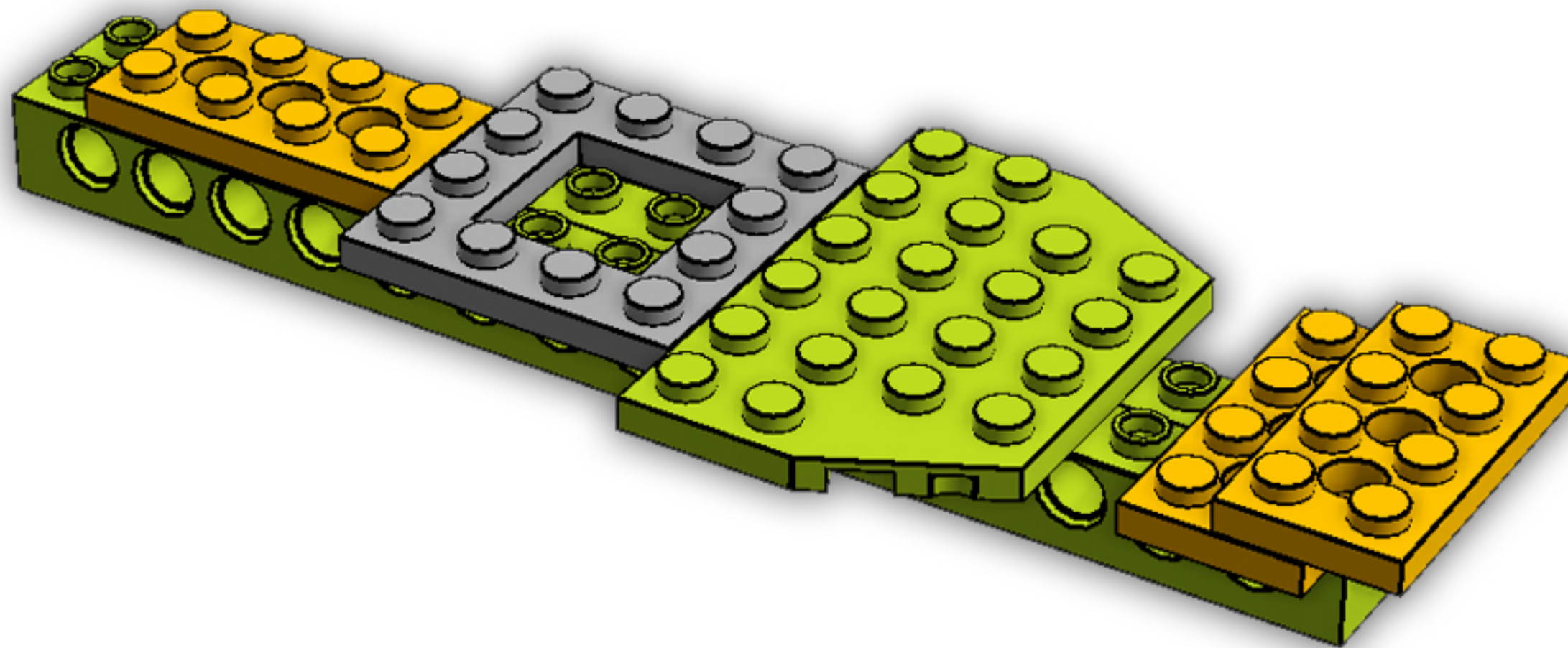
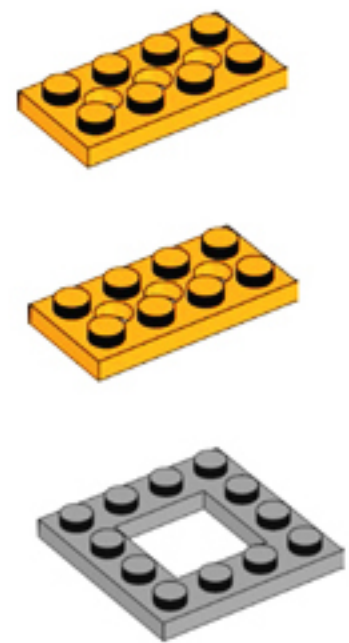
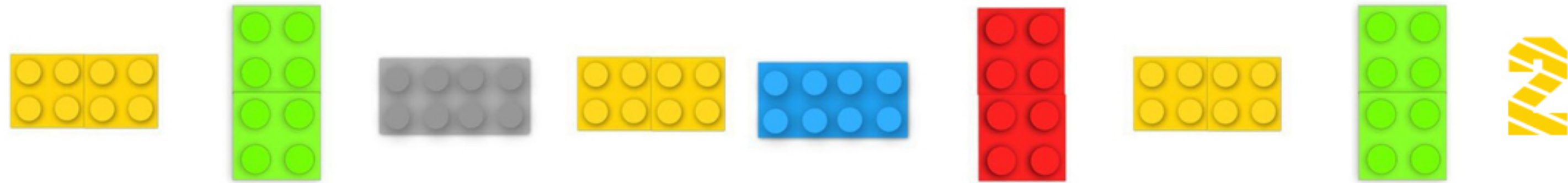
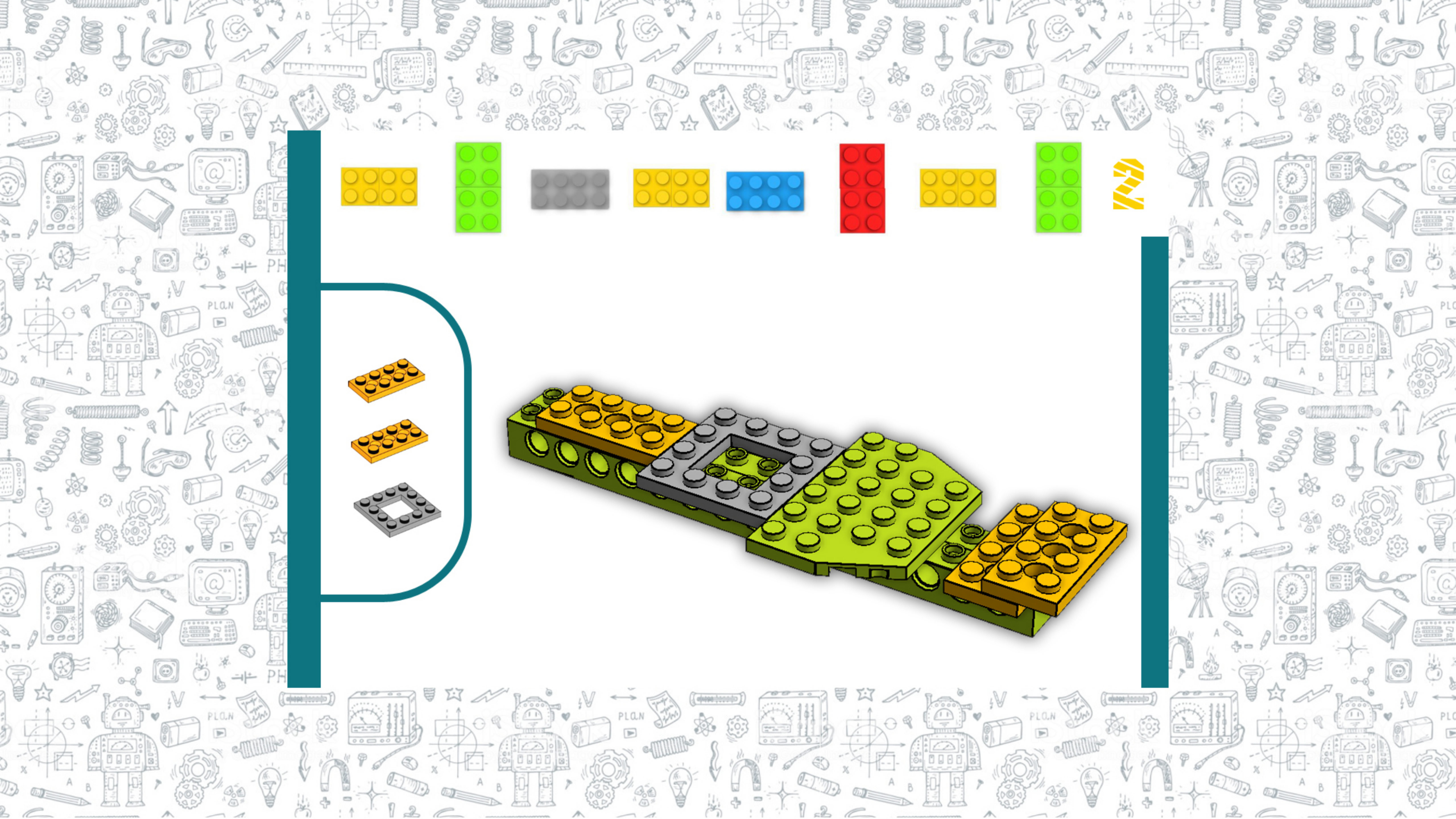

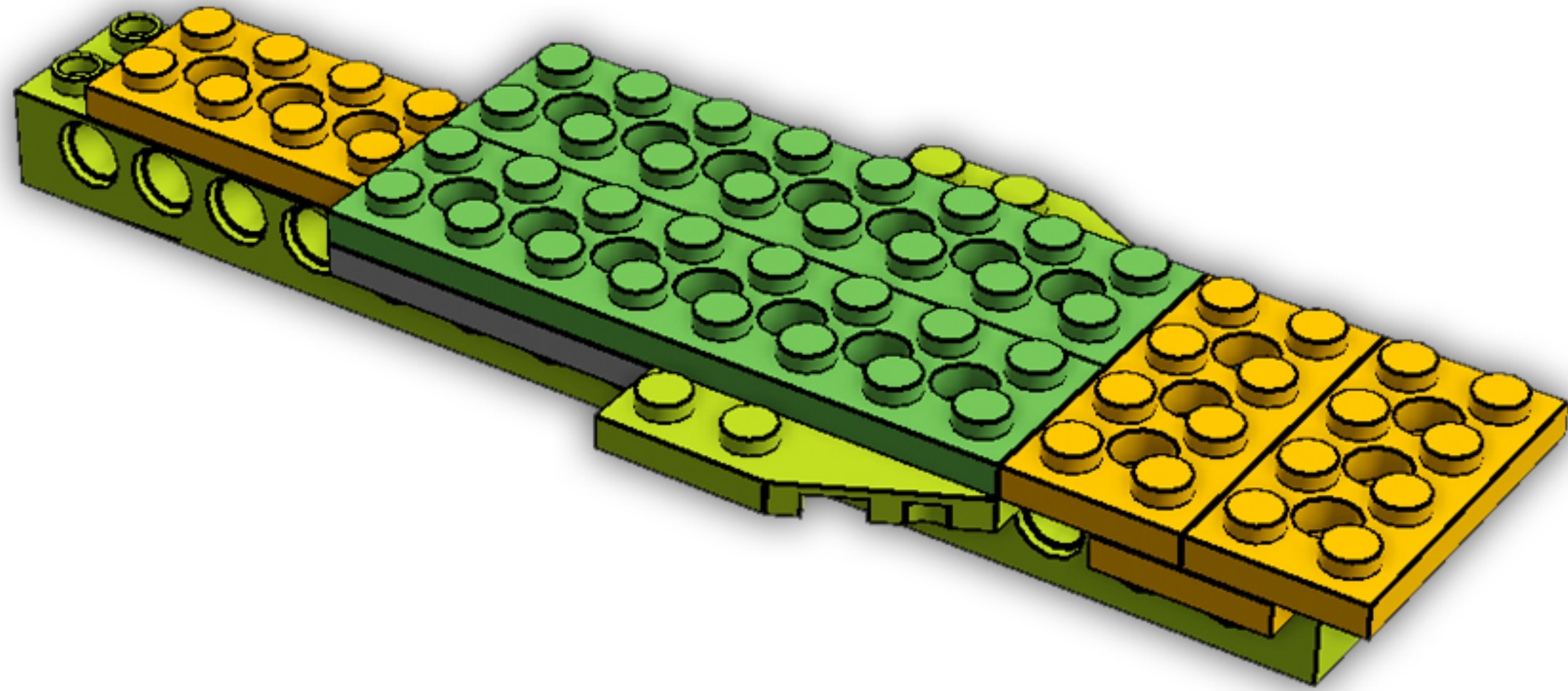
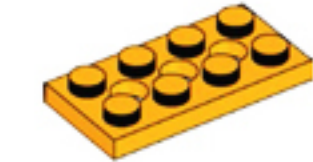
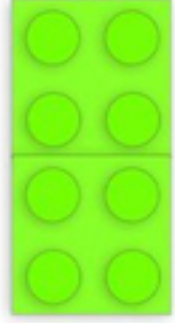
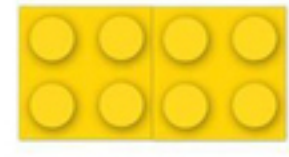

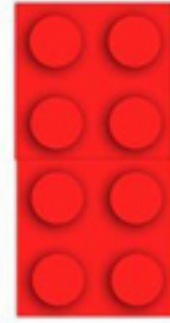
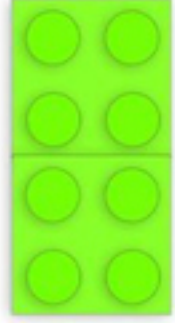
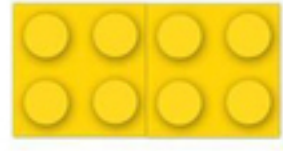

7

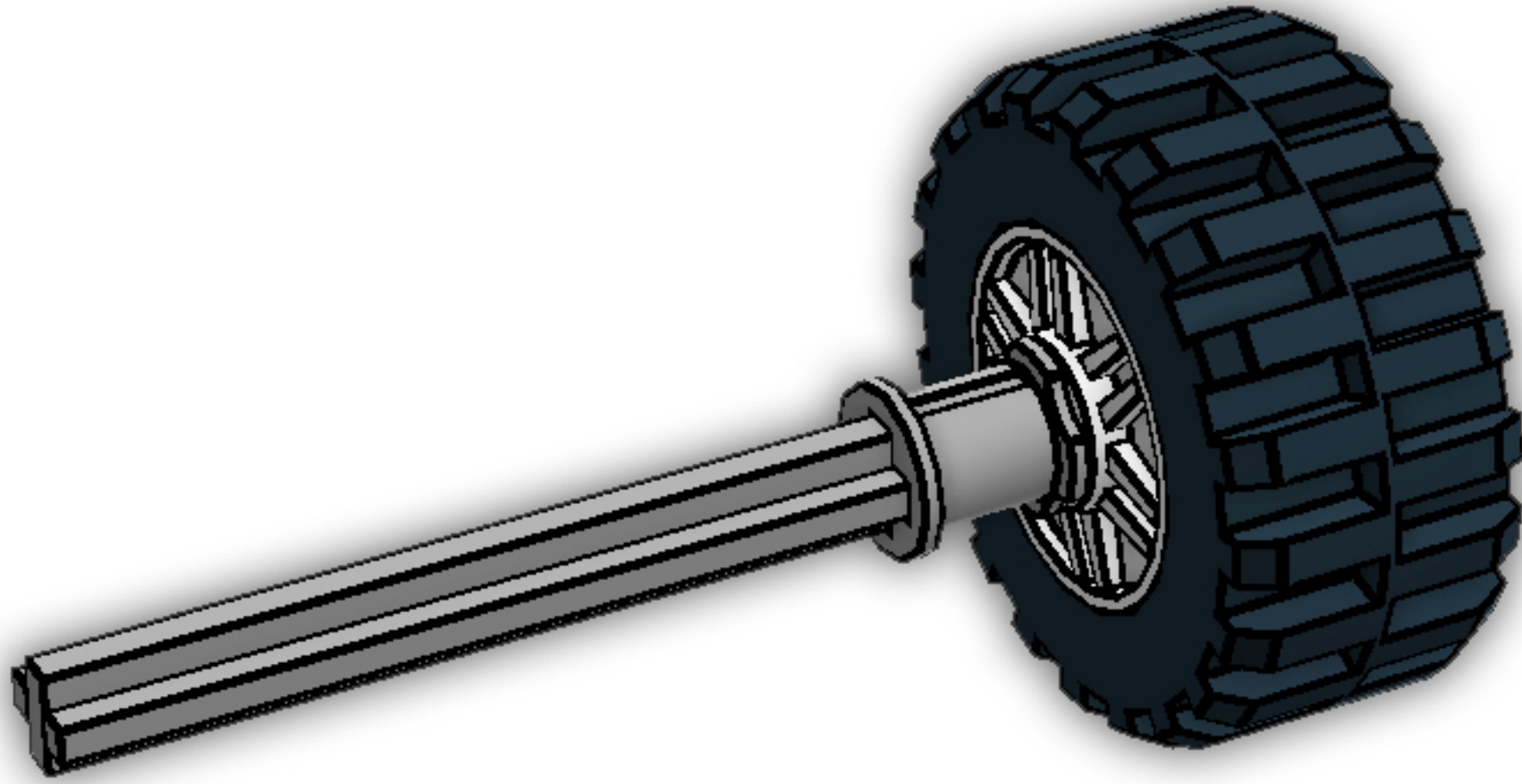

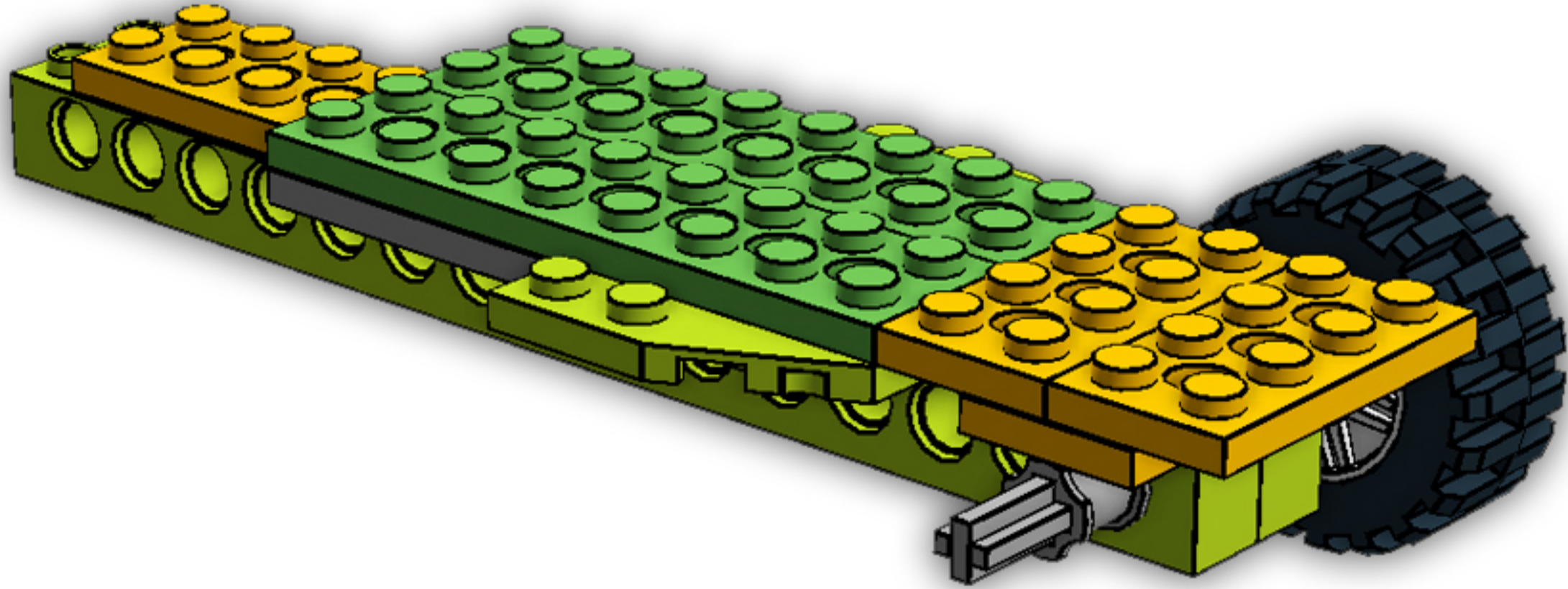
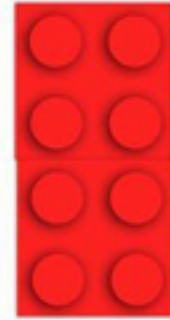
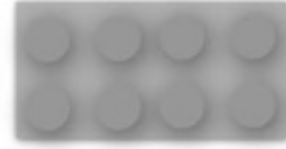
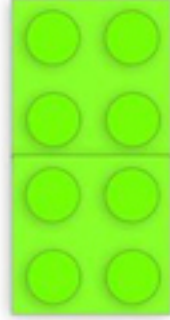
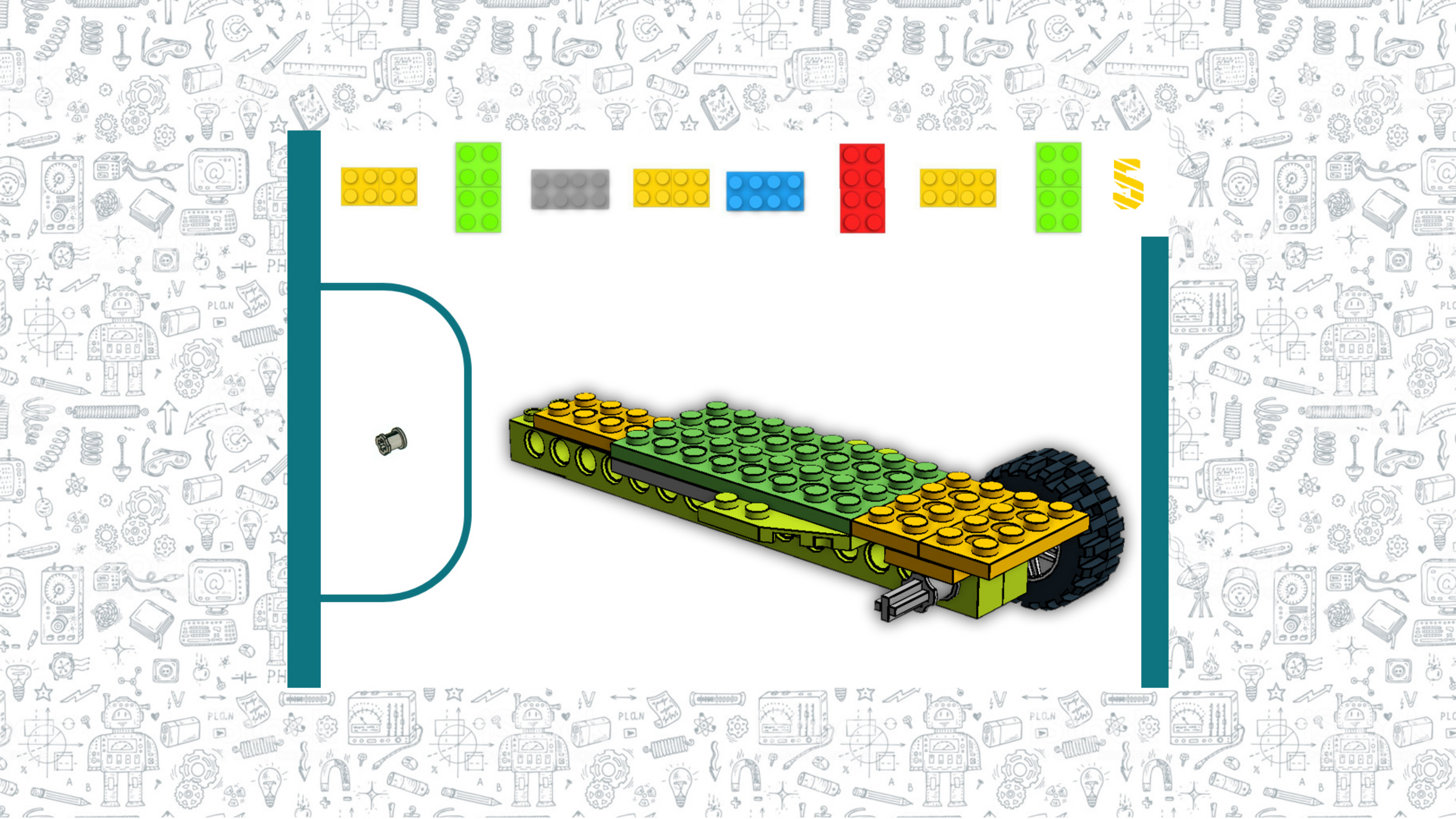

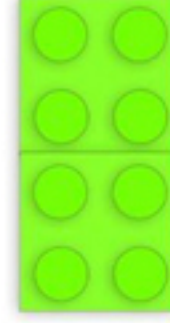
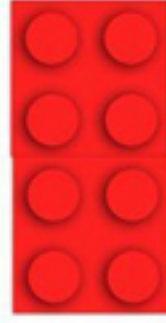
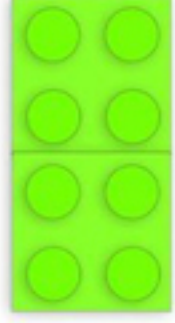

6

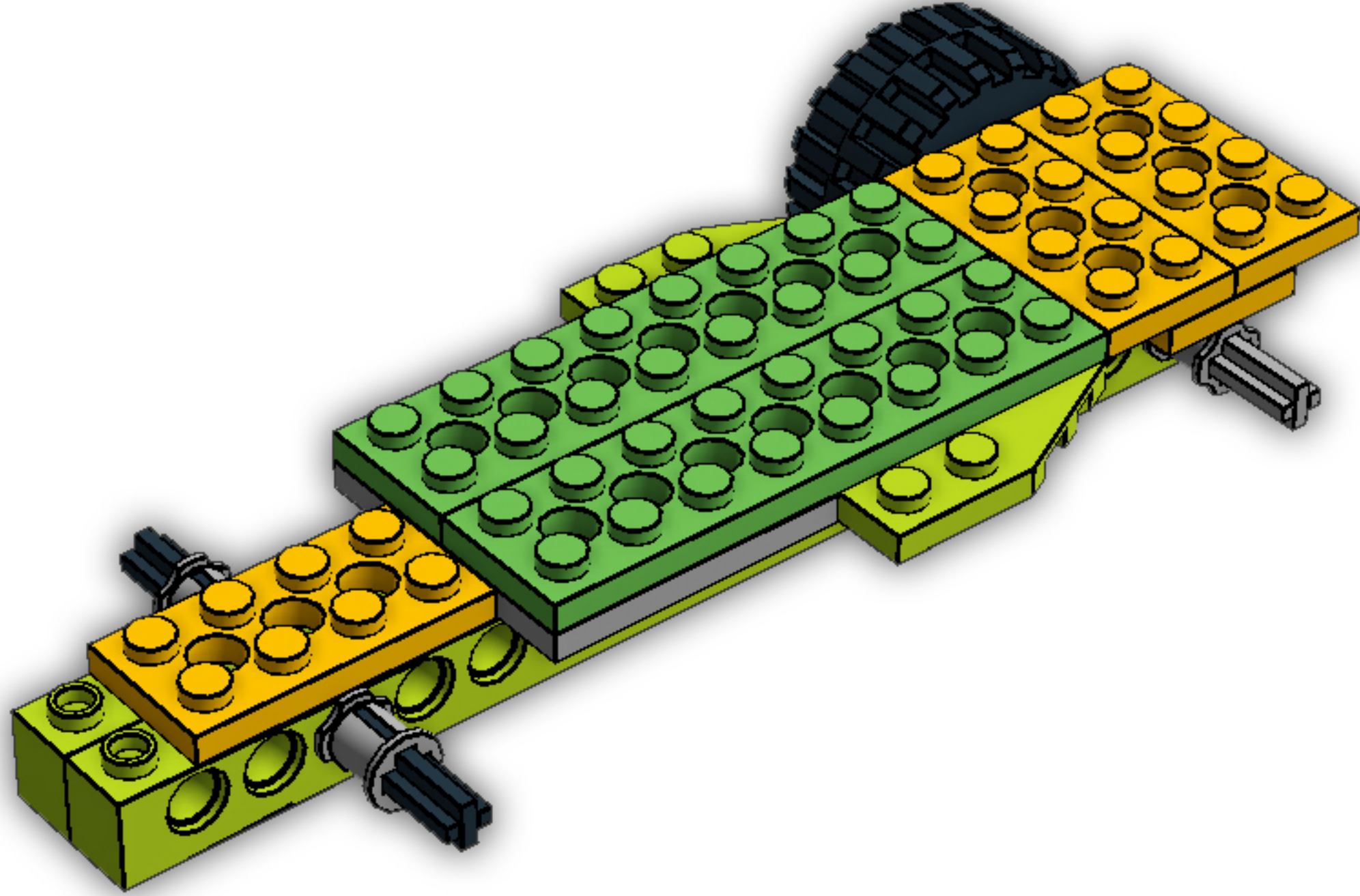

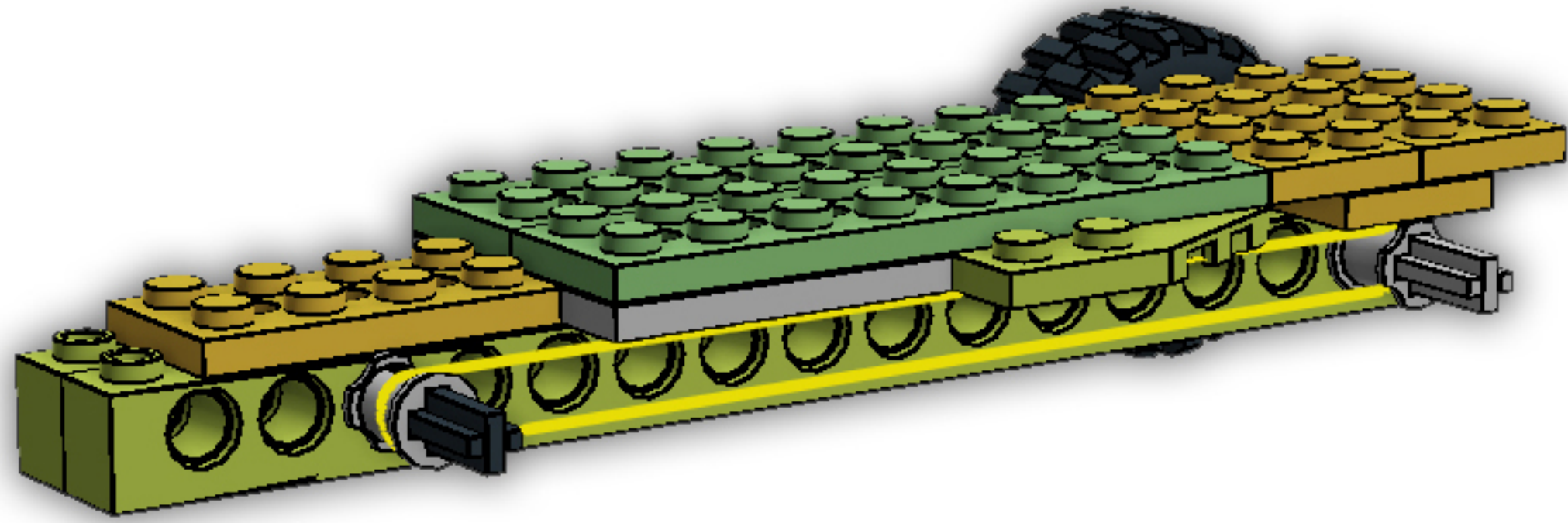
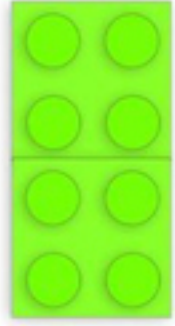
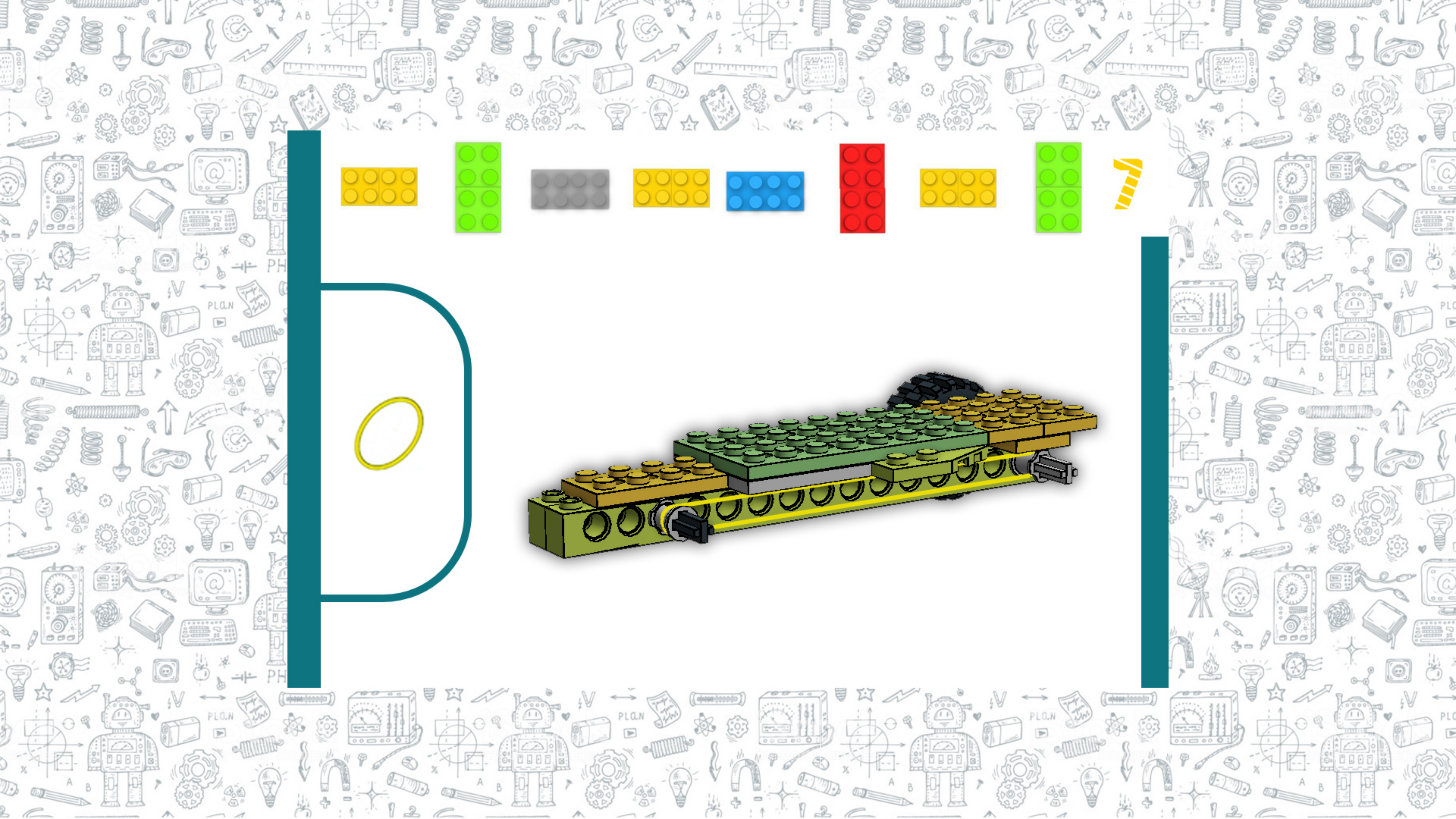



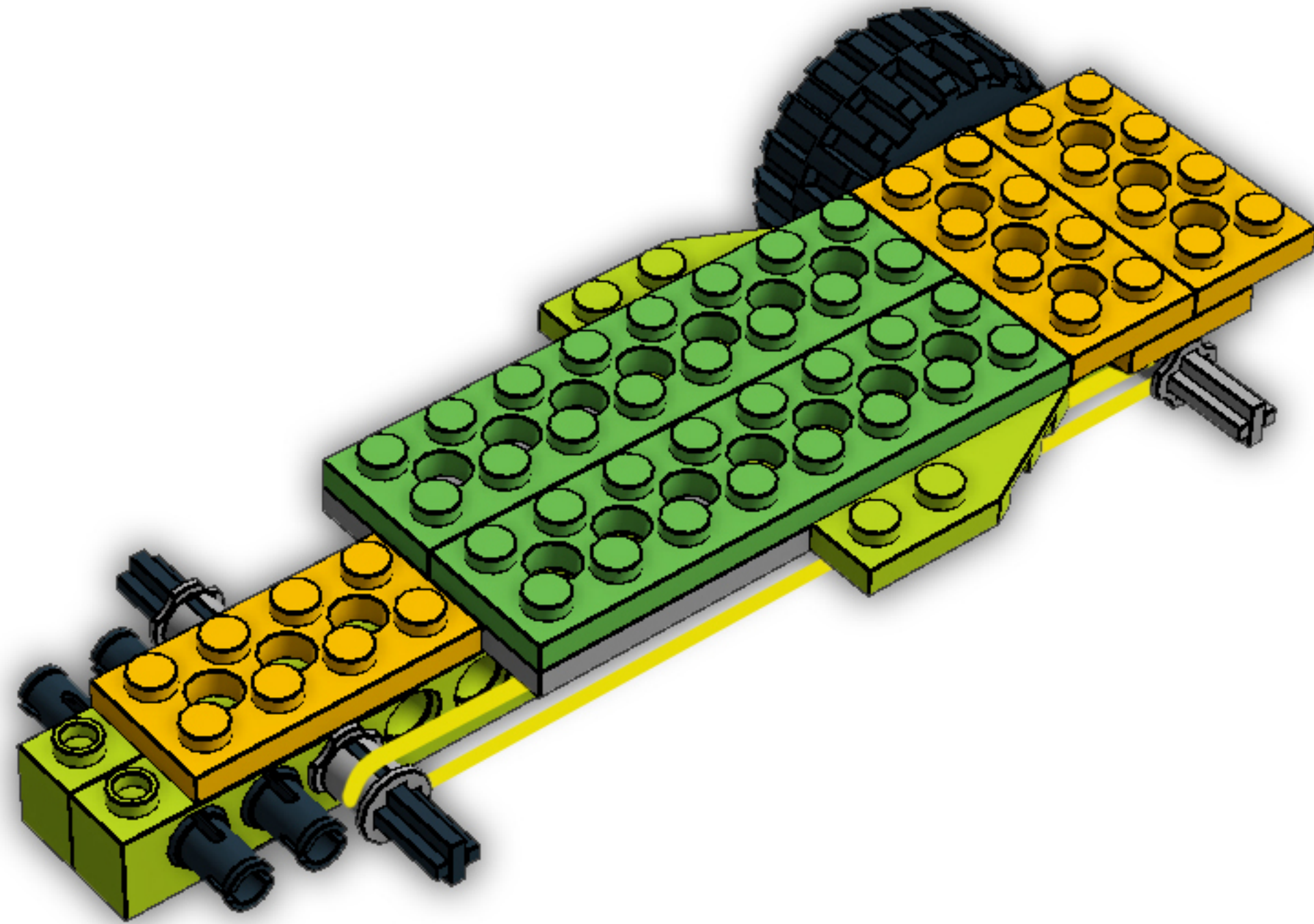
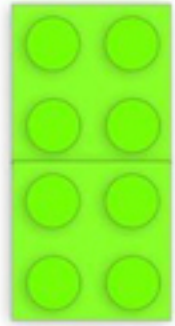
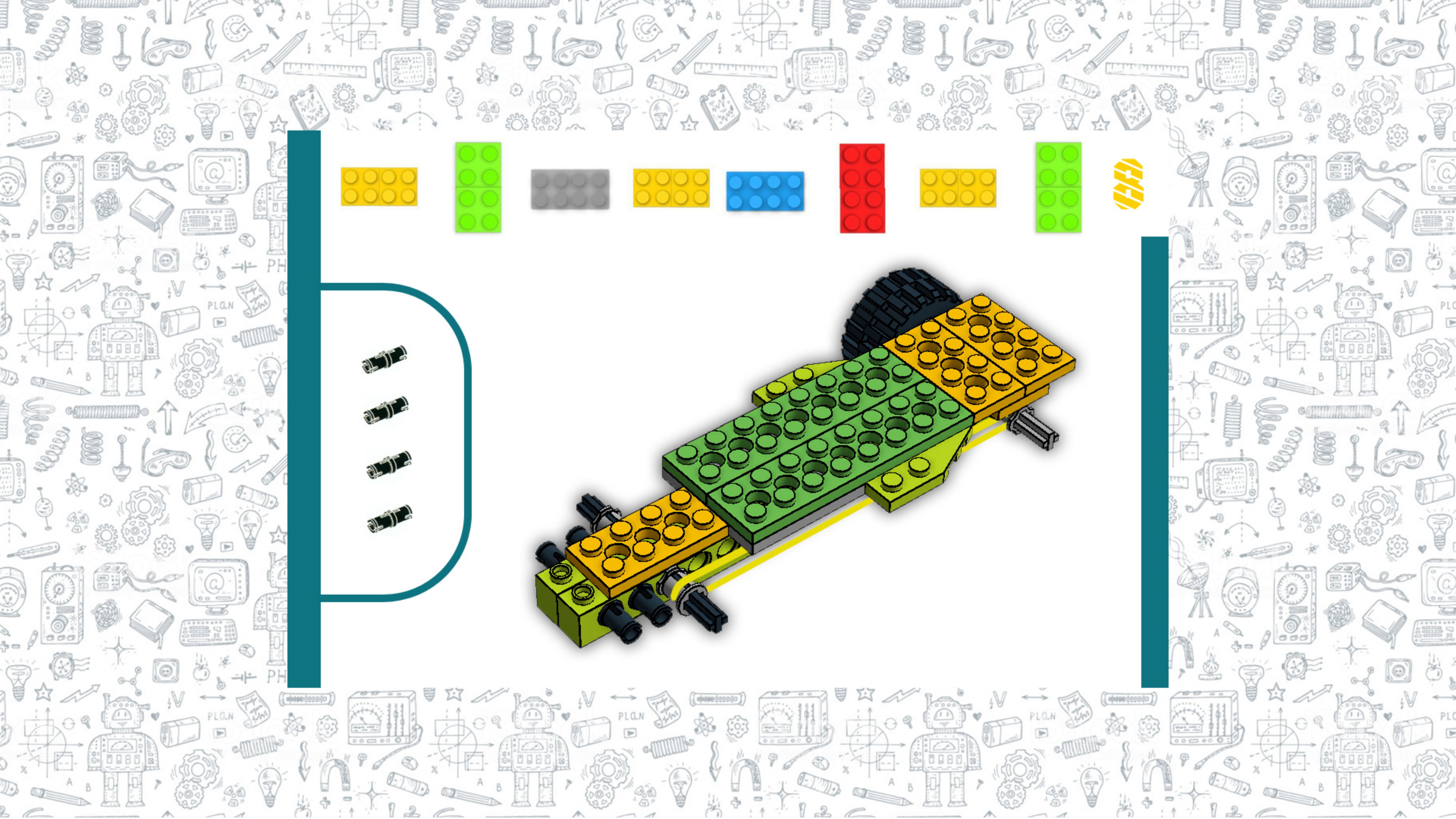

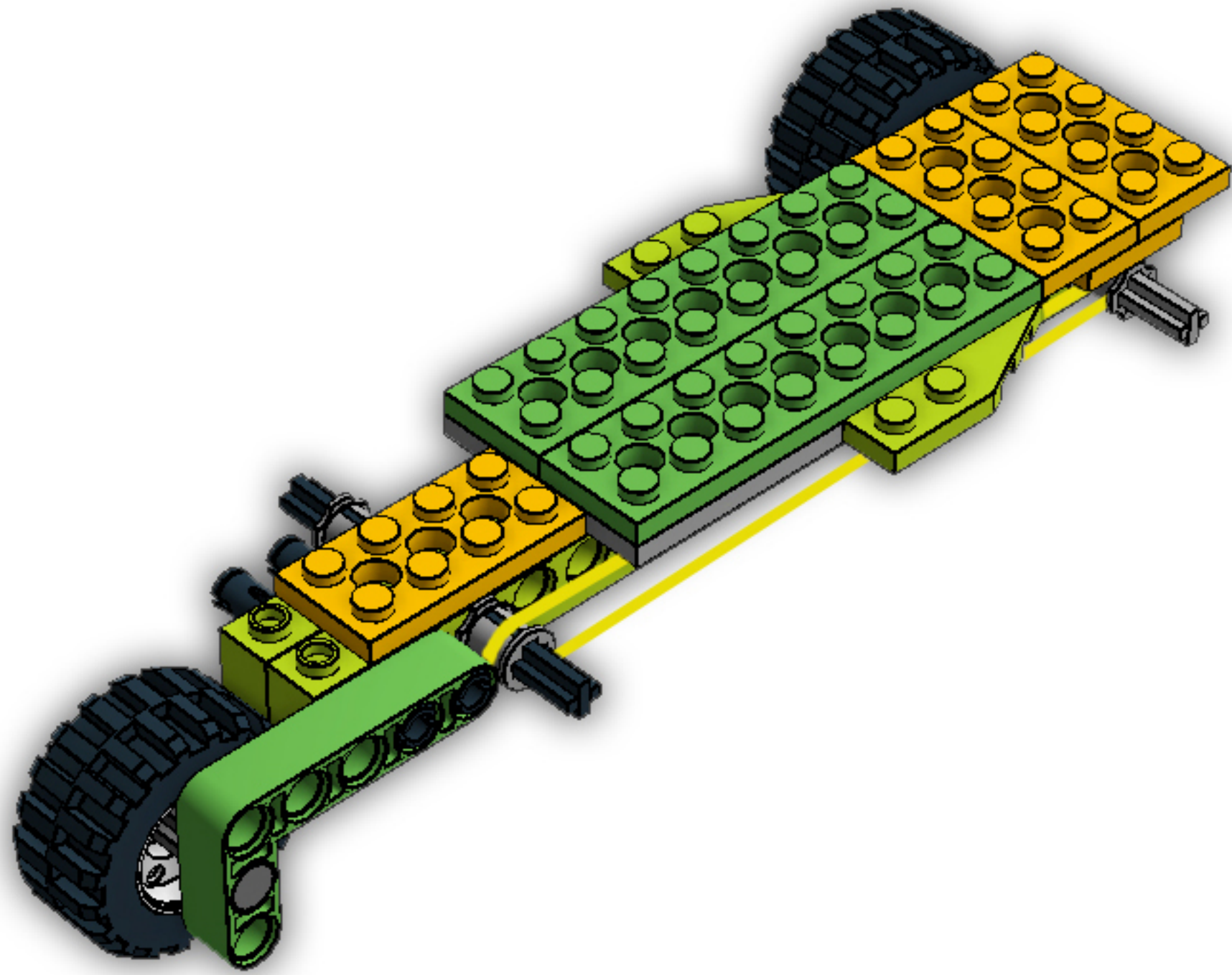
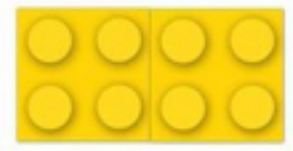
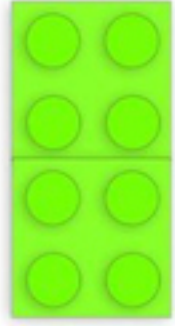

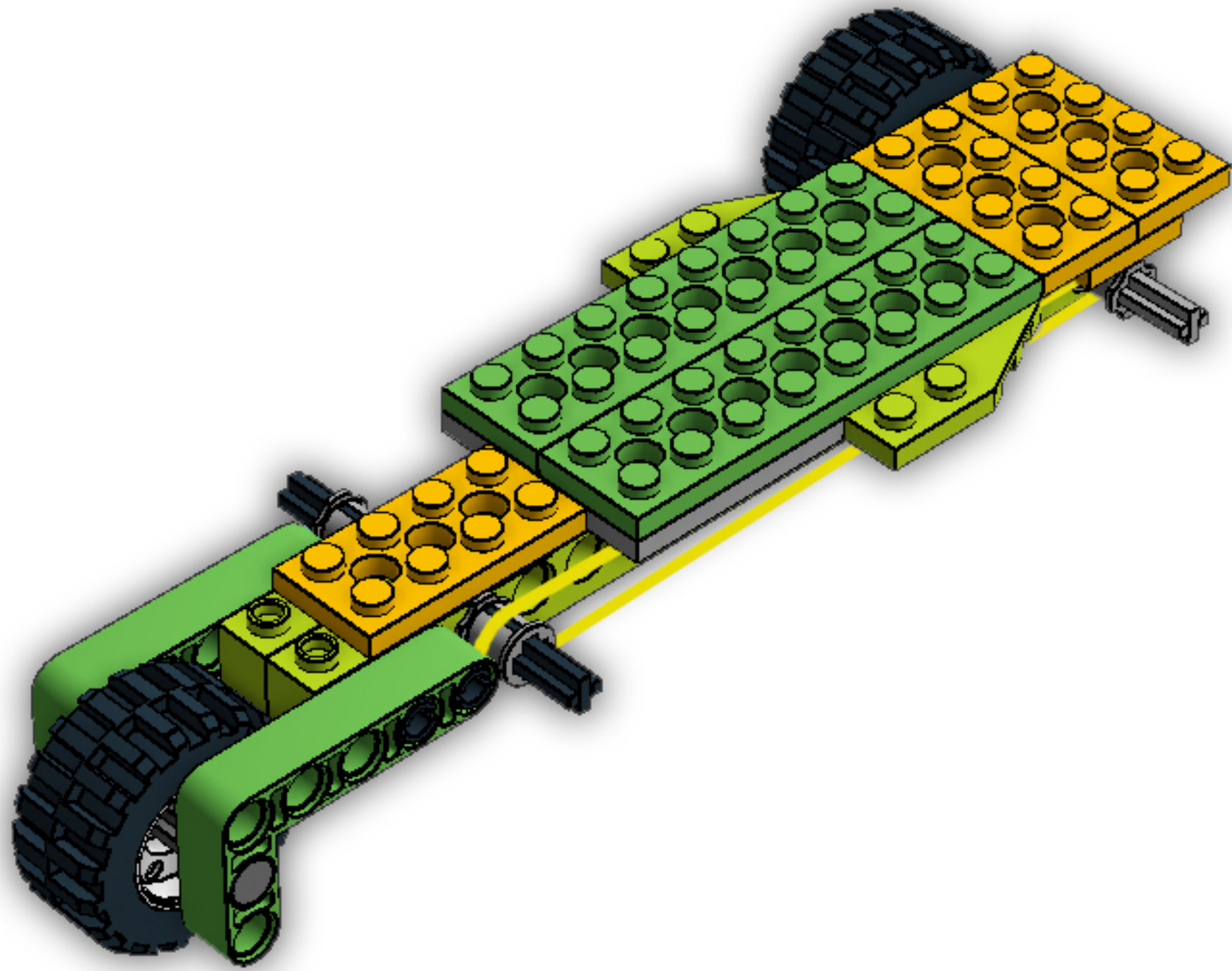
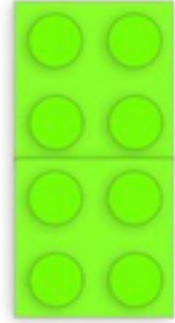
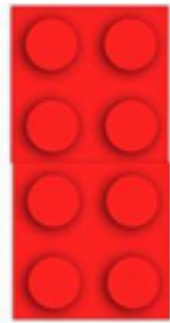
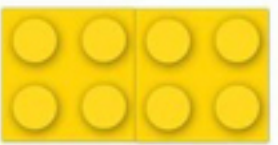
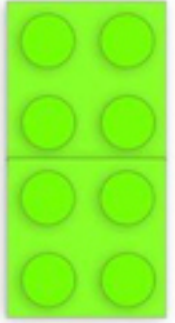

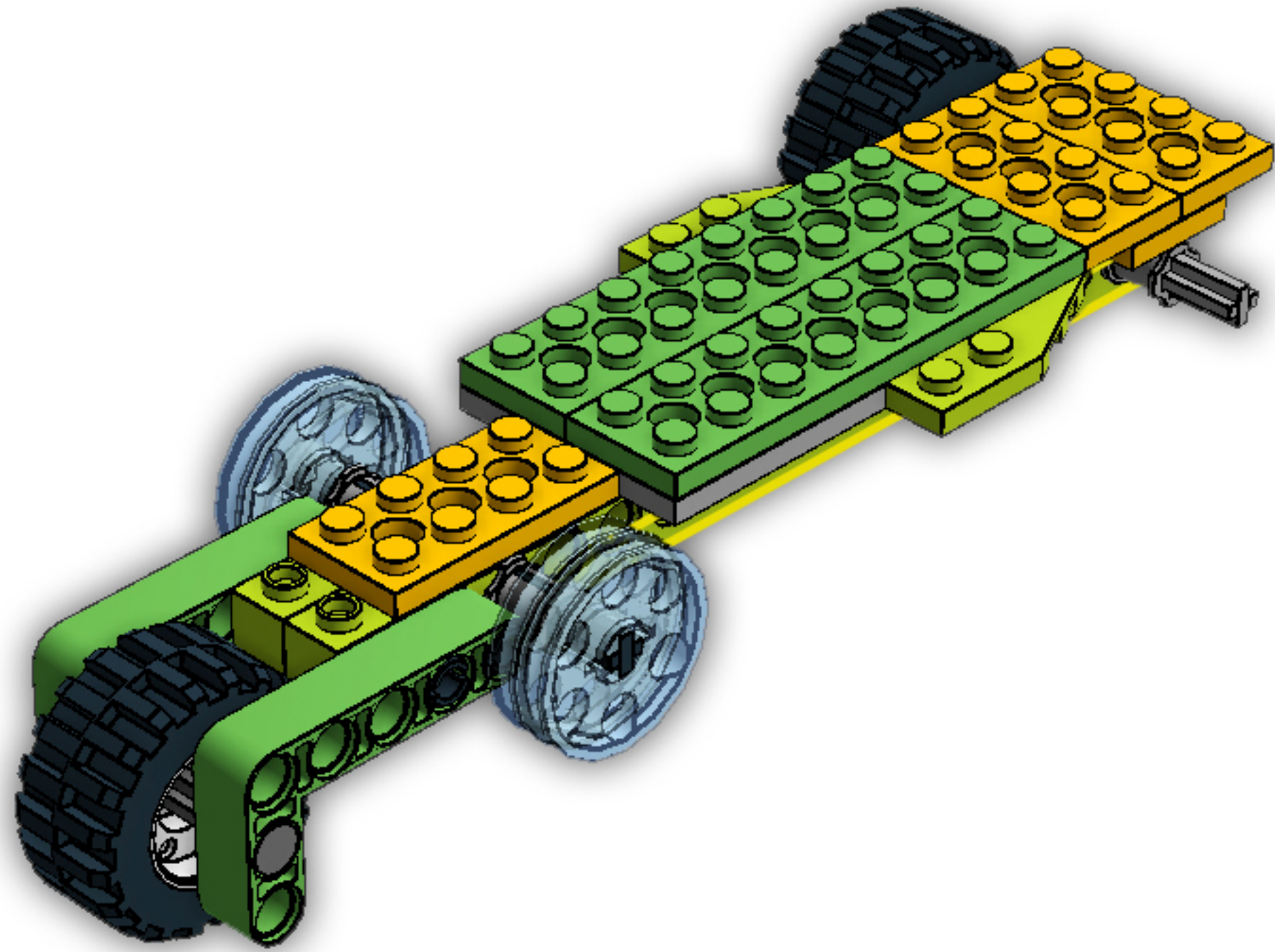
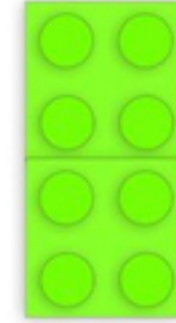
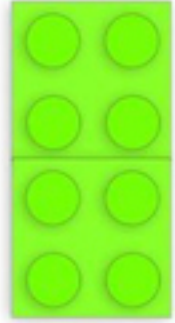
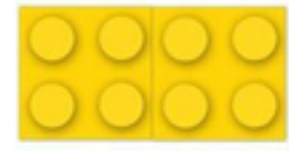
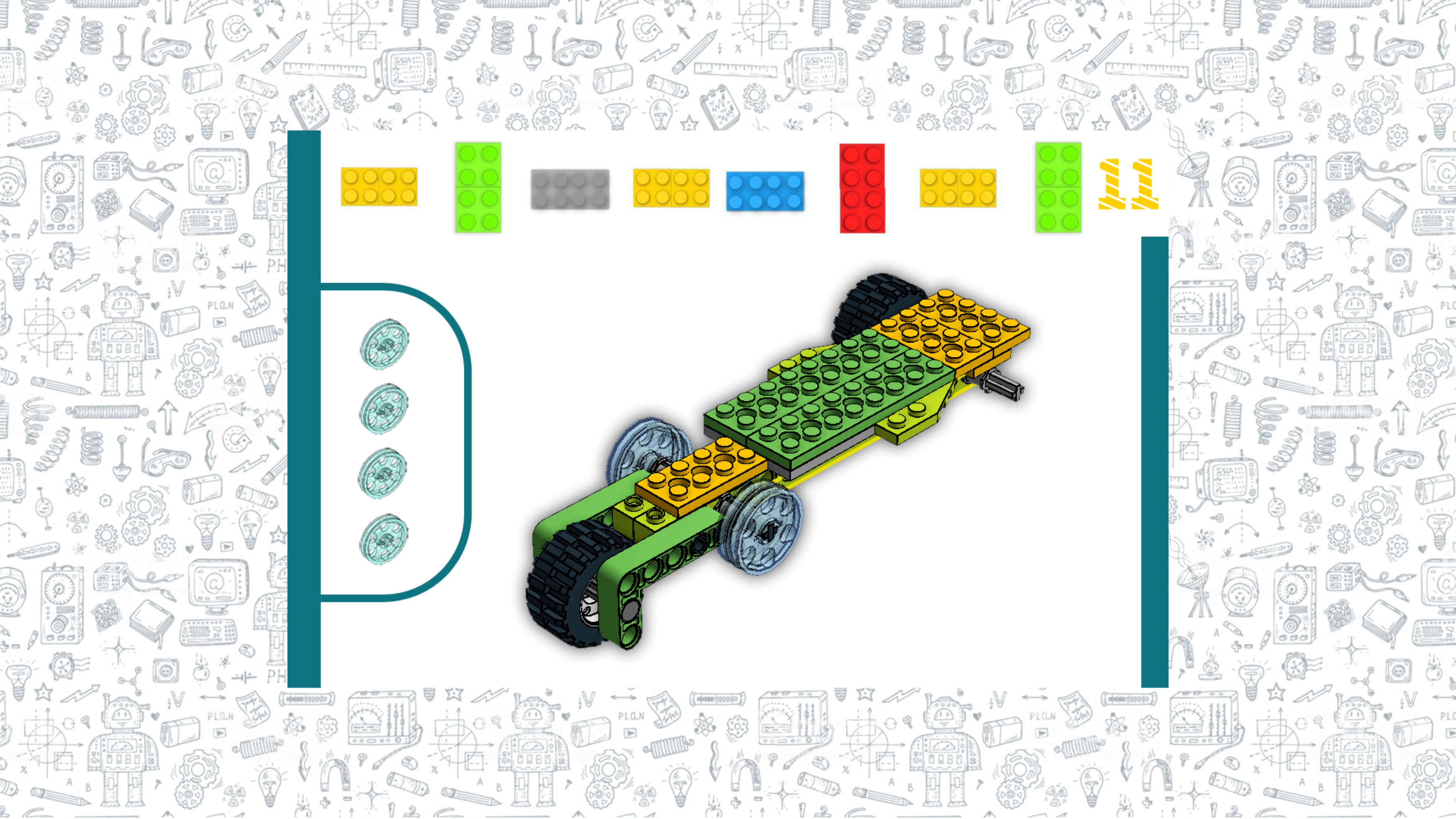



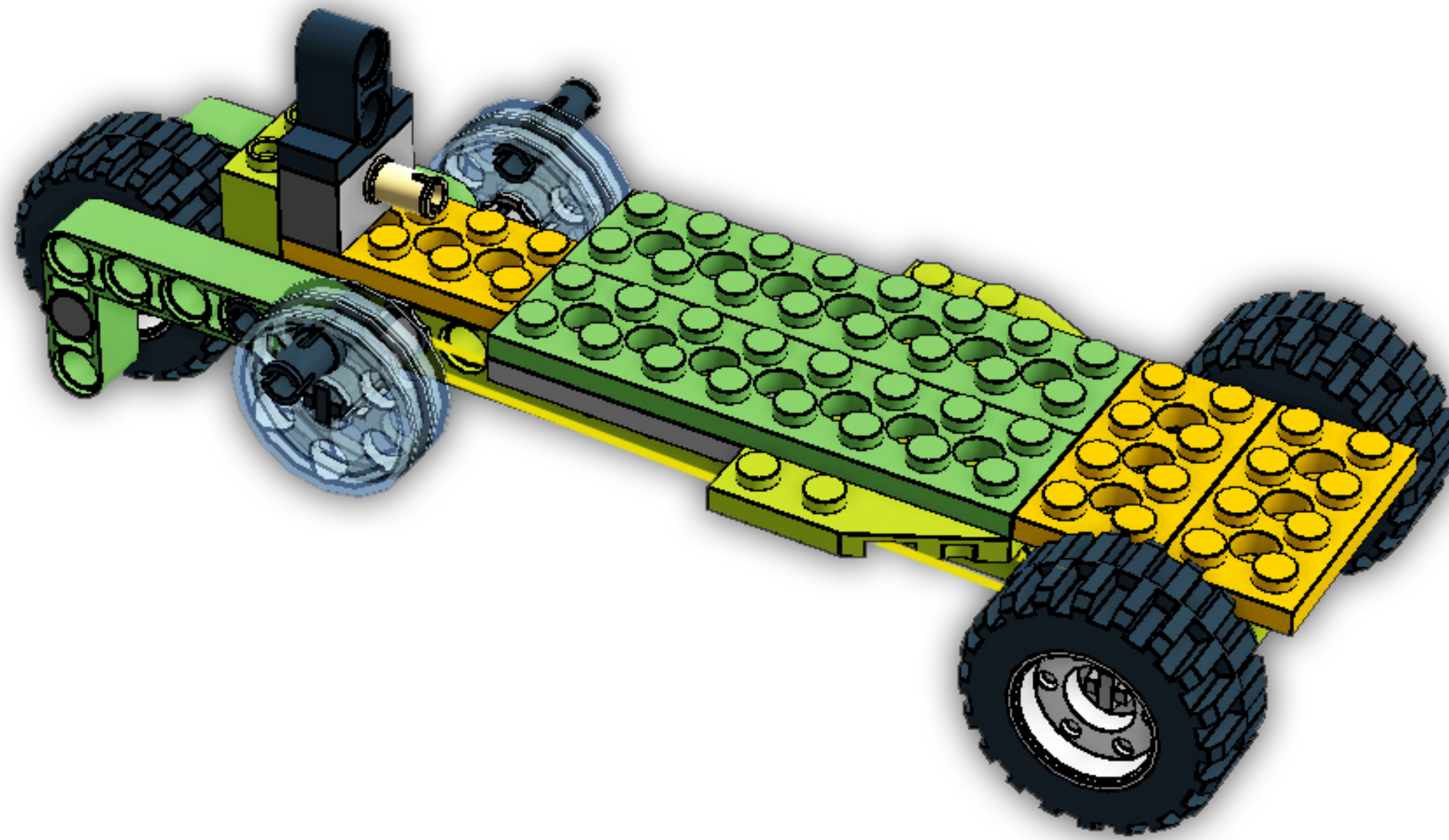
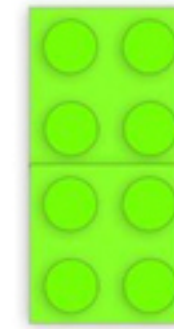
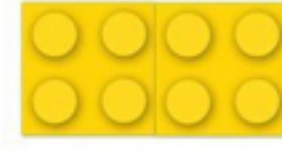
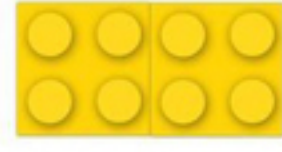
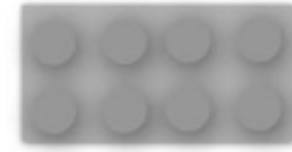
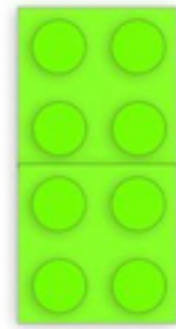

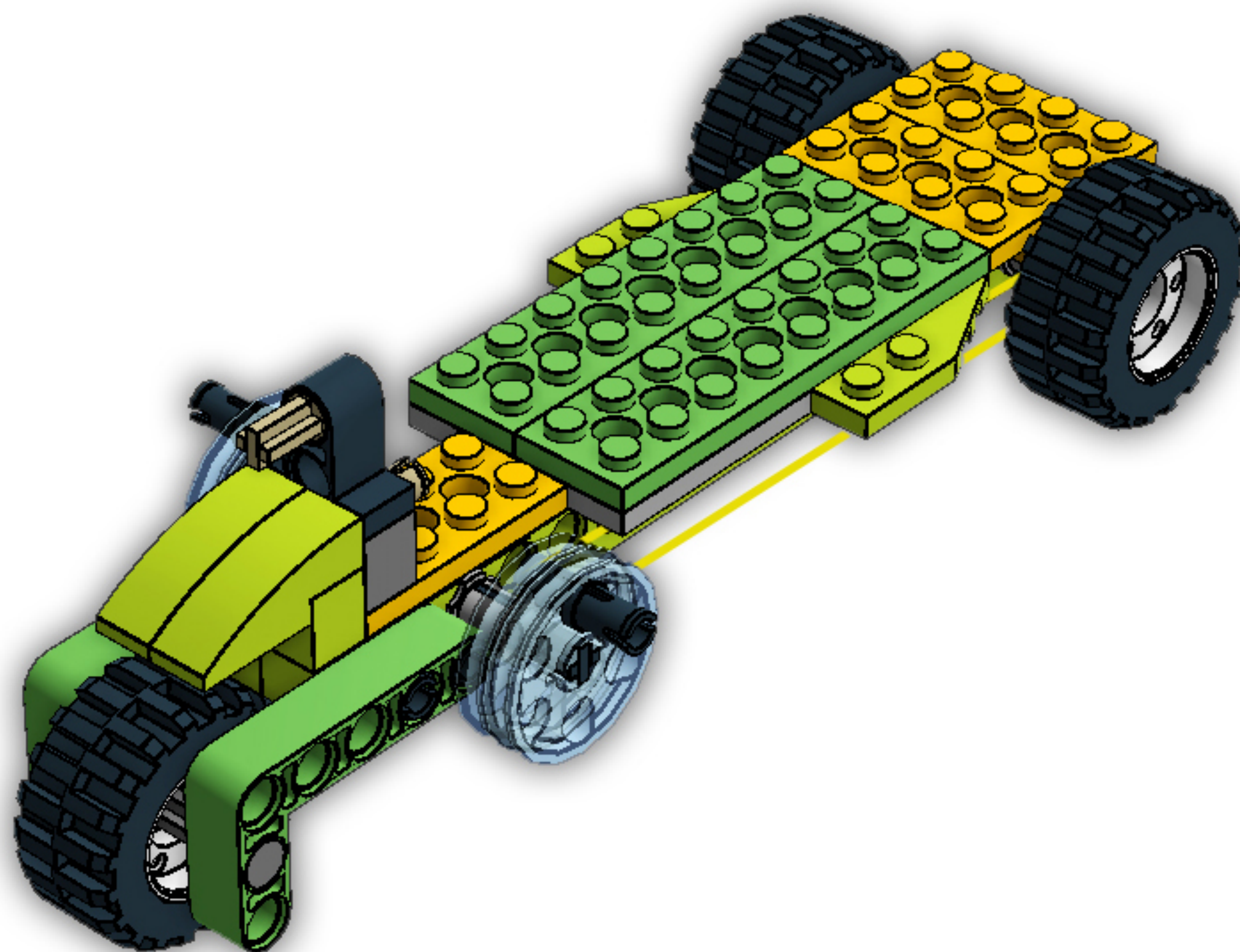
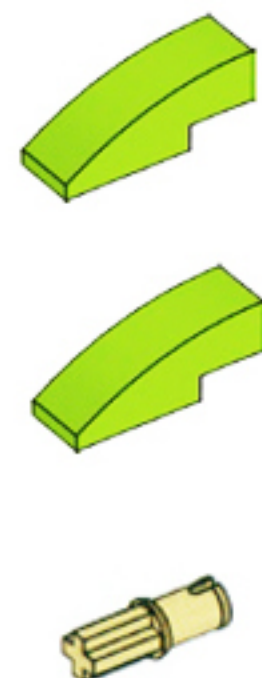
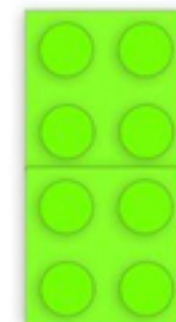
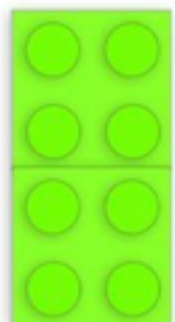

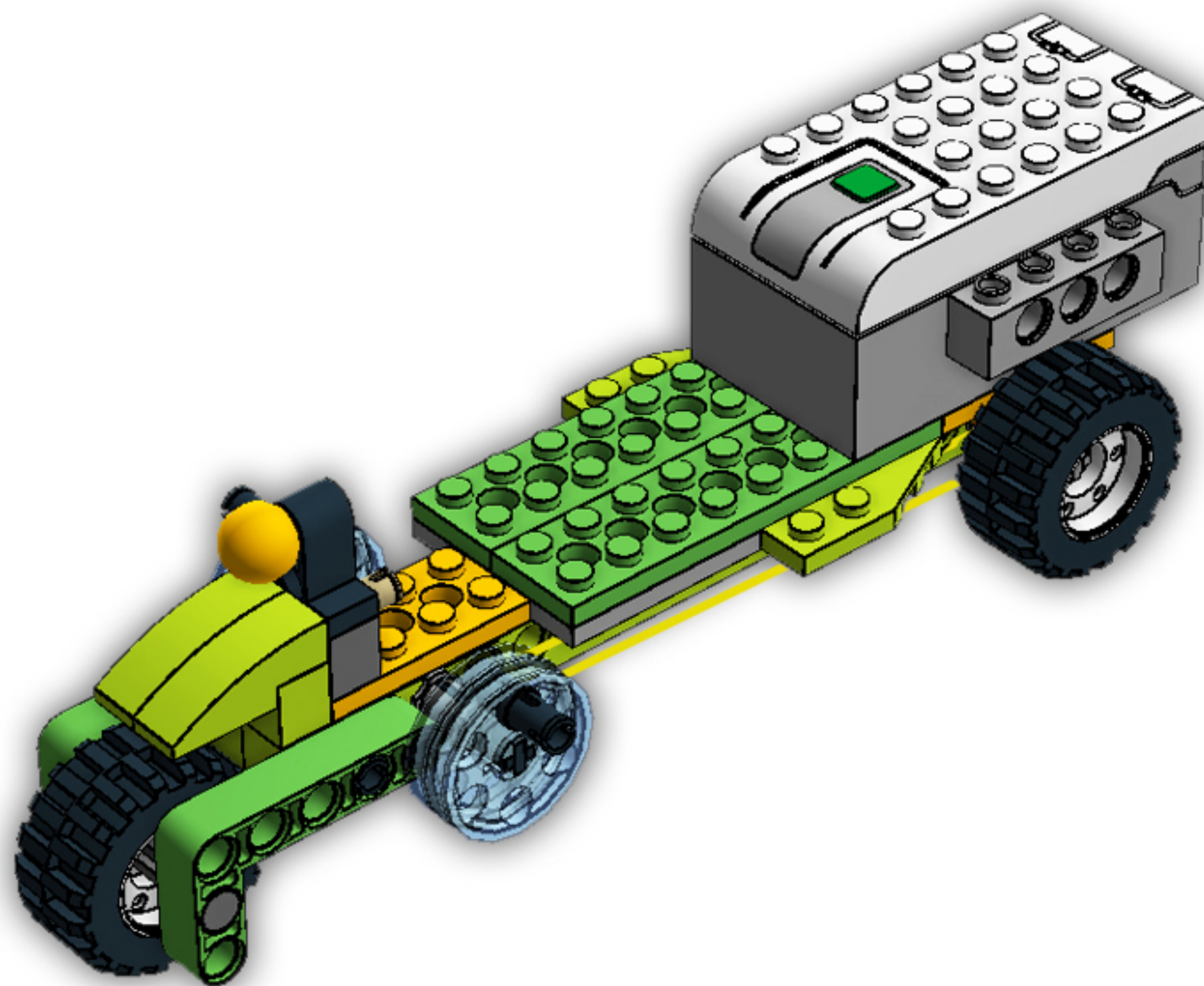
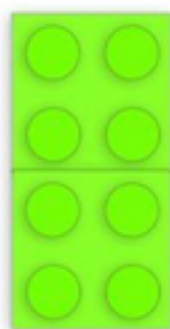
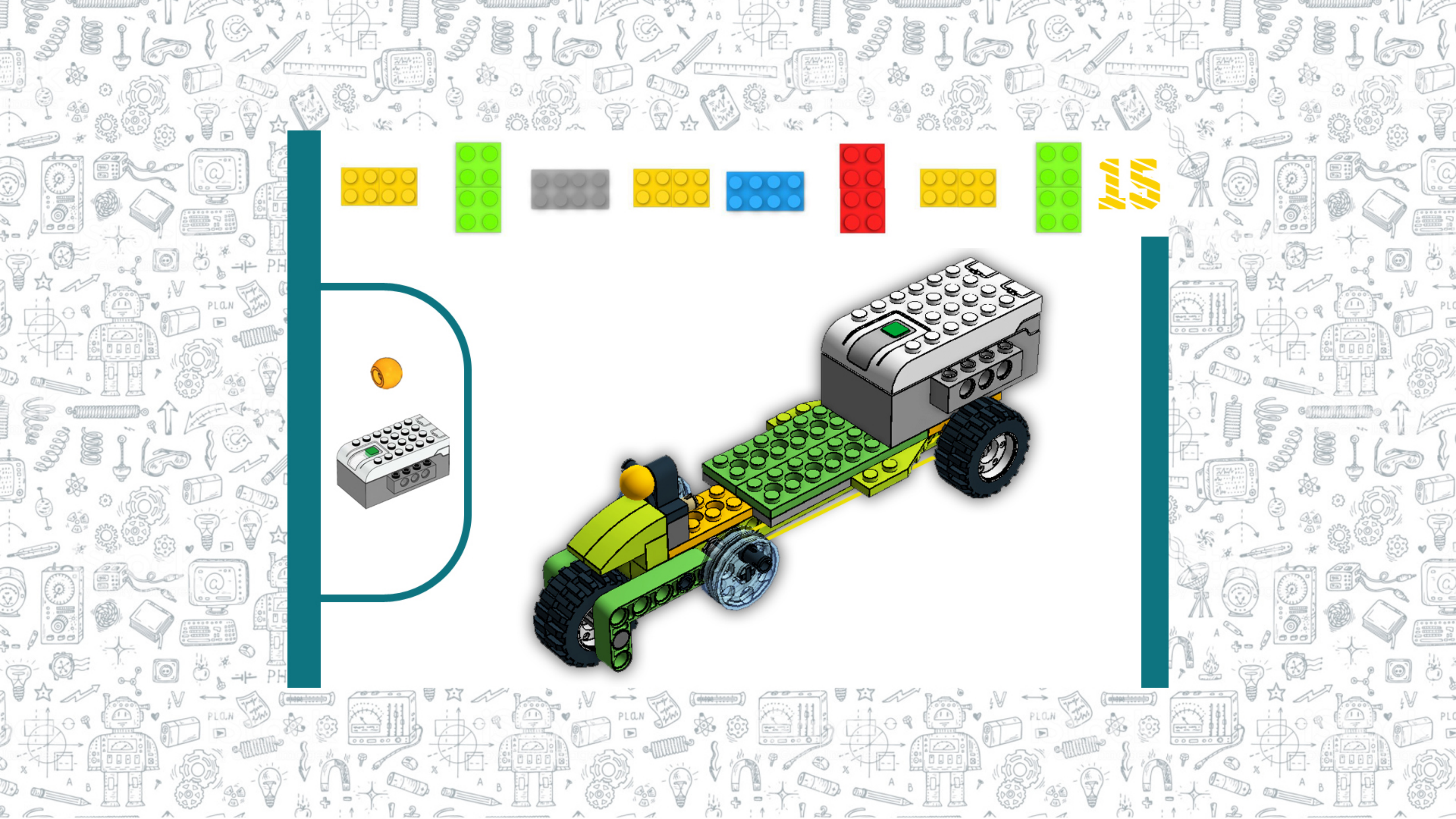





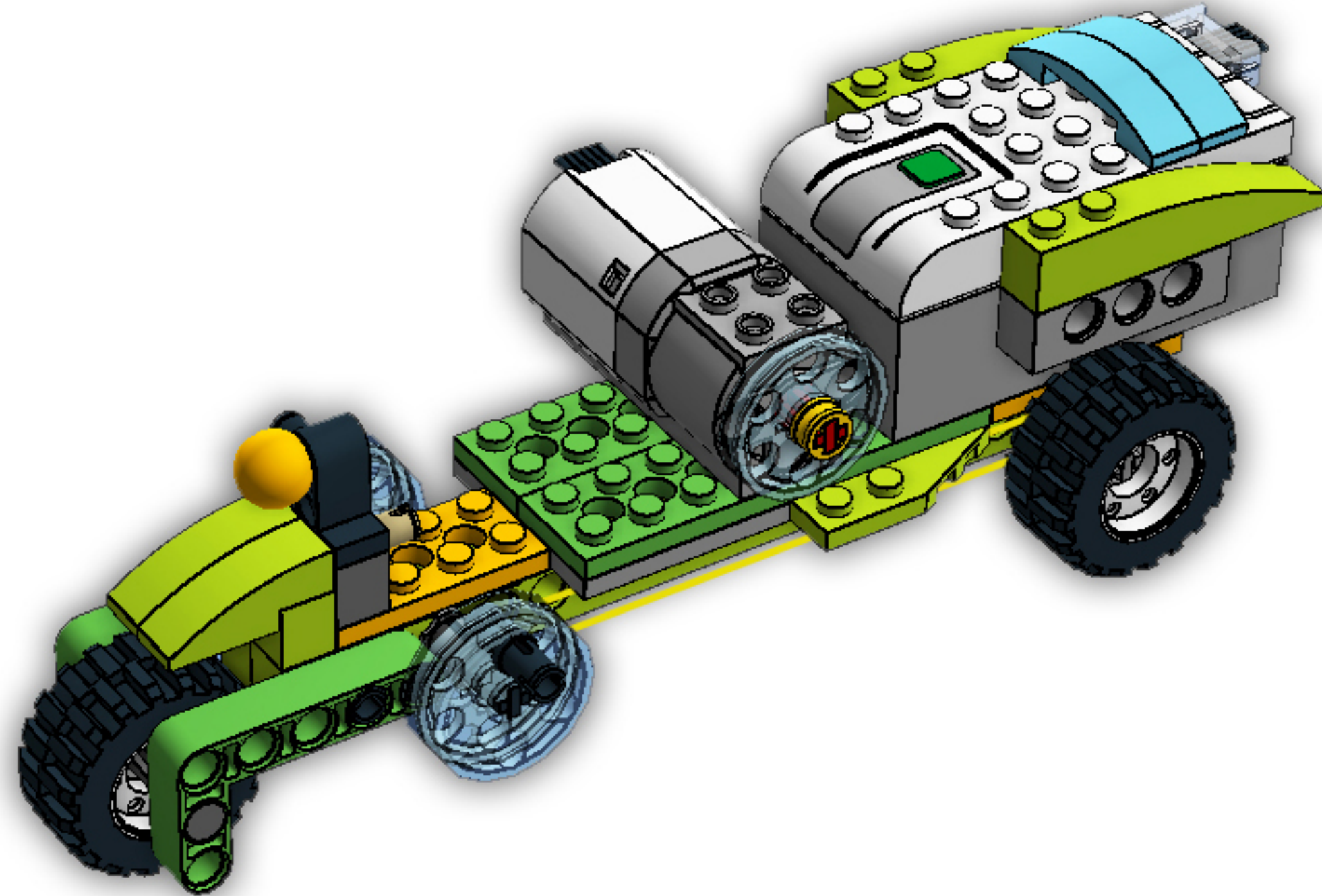
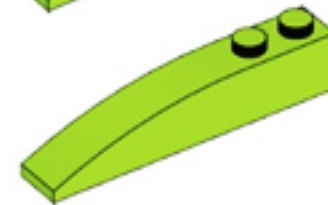
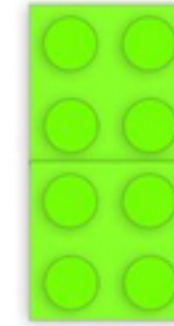
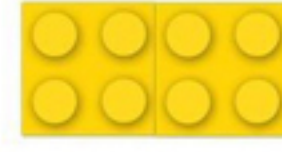
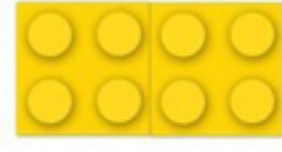
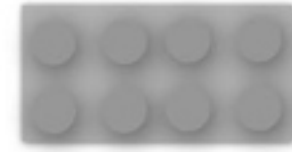
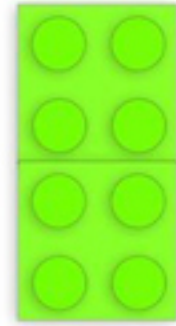

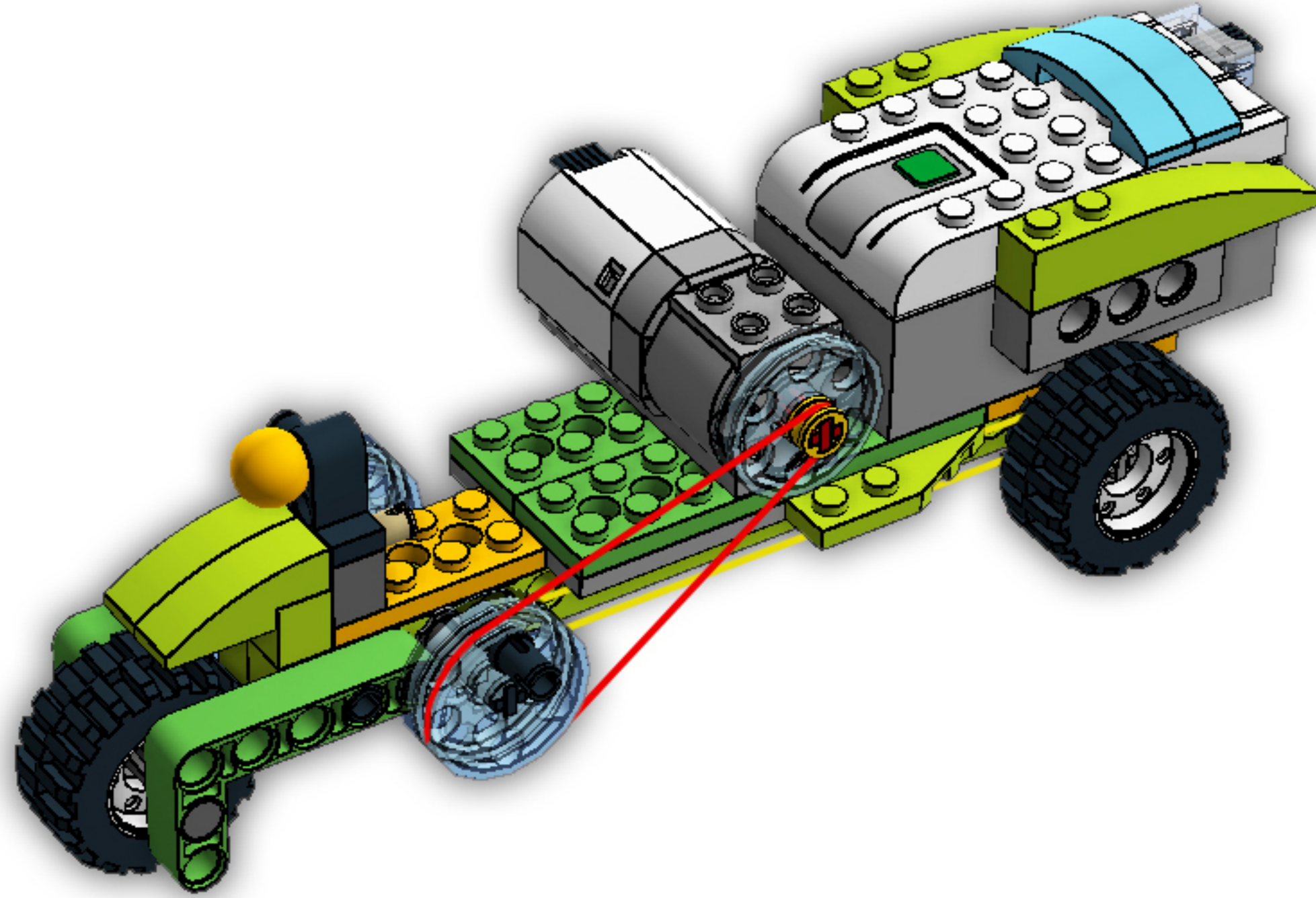
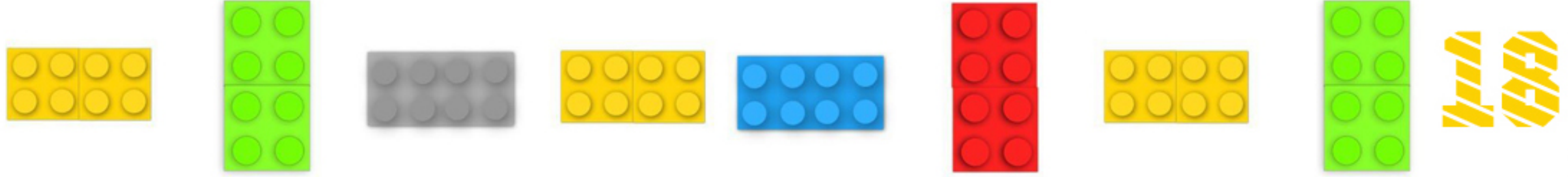
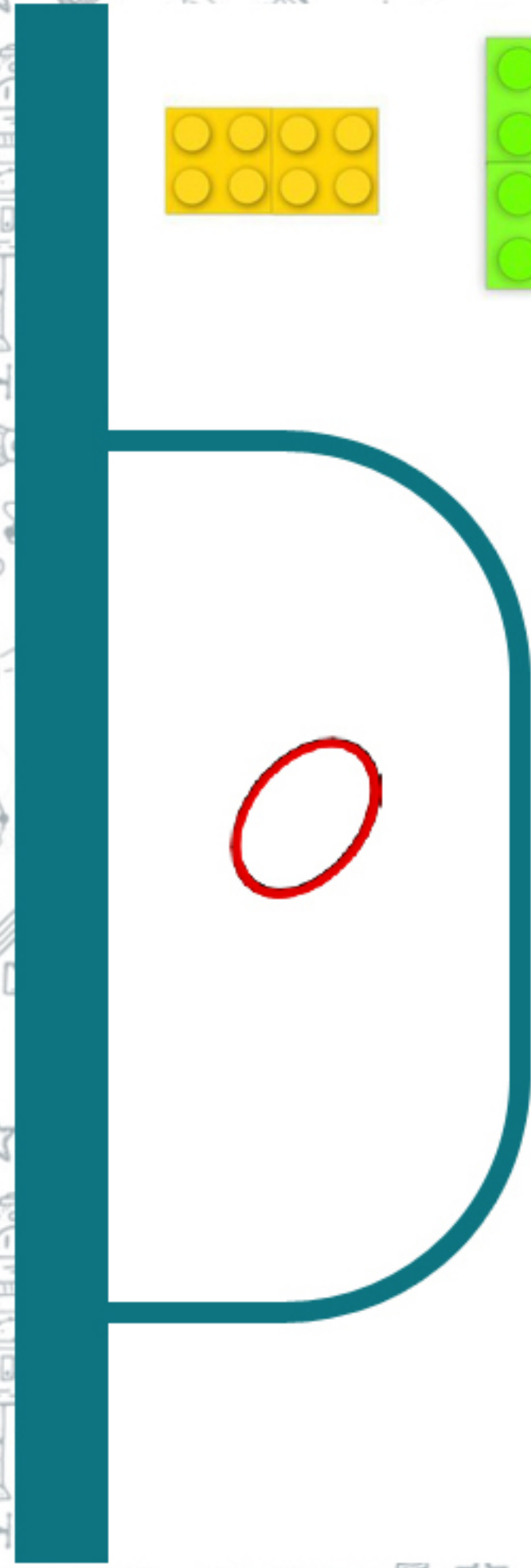

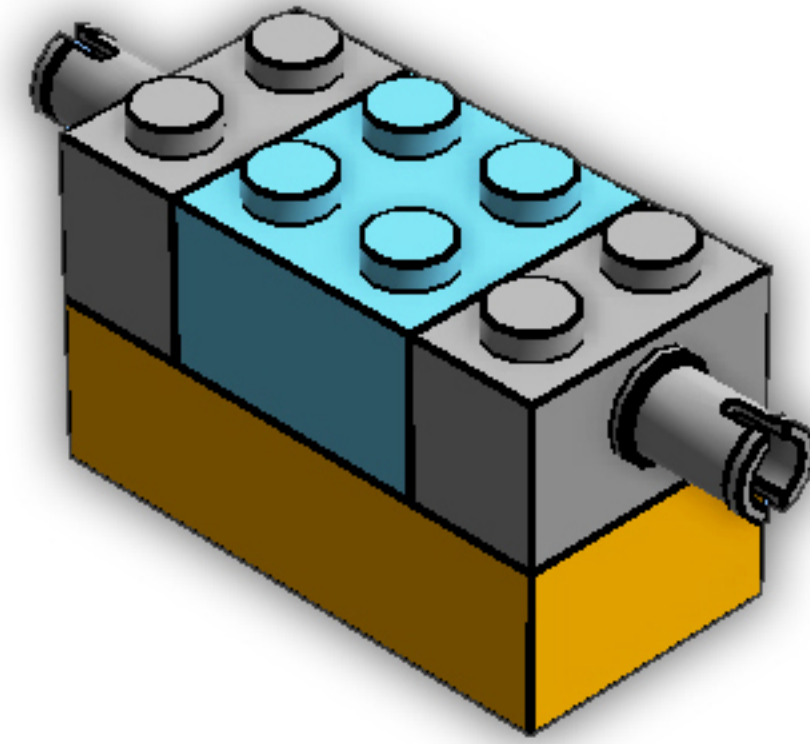
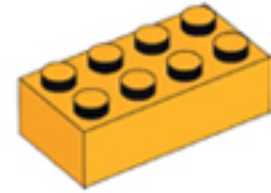
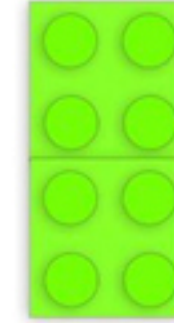
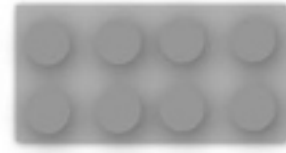
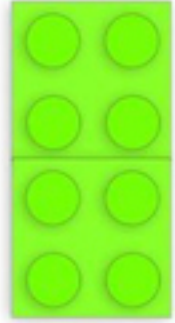
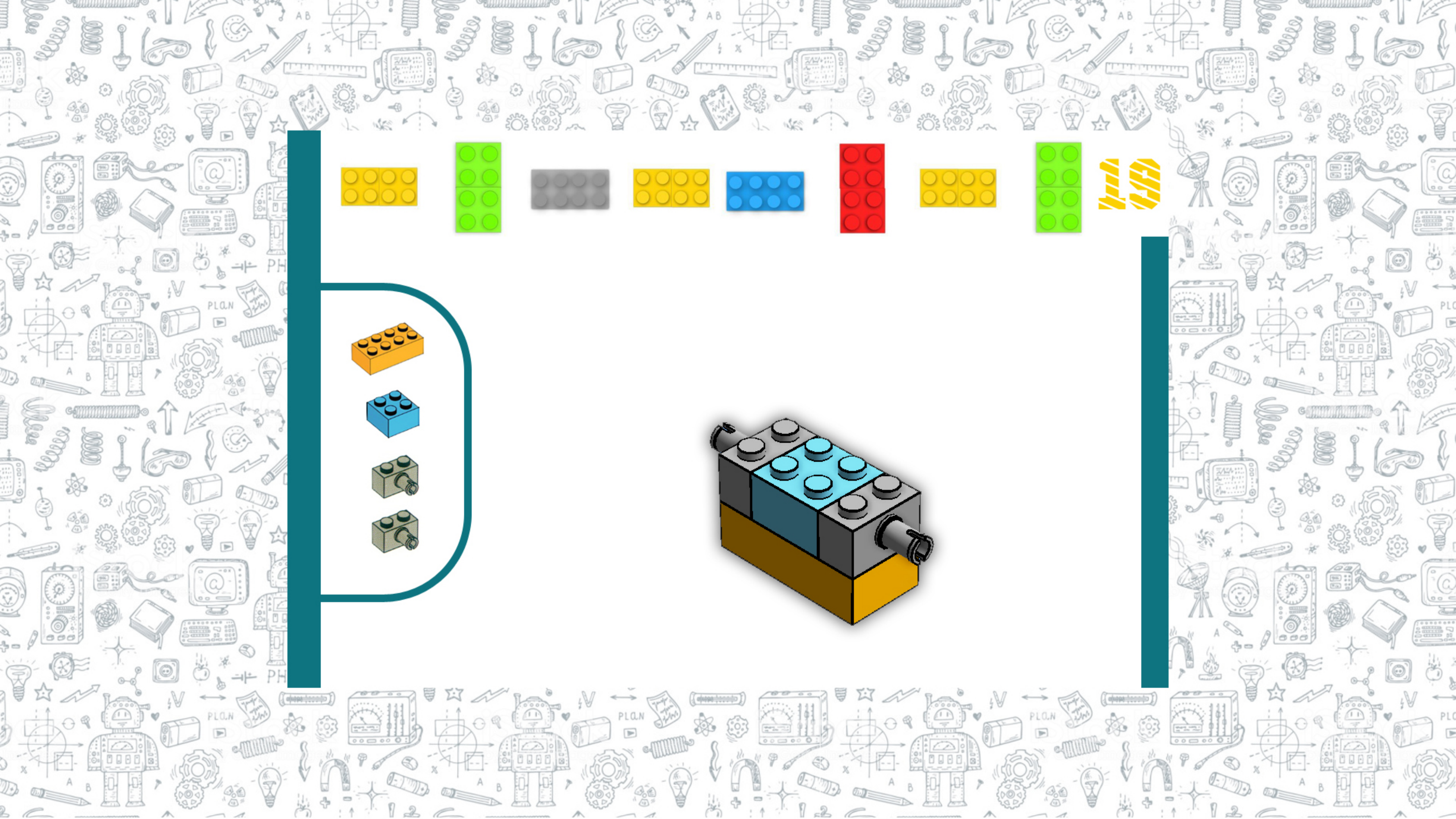

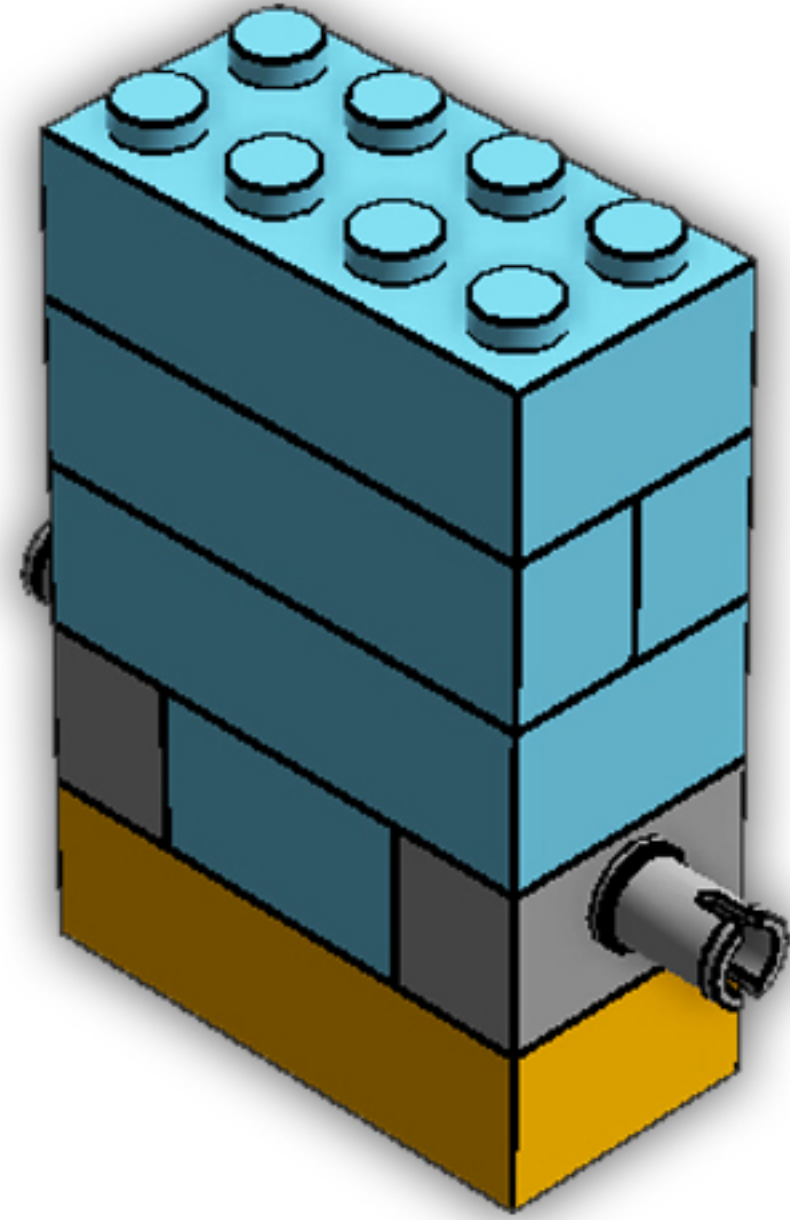
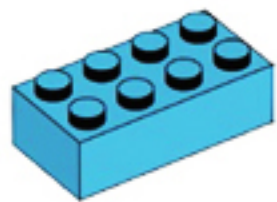
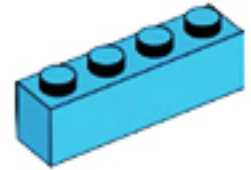
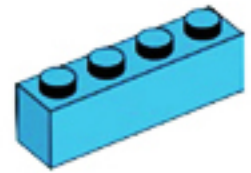
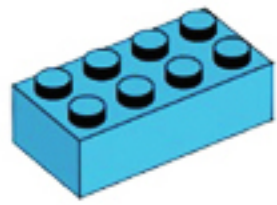
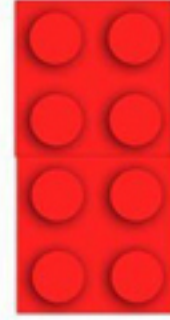
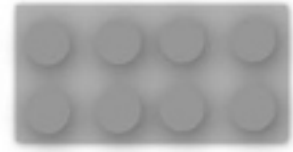
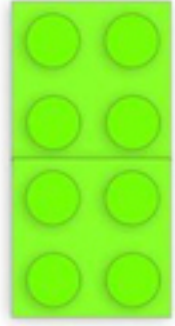
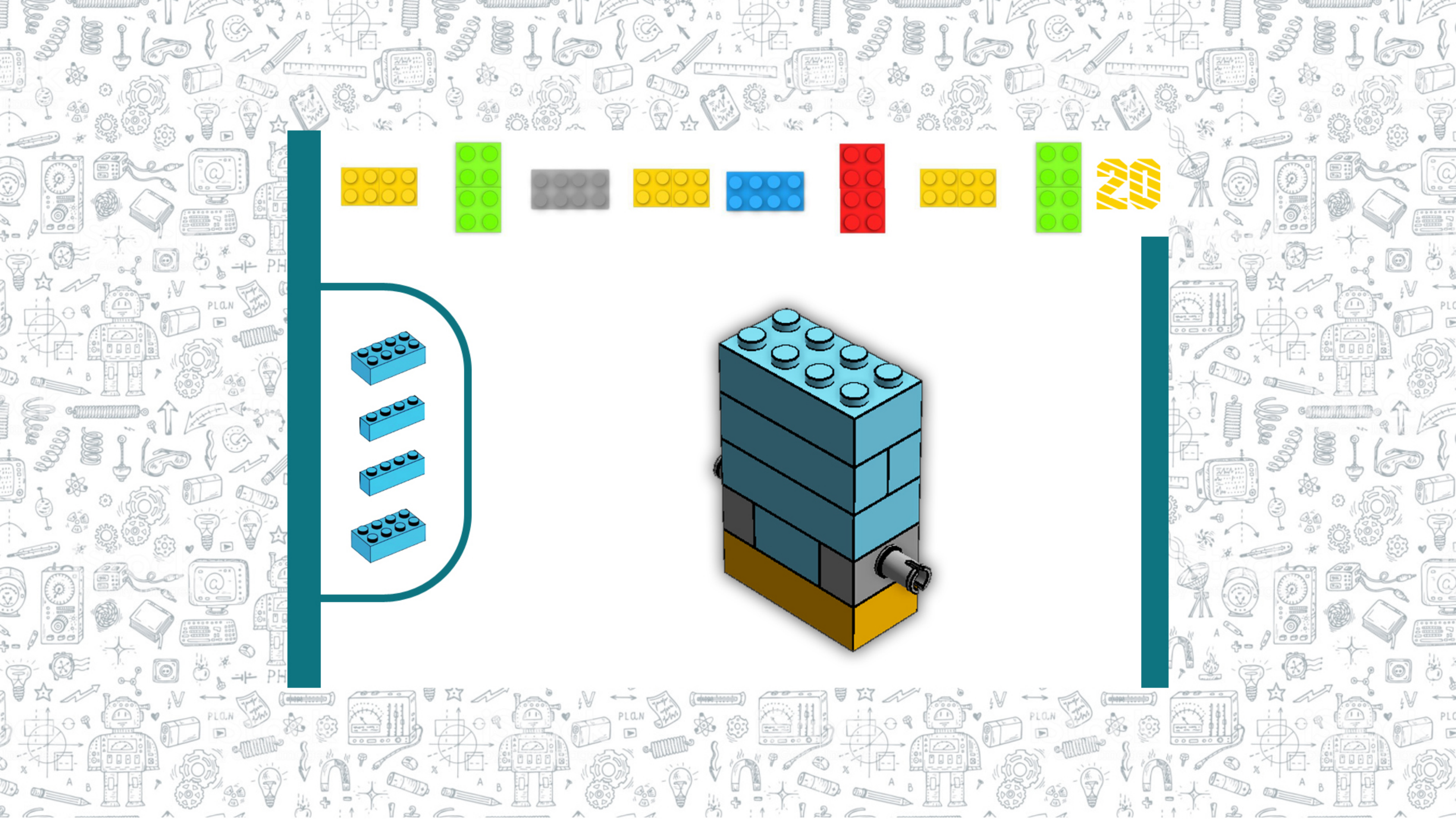

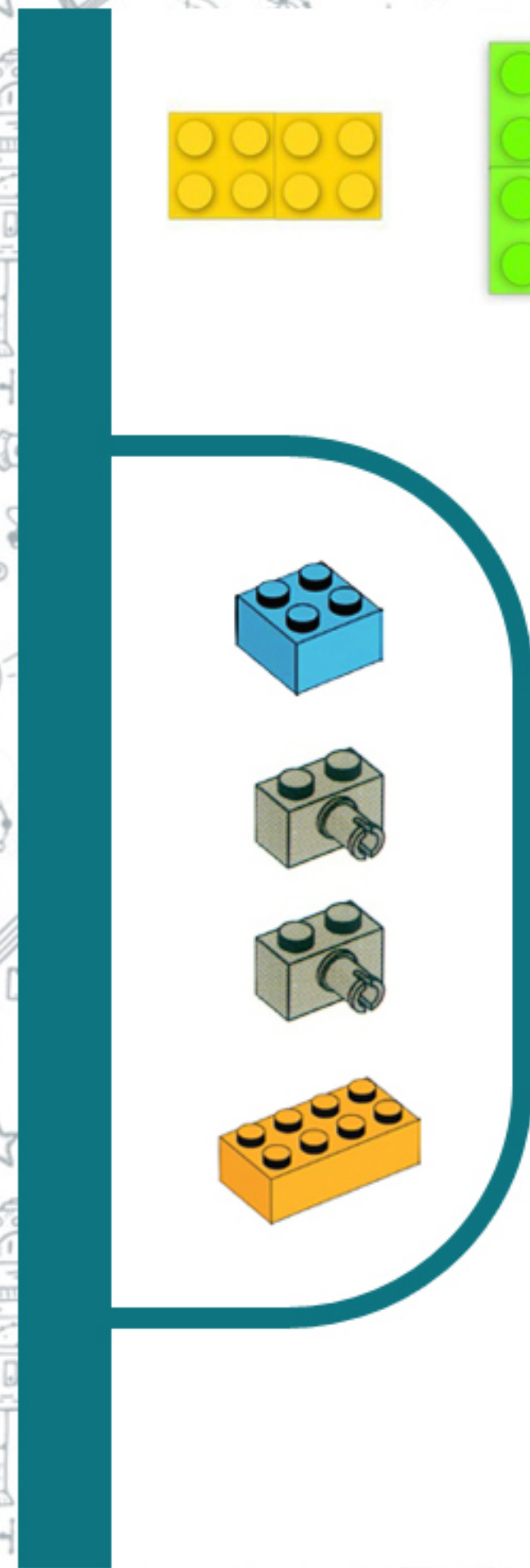
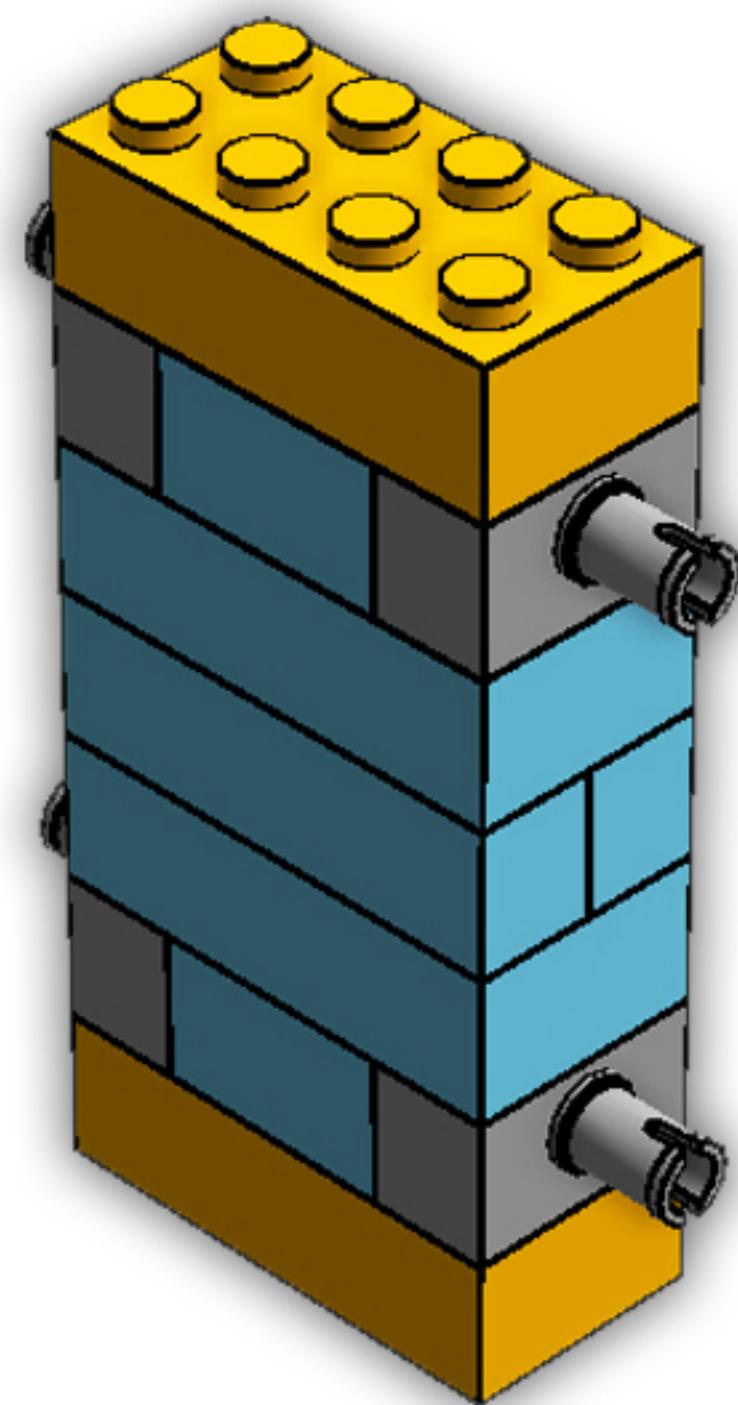
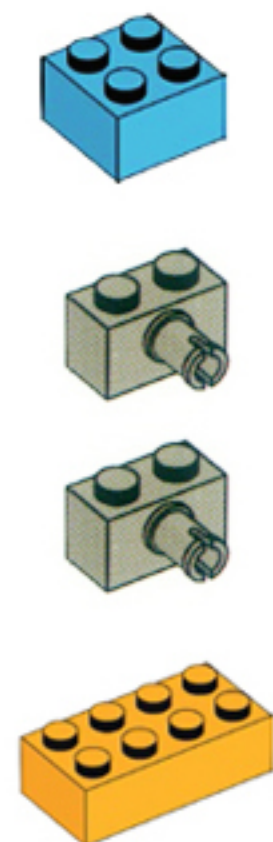
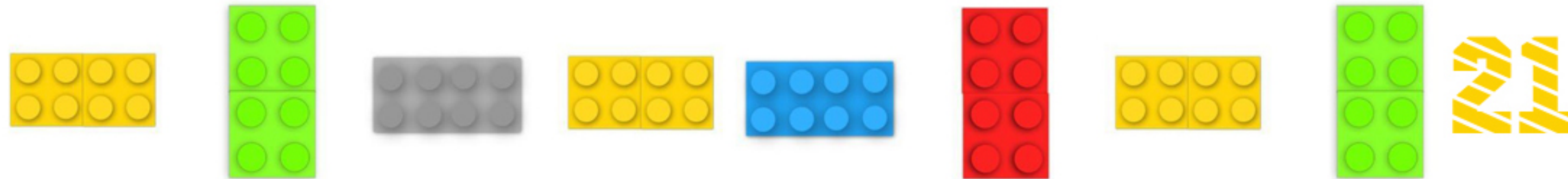
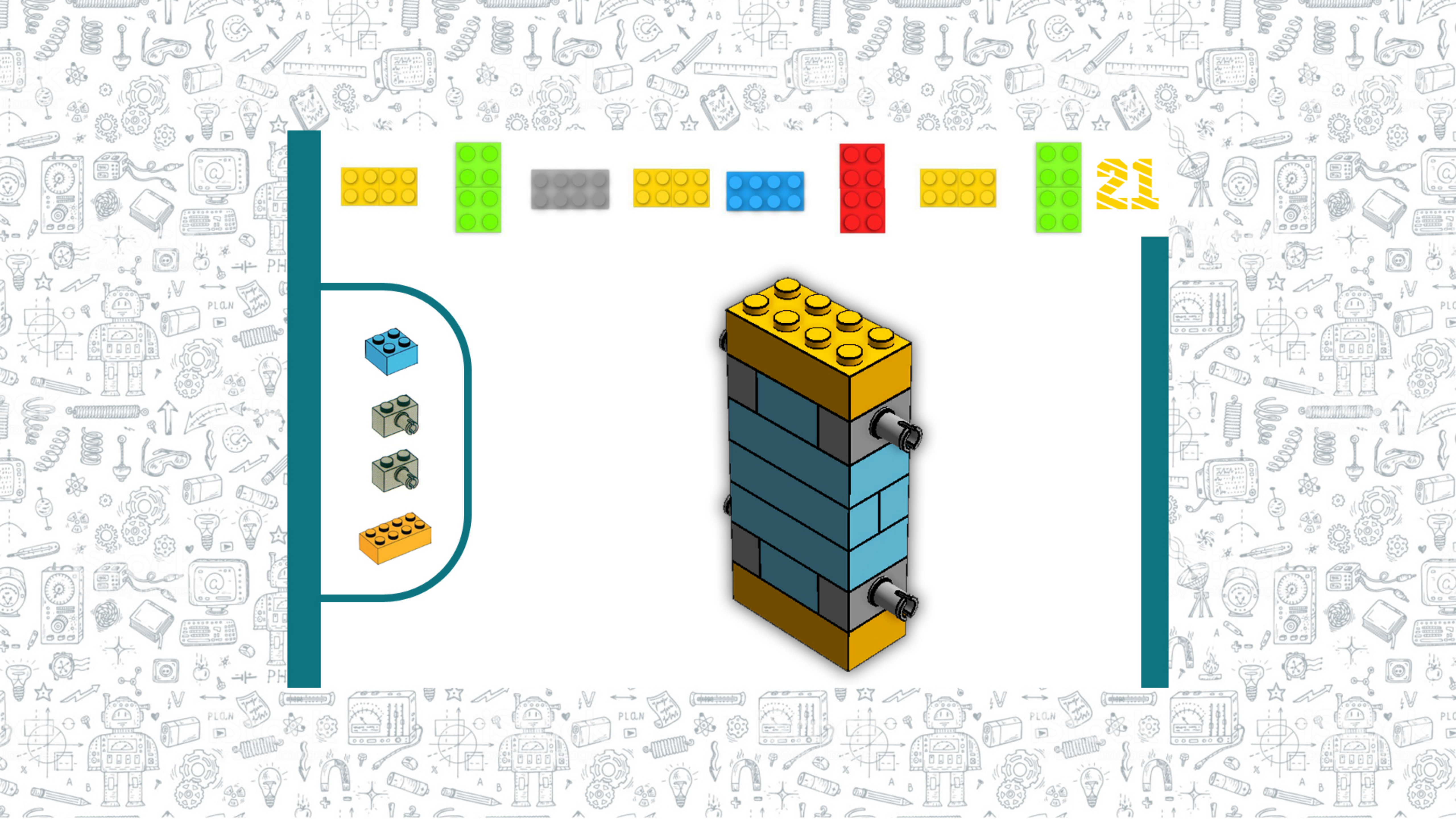



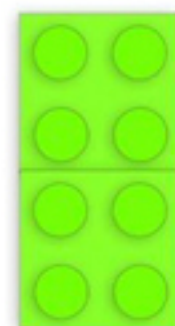
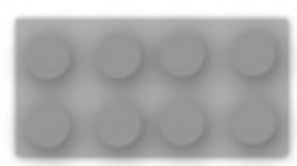
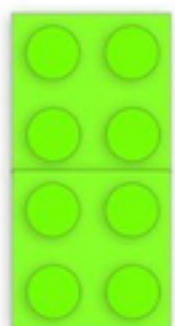
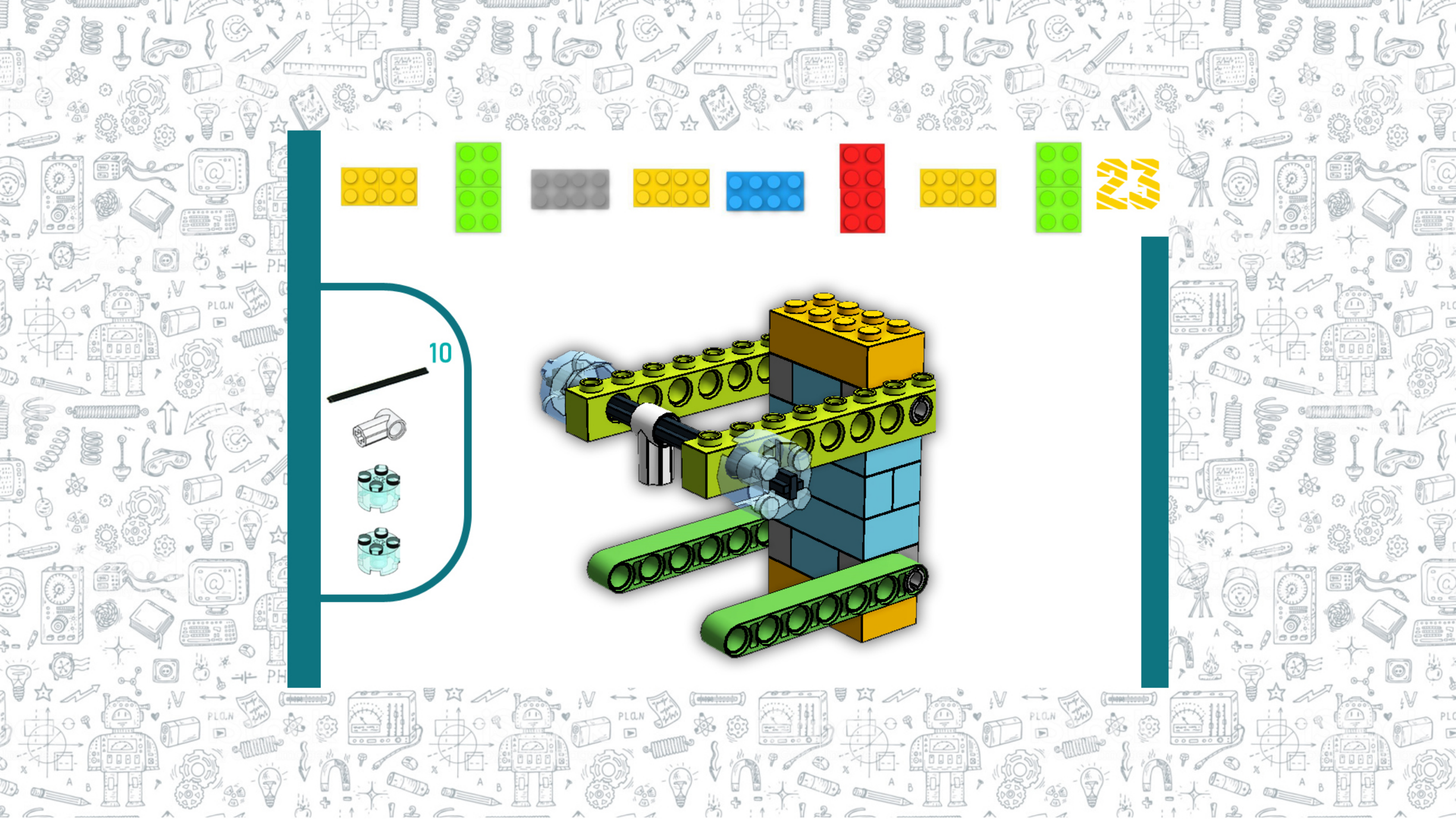

10

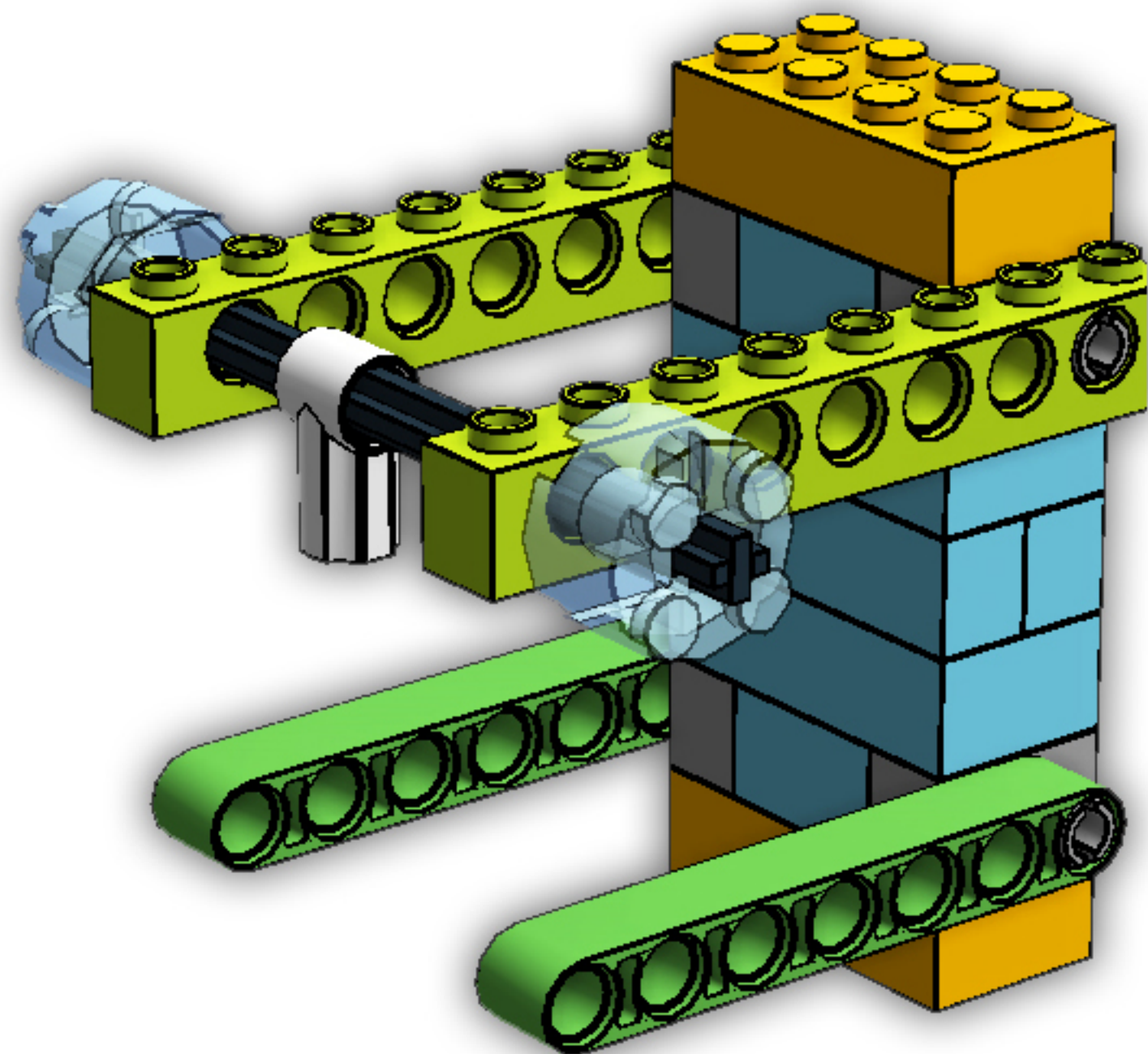



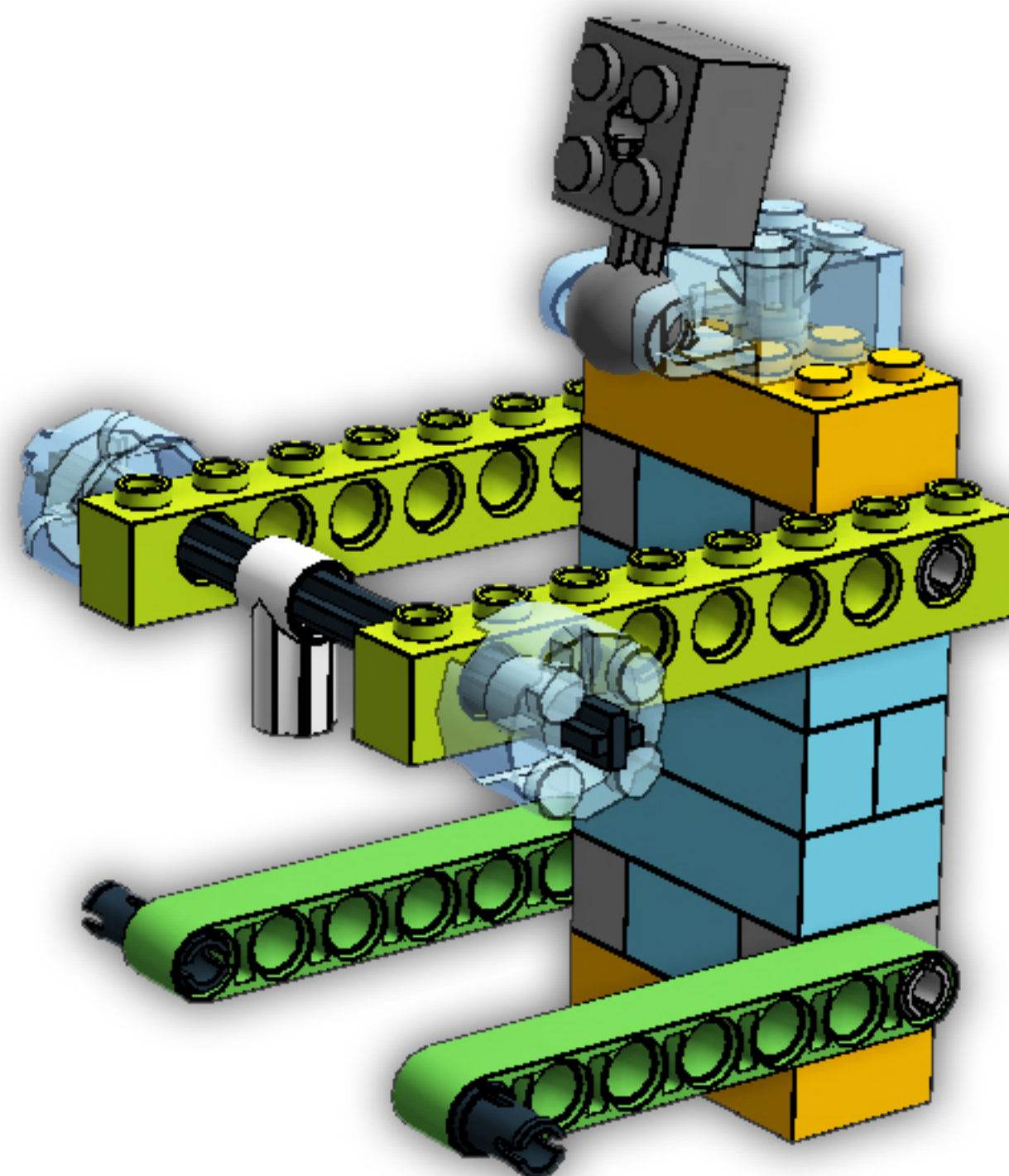
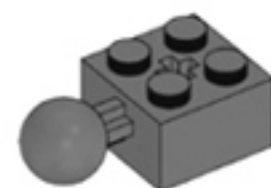
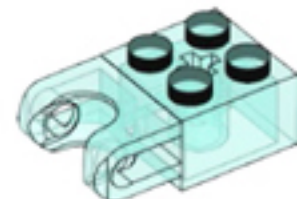
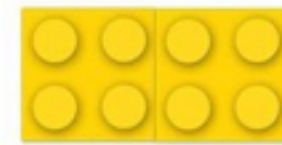
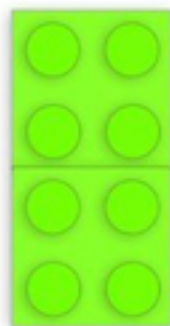
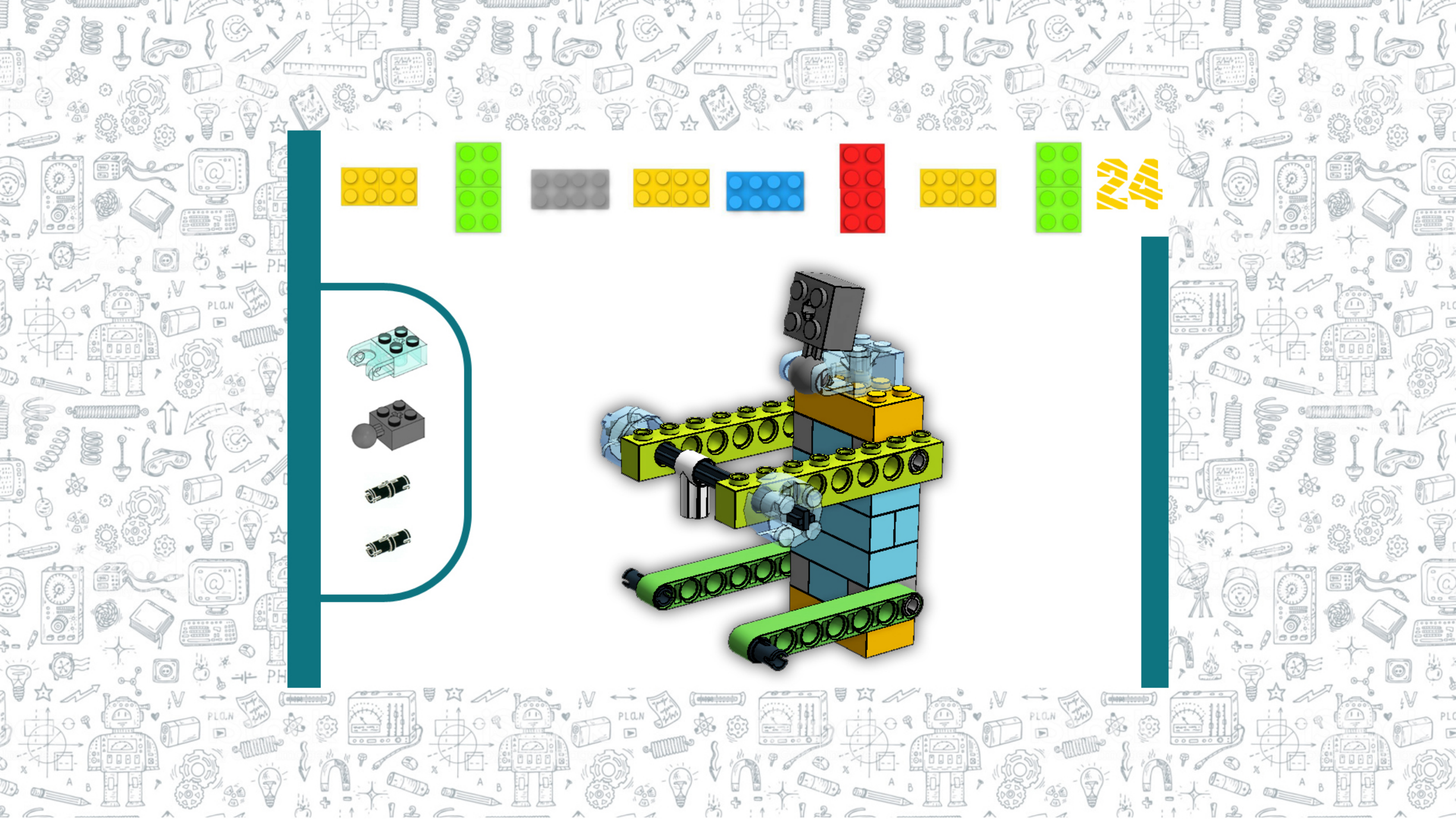

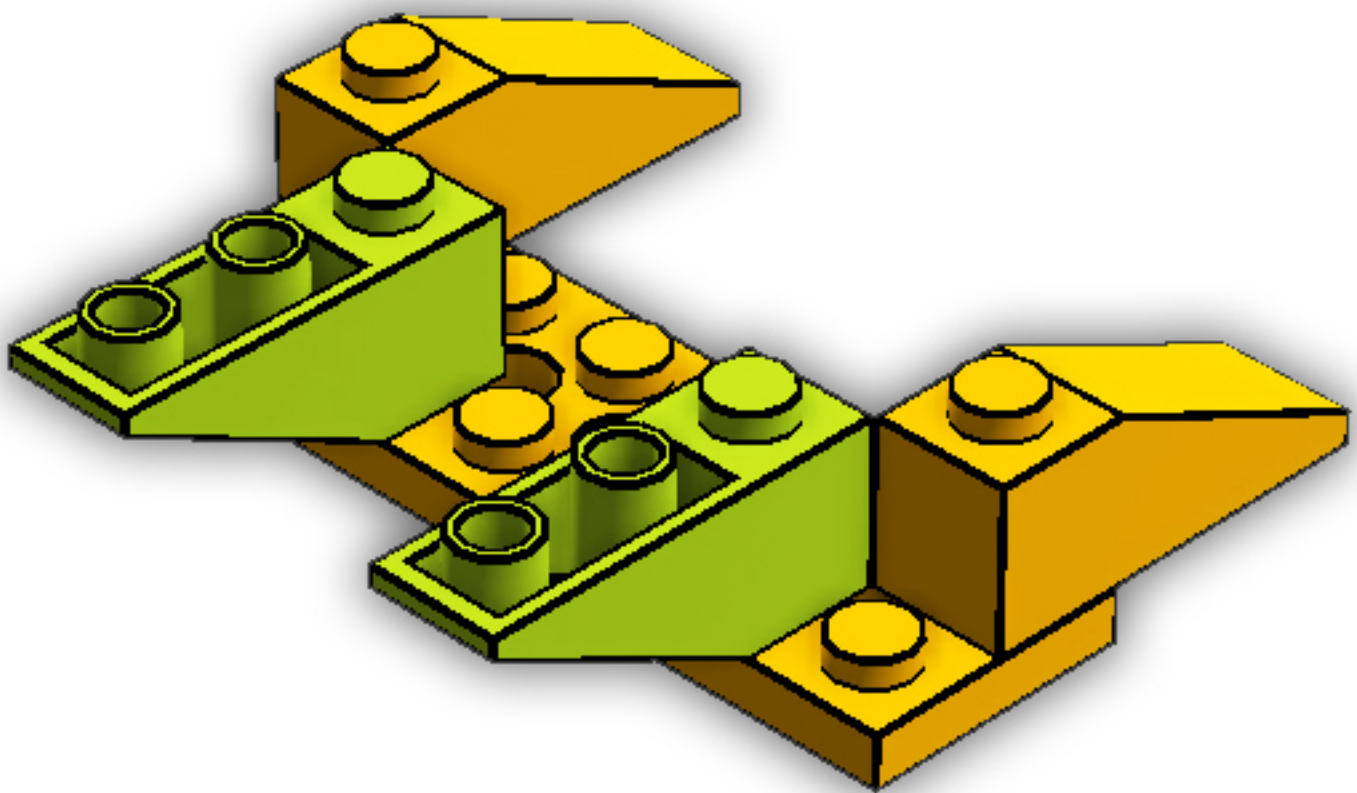
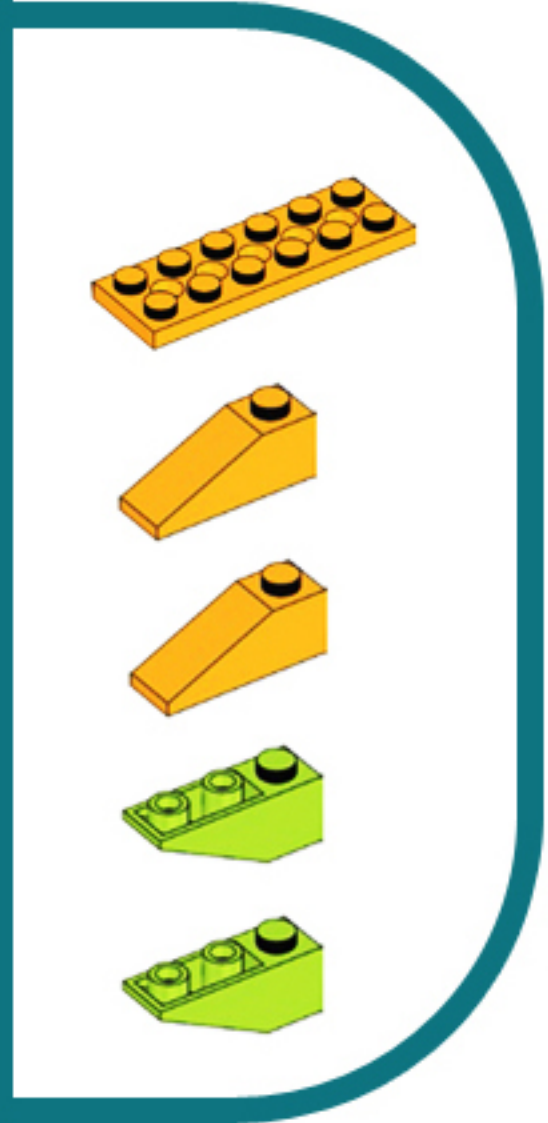
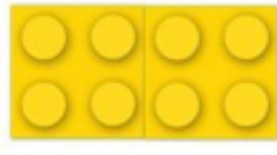
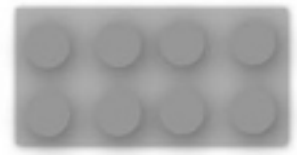
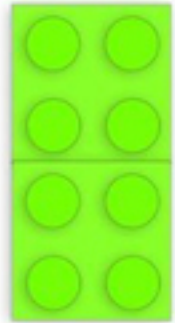
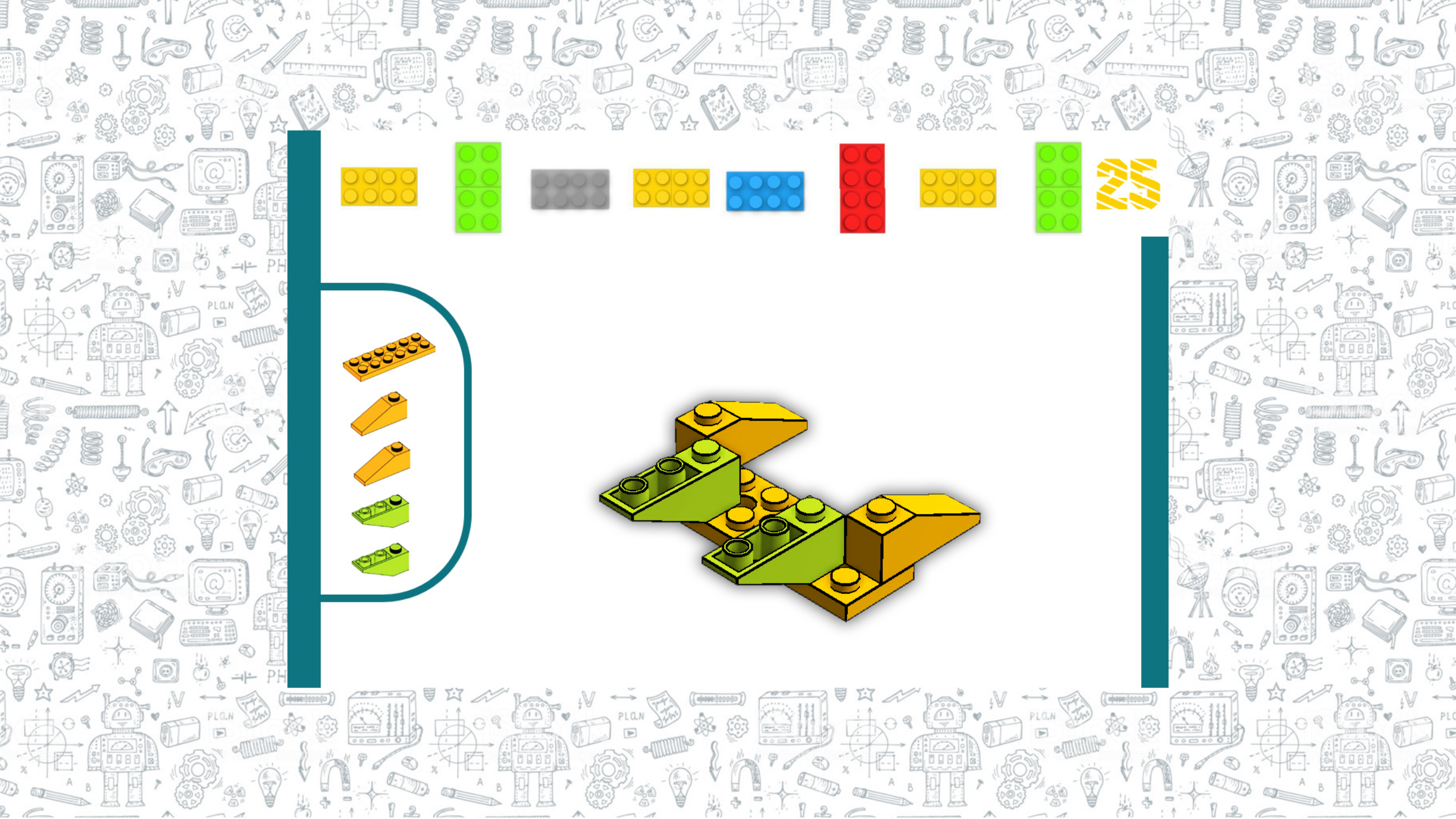

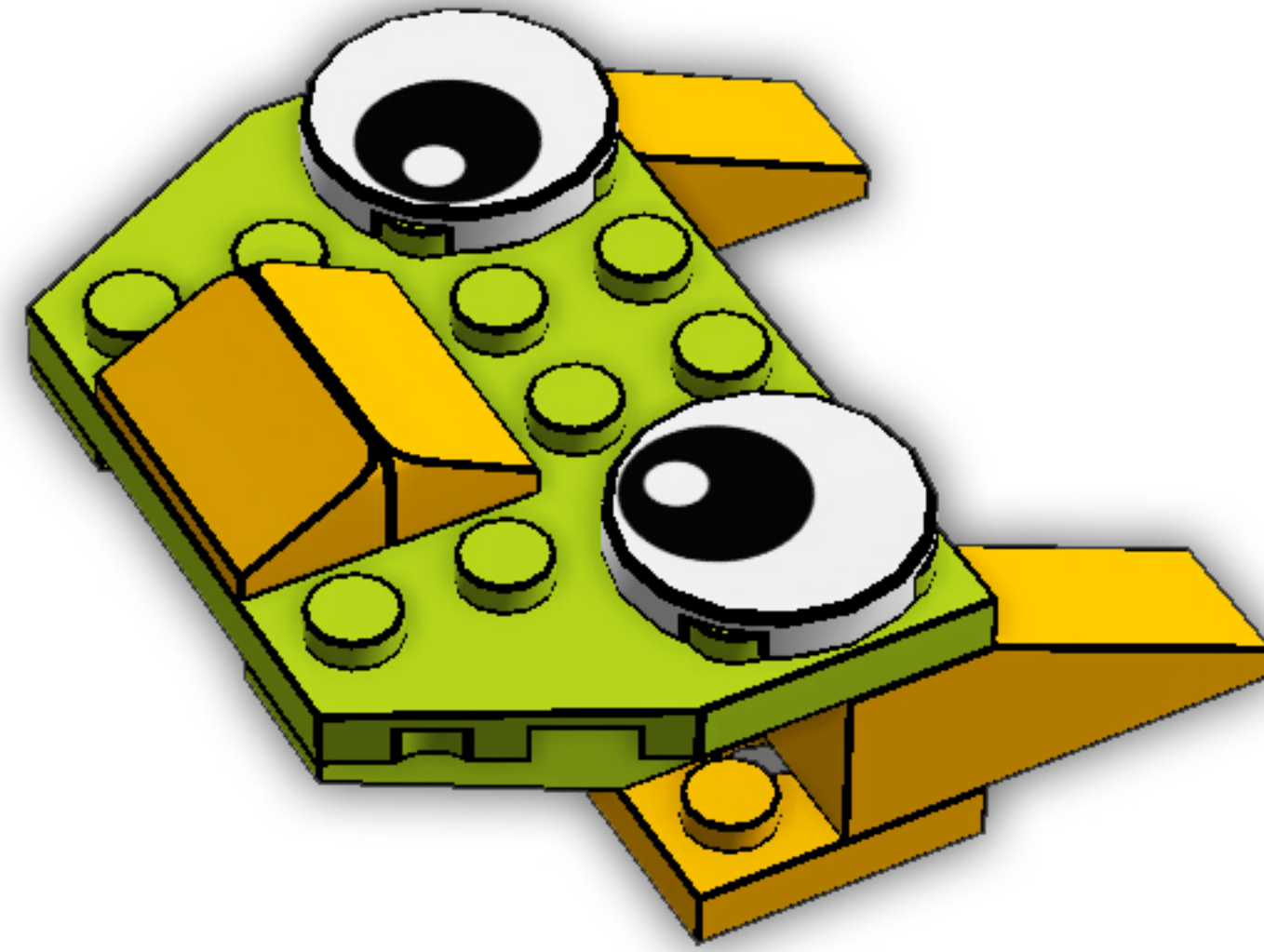
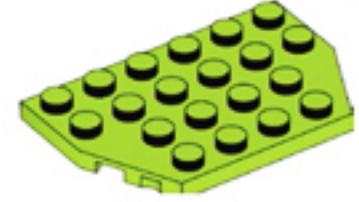
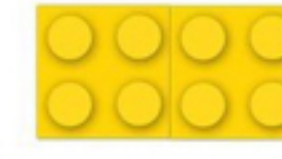
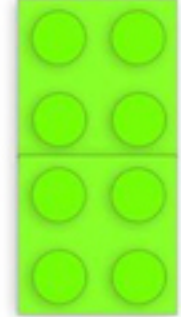
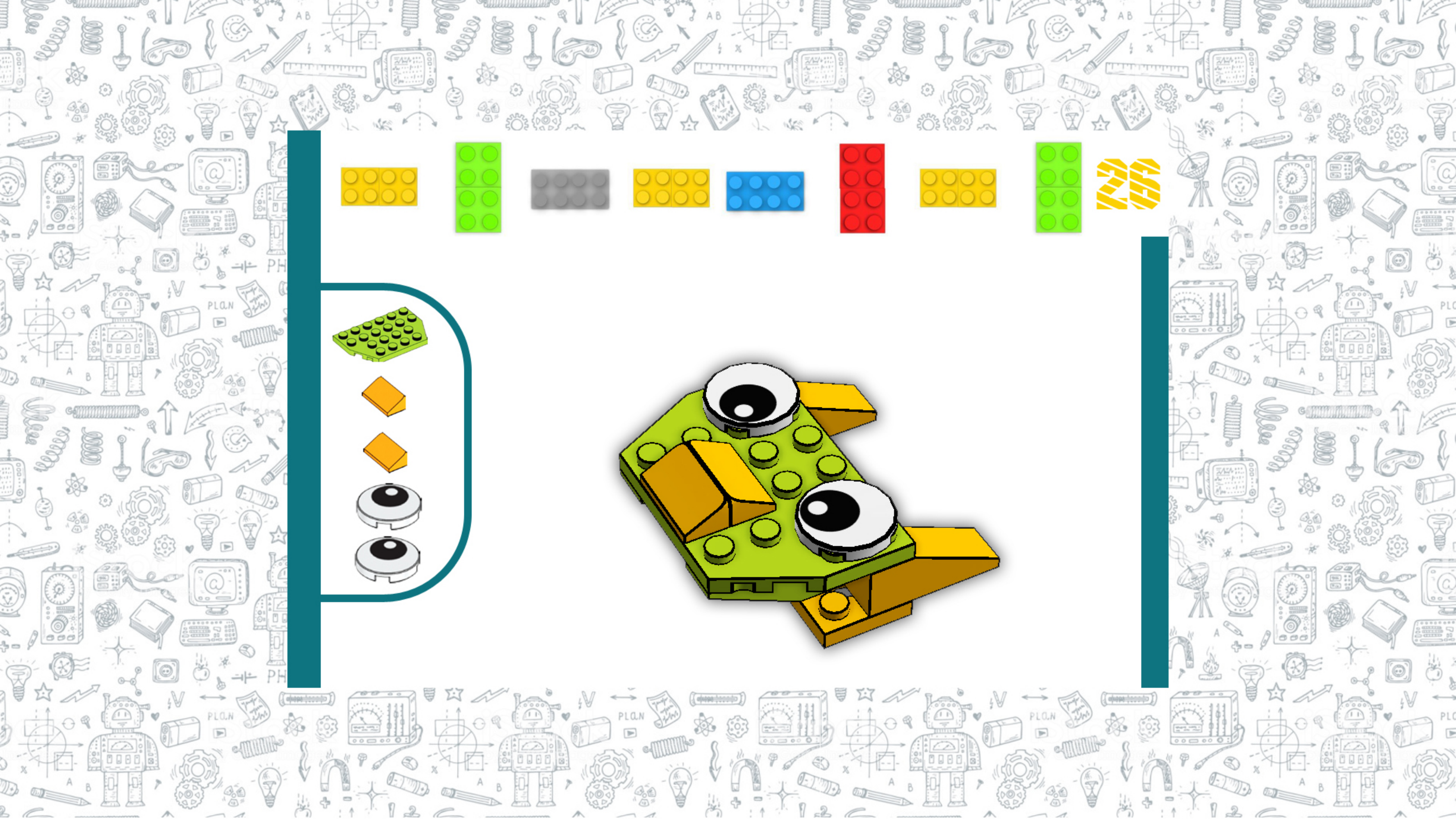



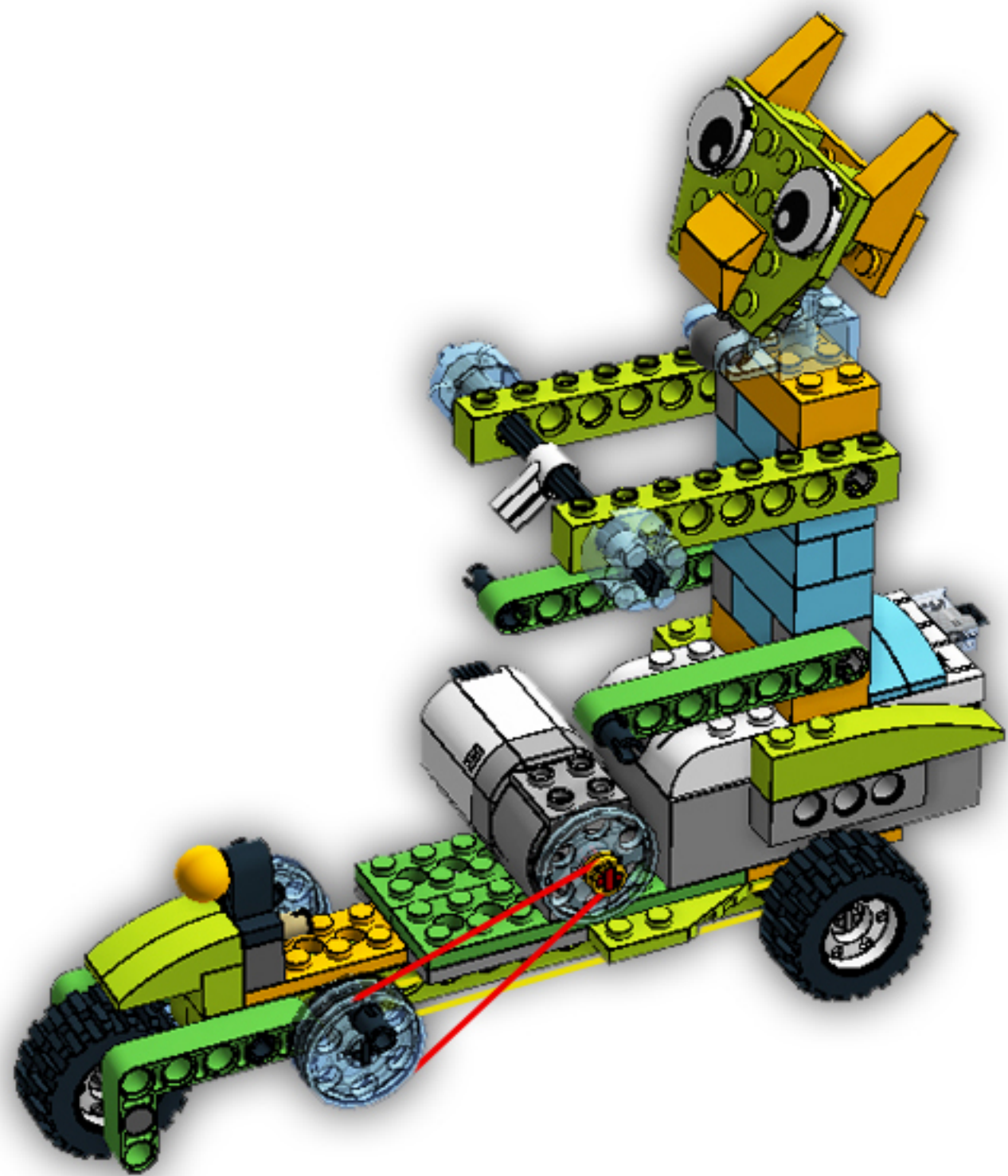
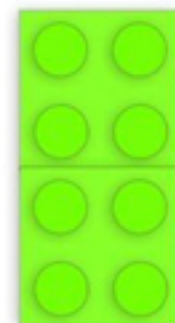
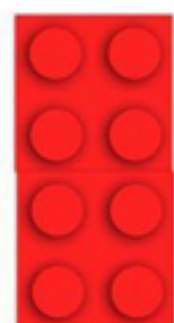
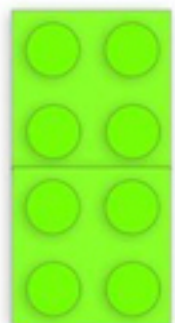
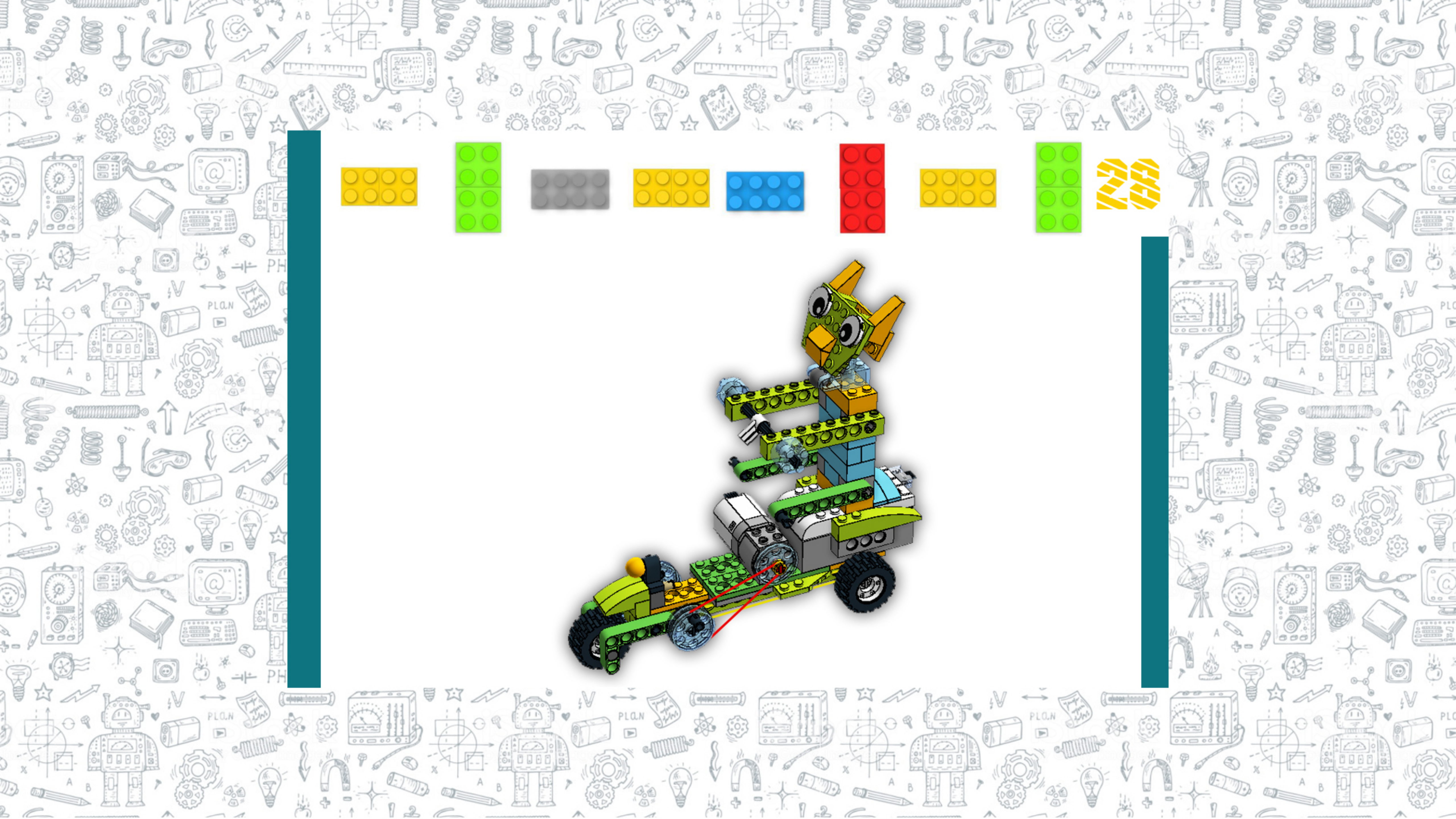

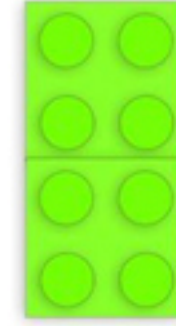
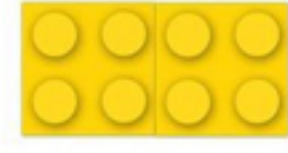
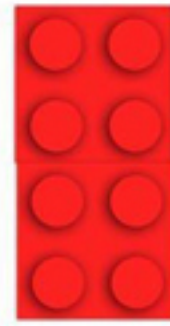
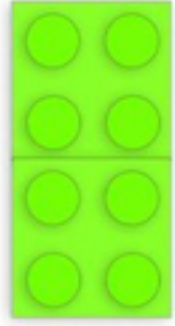
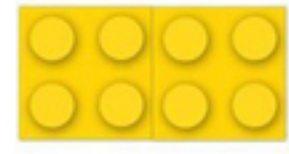

7



3

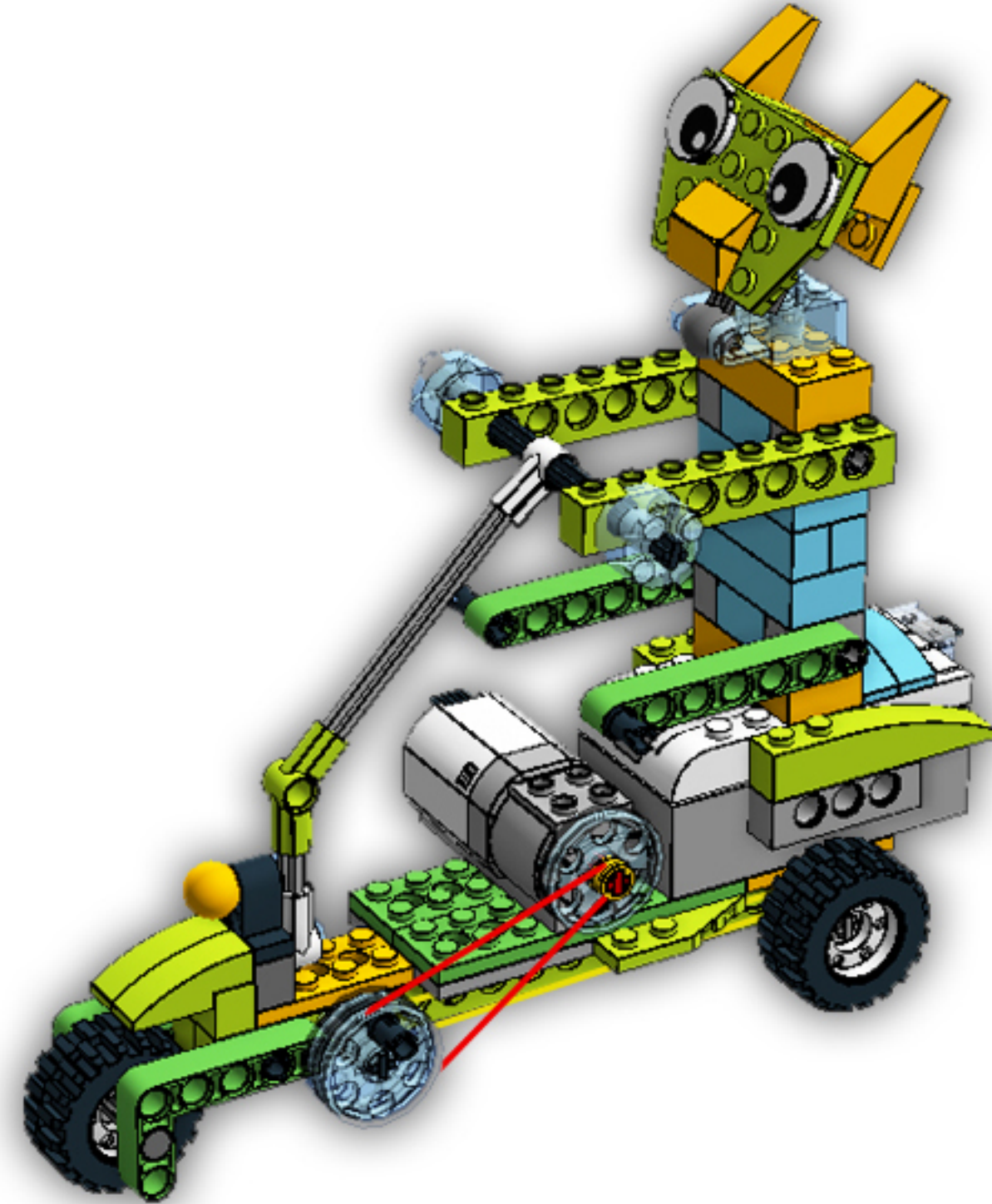

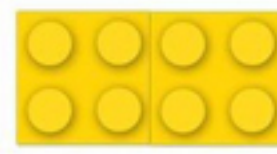
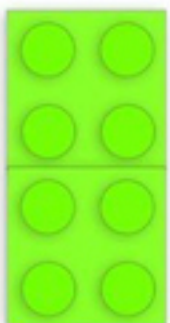

12

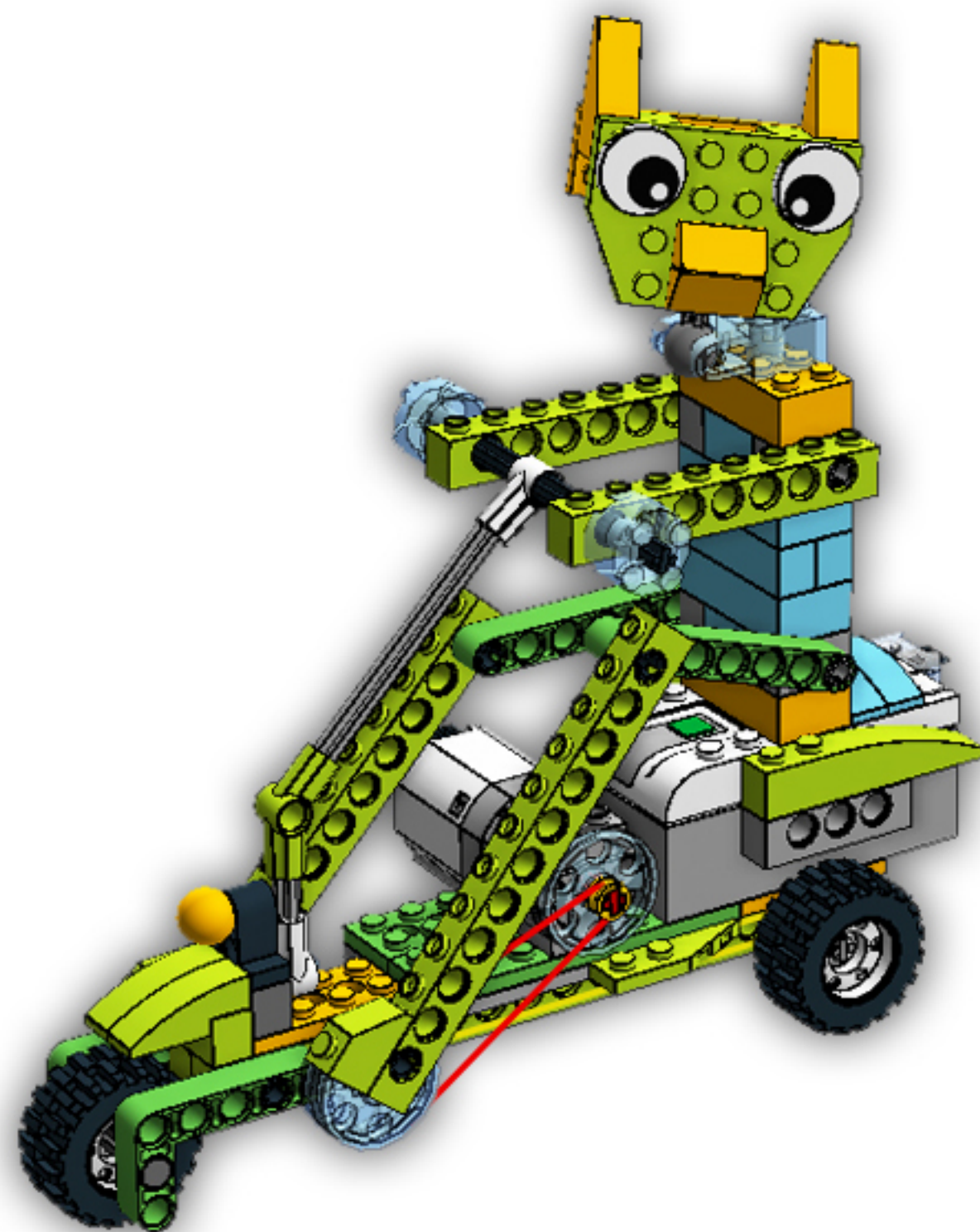
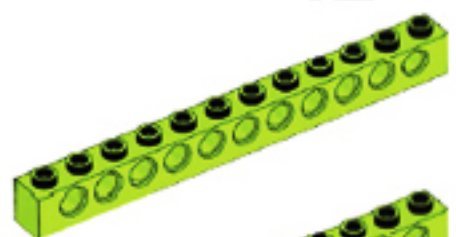

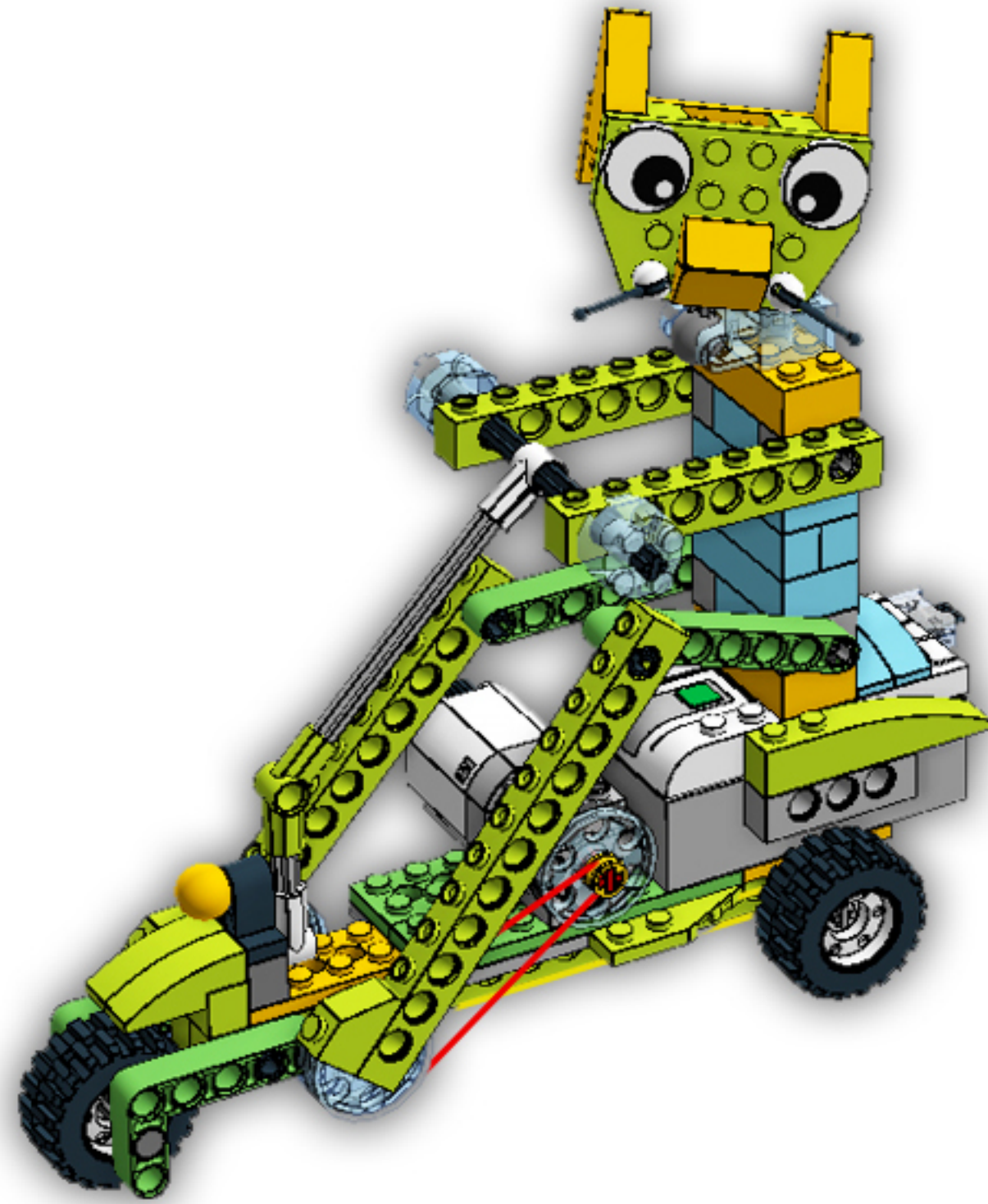
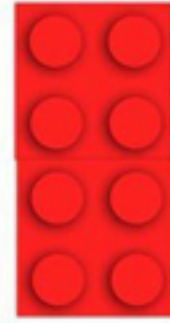
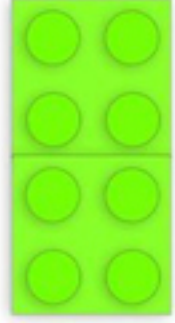
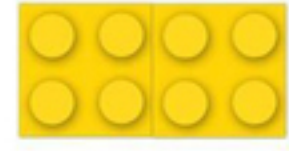
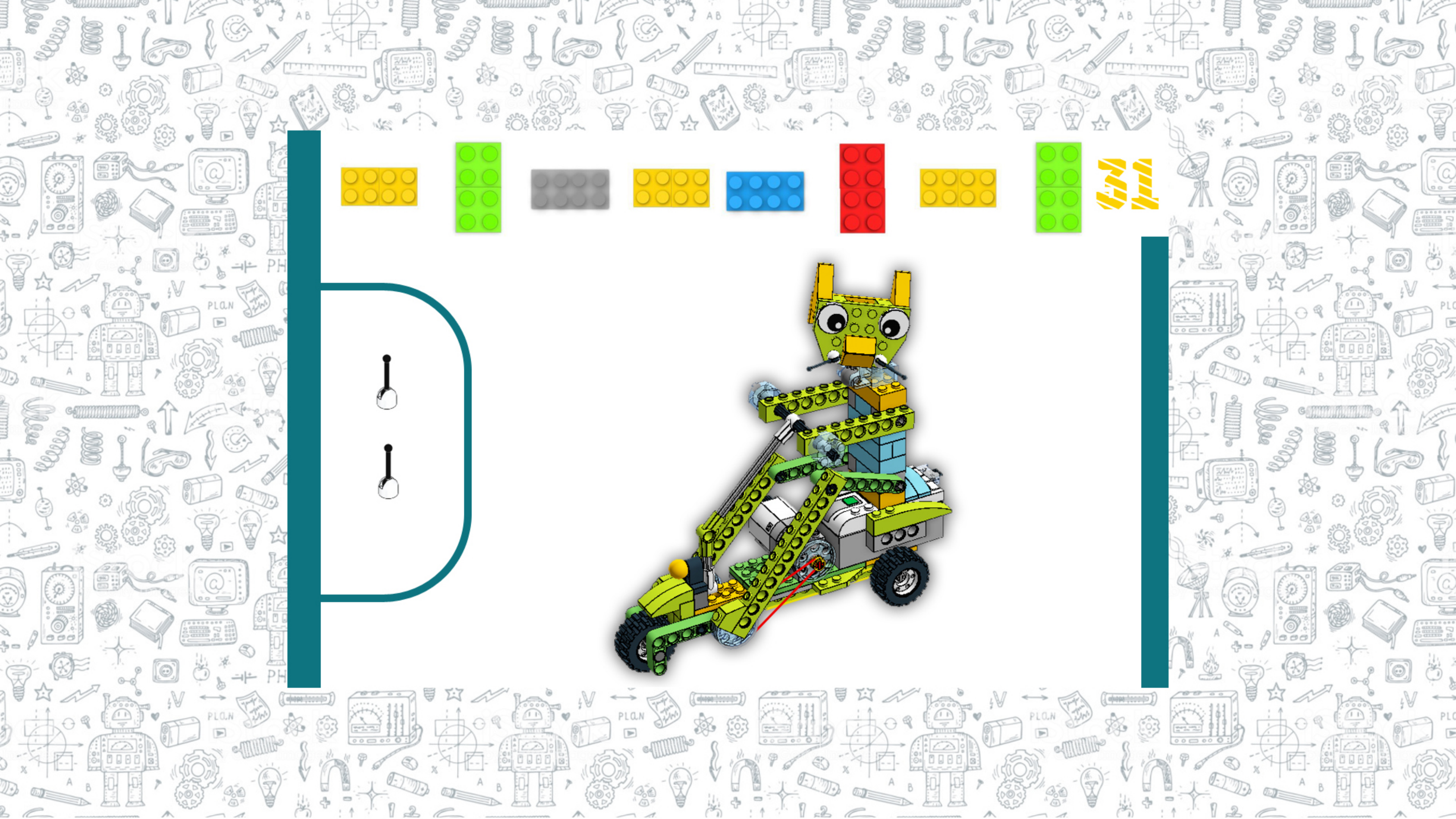



# ВЕЛОКОТ

Выбирай модель для сборки.  
Вклеивай карточку сборки.

СВОБОДНАЯ СБОРКА





Составь программу для движения модели вперёд. Используй правильный порядок блоков (отметь его цифрами).



2



Добавь в программу блоки "Случайная мощность мотора". Обведи пару блоков, которую ты будешь использовать.



Запусти модель 3 раза из одной точки в одинаковом направлении.

Отметь место, где Велокот остановился в первую попытку =>



Во вторую попытку ==>



В третью попытку ===>



Объясни, почему расстояние оказалось разным.

