

# Hungry crocodile

Fingers and food detector

Adaptation of WeDo 1



Academia creativa de tecnología

# Tecnoaprendo

1

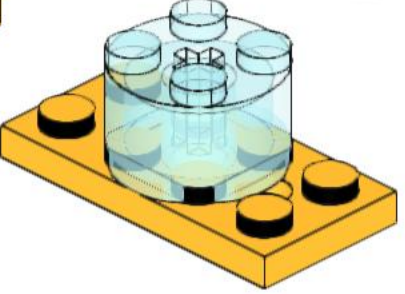
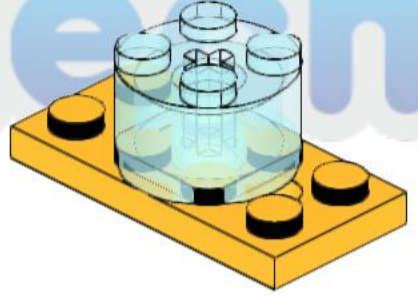
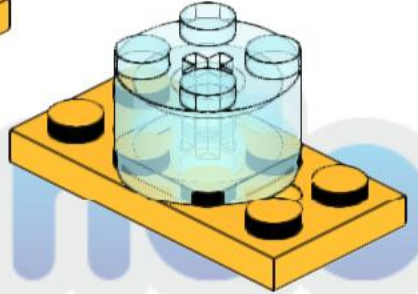
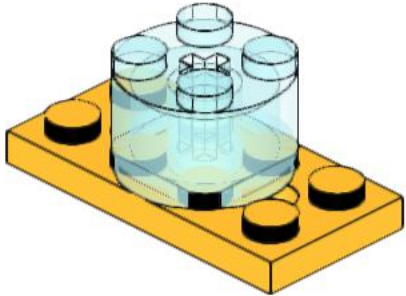
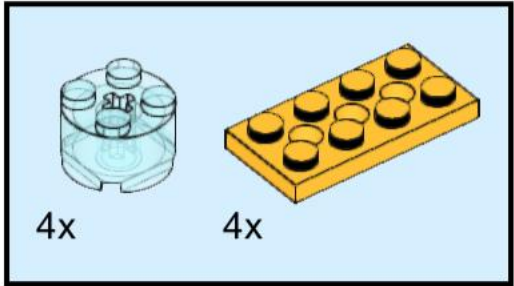

Technoaprentis

2

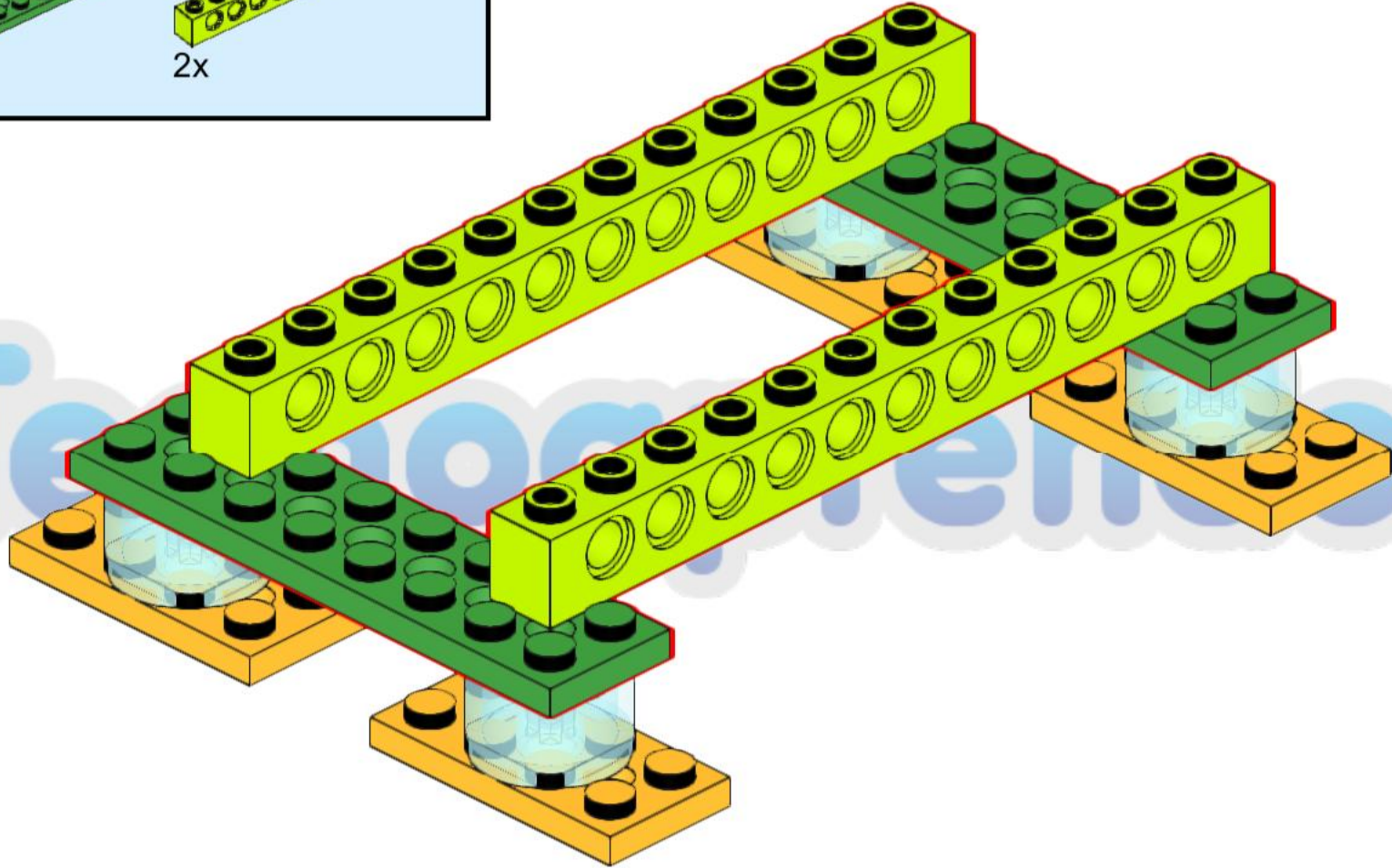
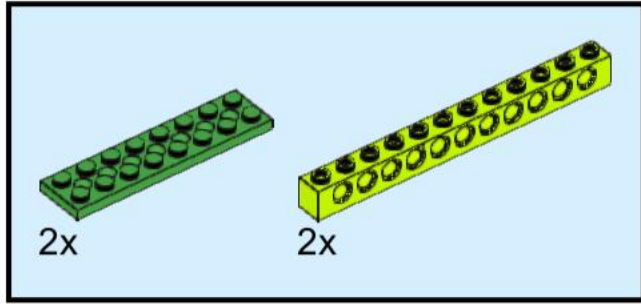



3

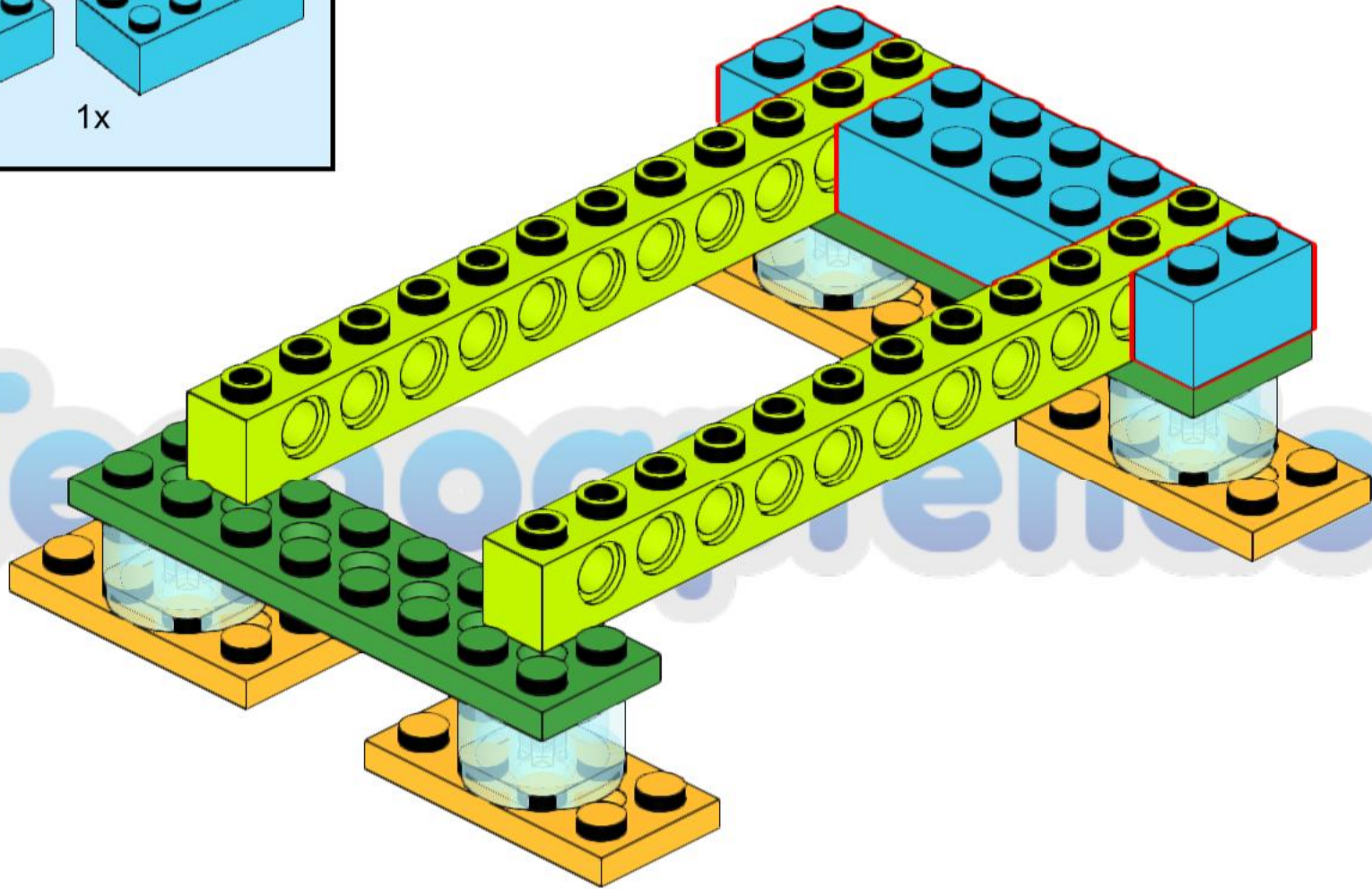
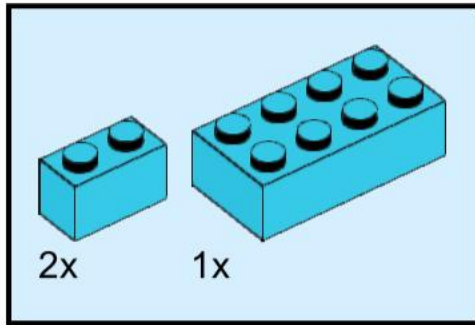

4

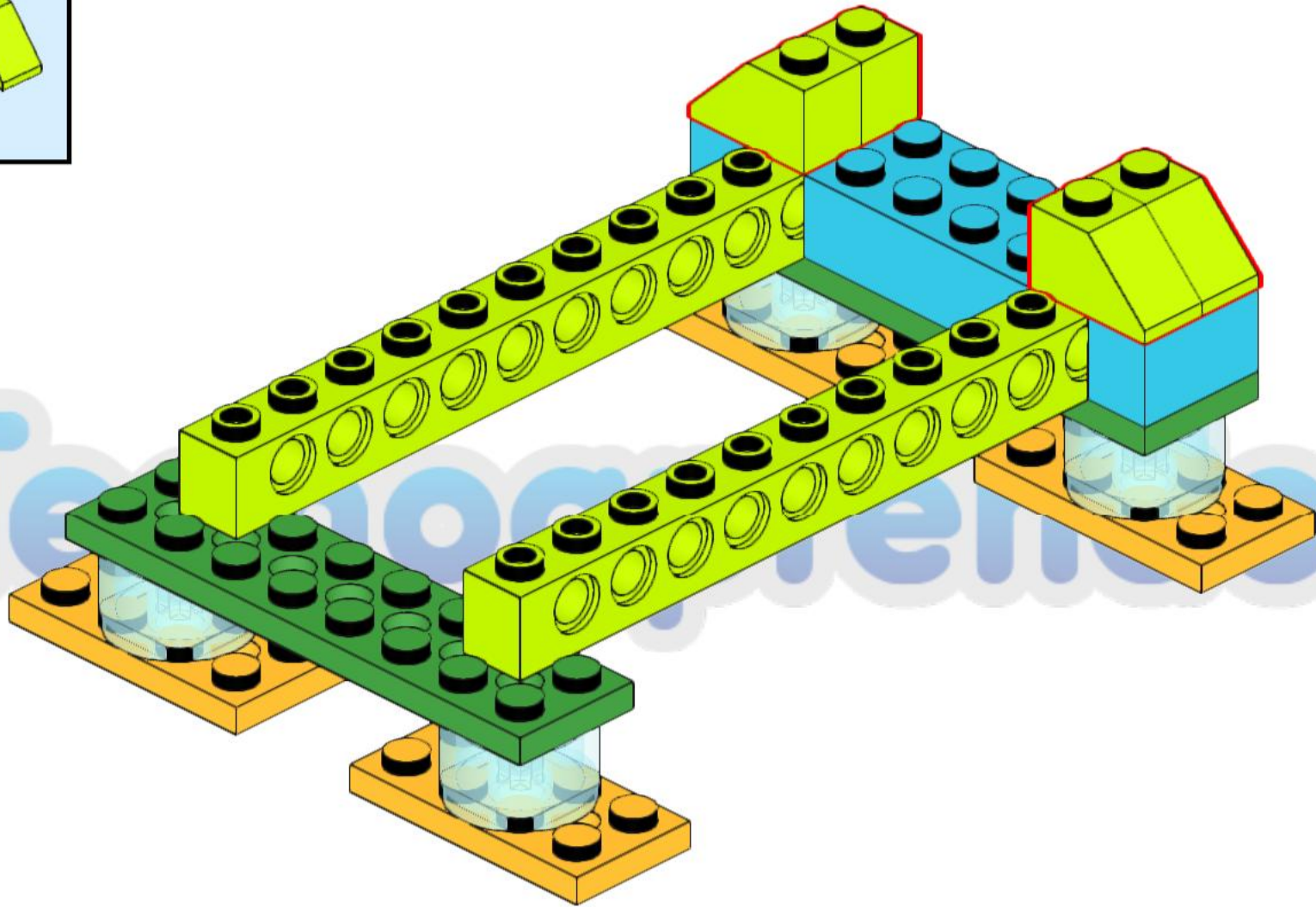
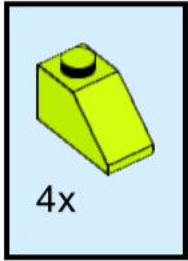

5

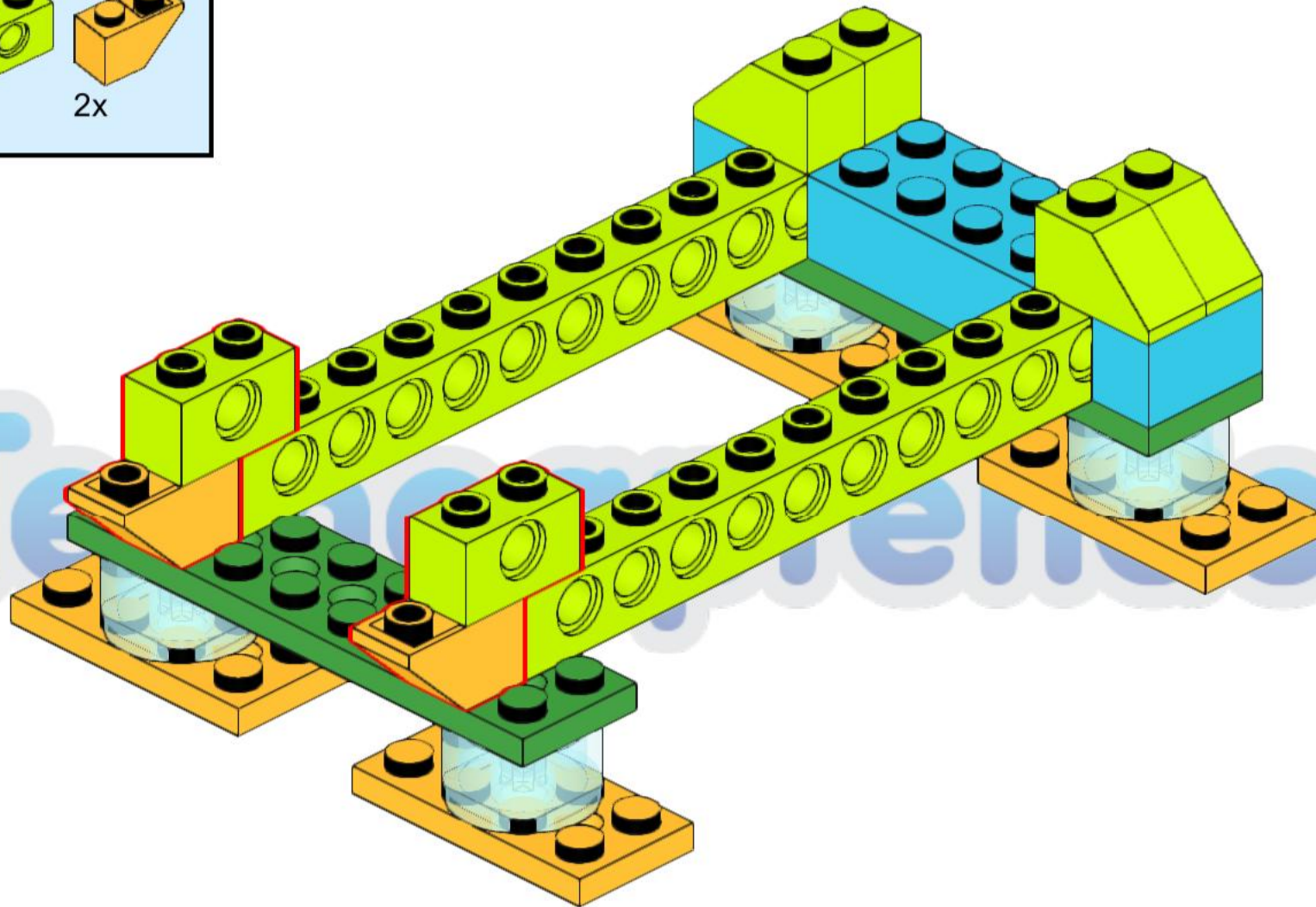
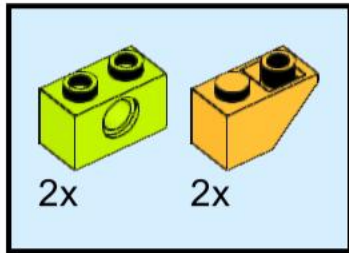



# 6

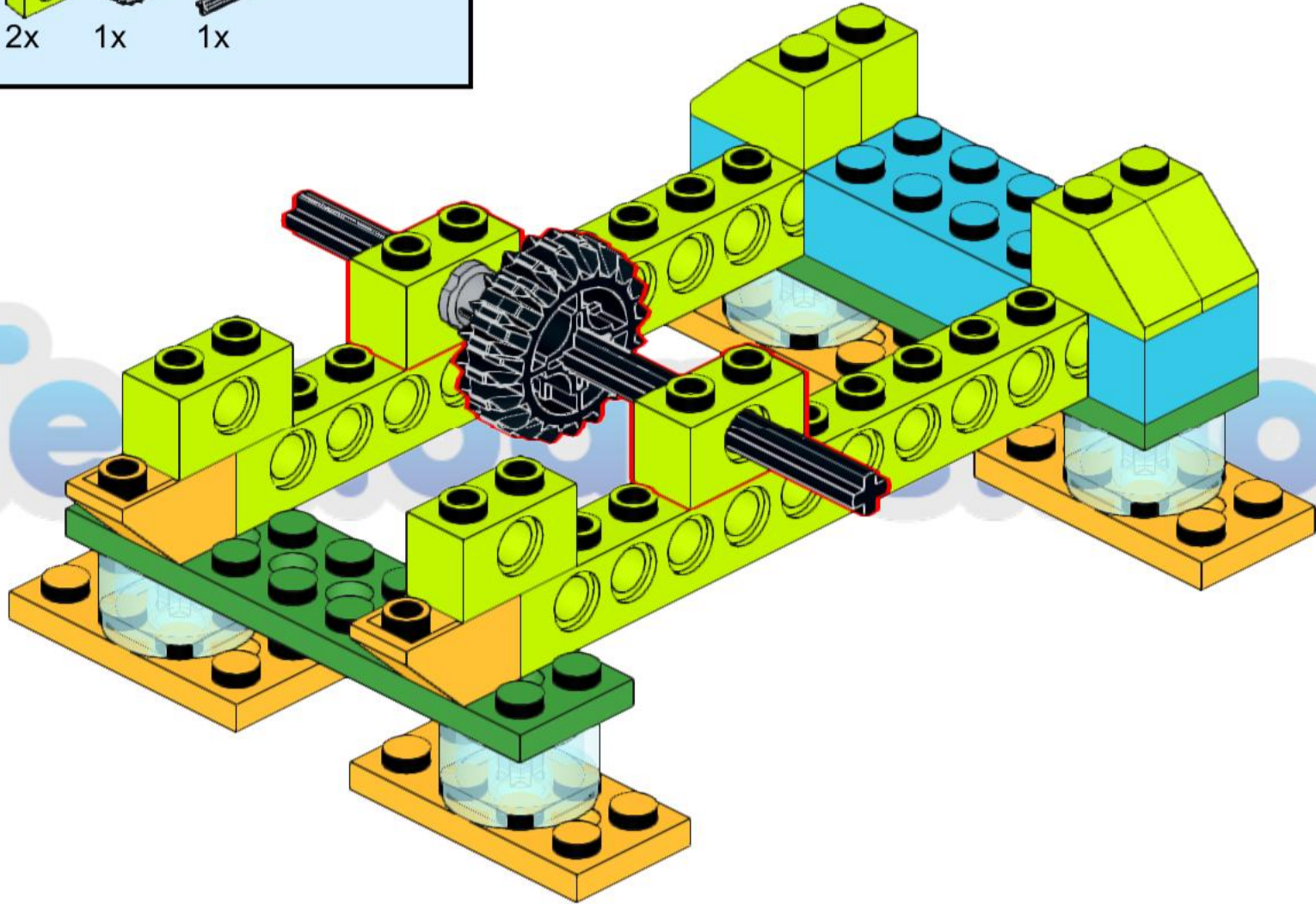
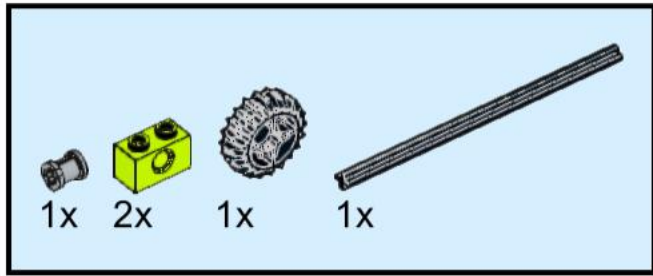

7

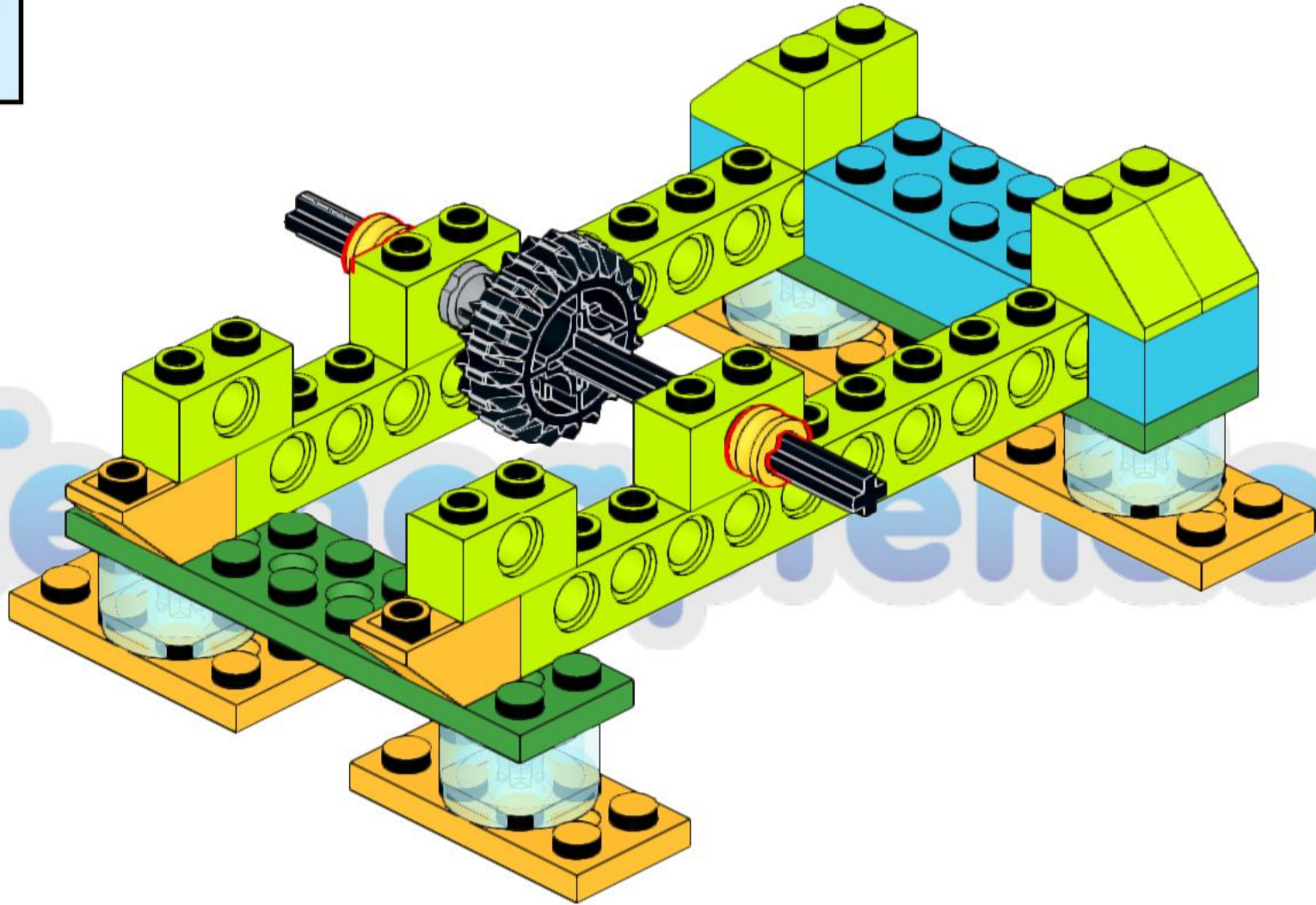



8

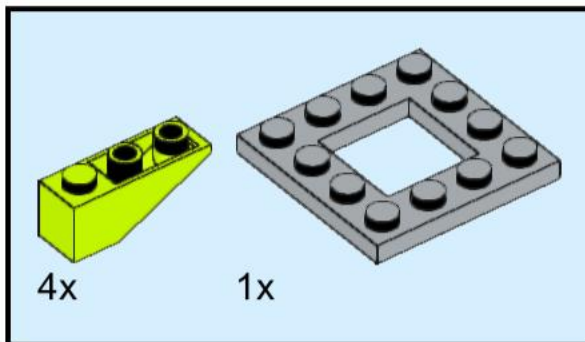
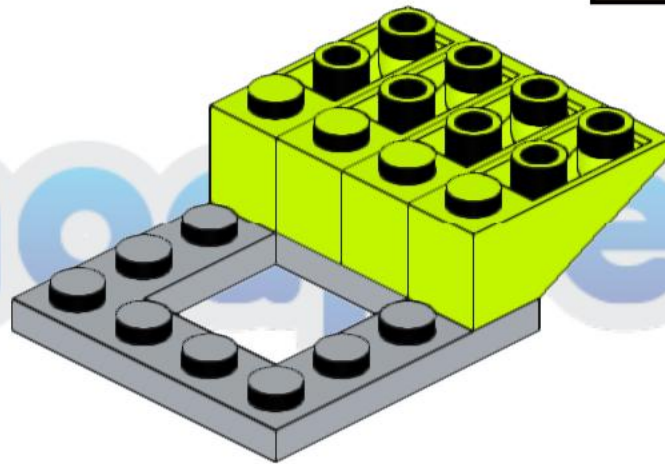
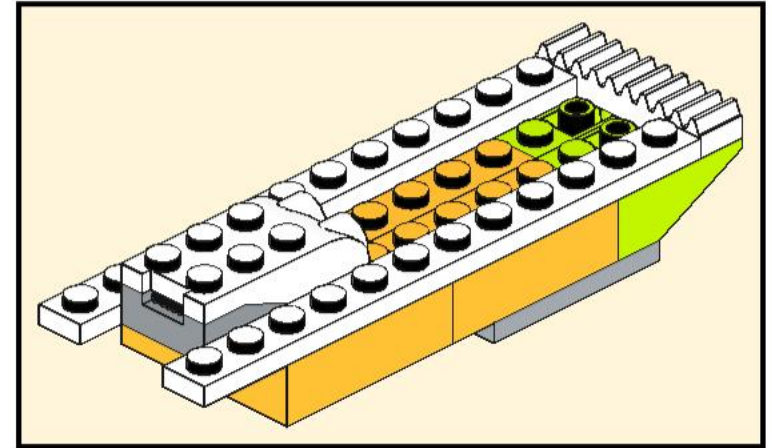

Tecnosendo

9

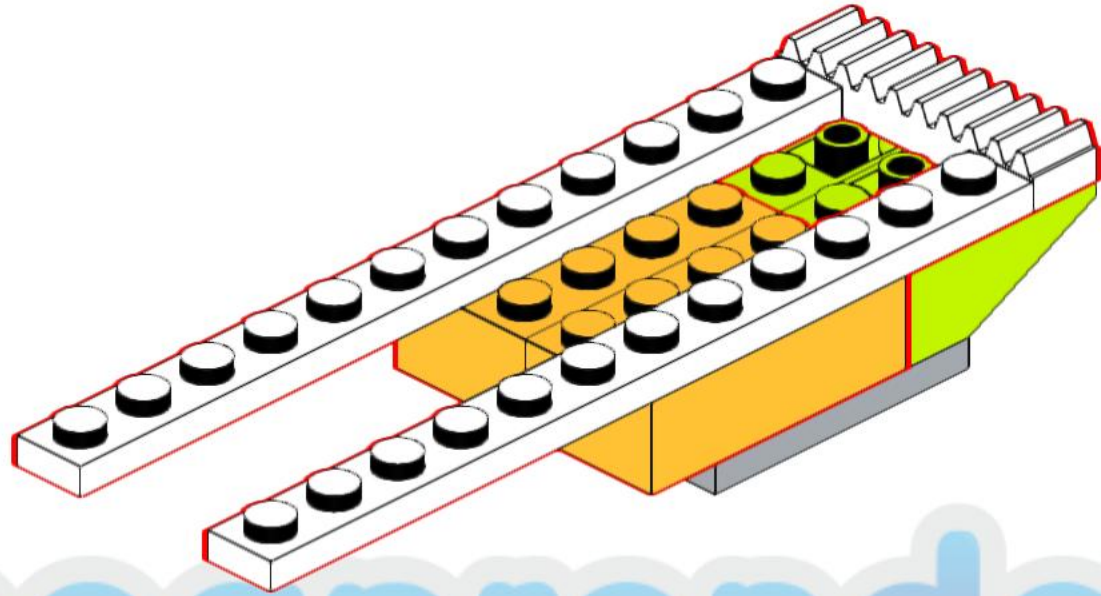
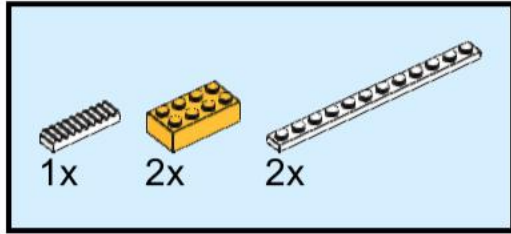

10

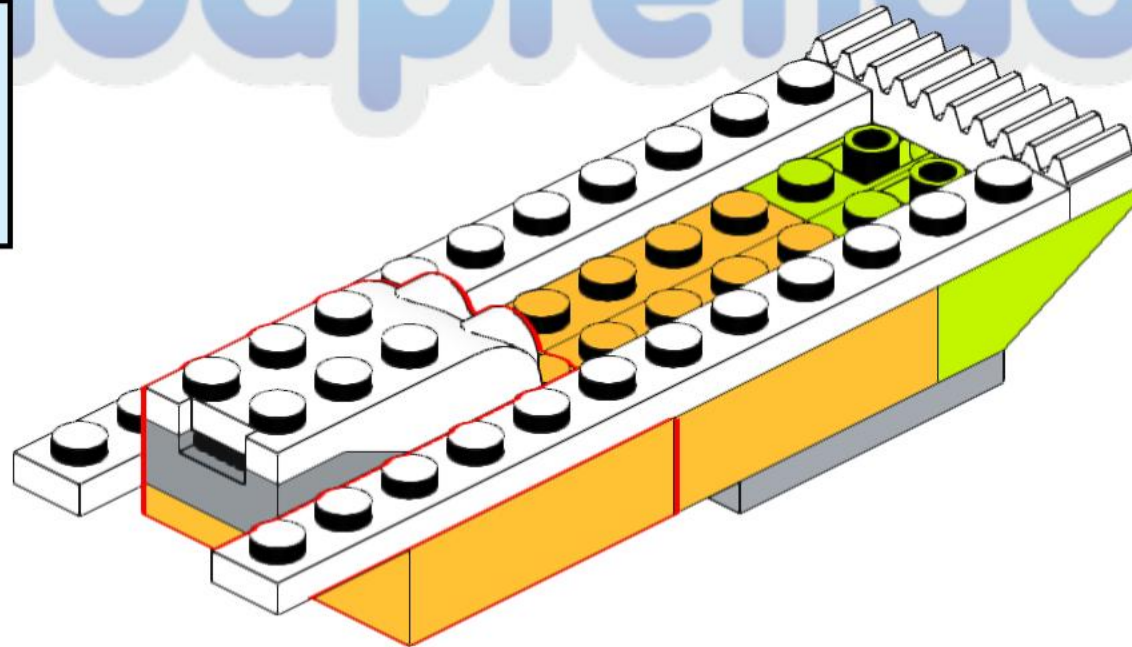
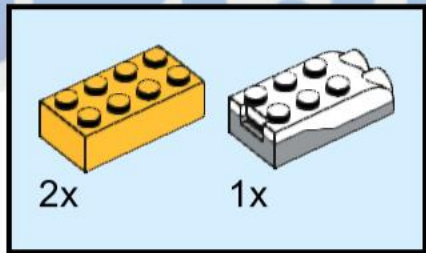

Tecnoaprendo

11

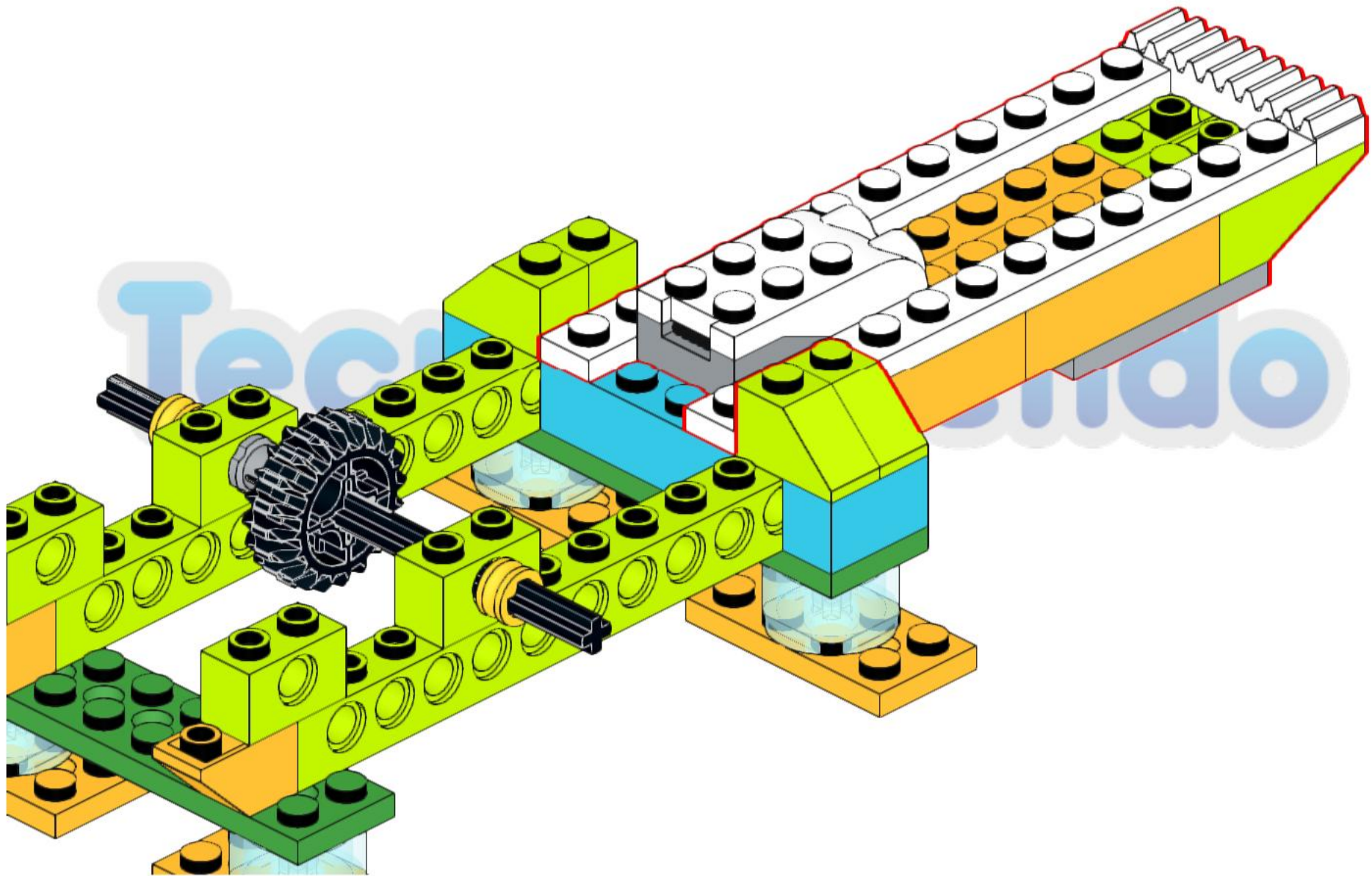



# 12

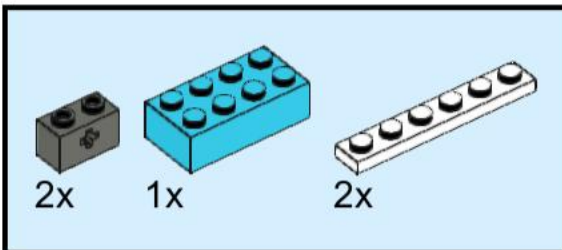
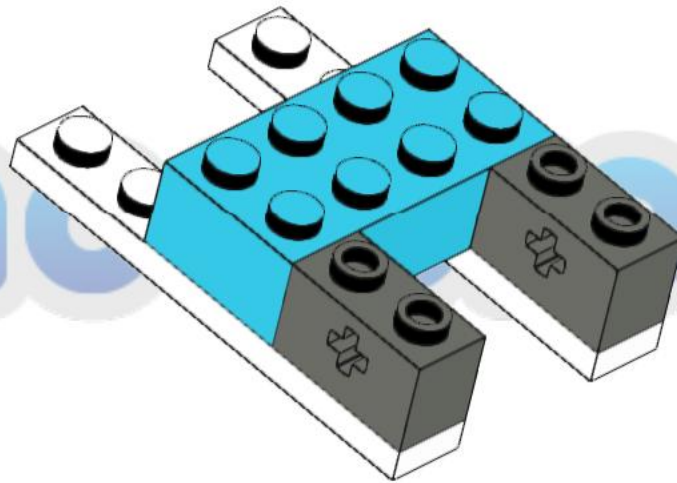
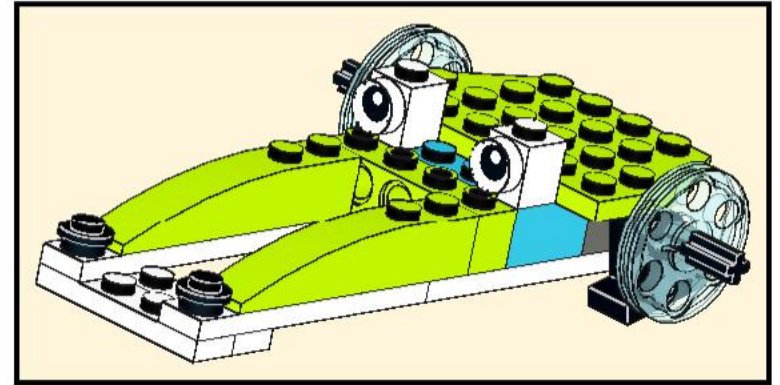

# 13

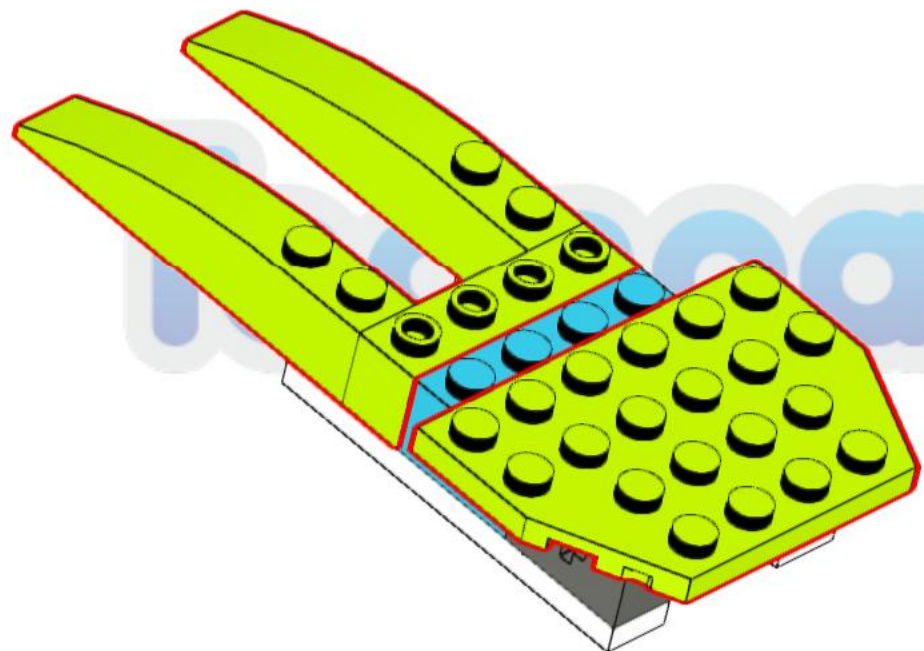
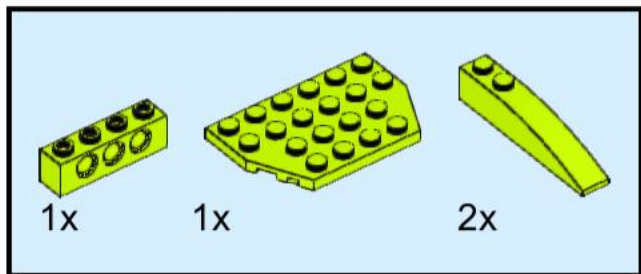

# 14

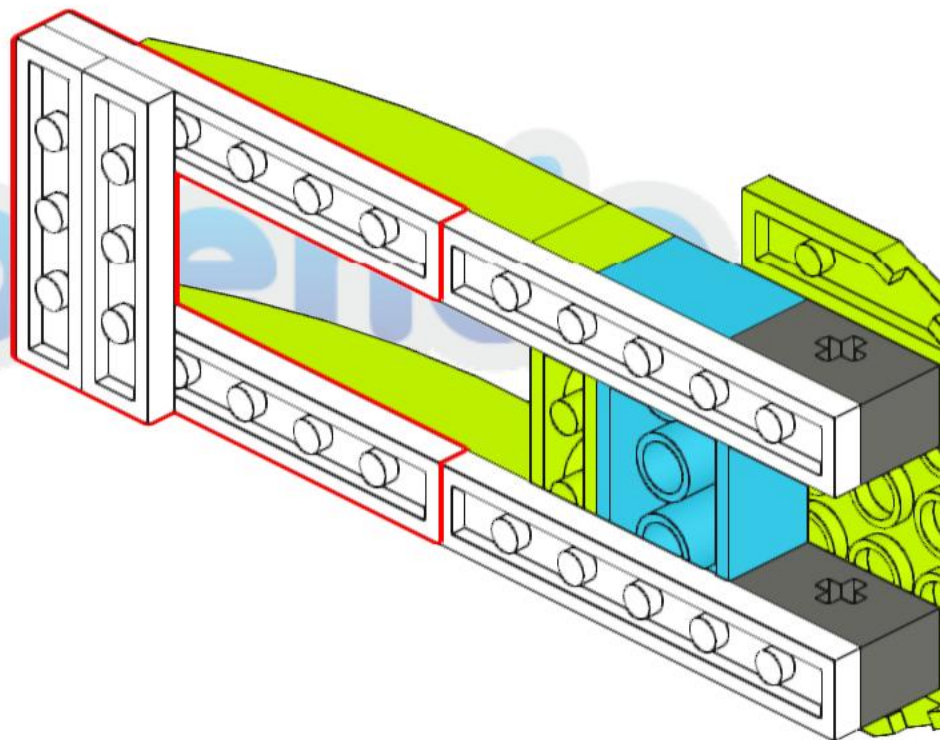
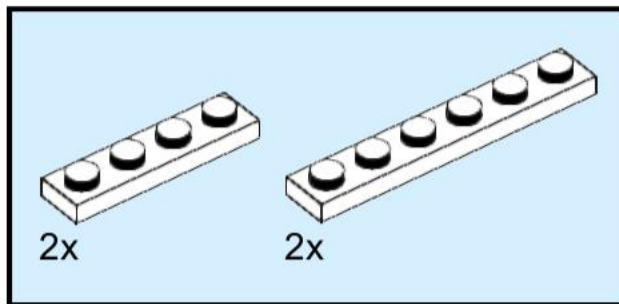

# 15

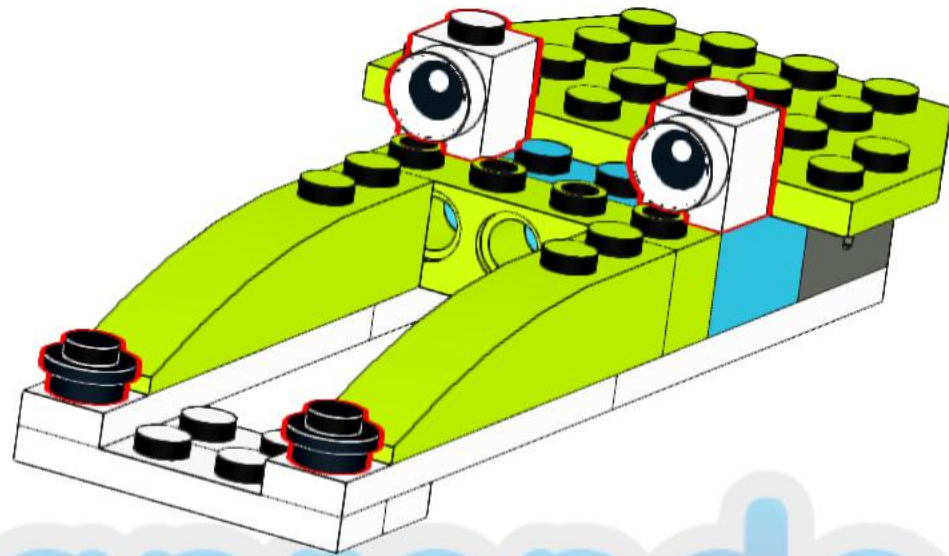
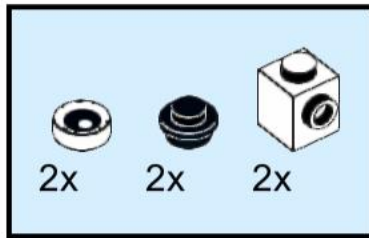

# 16

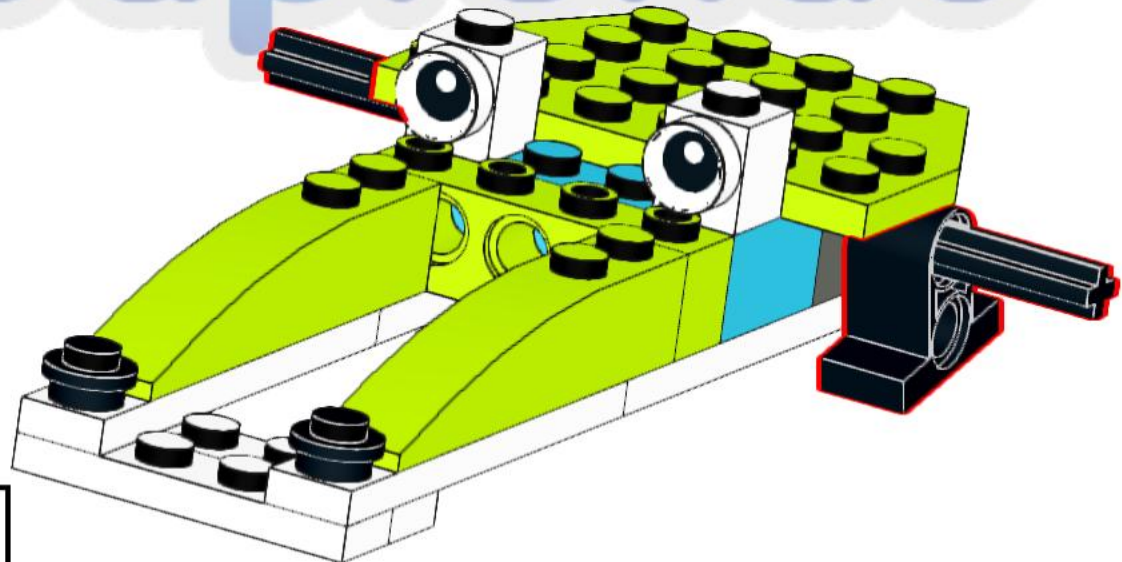
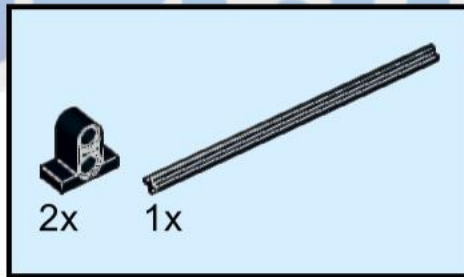

Tecnoaprendo



17

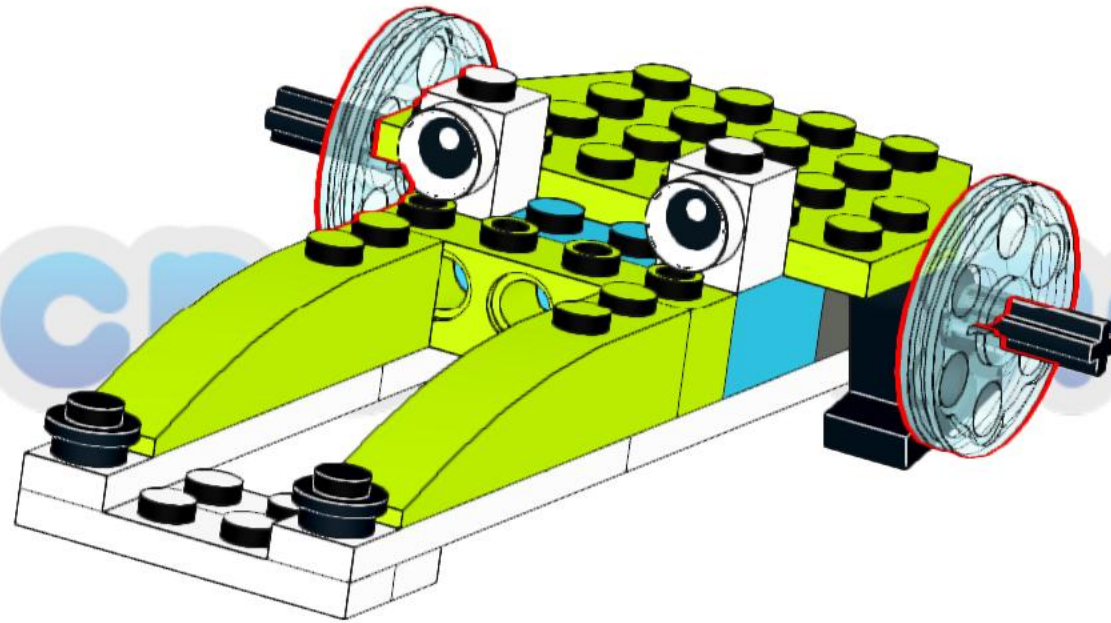
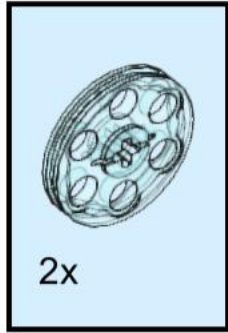

18

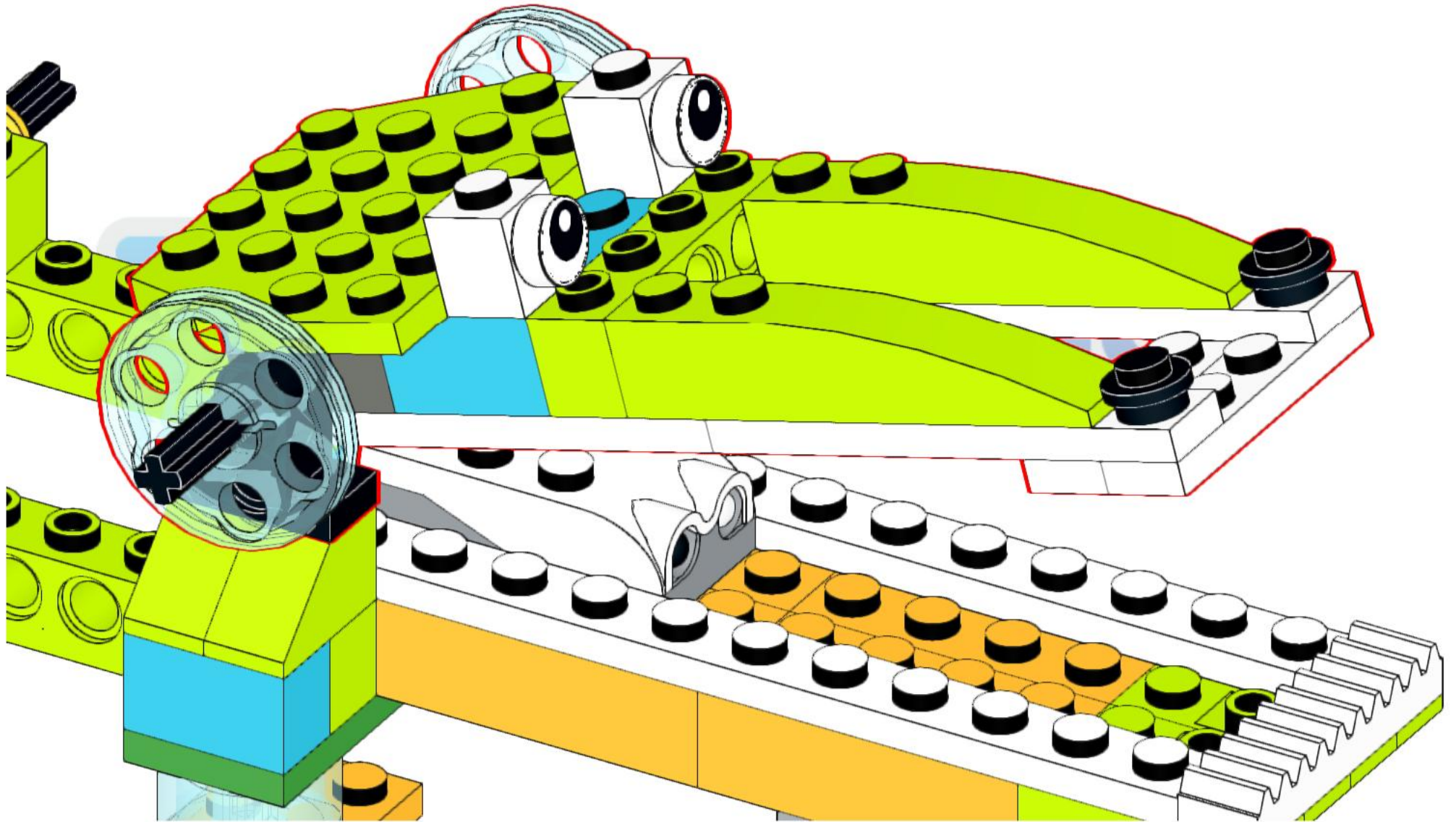

# 19

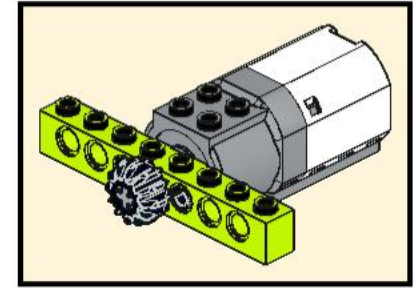
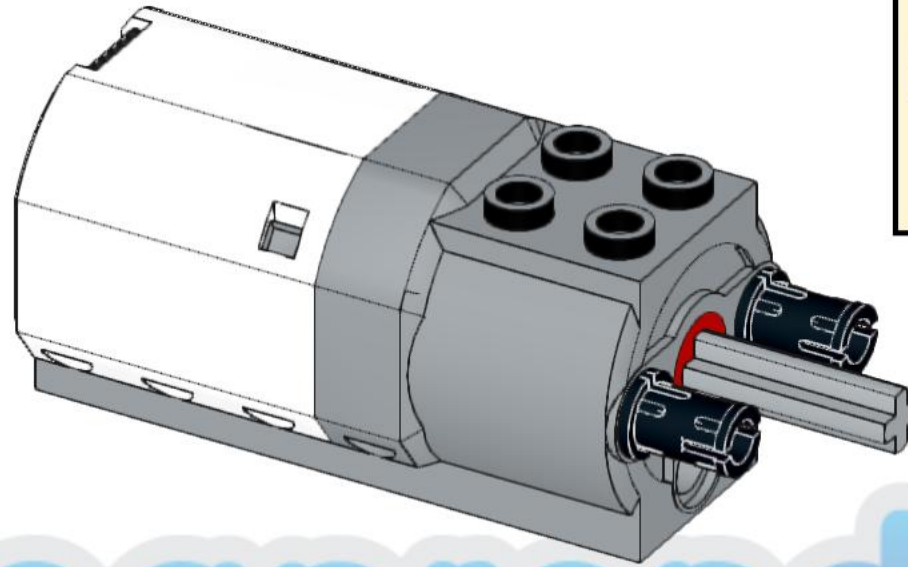
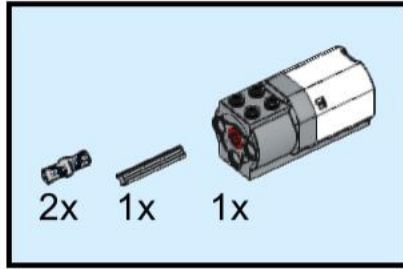

# 20

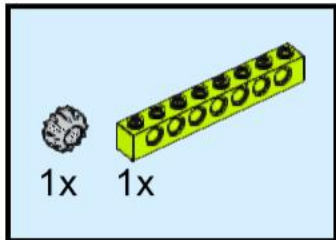
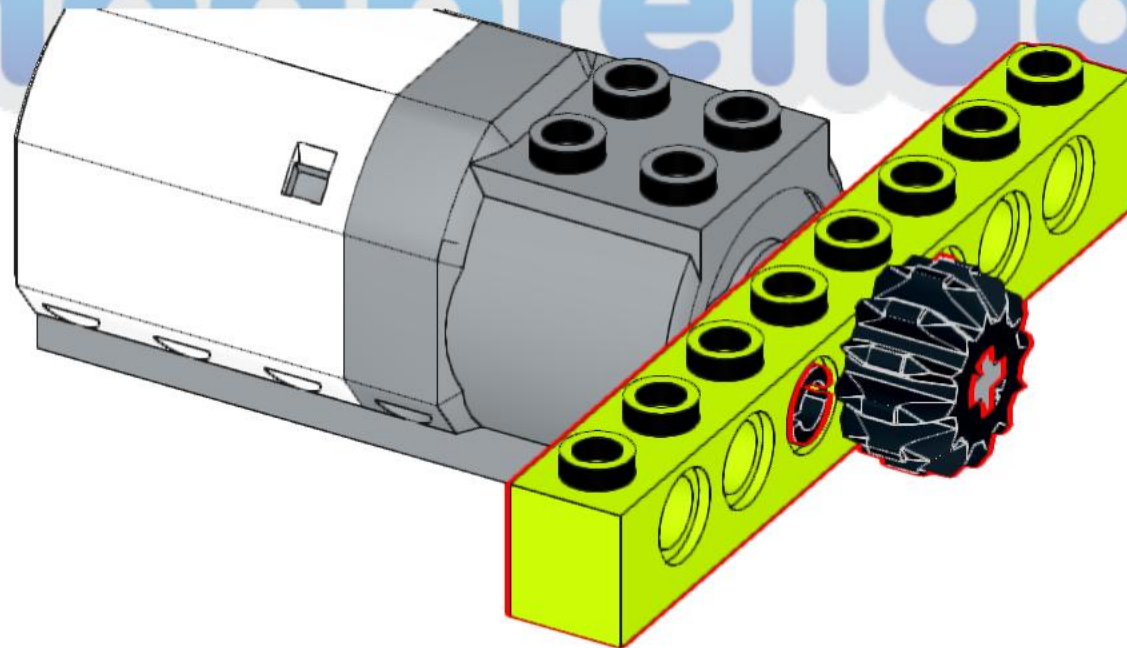

Tecnoprendo



21

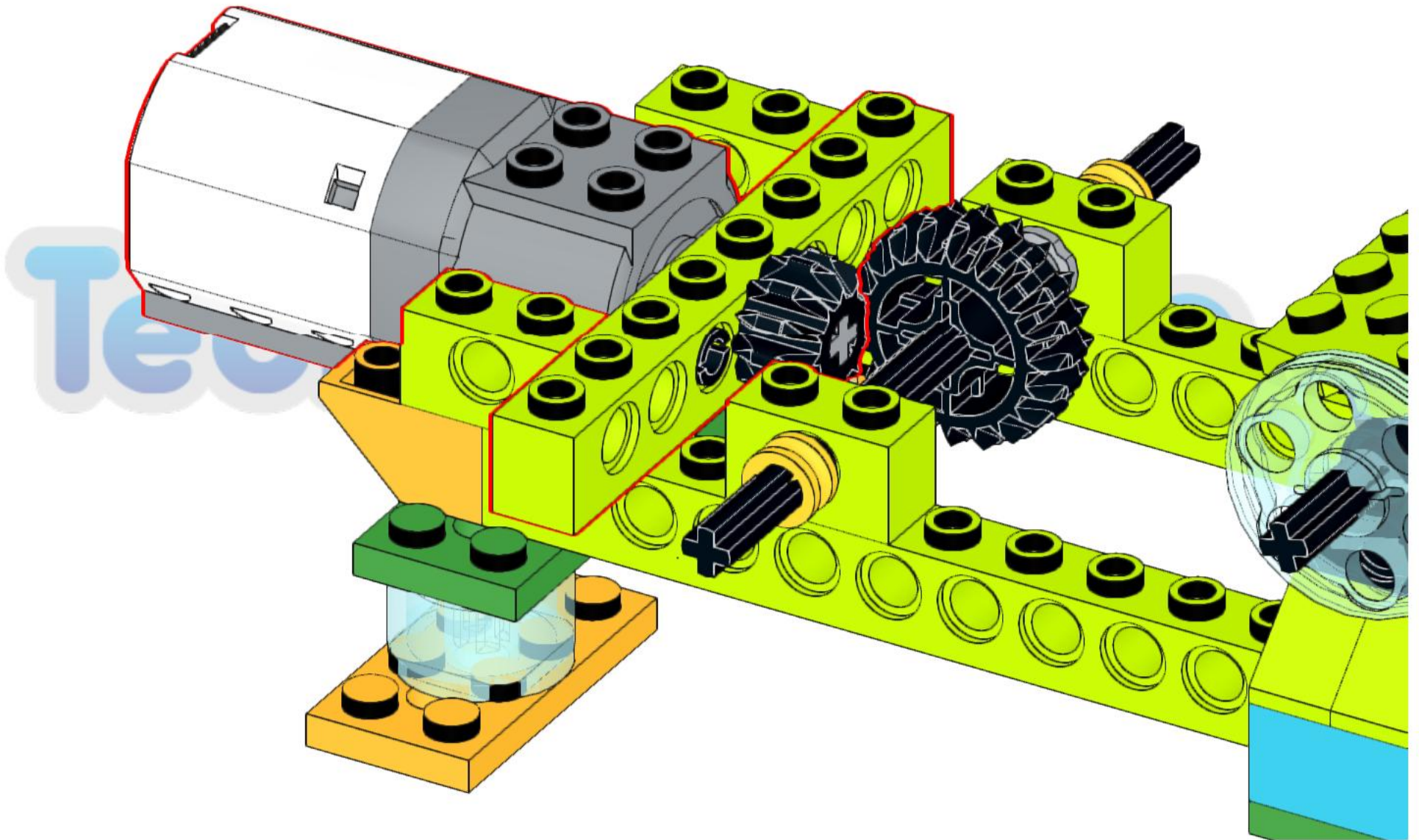

# 22

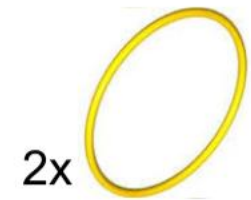

One rubber band in each side

One rubber band in each side

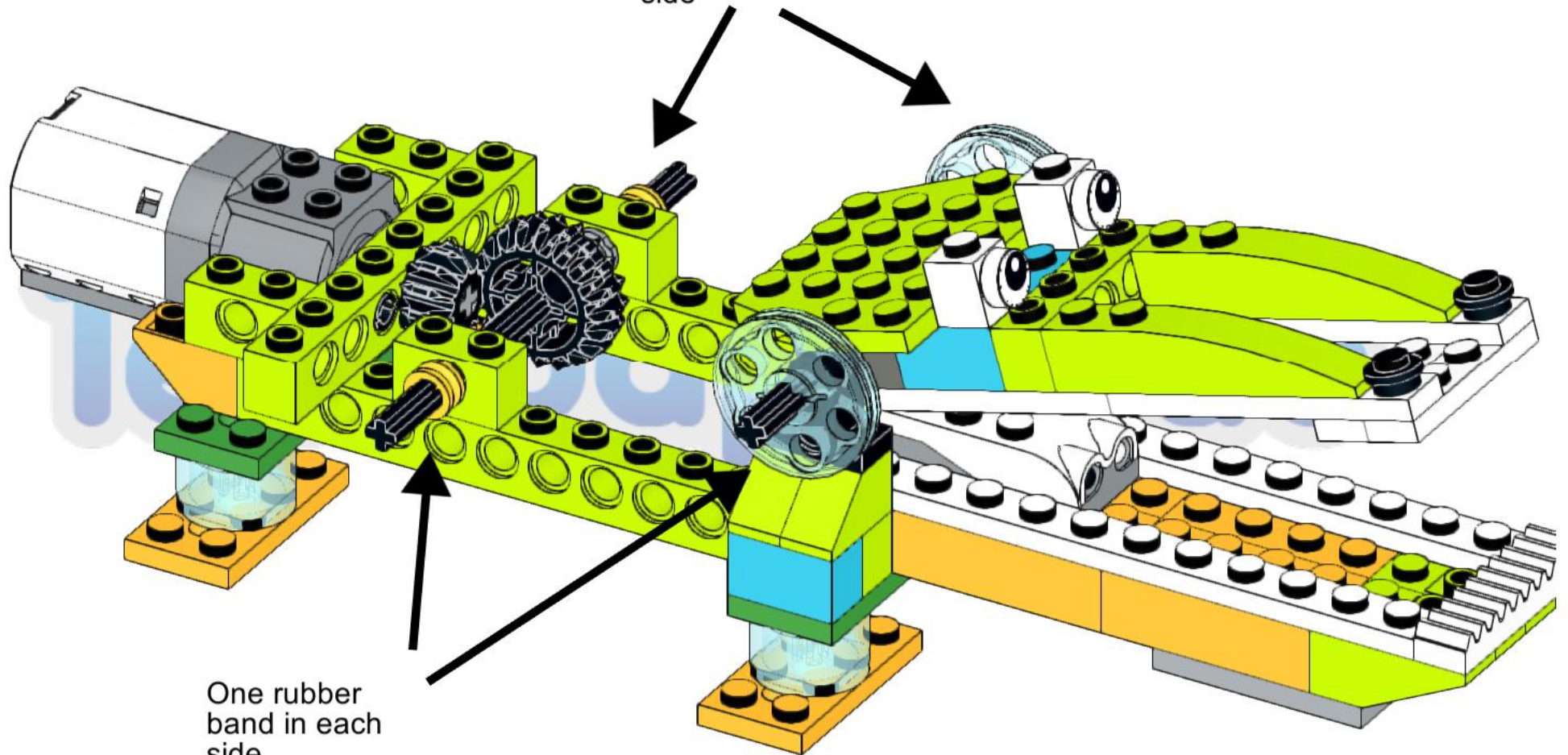



# 23

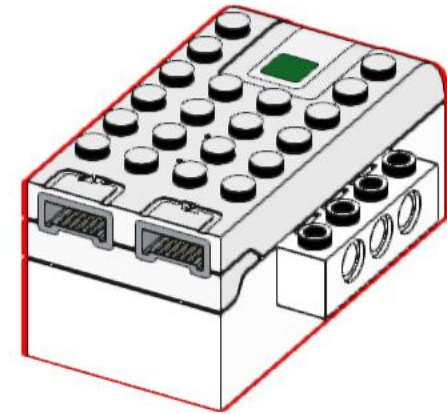
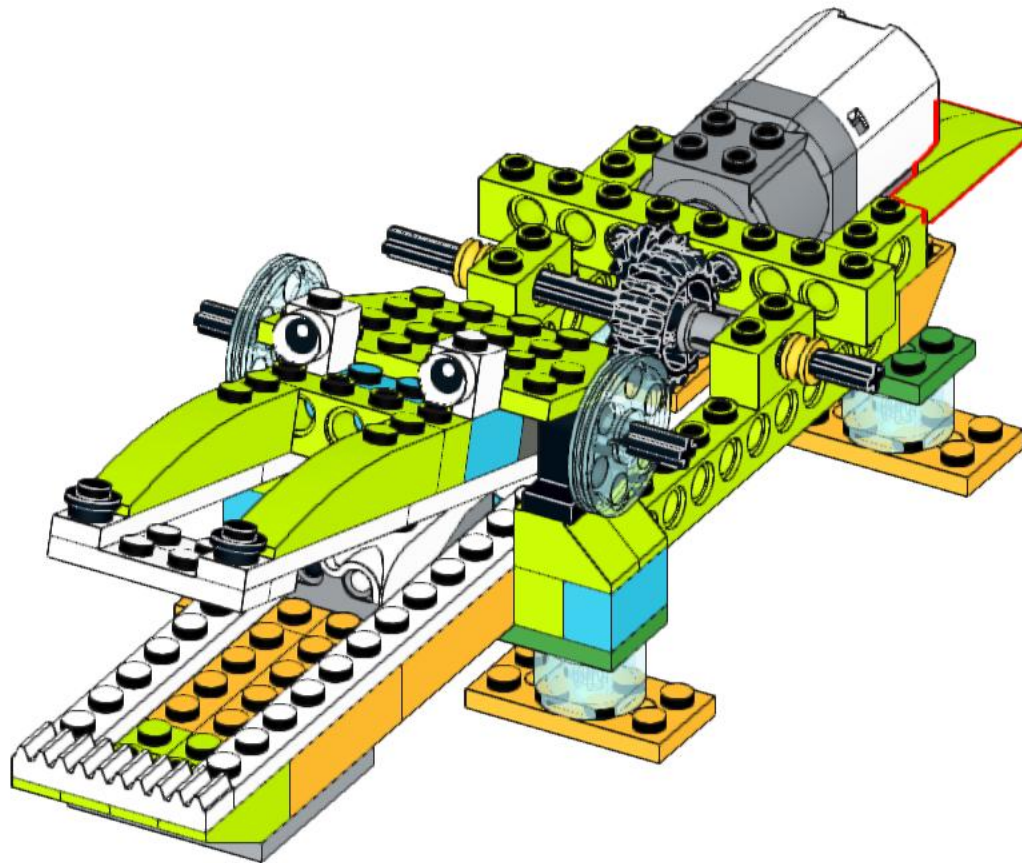
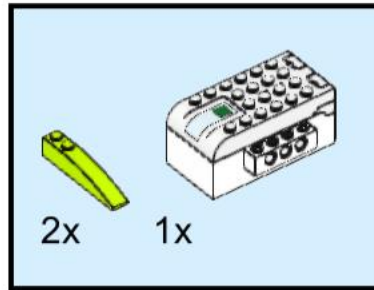



Nice job. It is time  
to code.



Program 1: Make the crocodile open and close the  
mouth.

Program 2: Make the crocodile snap its jaw shut,  
when you put a finger or Brick inside.

Sequence A: A grey brick icon labeled 'A' is followed by a green block containing a motor icon and a blue box with the number '4'. This is followed by a yellow bracket encompassing a green block with a motor icon and a circular arrow, a green block with a motor icon and an hourglass, a green block with a motor icon and a circular arrow, a green block with a motor icon and an hourglass, and a green block with a motor icon and a circular arrow. Below the last two green blocks are blue boxes containing the number '0.8'. The sequence ends with a yellow block containing a circular arrow icon.

# Tecnoaprendo

Sequence B: A grey brick icon labeled 'B' is followed by a green block with a motor icon and a blue box with '10'. This is followed by a yellow block with an hourglass icon and a small orange block with a brick icon and arrows. This is followed by a green block with a motor icon and a circular arrow, and a green block with a motor icon and an hourglass and a blue box with '1'.

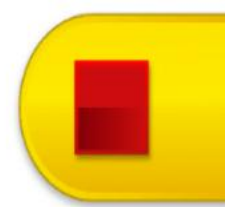

2x  
4073, 11

2x  
2780, 11

1x  
32270, 11

2x  
32530, 11

1x  
32269, 11

2x  
3737, 11

2x  
32064, 85

1x  
3713, 86

1x  
4519, 86

1x  
64799, 86

2x  
98138pb007, 1

2x  
87087, 1

2x  
3710, 1

1x  
3743, 1

1x  
20844, 1

4x  
3666, 1

1x  
21980, 1

1x  
19071c01, 1

2x  
60479, 1

2x  
3665, 110

4x  
3709b, 110

4x  
3001, 110

2x  
4265c, 3

4x  
3700, 34

4x  
3040, 34

4x  
4287, 34

1x  
3701, 34

4x  
42022, 34

1x  
32059, 34

1x  
3702, 34

2x  
3895, 34

2x  
3738, 36

2x  
3004, 156

2x  
3001, 156

4x  
3941, 15

2x  
4185, 15