



# Build the robot!

**ROBORISE-IT!**  
ROBOTIC EDUCATION



0



28



nerrka@gmail.com

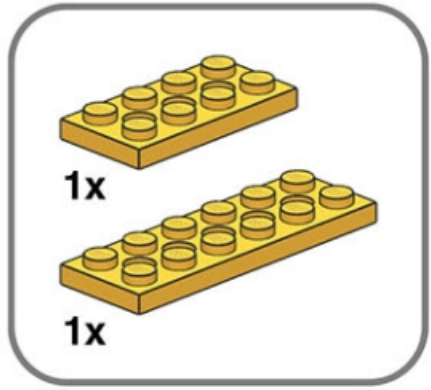

**1**

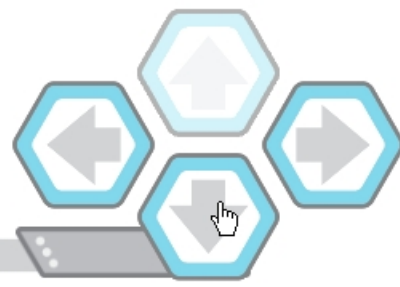
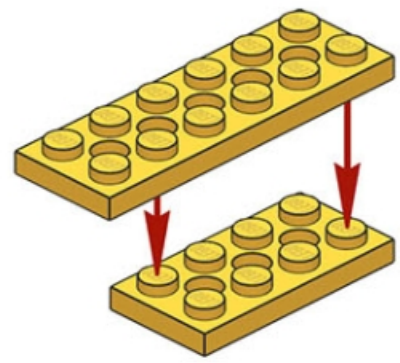

nerrka@gmail.com

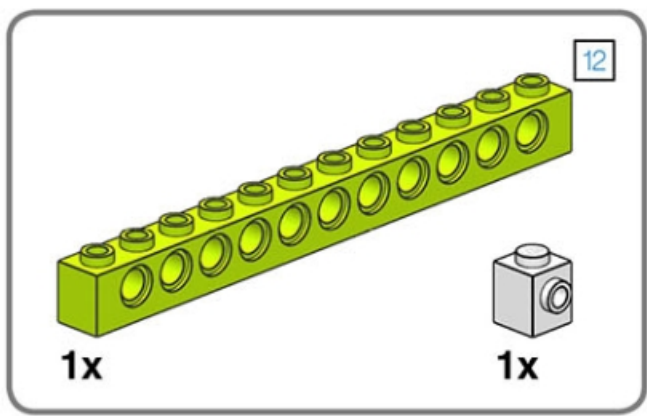

**2**

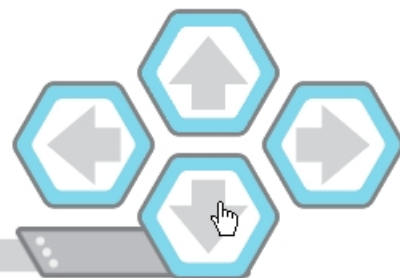
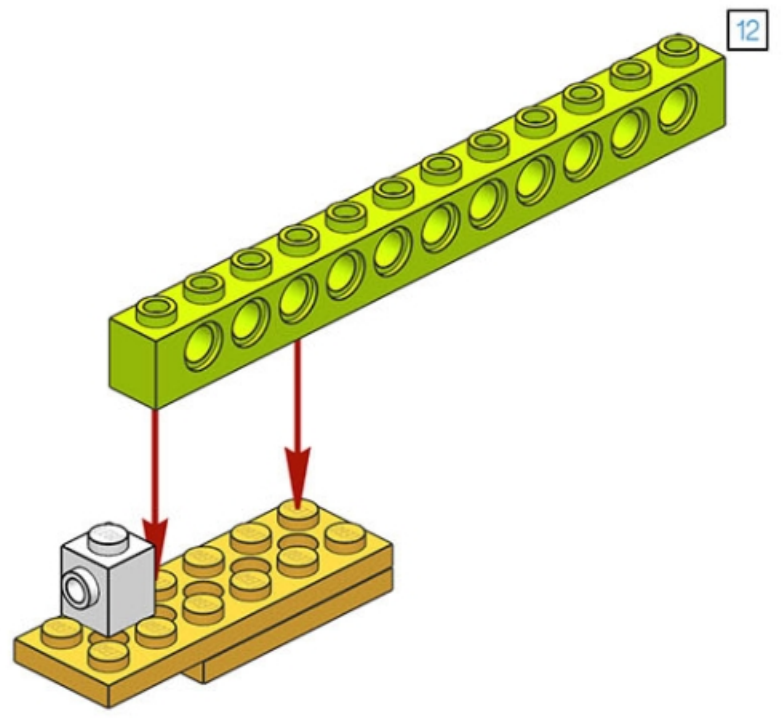

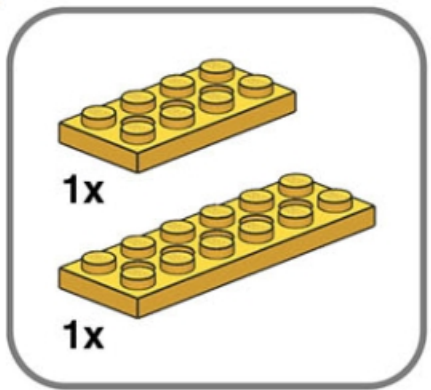

1

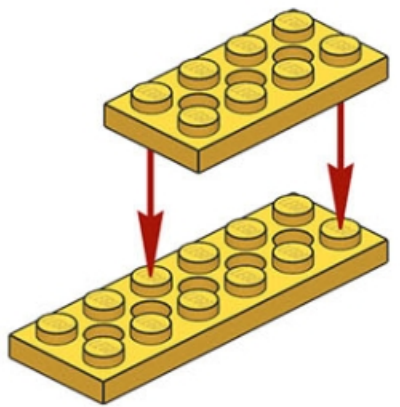

2

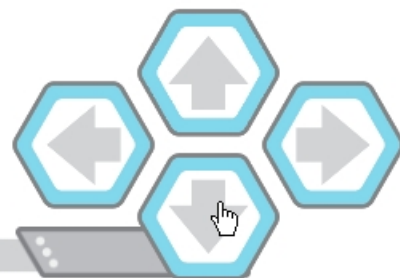
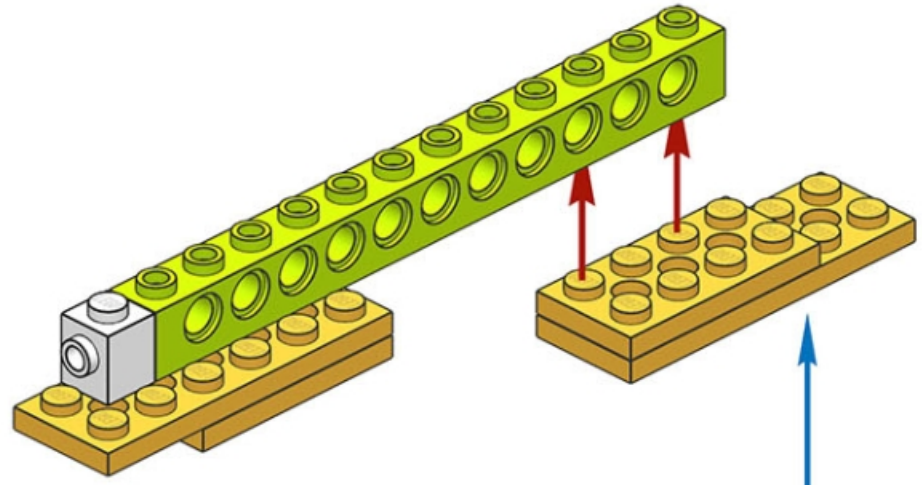
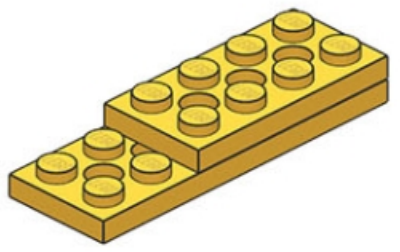

nerrka@gmail.com

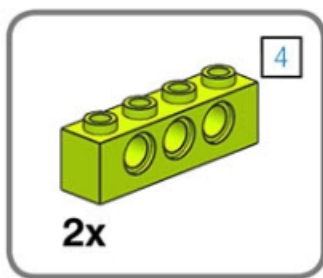

**4**

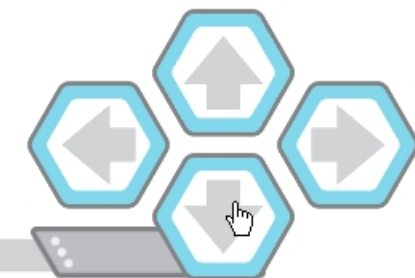
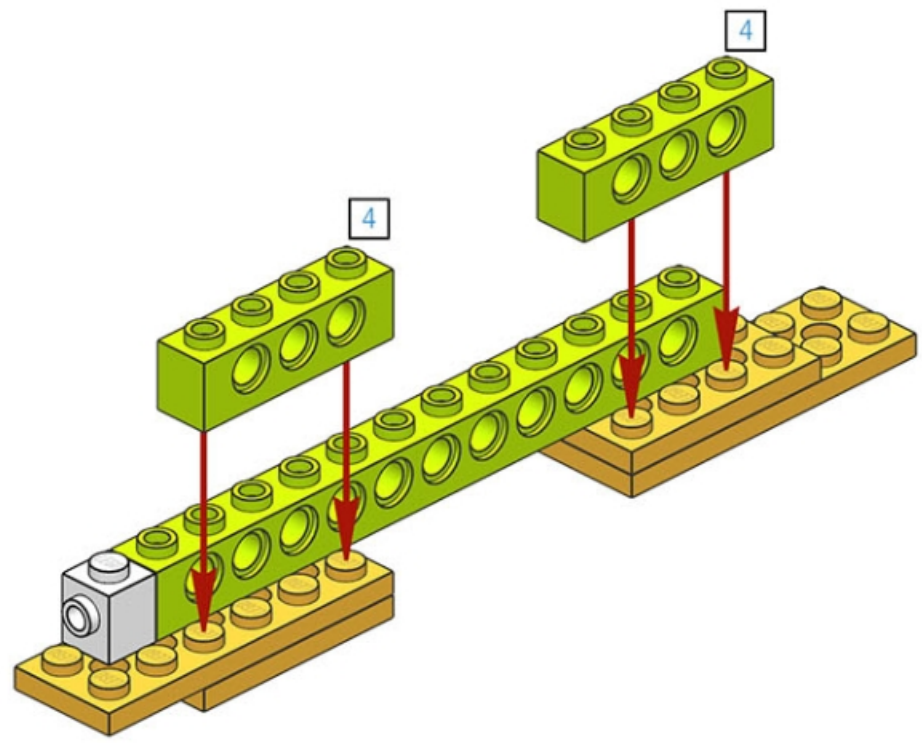

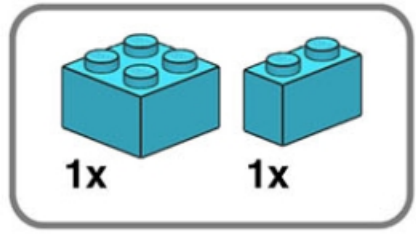

**5**

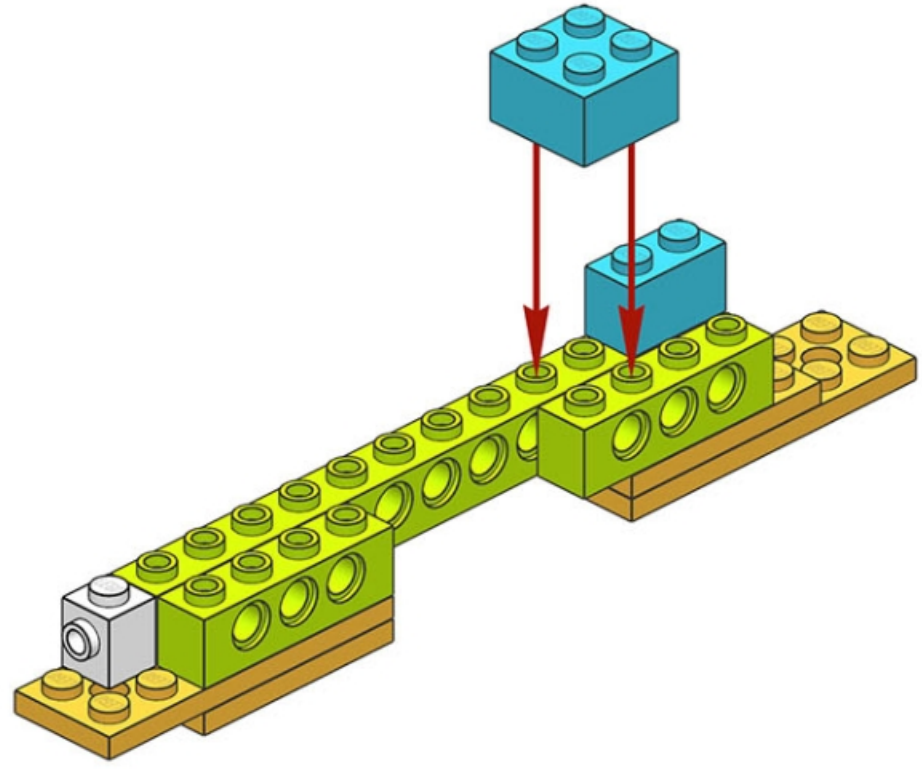

nerrka@gmail.com

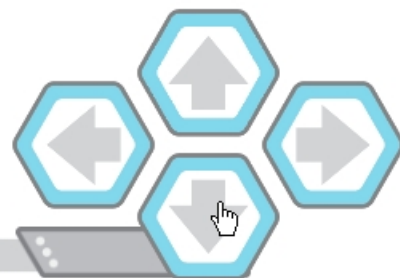

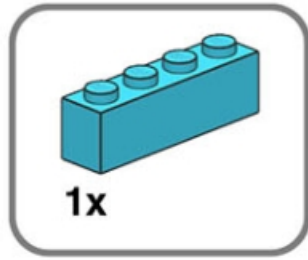

**6**

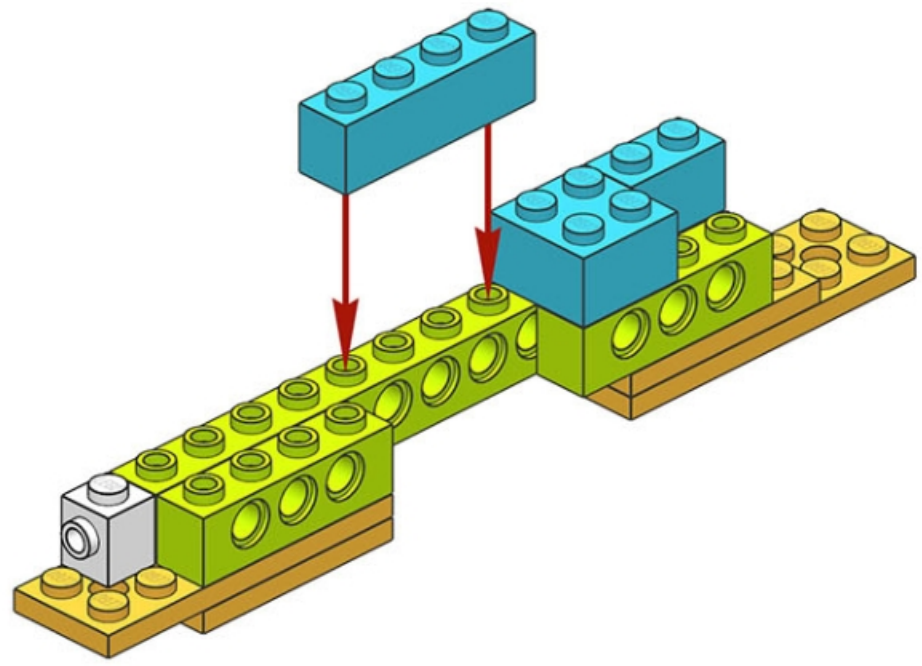

nerrka@gmail.com

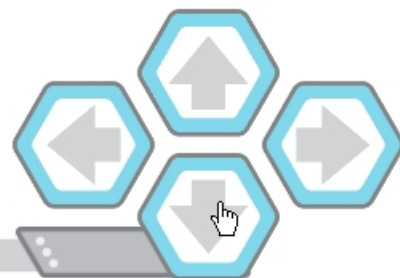

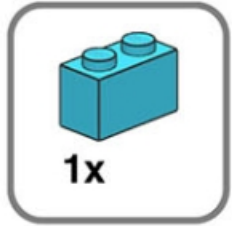

**7**

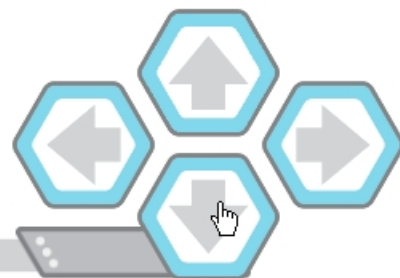
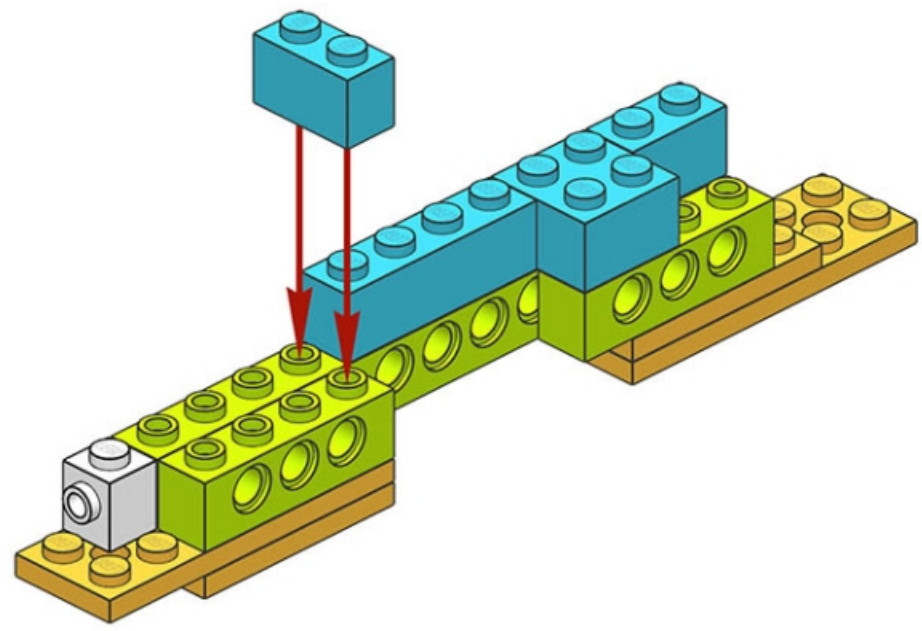

S



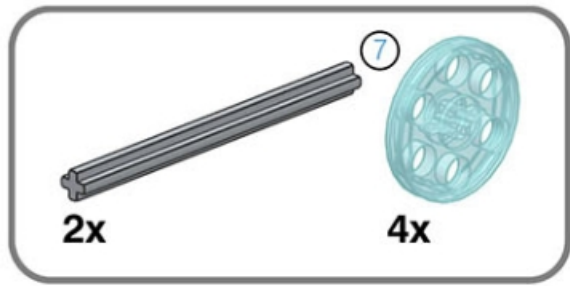

8

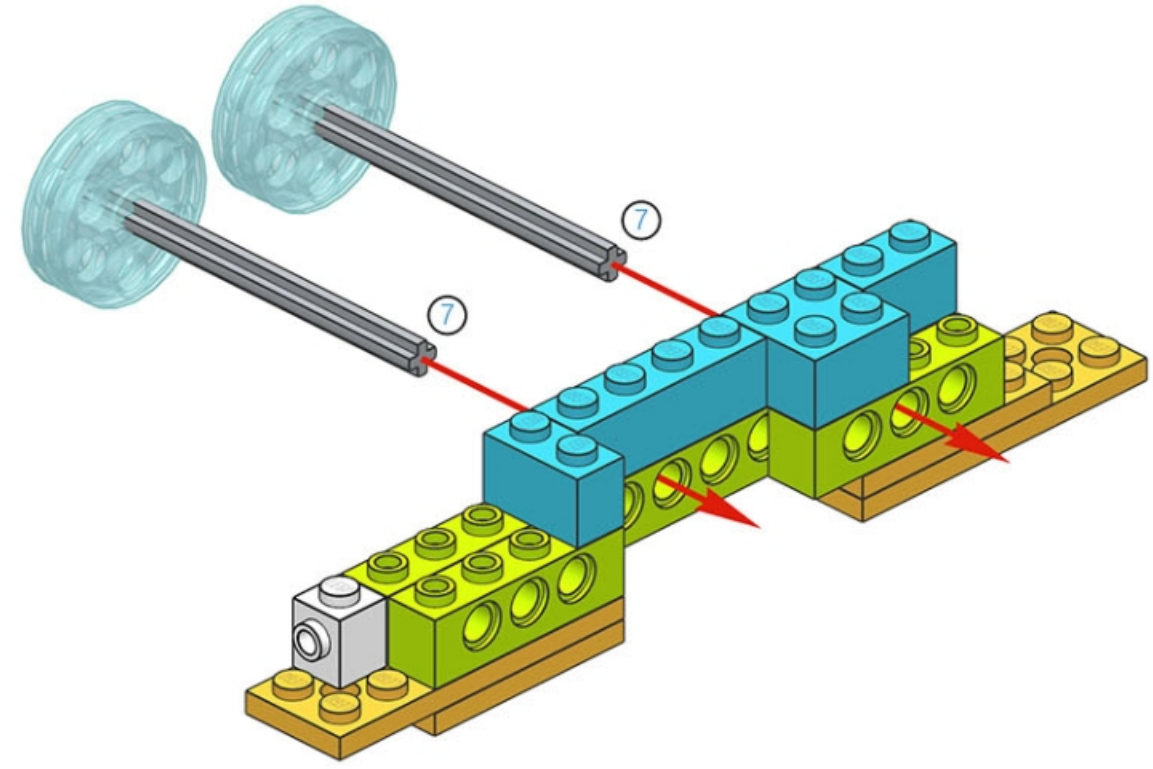

nerka@gmail.com





9

nerrka@gmail.com

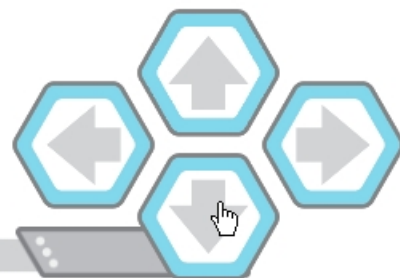
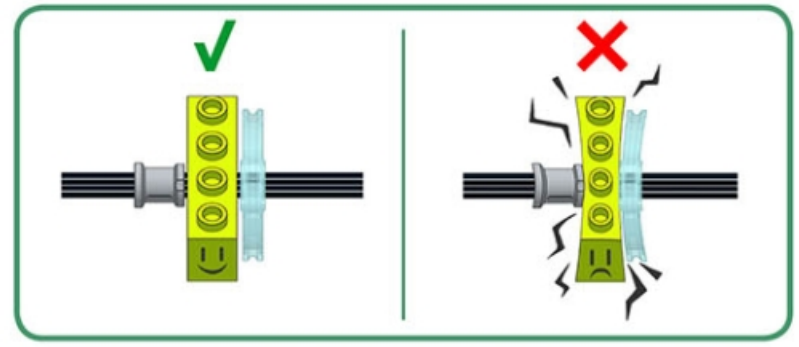
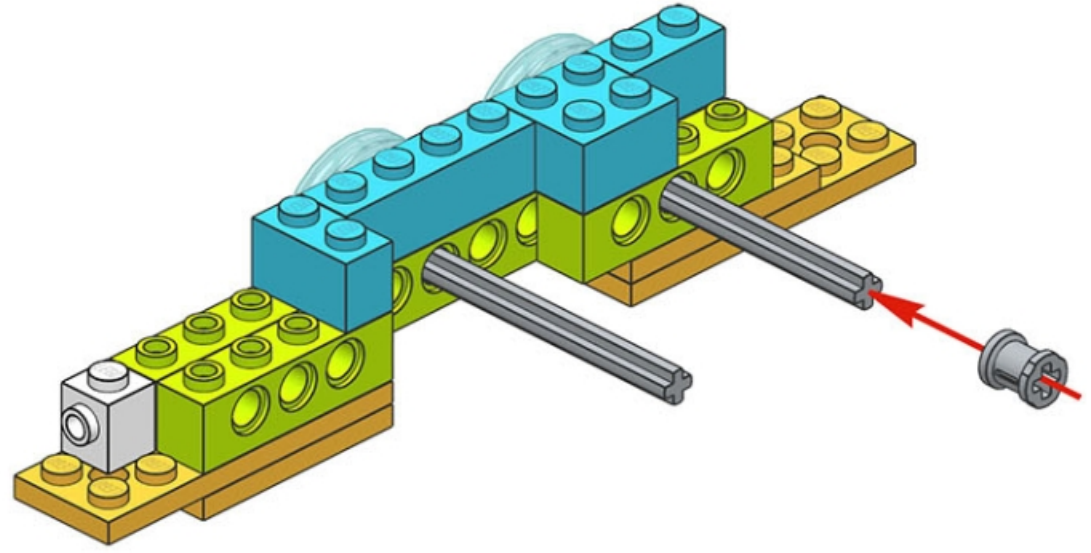



**10**

nerka@gmail.com

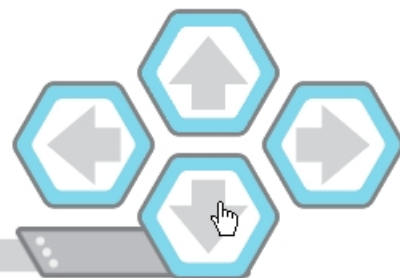
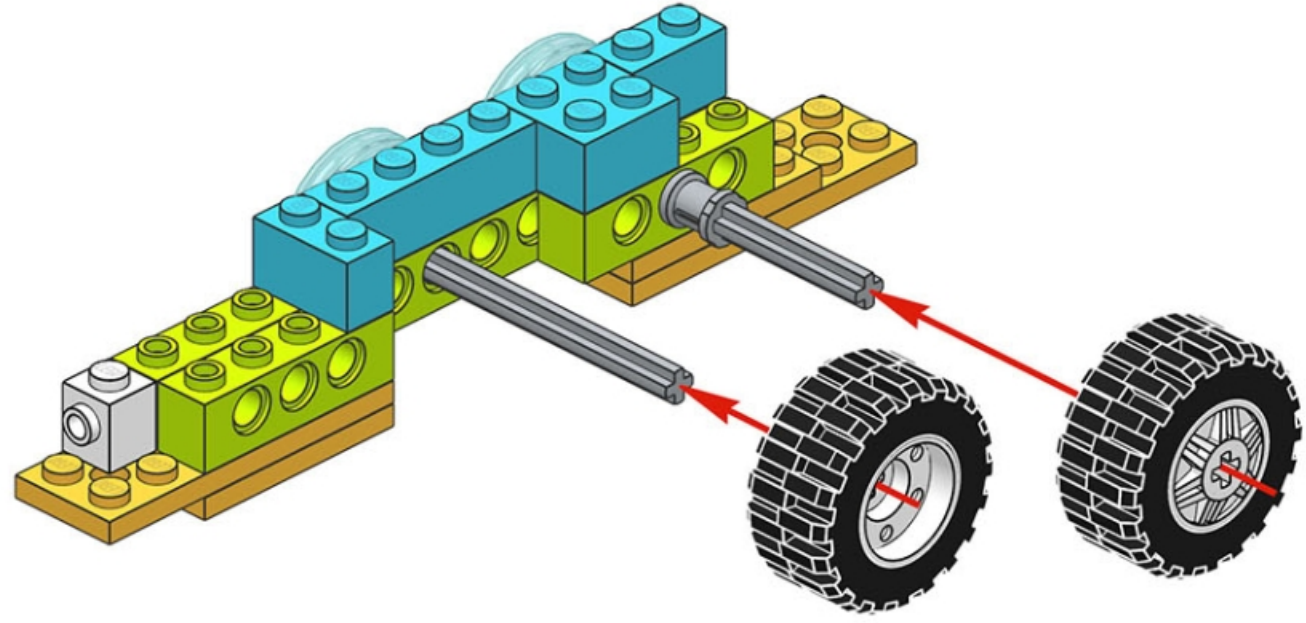

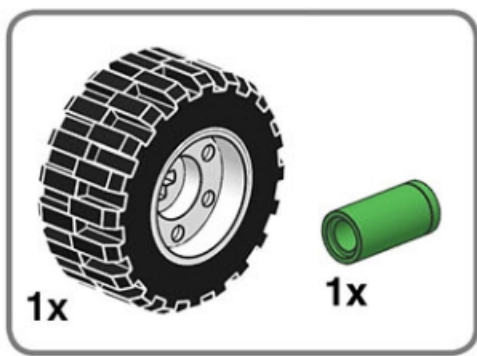

# 11

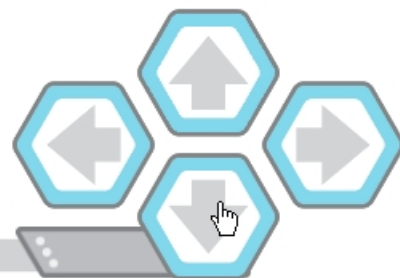
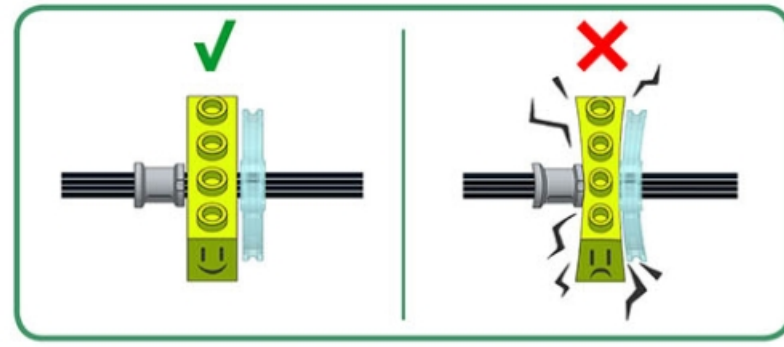
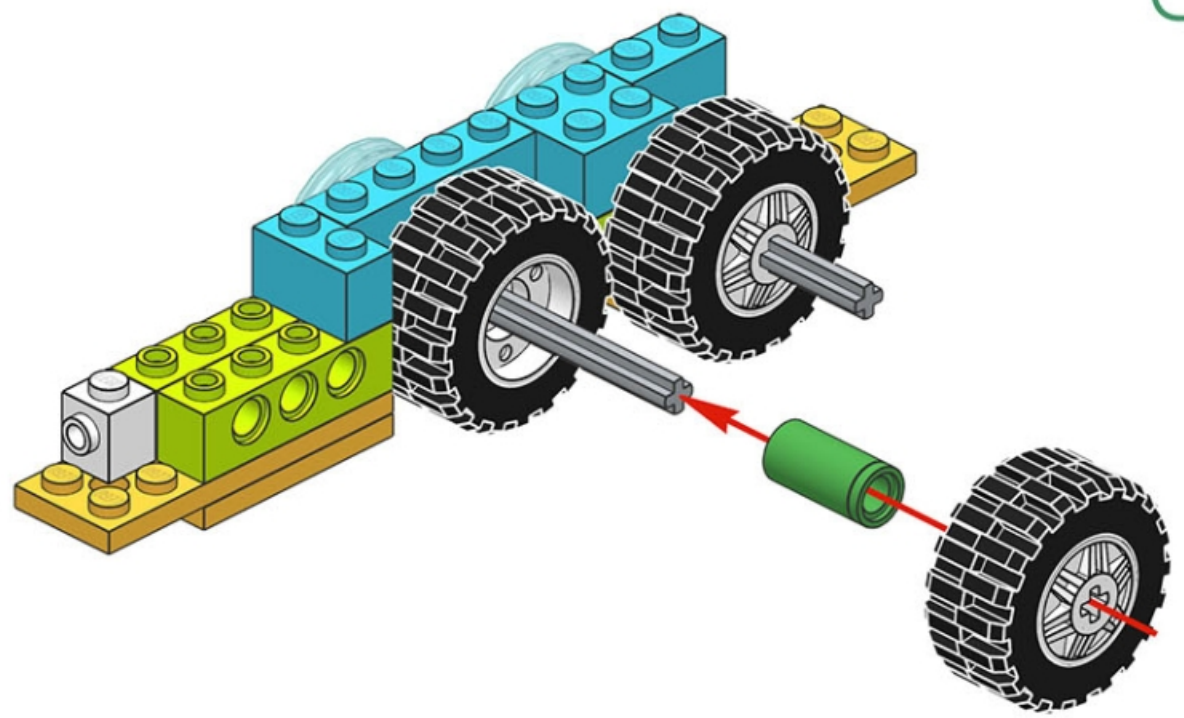

nerka@gmail.com

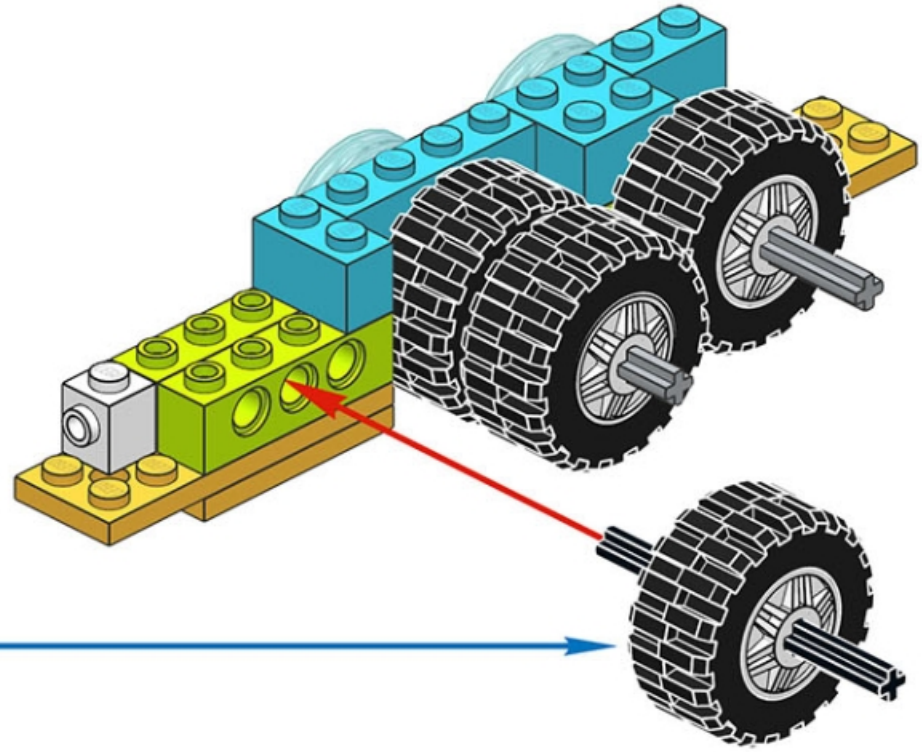
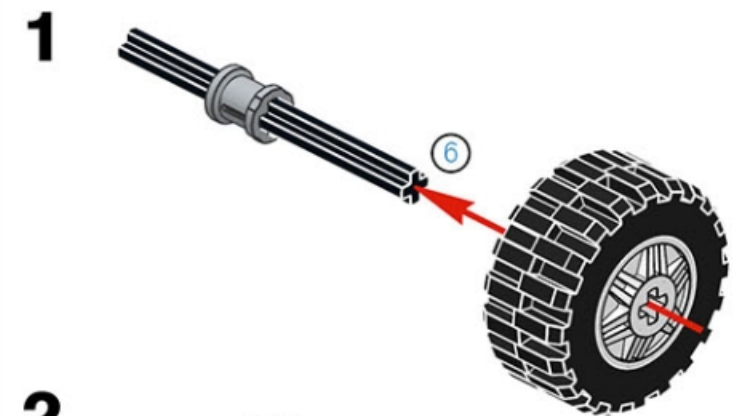
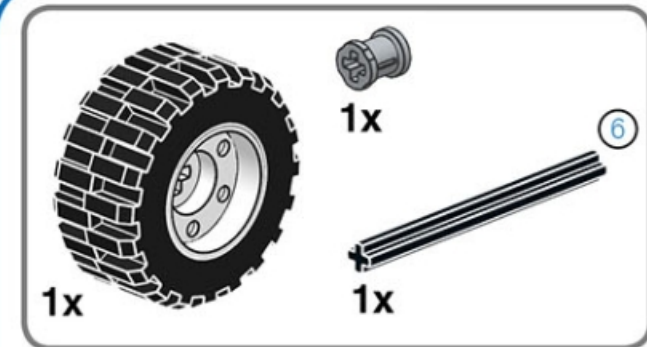

12/56

0

40

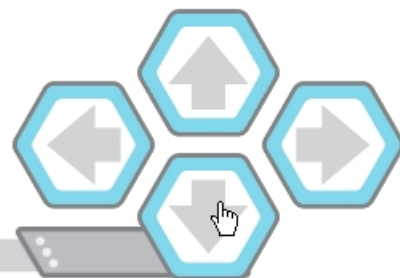

# 13

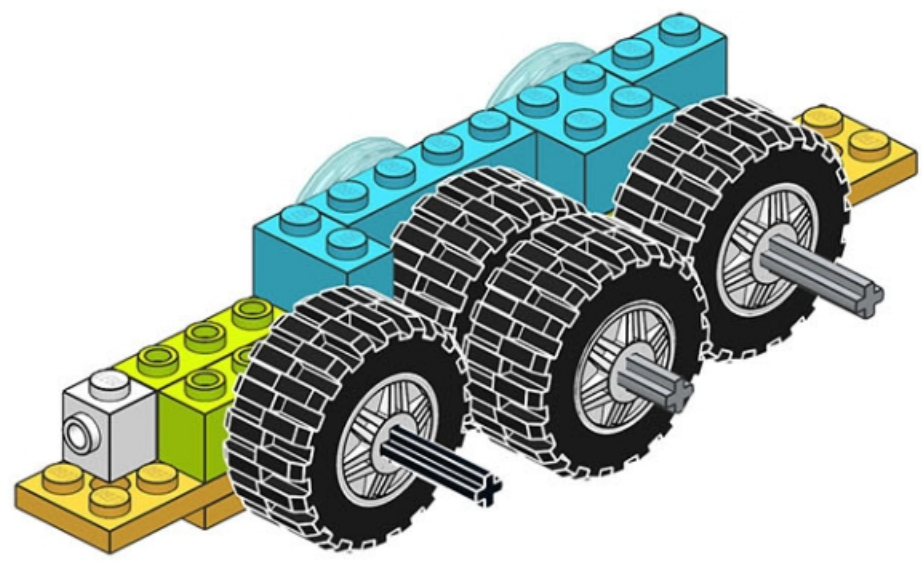

13/56

0

41



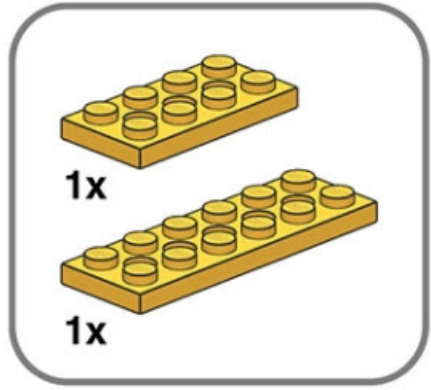

**14**

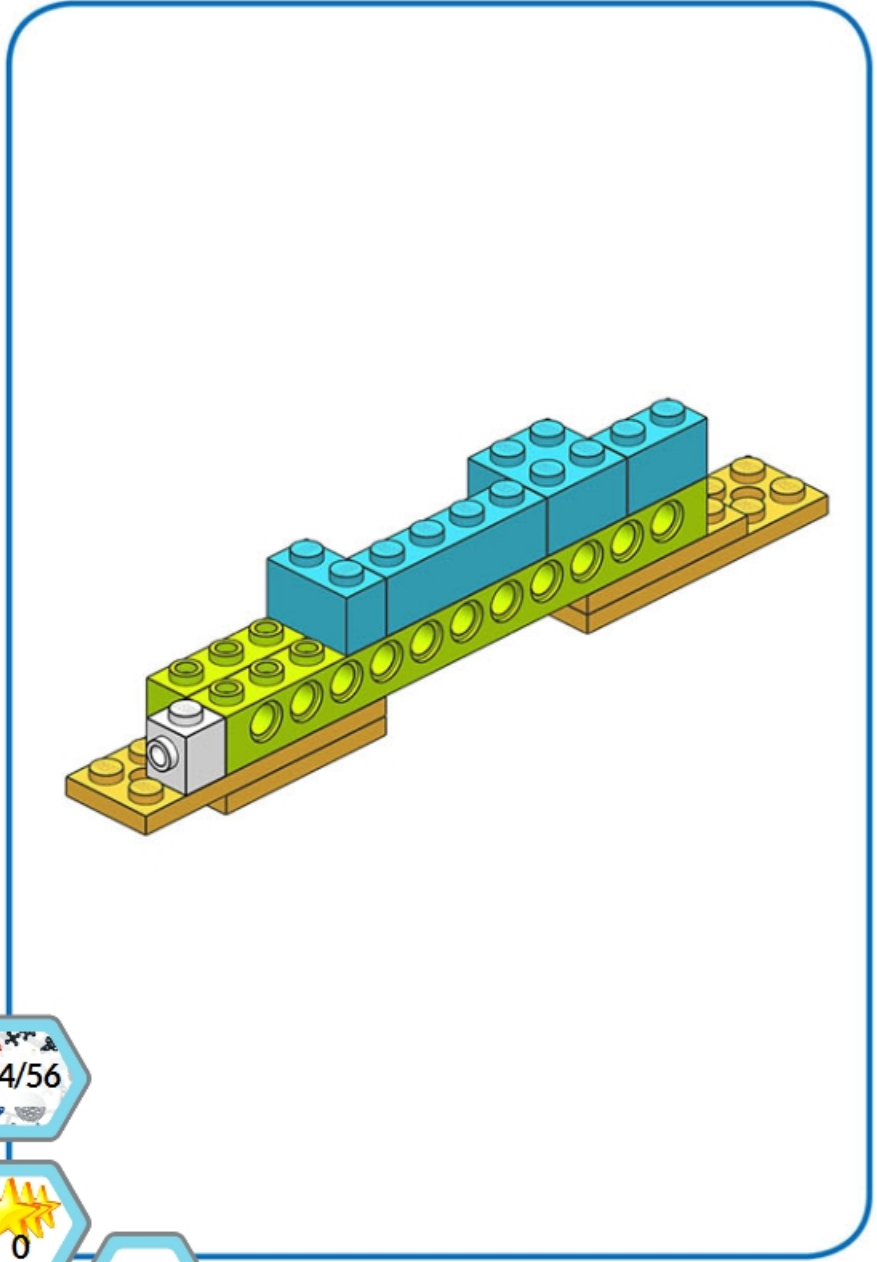
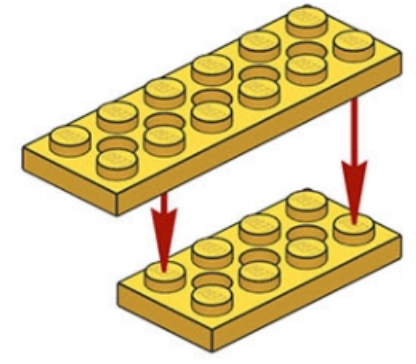

14/56

0

42

nerka@gmail.com

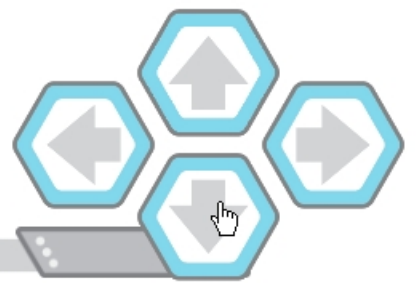

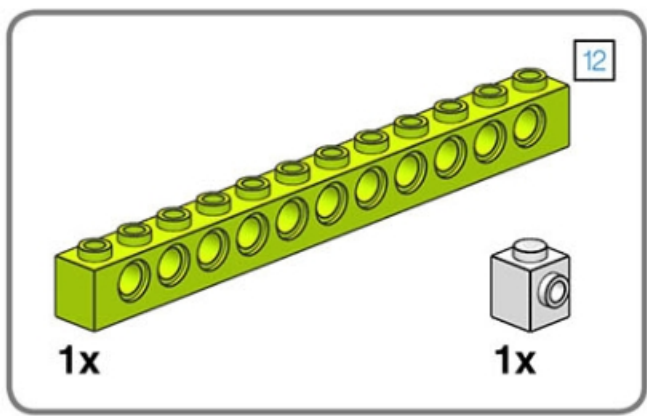

# 15

nerrka@gmail.com

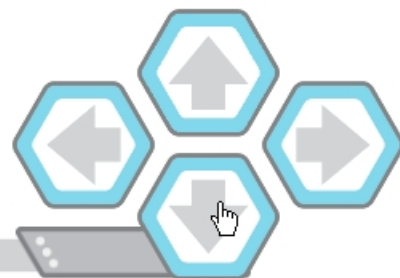
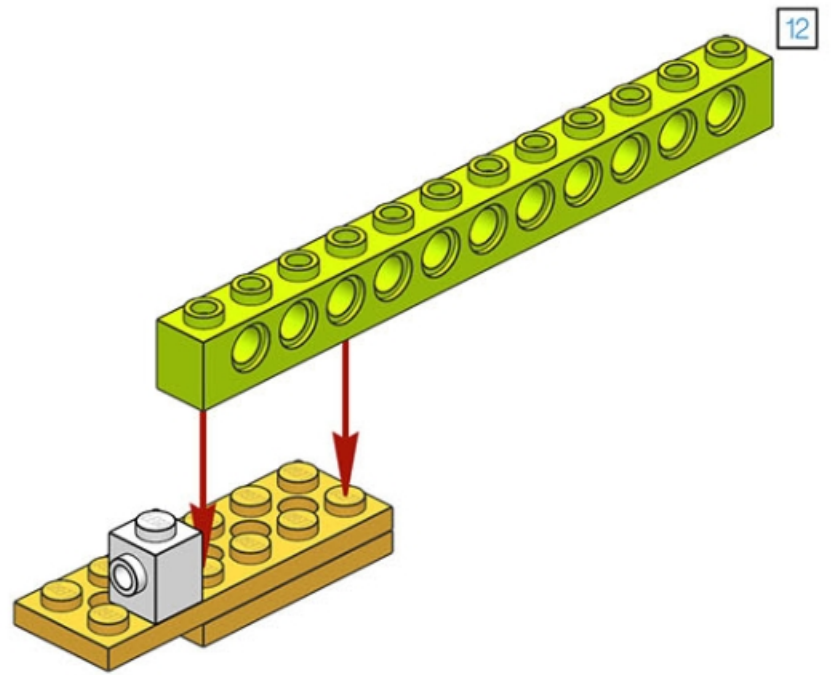



1x  
1x

1

2

nerka@gmail.com

16/56

0

44

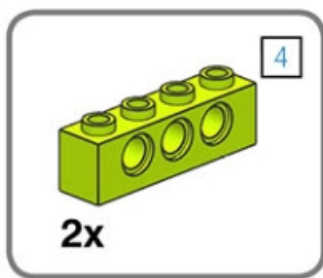

**17**

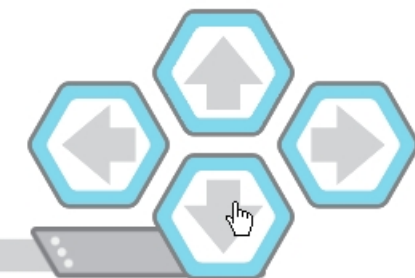
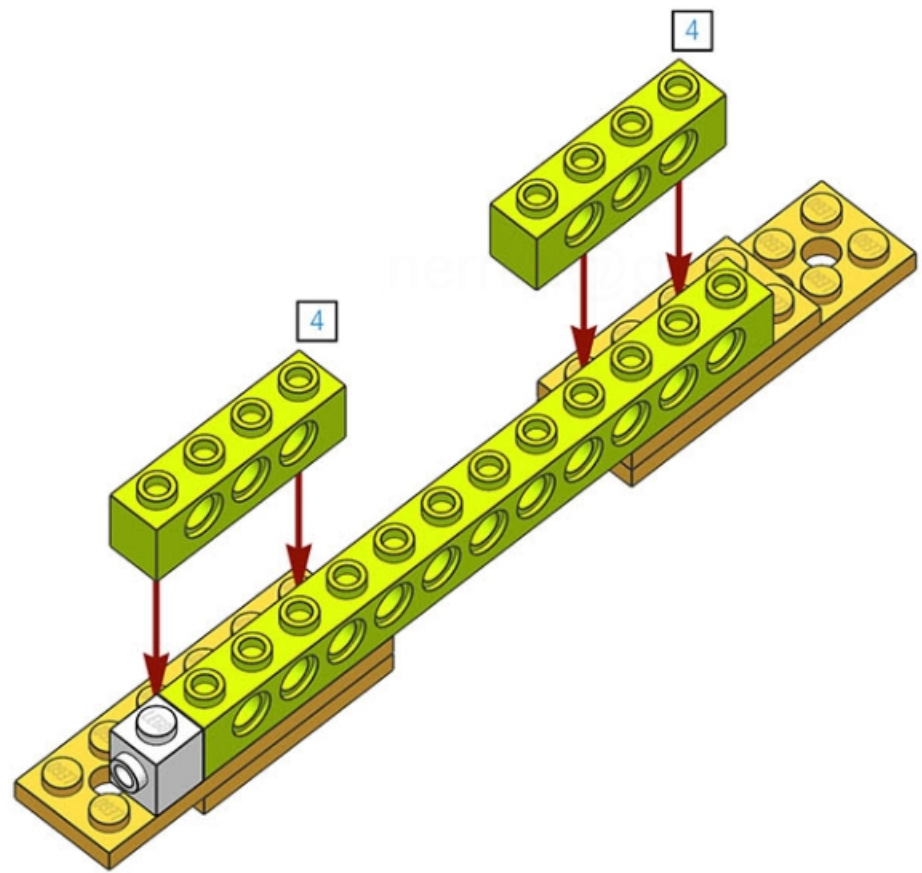

nerrka@gmail.com

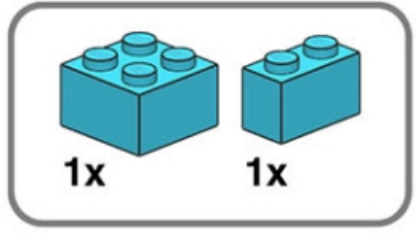

# 18

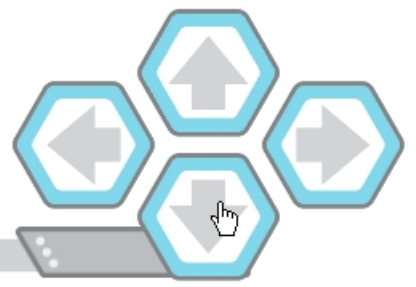
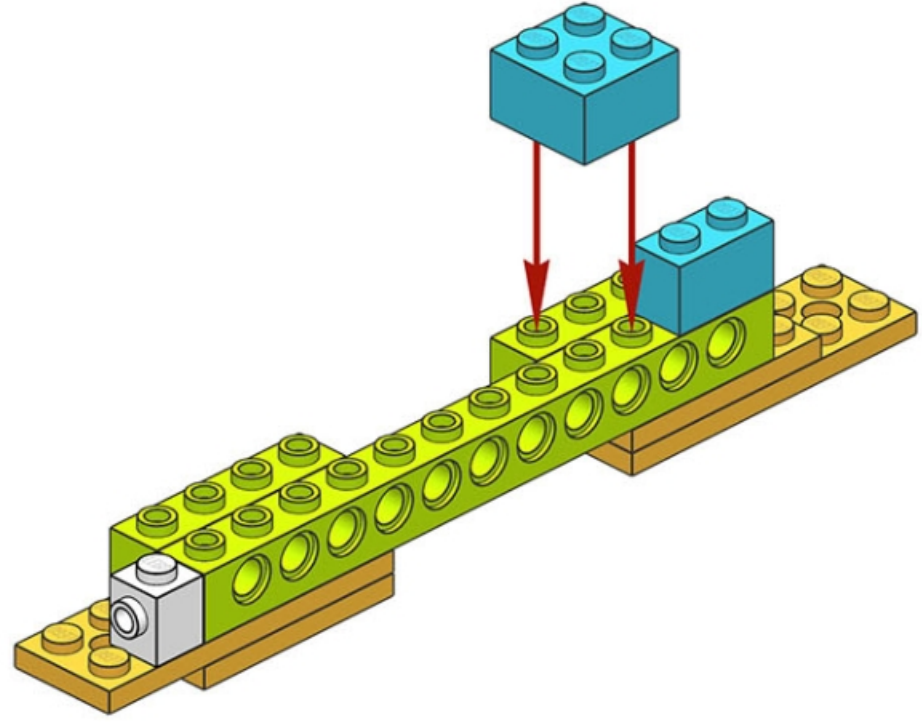

nerrka@gmail.com

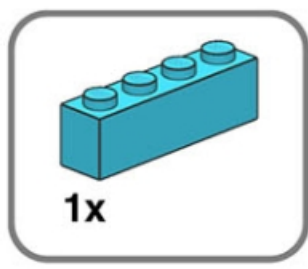

**19**

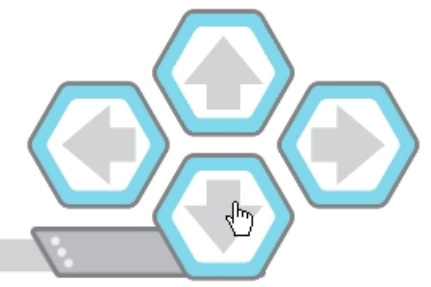
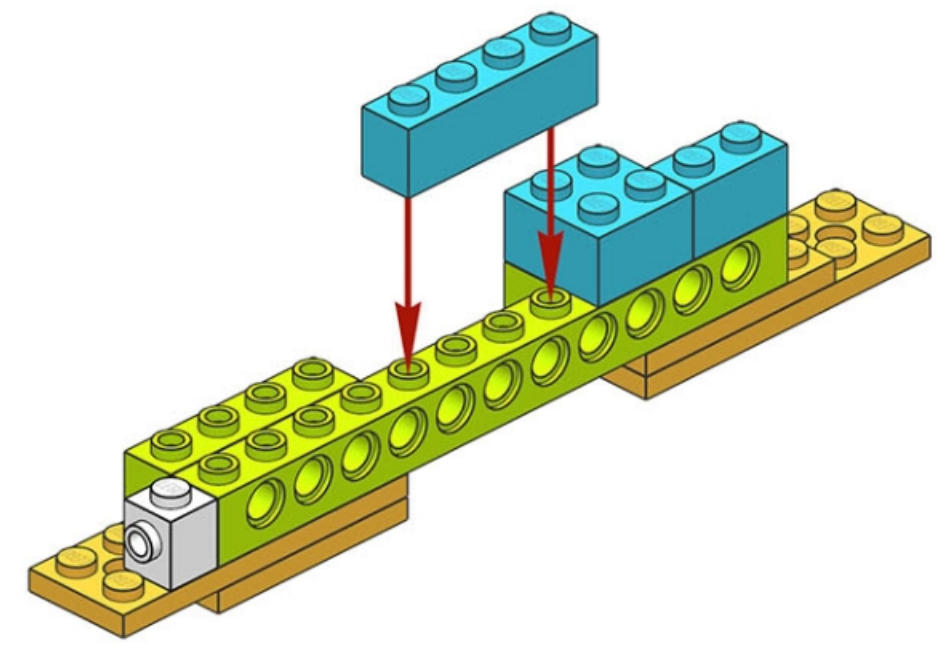

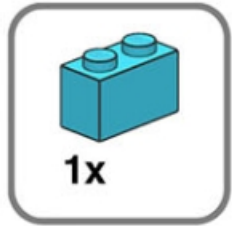

**20**

nerrka@gmail.com

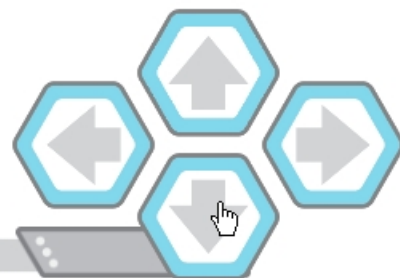
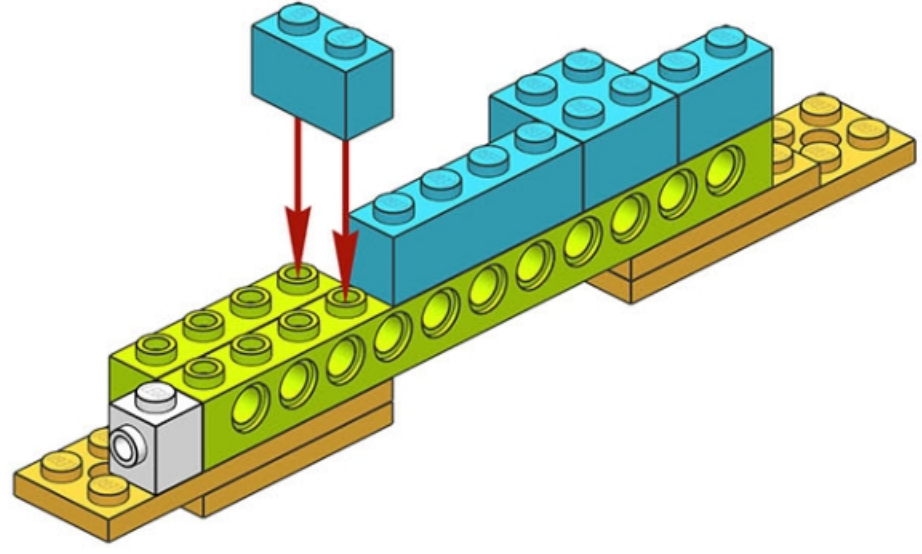

# 21

nerrka@gmail.com

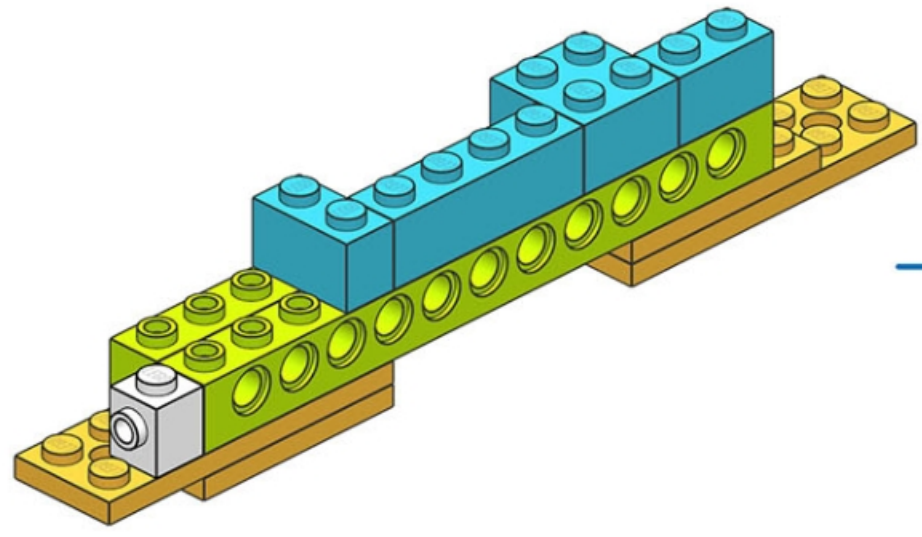

21/56

0

49

A vertical stack of three hexagonal icons. The top one contains the text '21/56' and a small gear icon. The middle one contains a yellow star icon and the number '0'. The bottom one contains a play button icon and the number '49'.

A cluster of four hexagonal navigation icons: up, down, left, and right arrows. A mouse cursor is pointing at the down arrow icon.

# 22

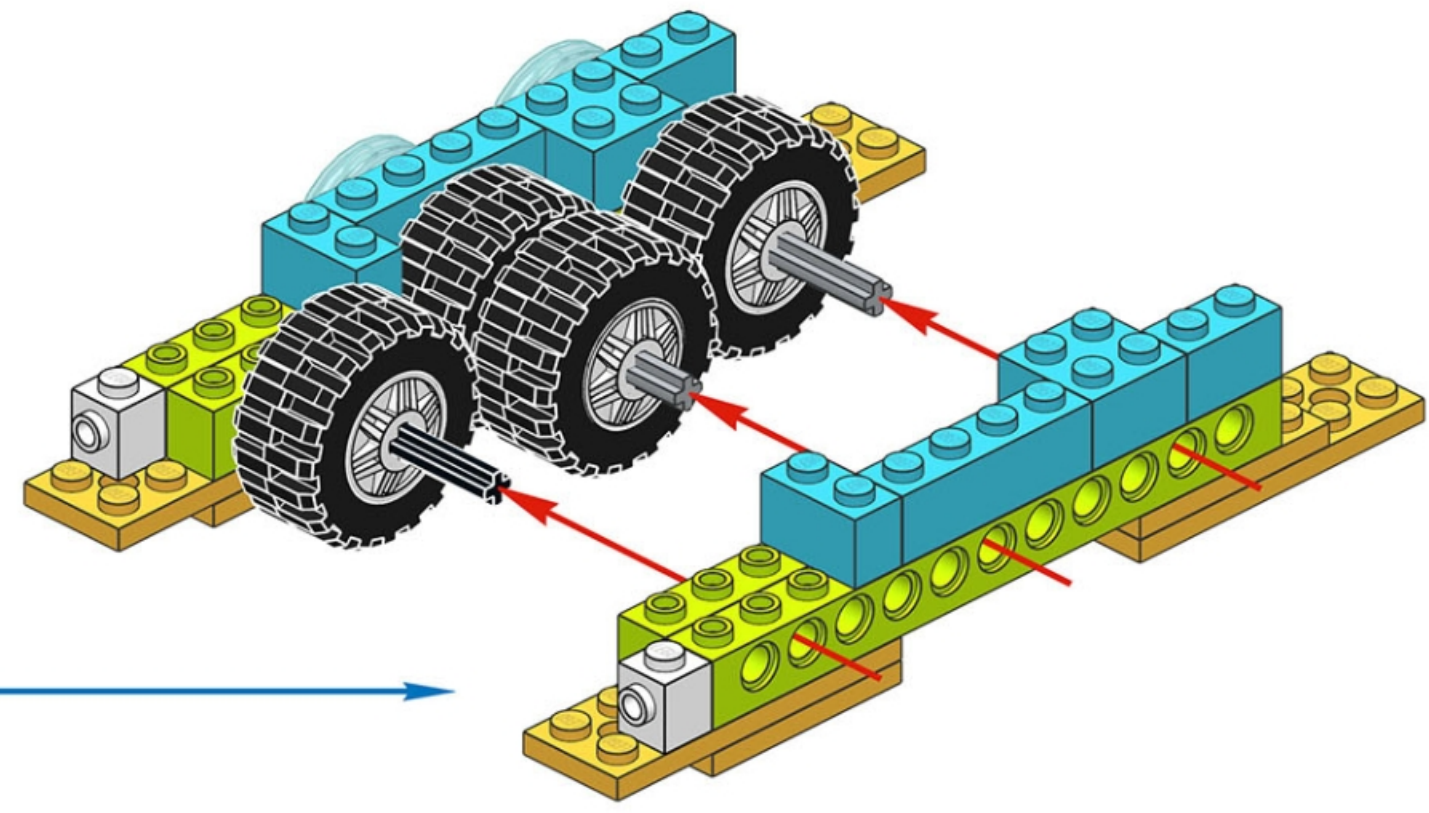

22/56

0

50

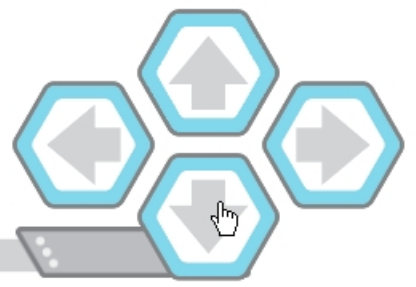

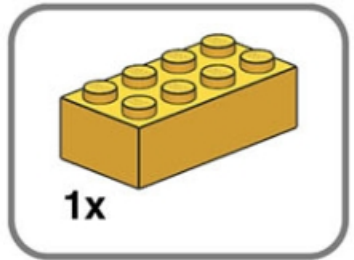

**23**

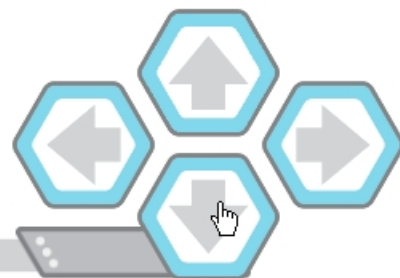
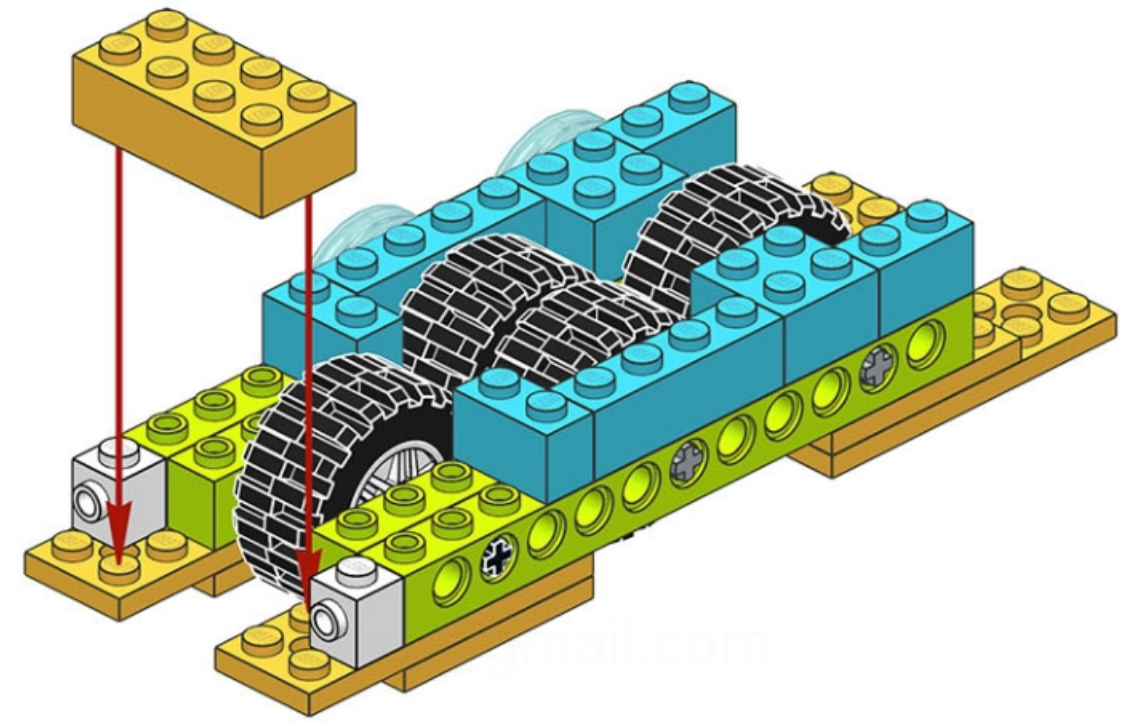



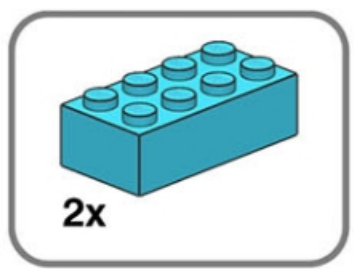

**24**

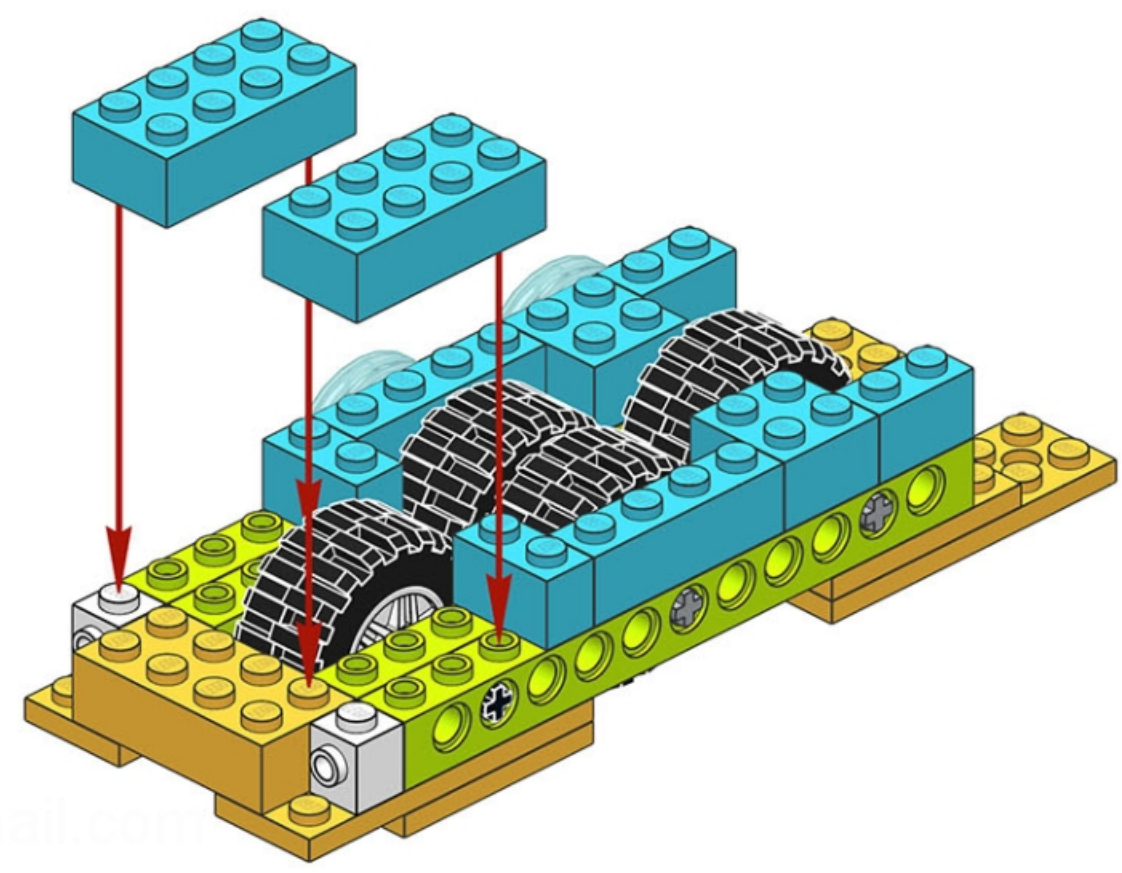

nerrka@gmail.com

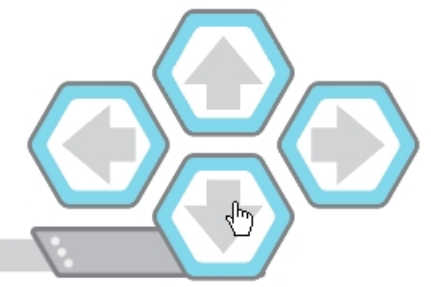

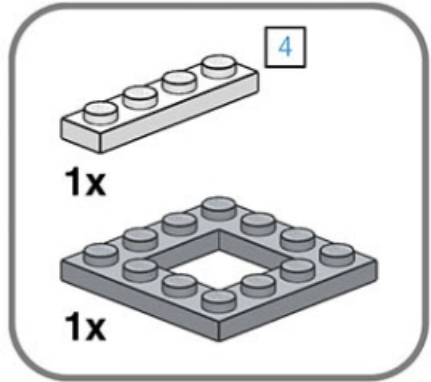

**25**

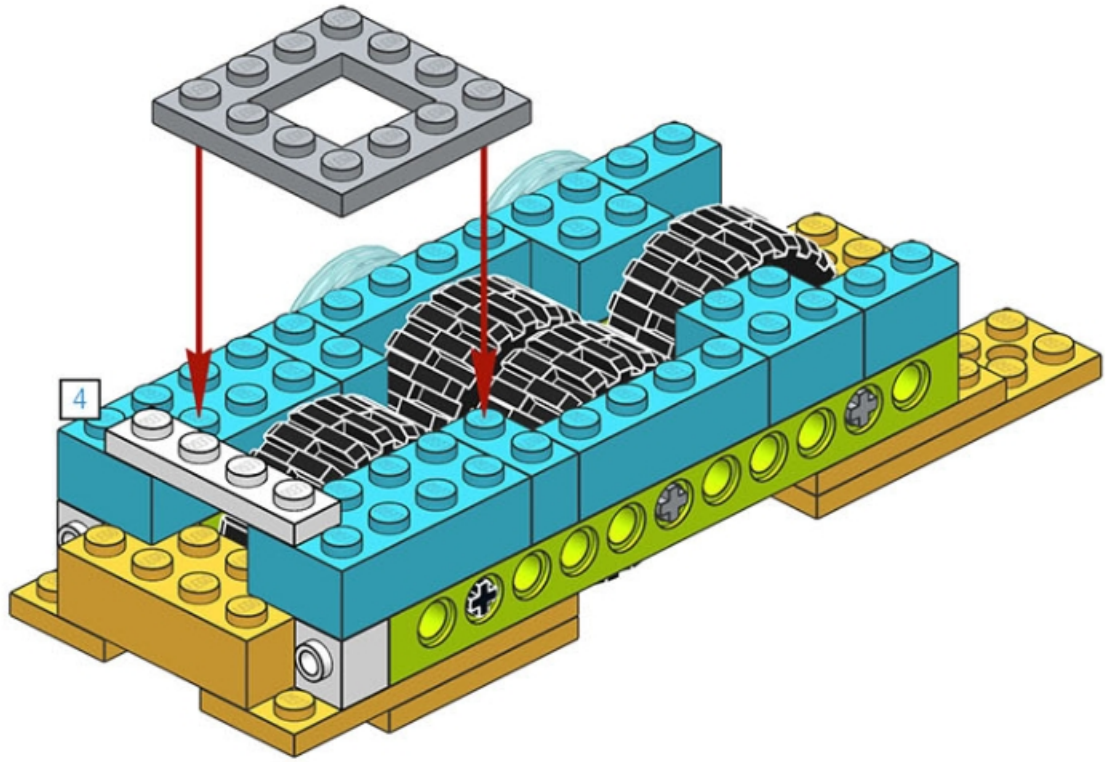

nerka@gr

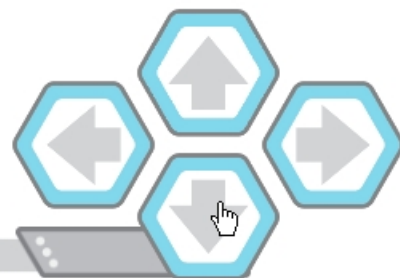

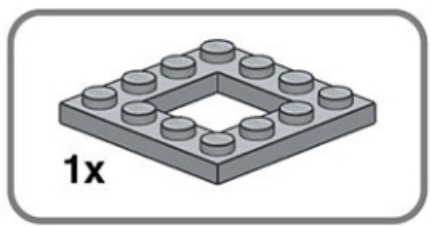

**26**

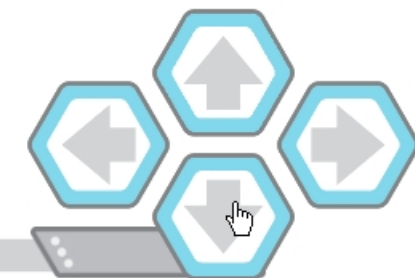
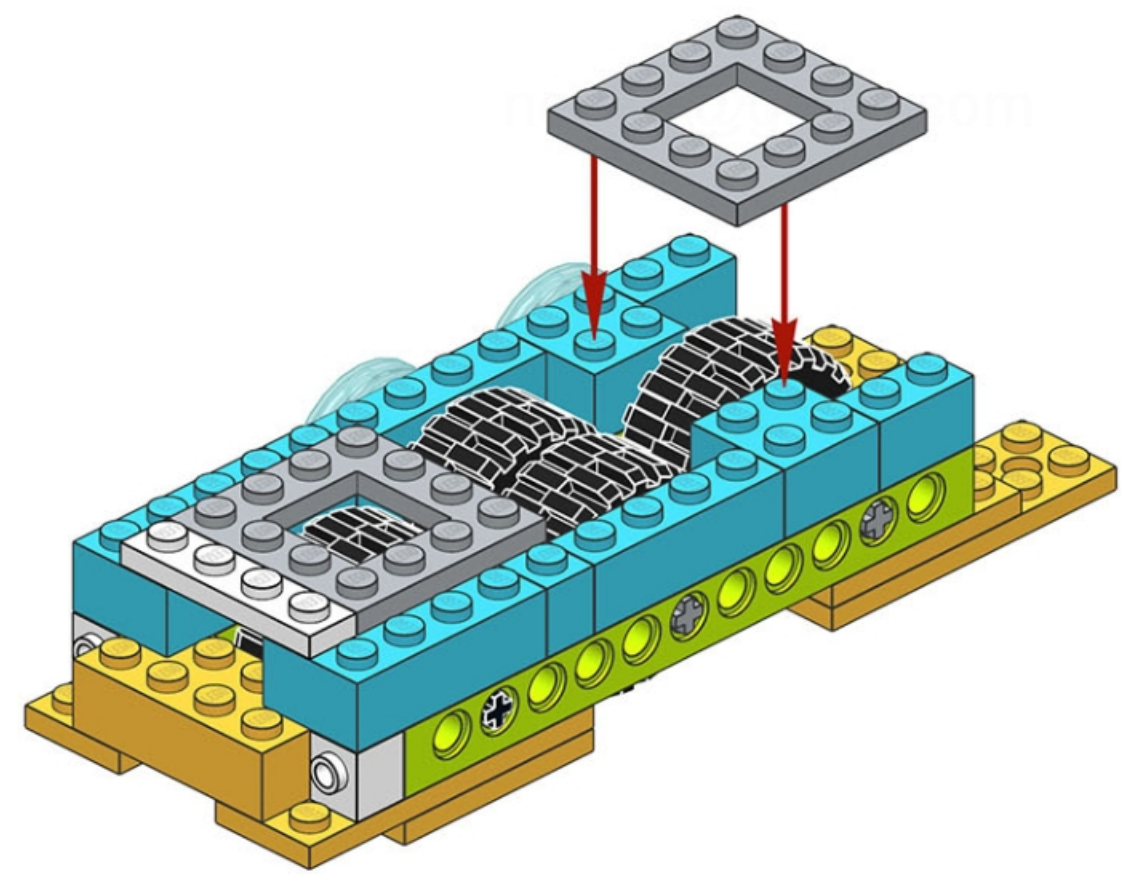

27

nerka@y

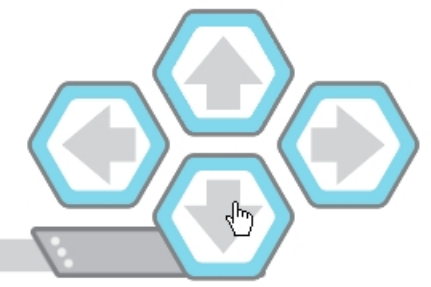
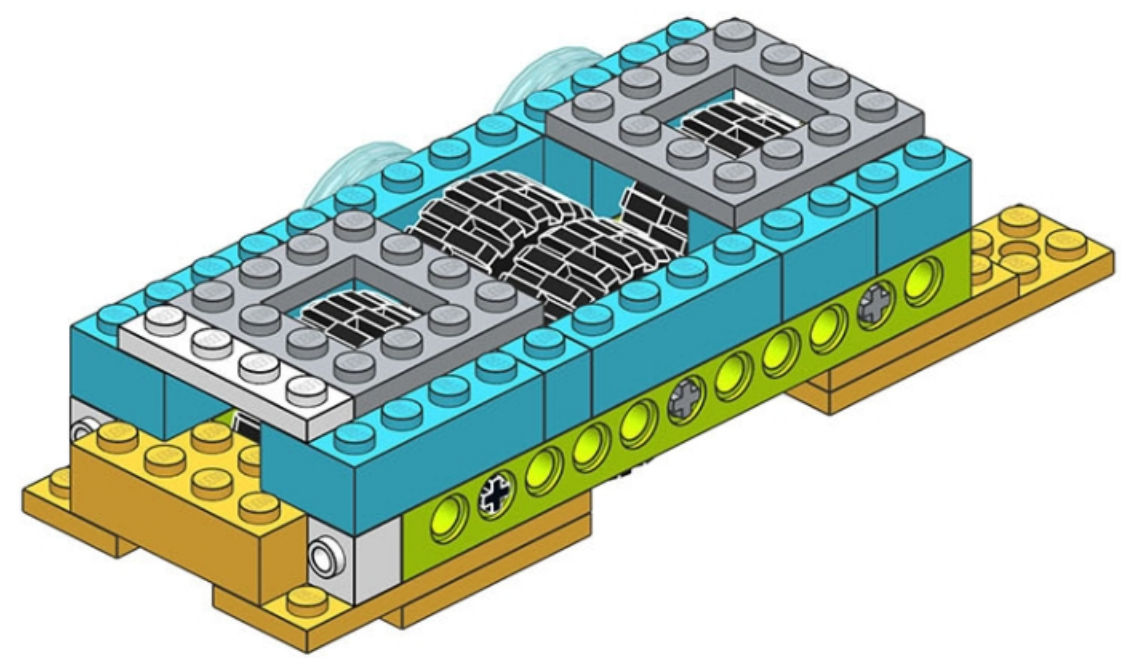

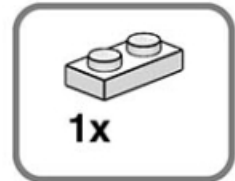

2

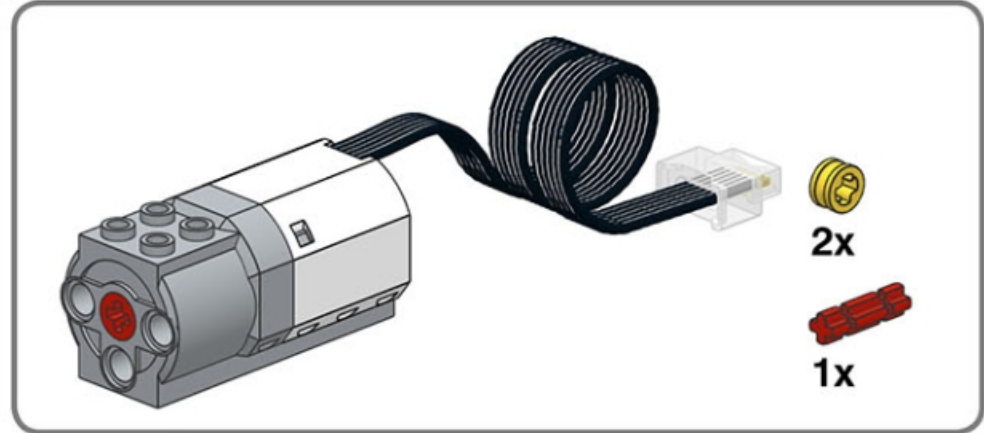
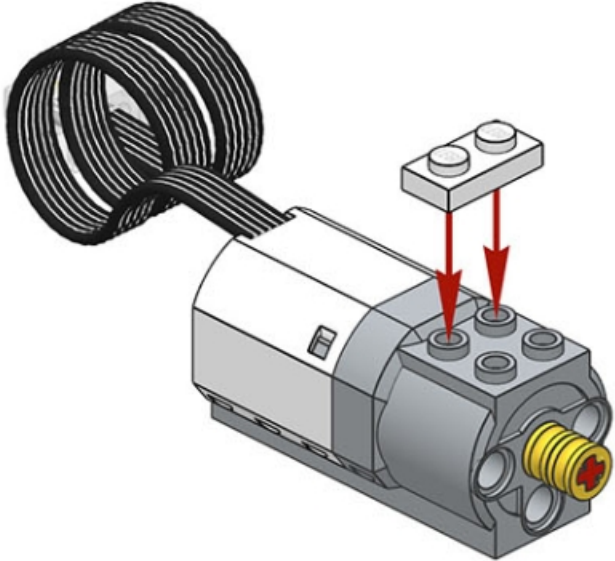

1

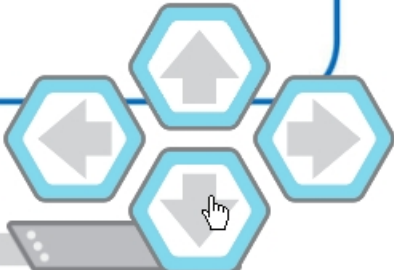
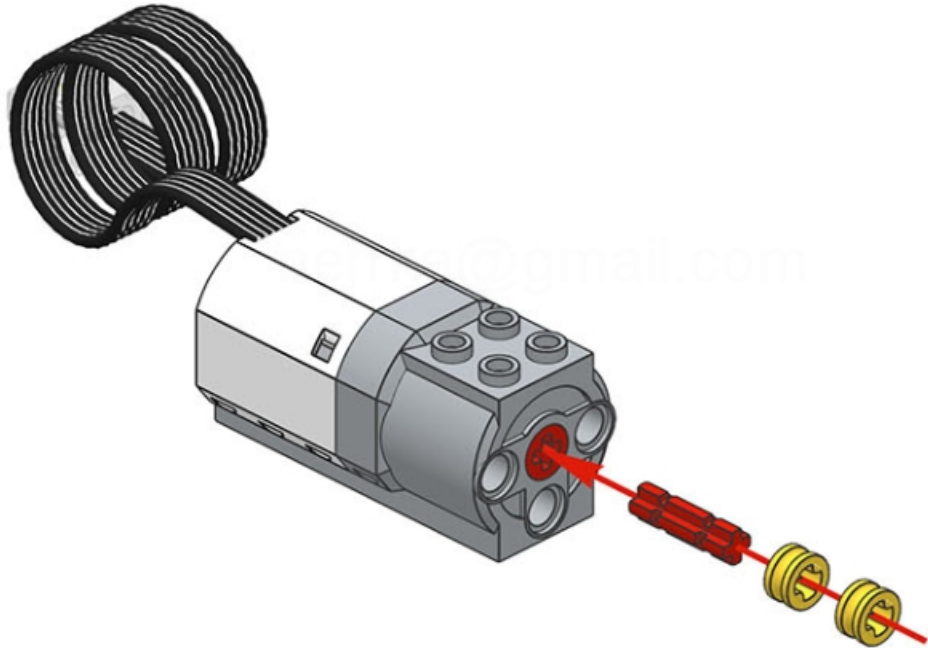

29

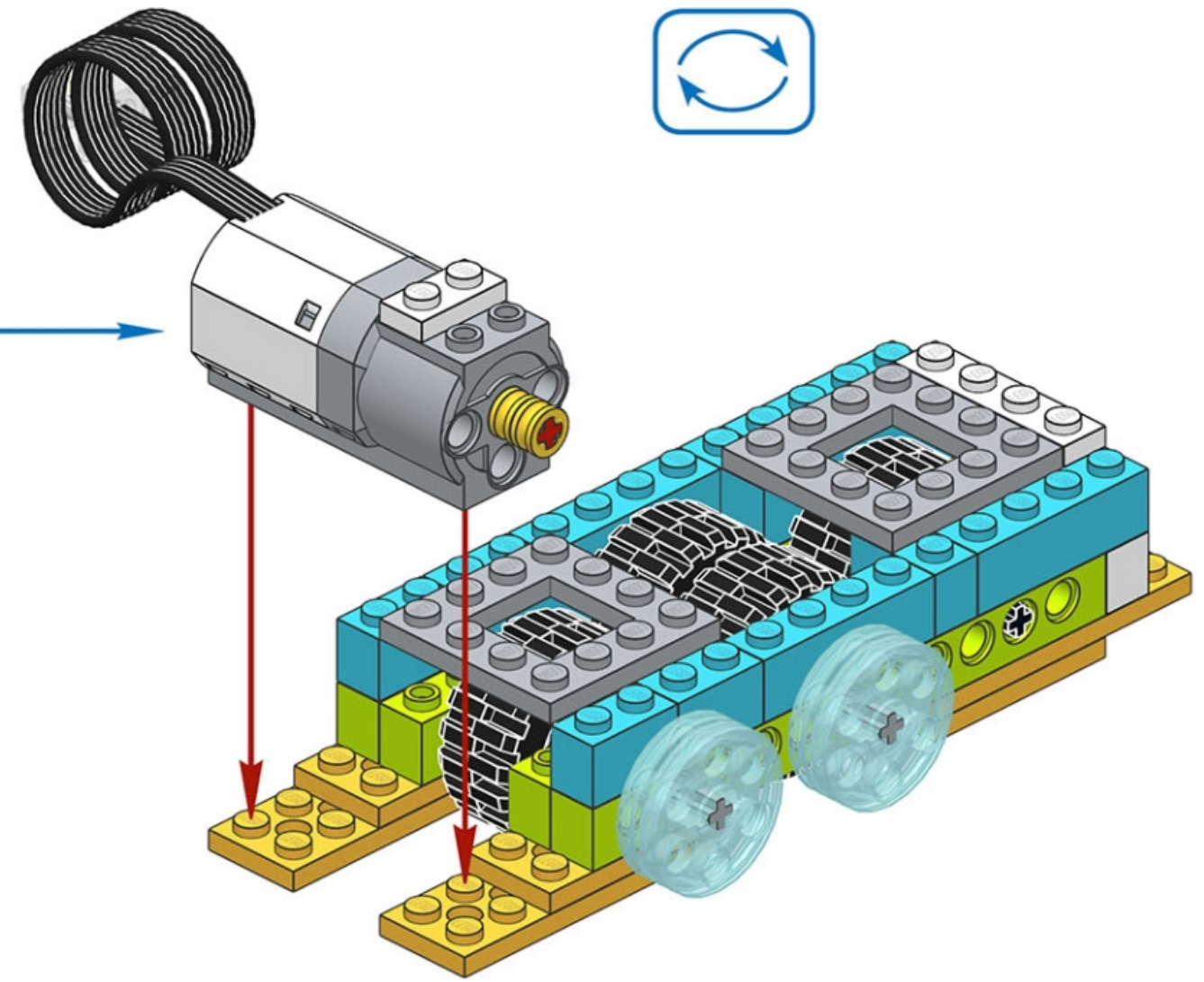

nerka@gmail.com

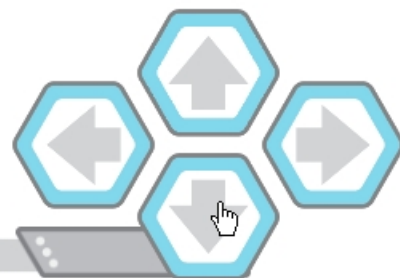

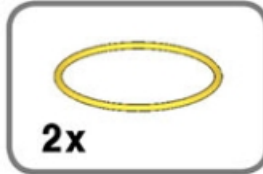

# 30

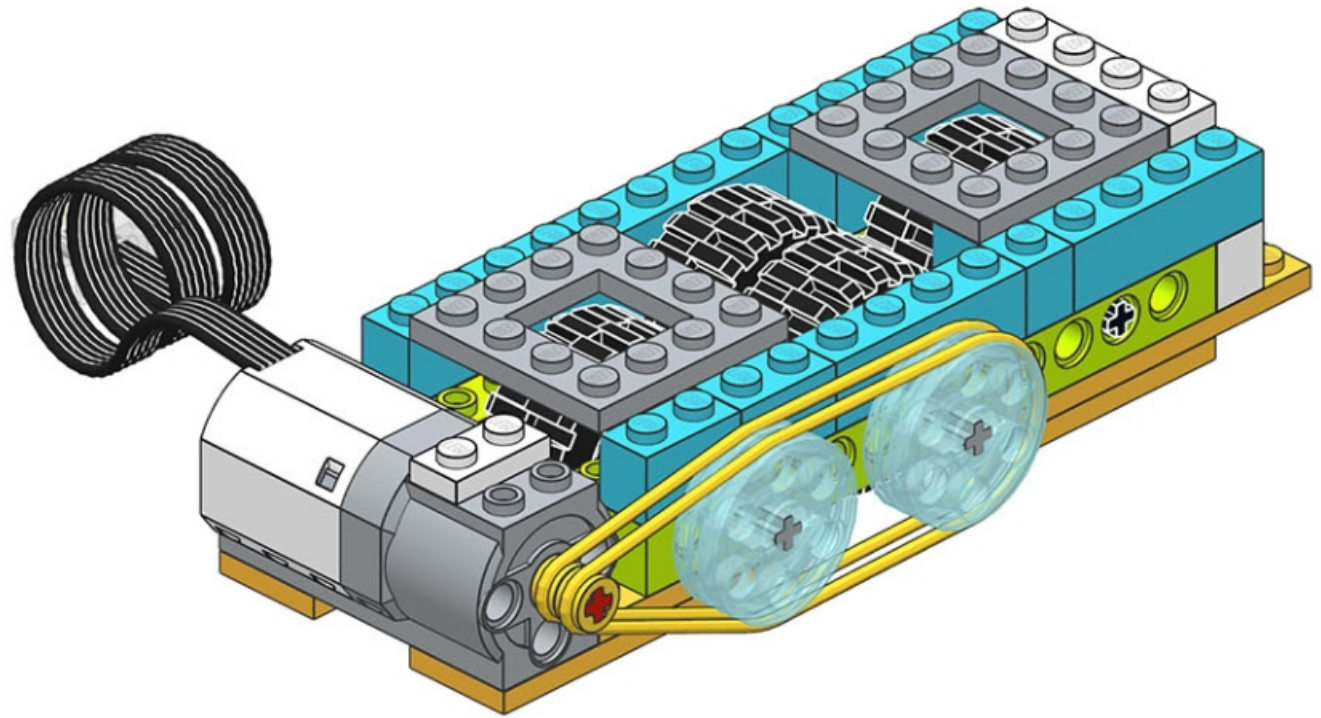

nerrka@gmail.com

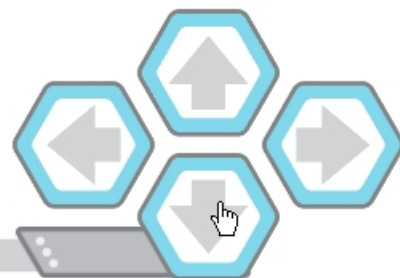

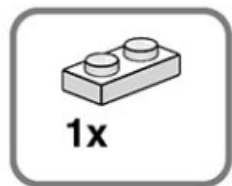

**31**

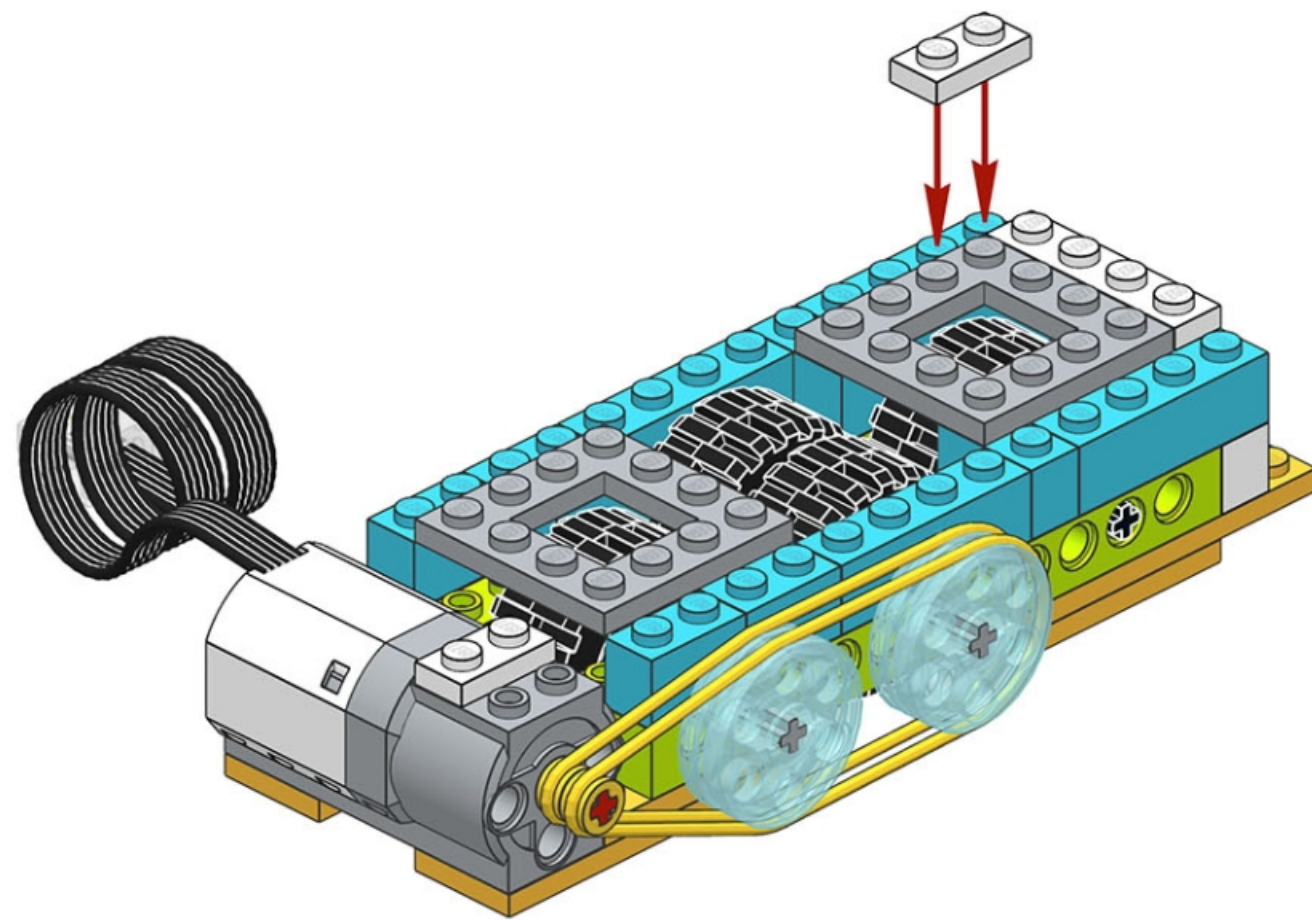

nerrka@gmail.com

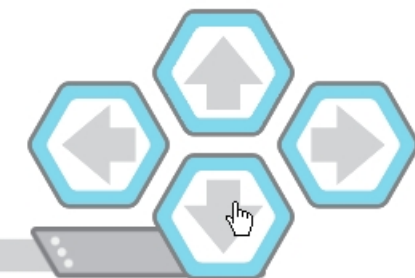



nerrka@gmail.com

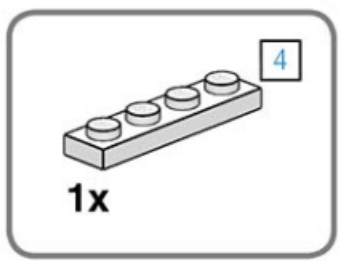

**32**

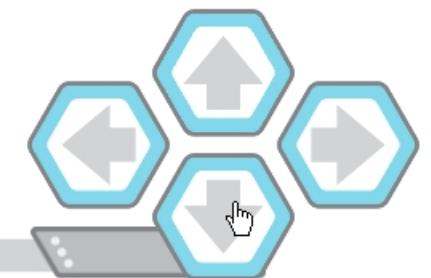
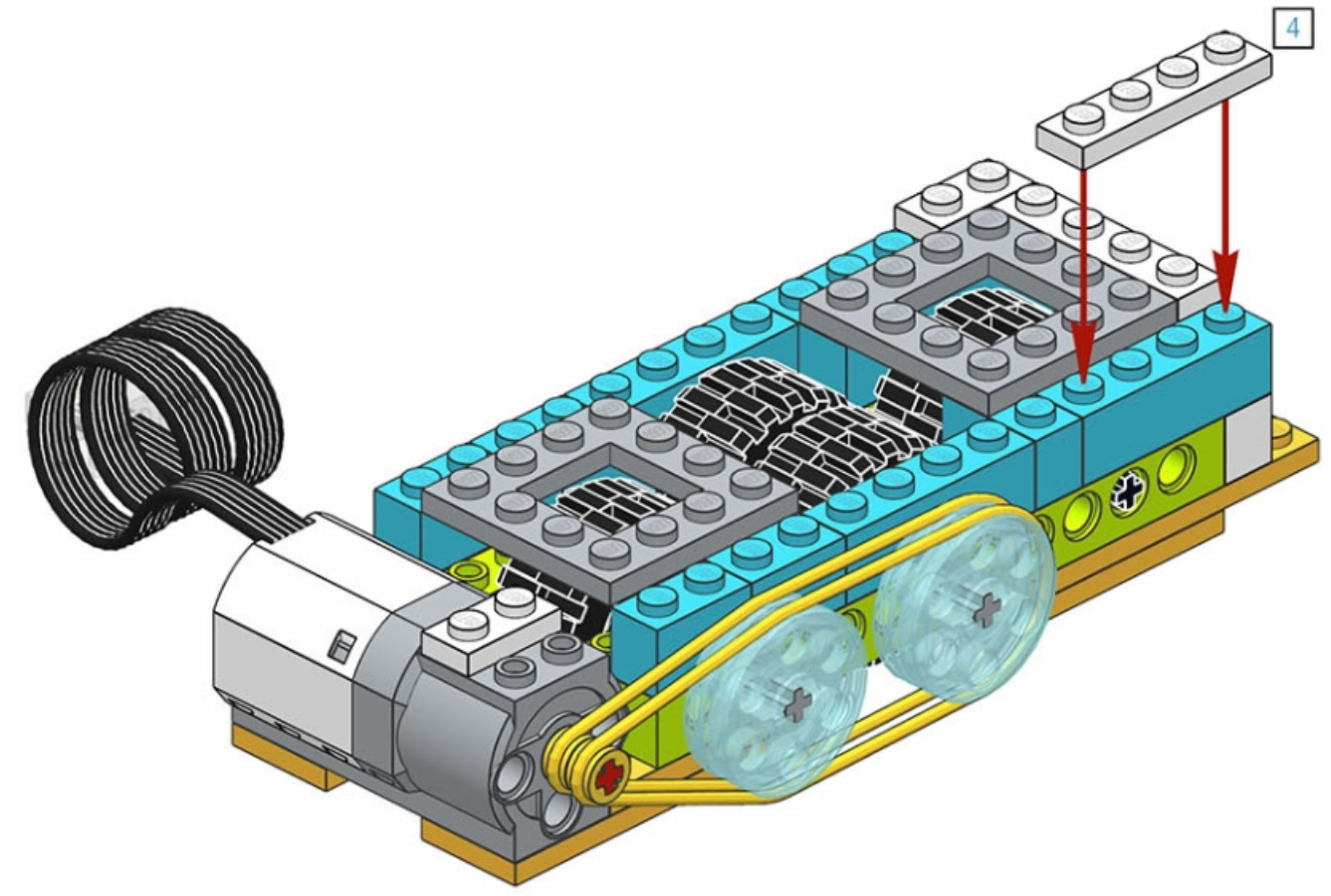

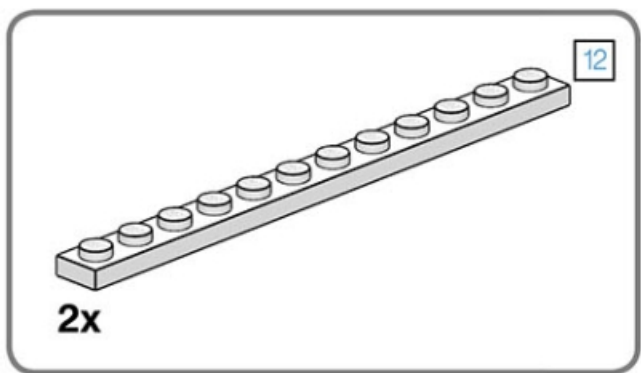

# 33

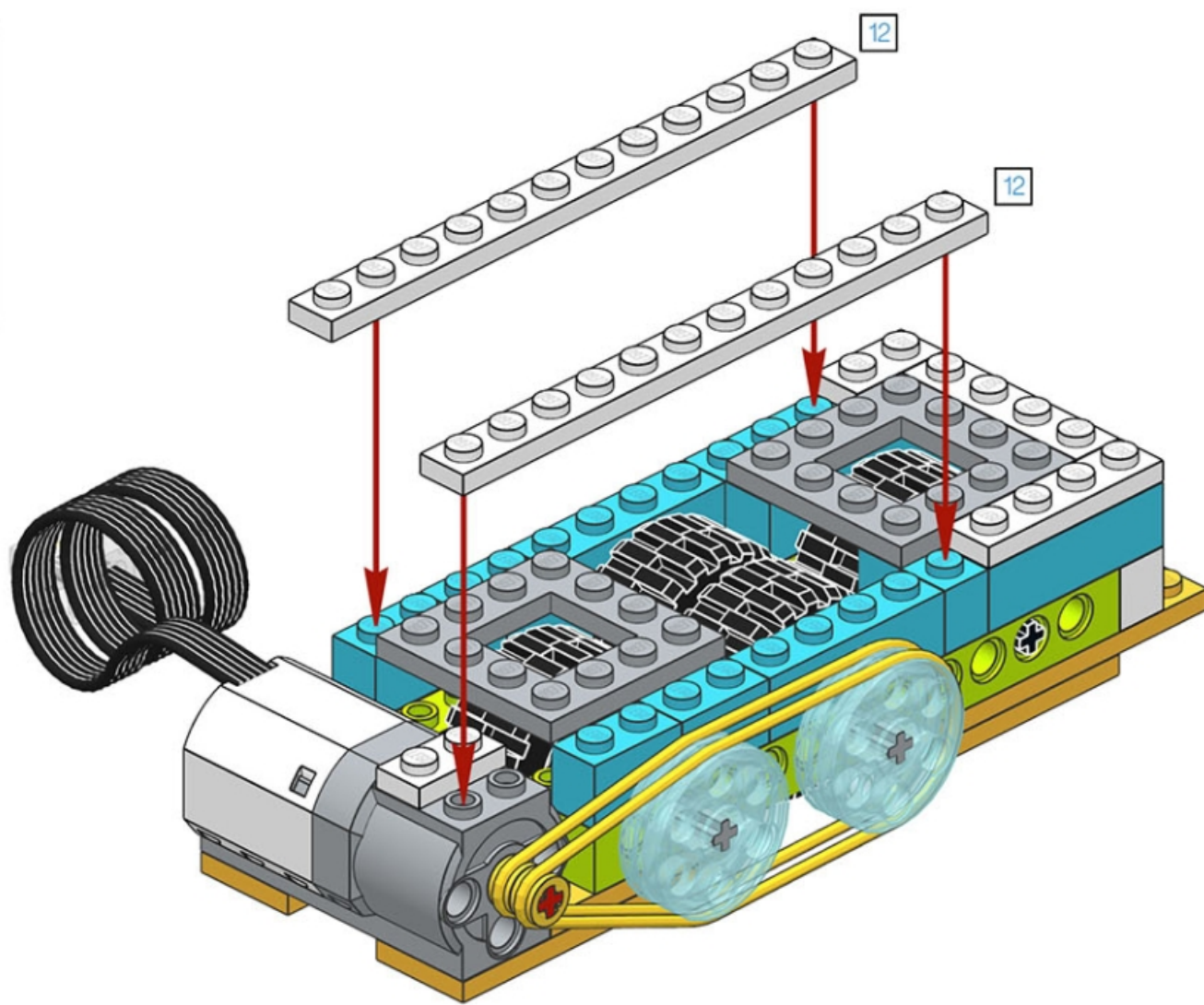

33/56

0

61

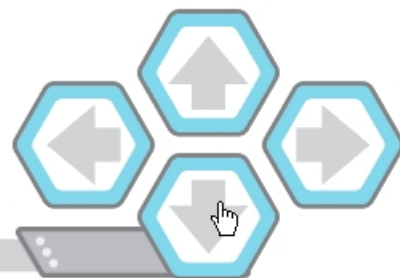

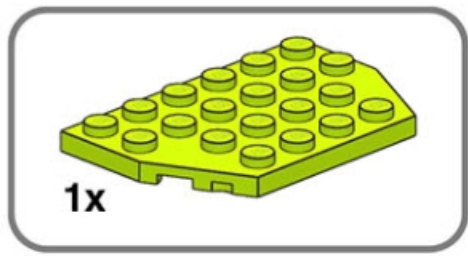

**34**

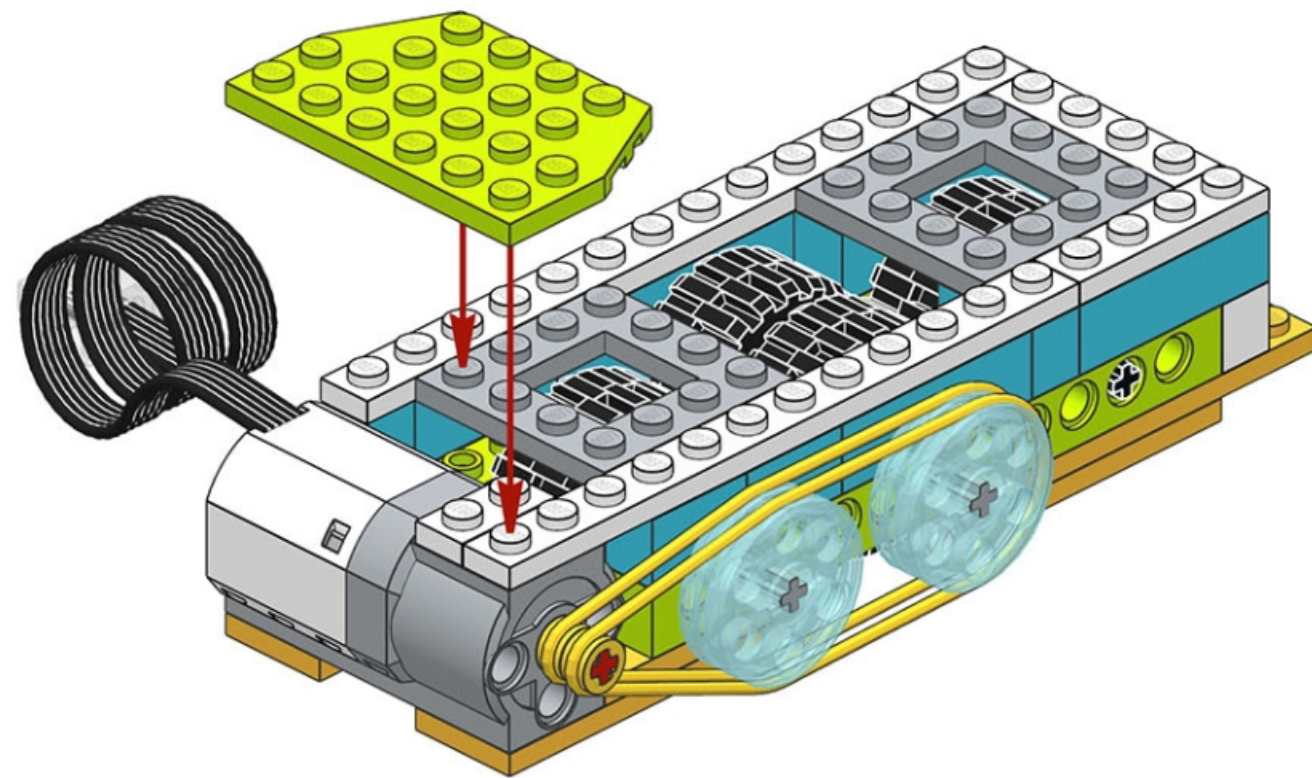

34/56

0

62

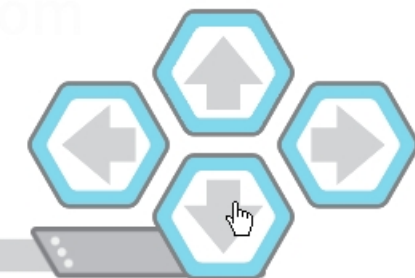

nerka@gmail.com

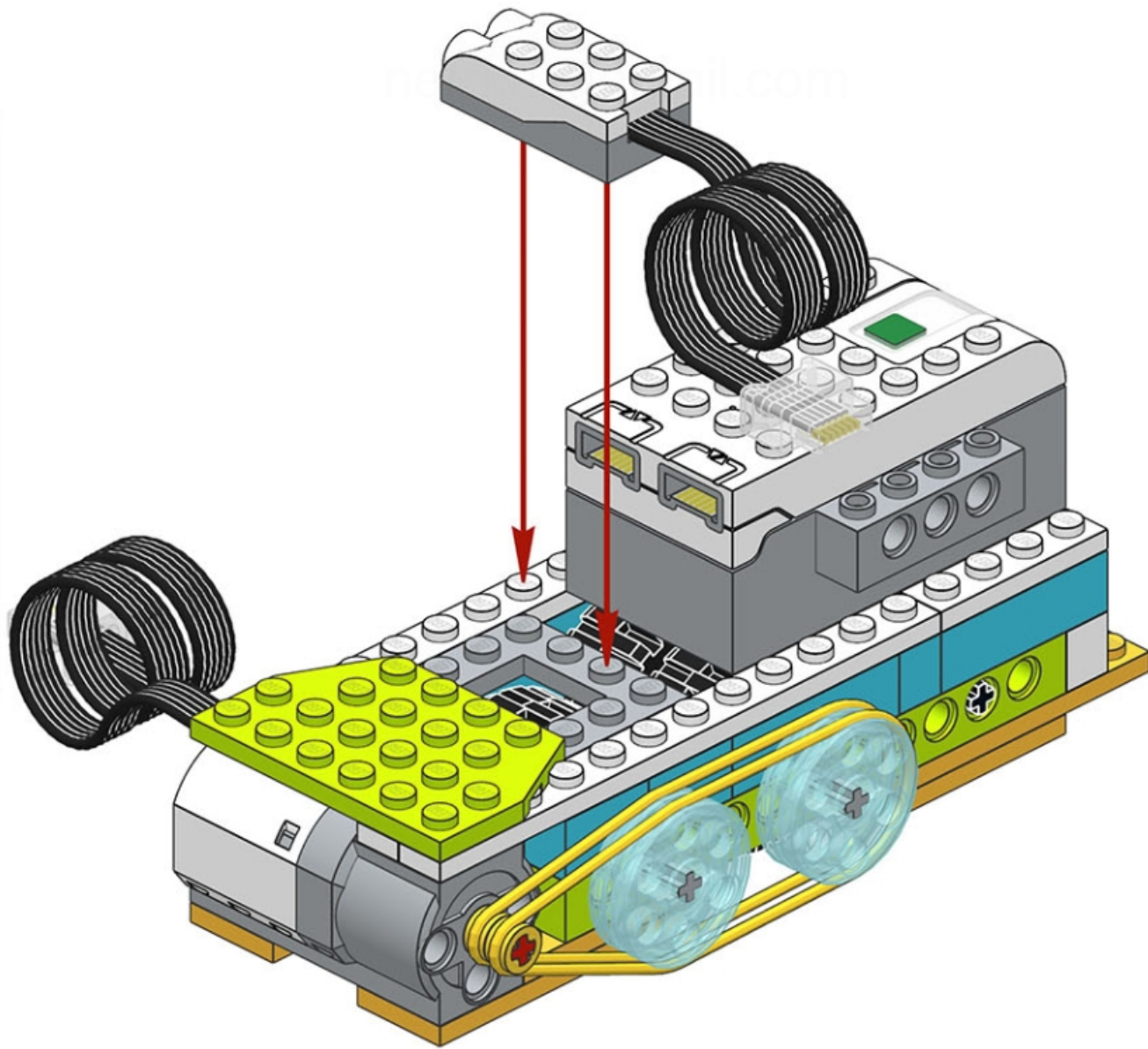
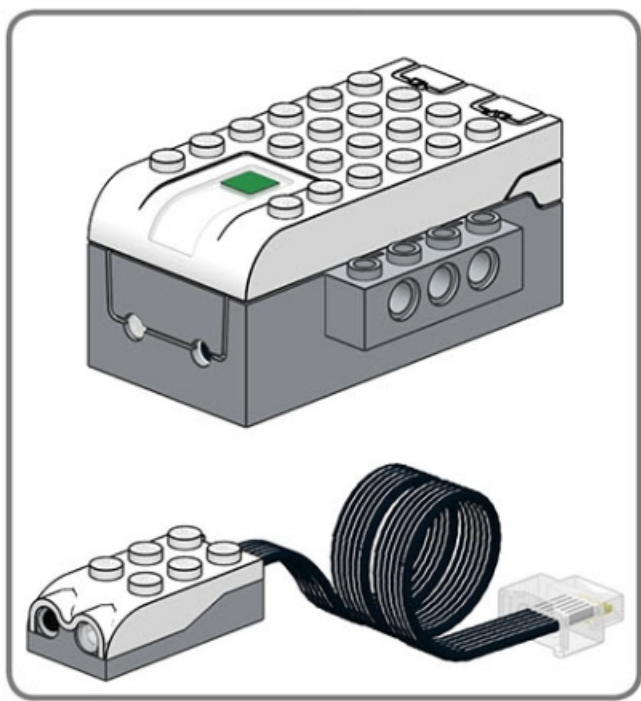

**35**

35/56

0

63



# 36

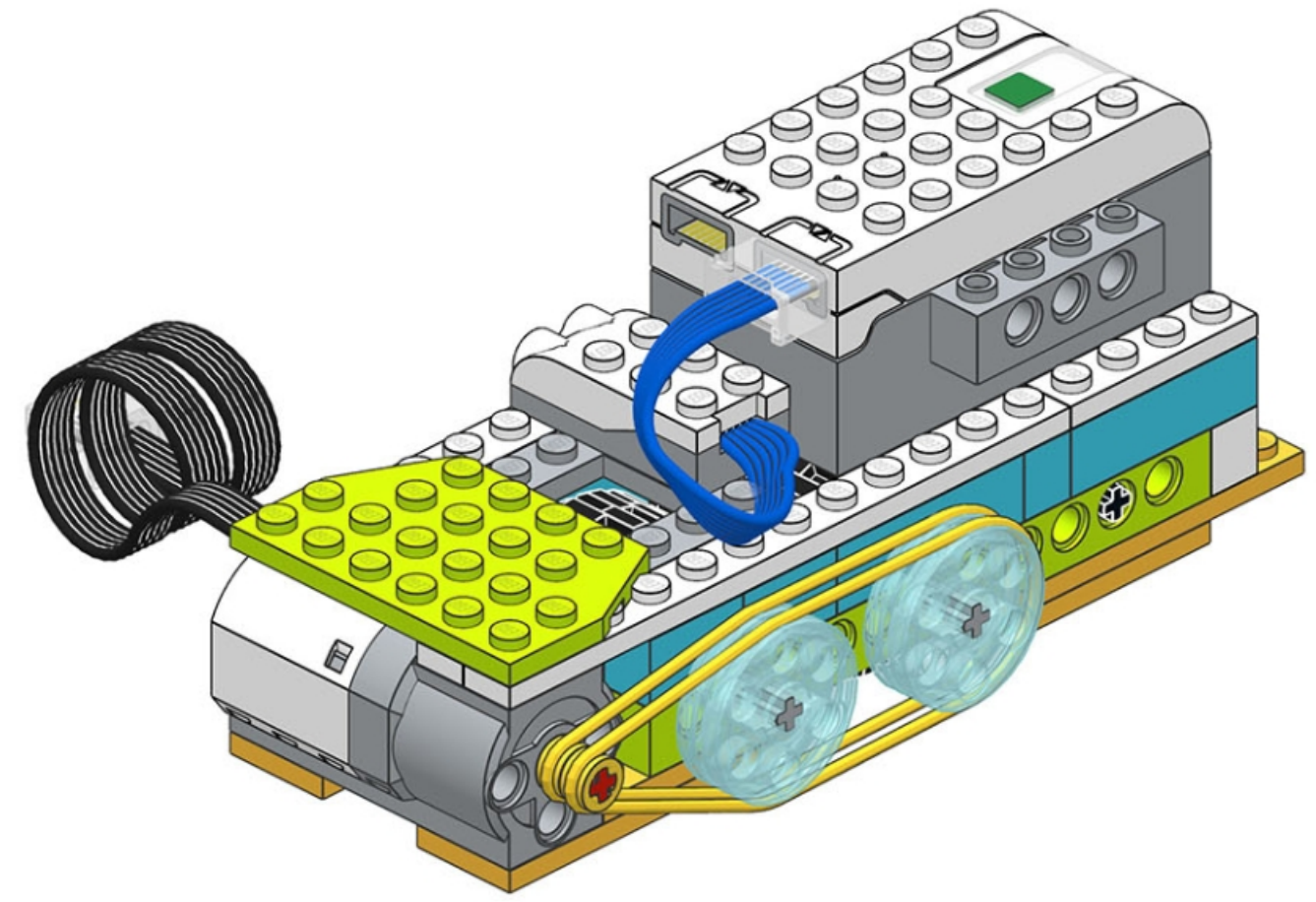

36/56

0

64



nerka@gmail.com

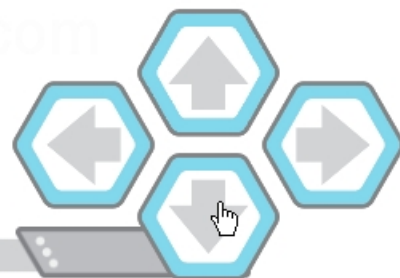



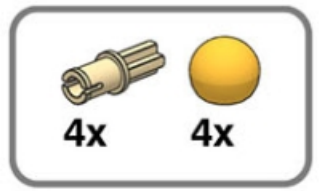

**38**

nerrka@gmail.com

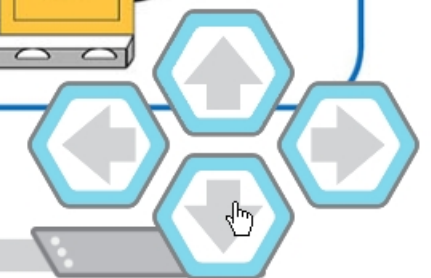
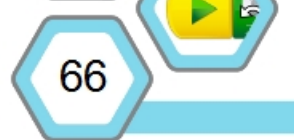
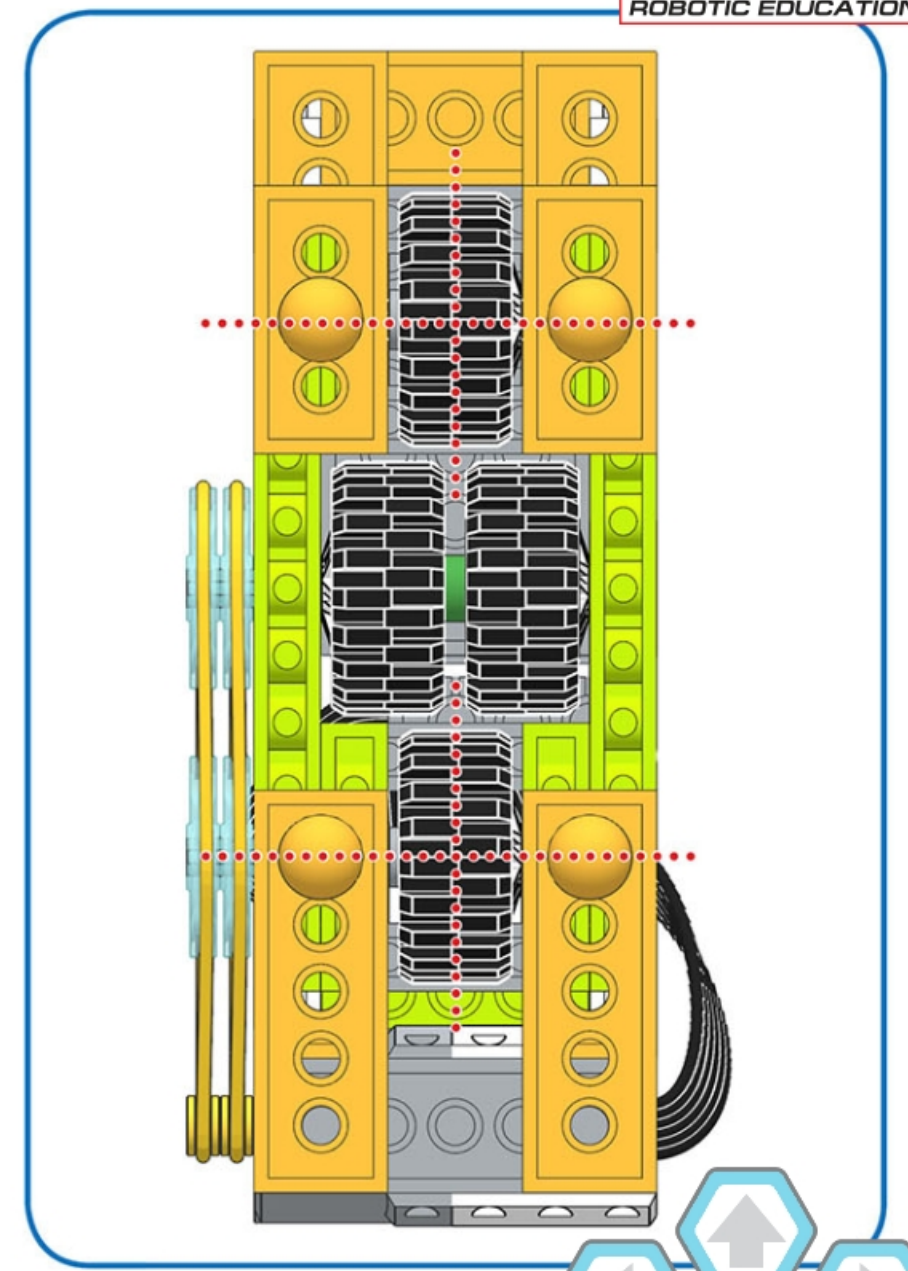
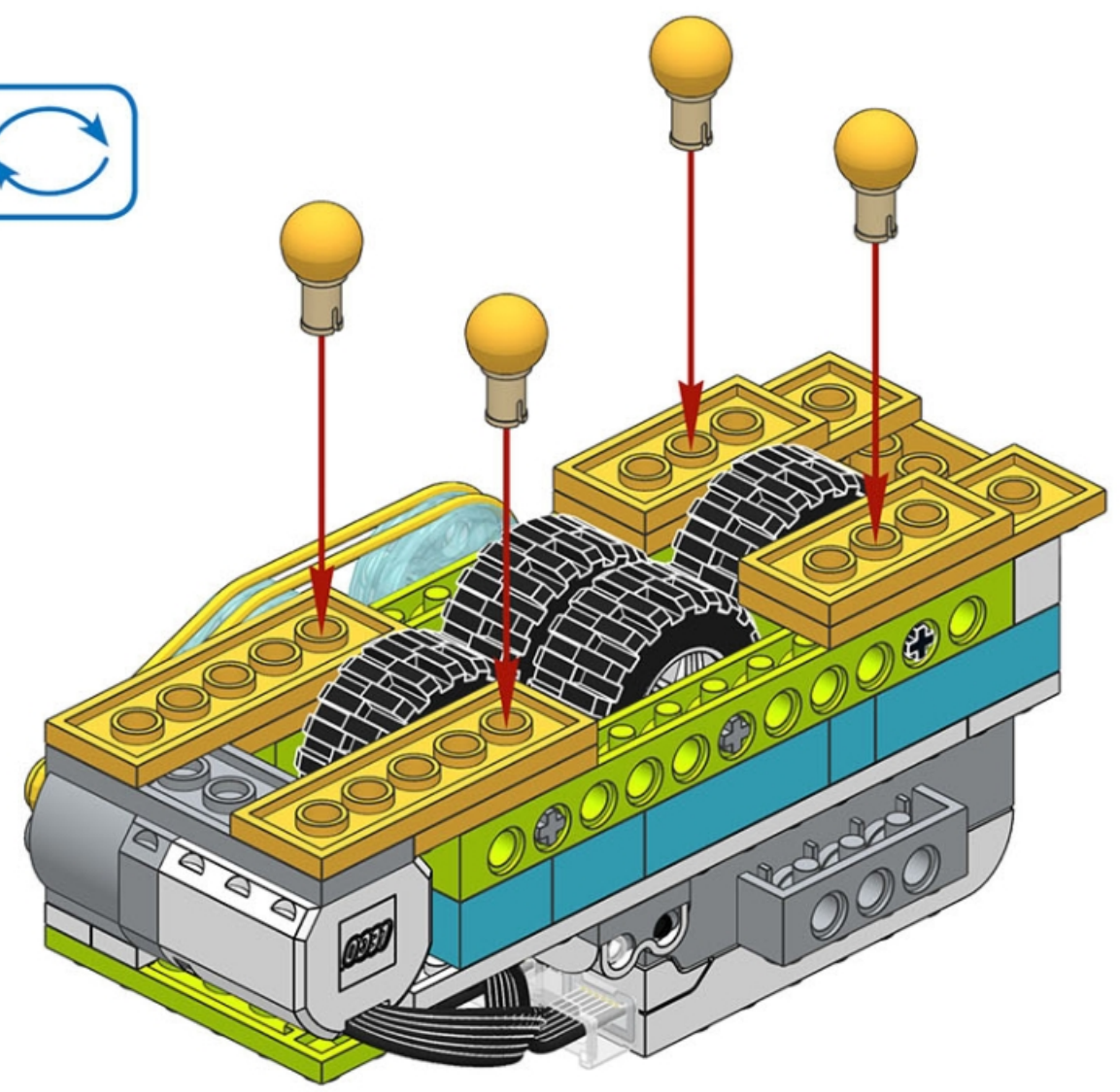

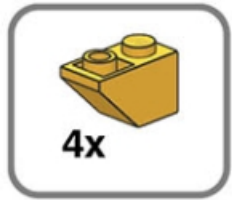

**39**

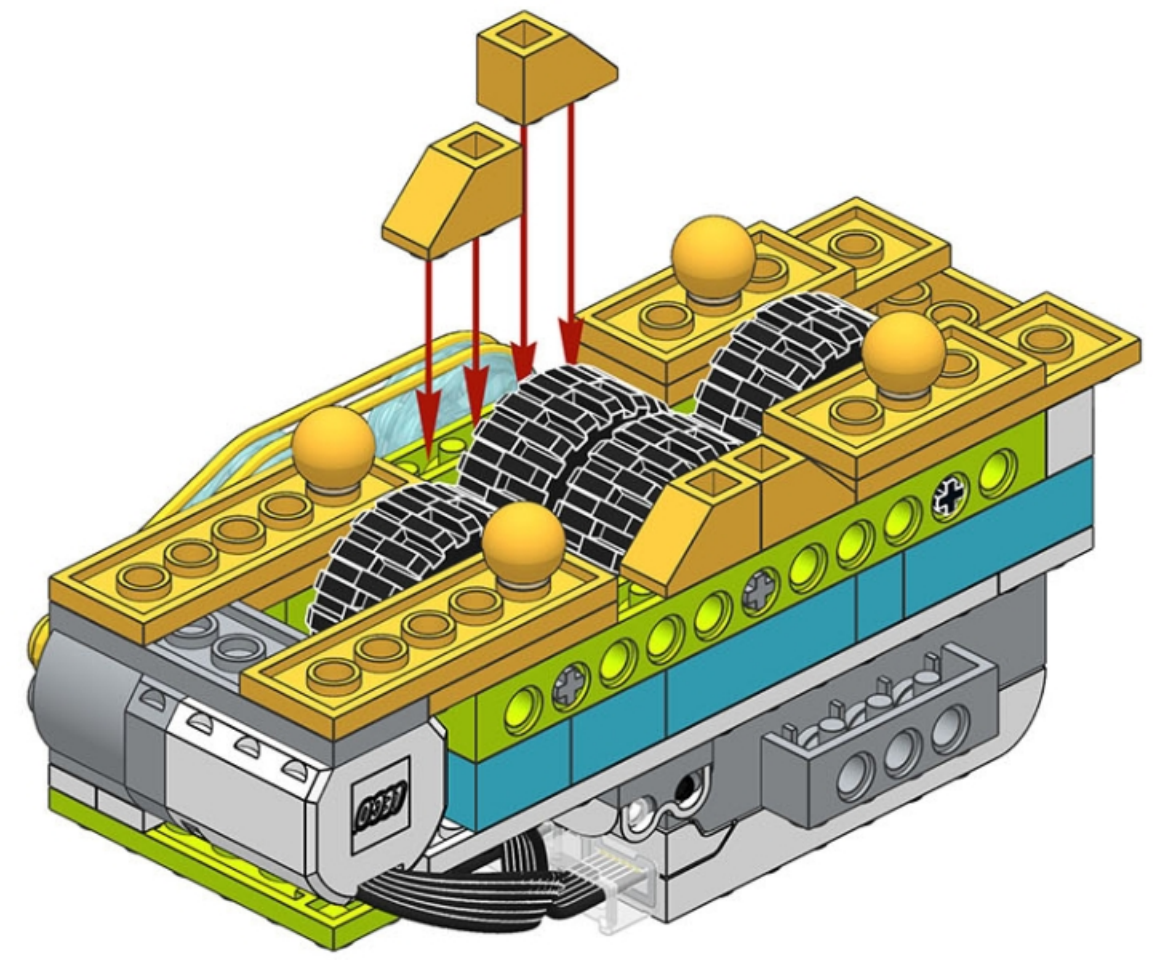

nerrka@gmail.com

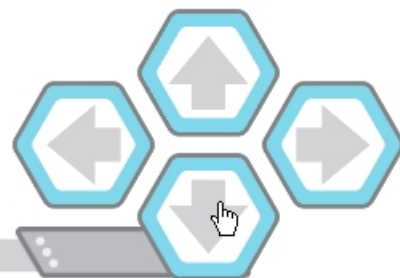



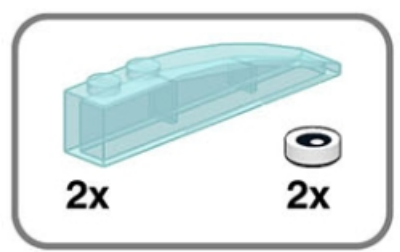

**40**

nerka@gmail.com

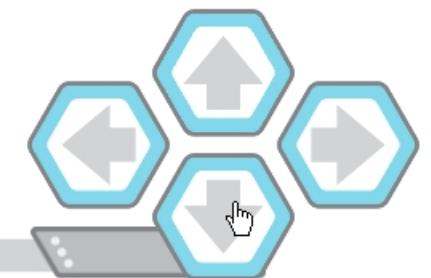
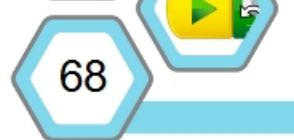
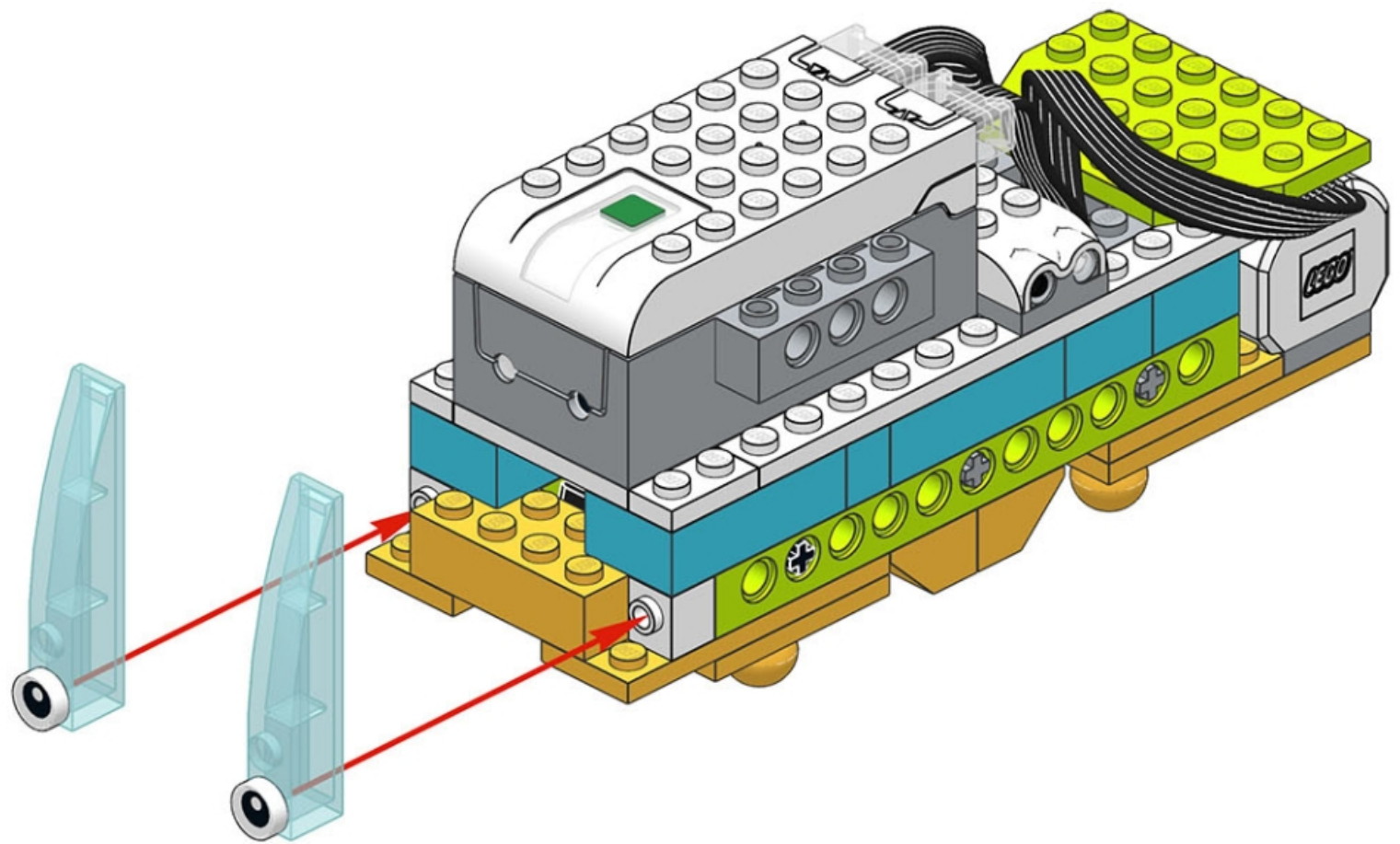

# 41

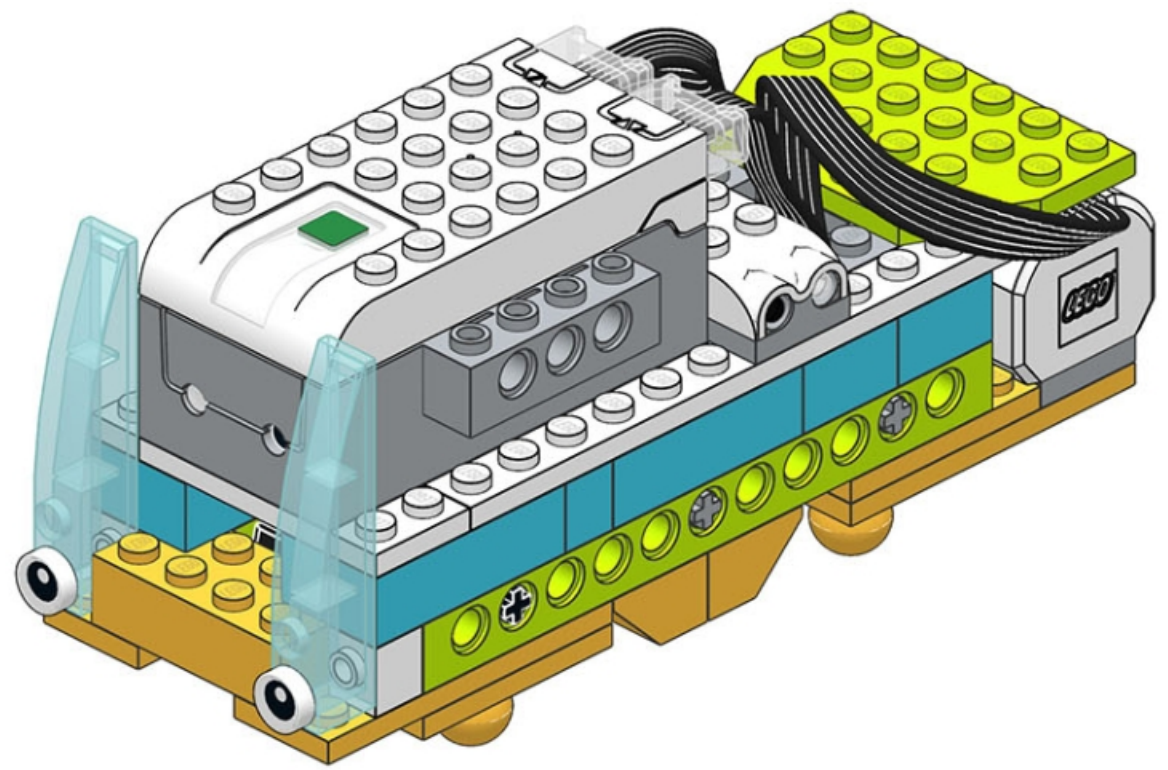

nerrka@gmail.com

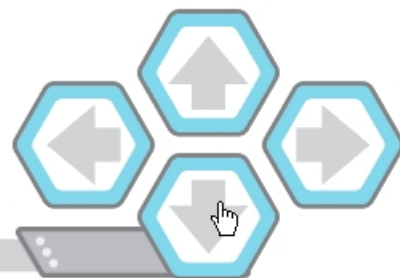



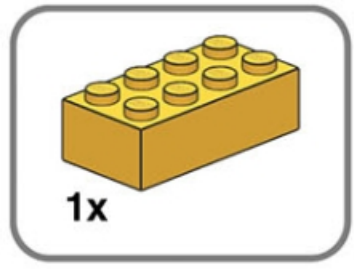

**43**

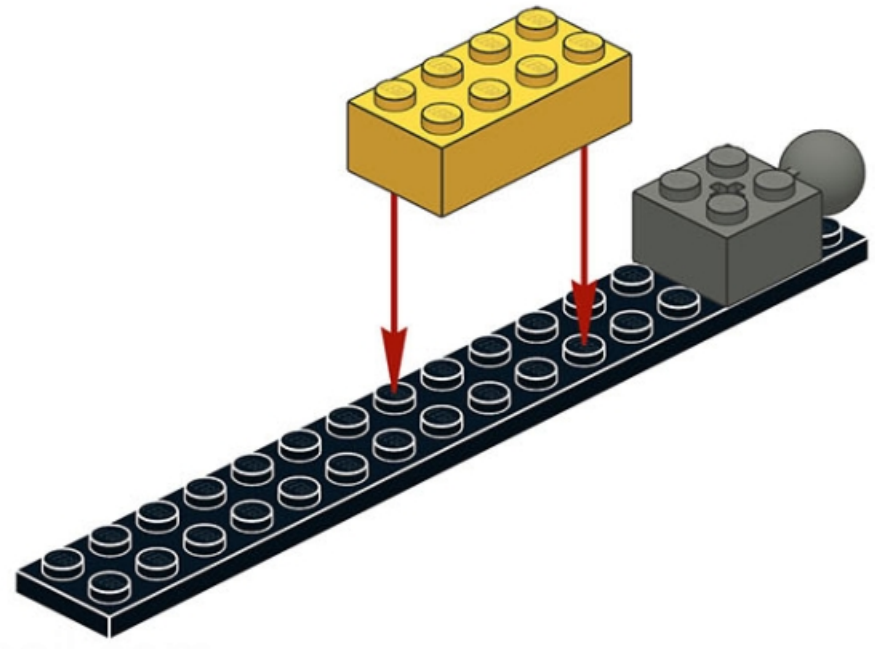

nerrka@gmail.com

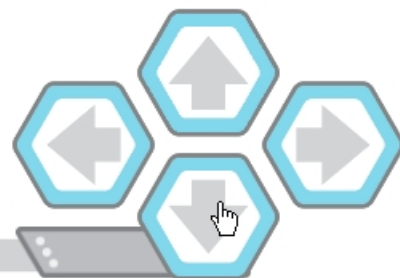

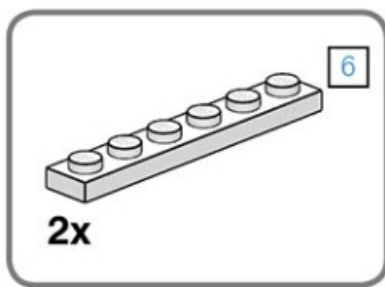

**44**

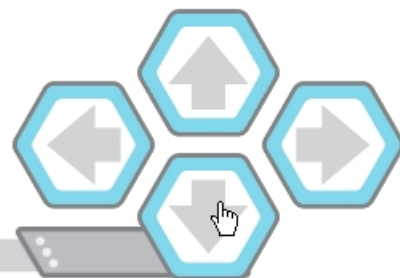
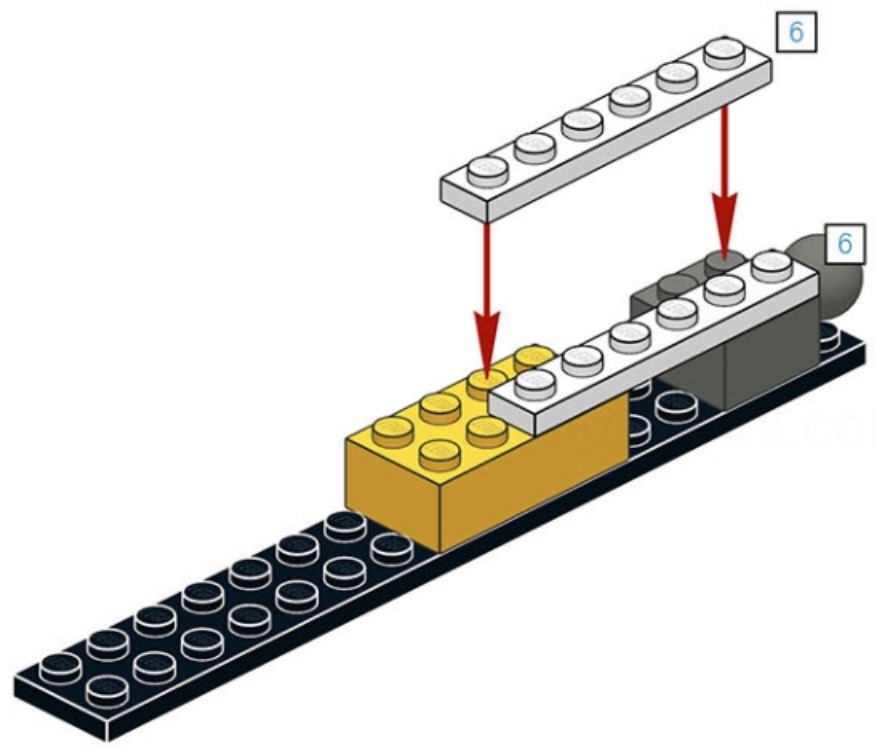

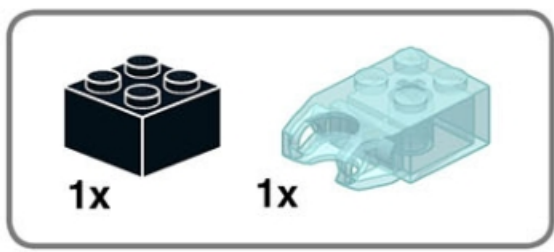

# 45

terka@gmail.com

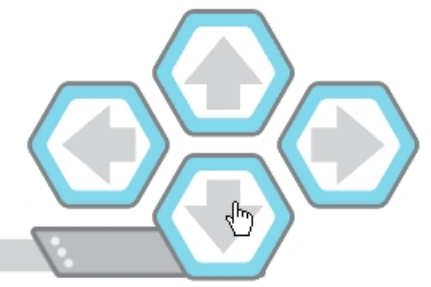
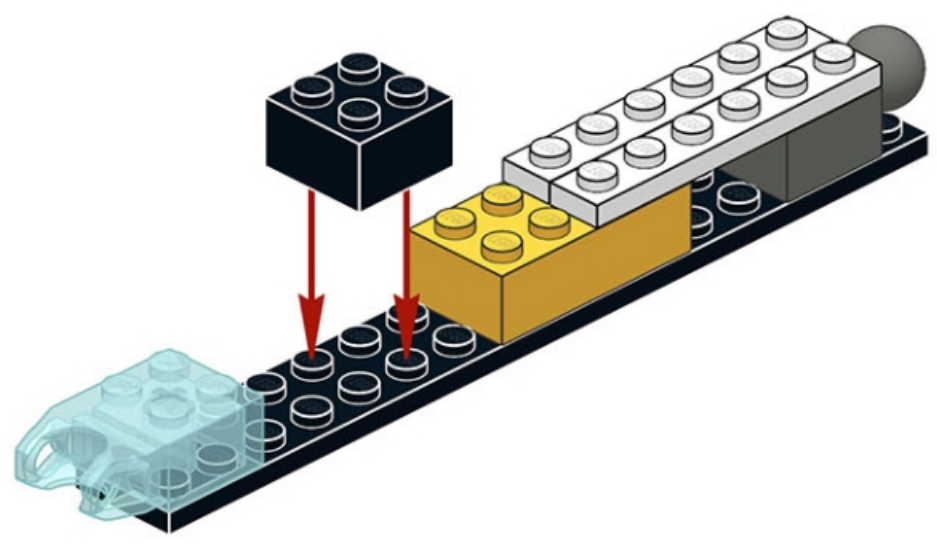

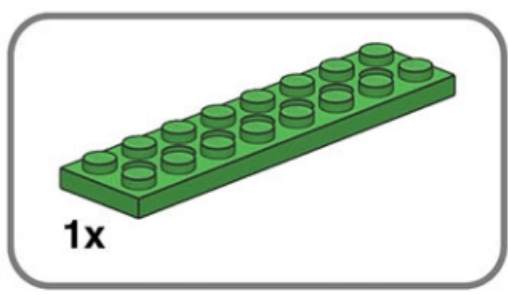

1x

**46**

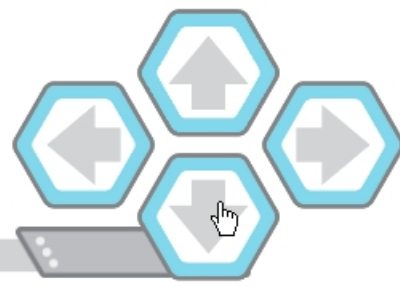
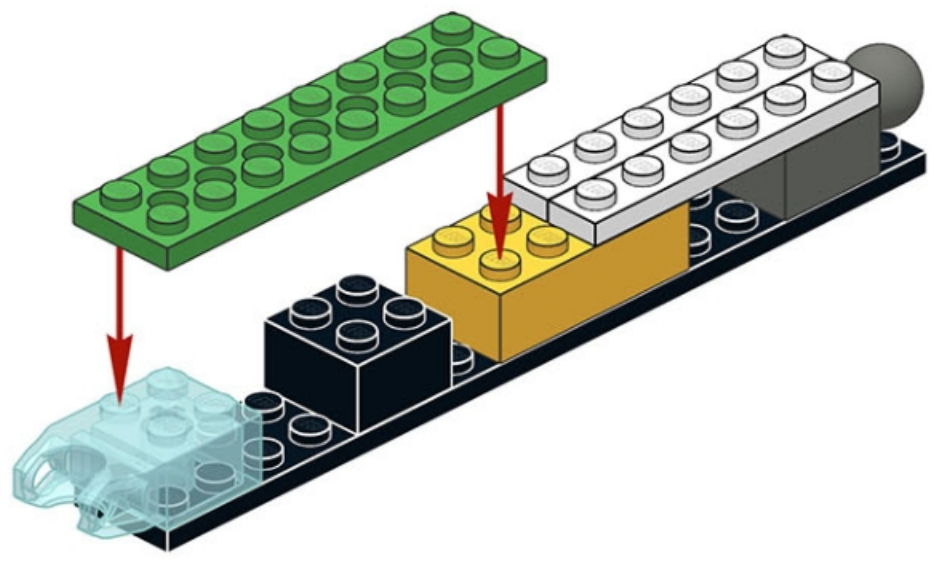

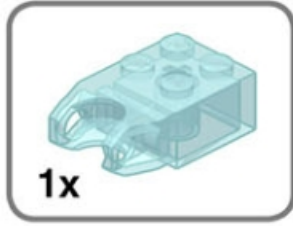

**47**

nerka@gmail.com

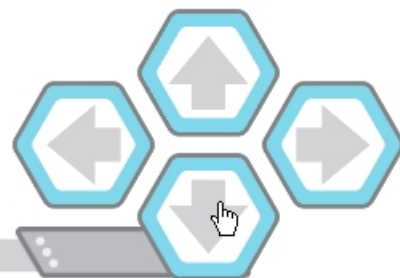
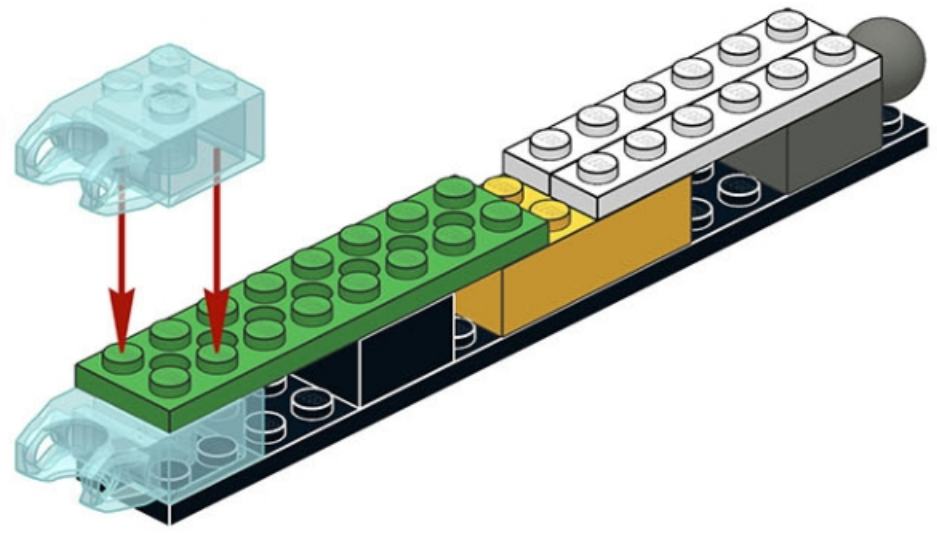



48

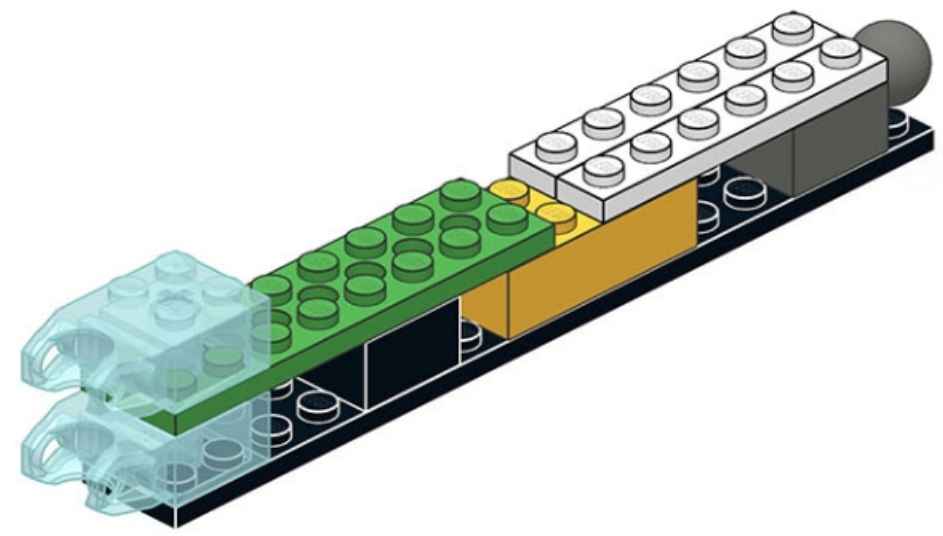

48/56

0



76

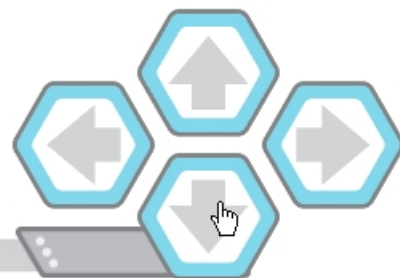

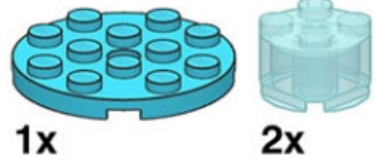

1

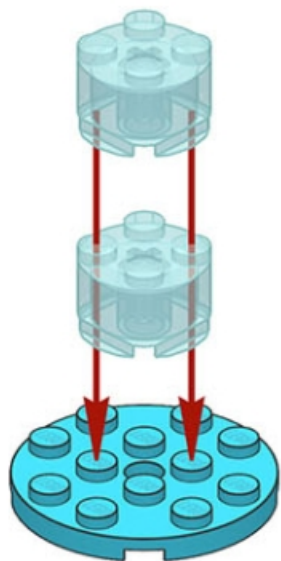

2

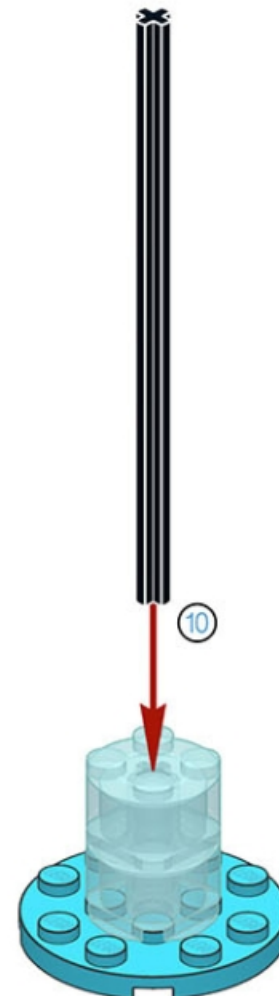

3



# 50

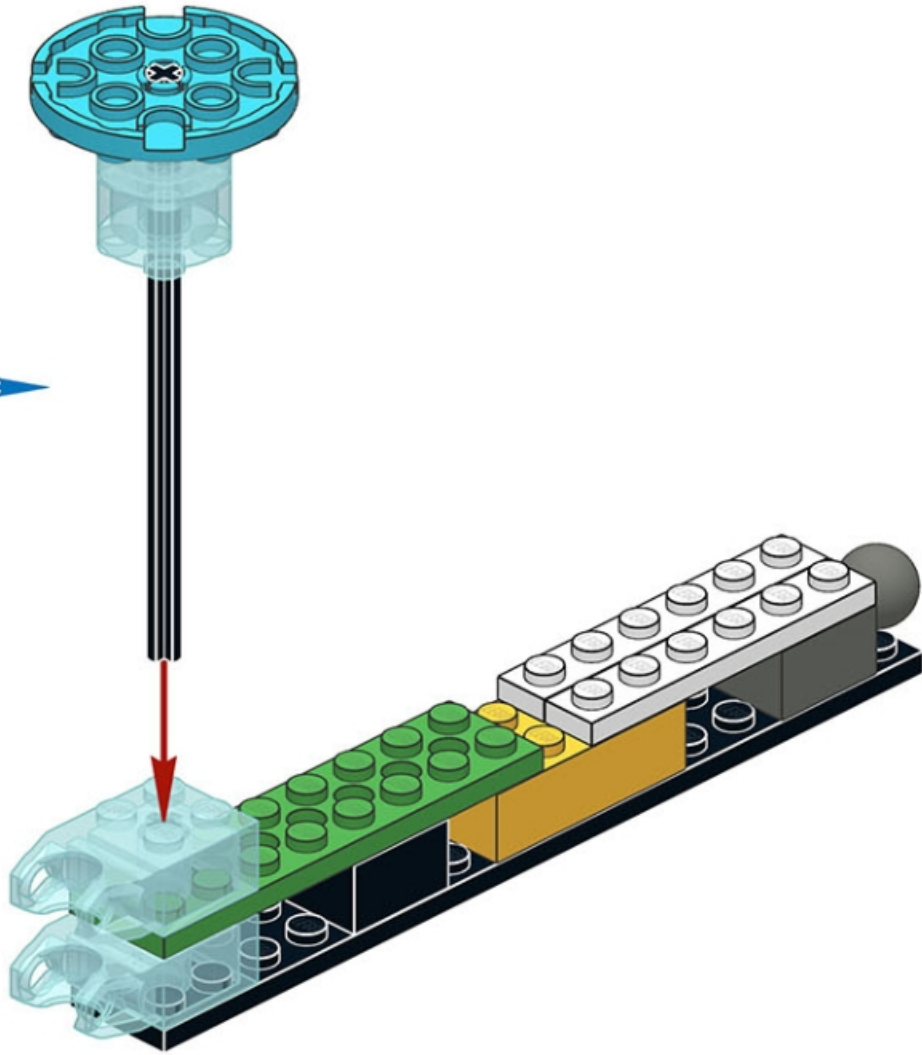

50/56

0

78

51

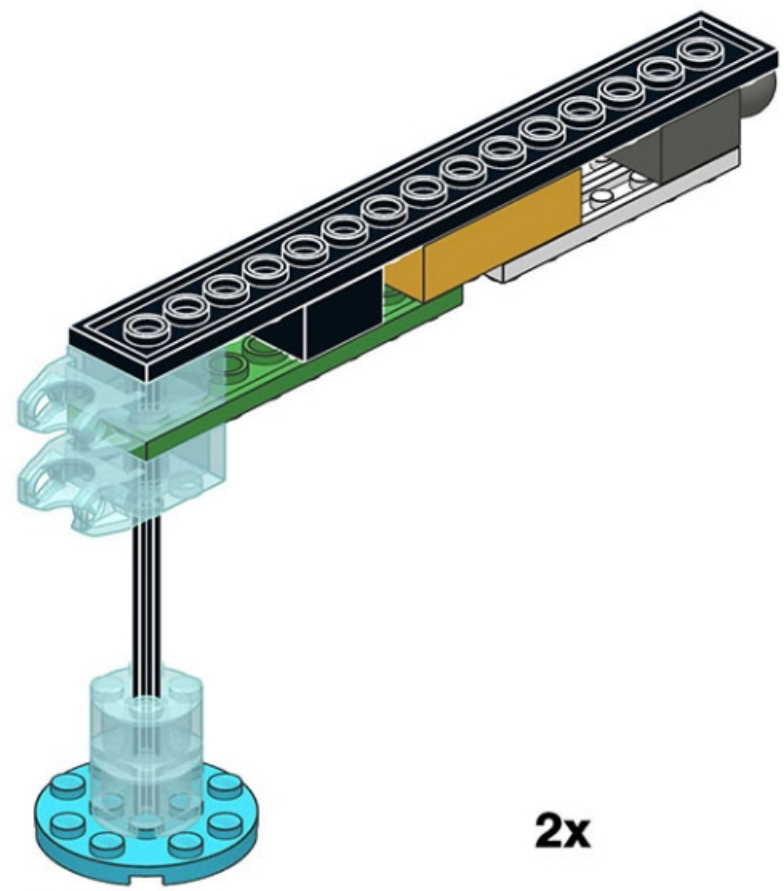

2x

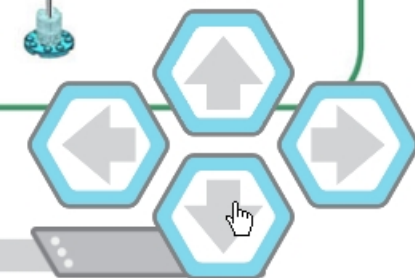
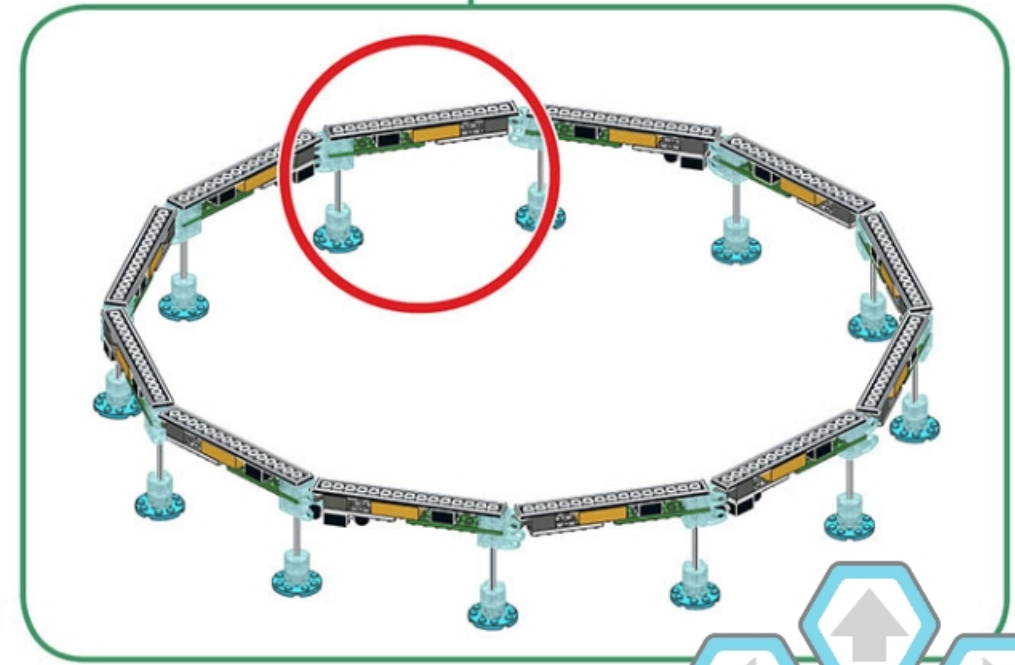

nerka@gmail.com

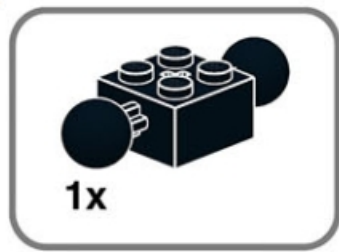

1

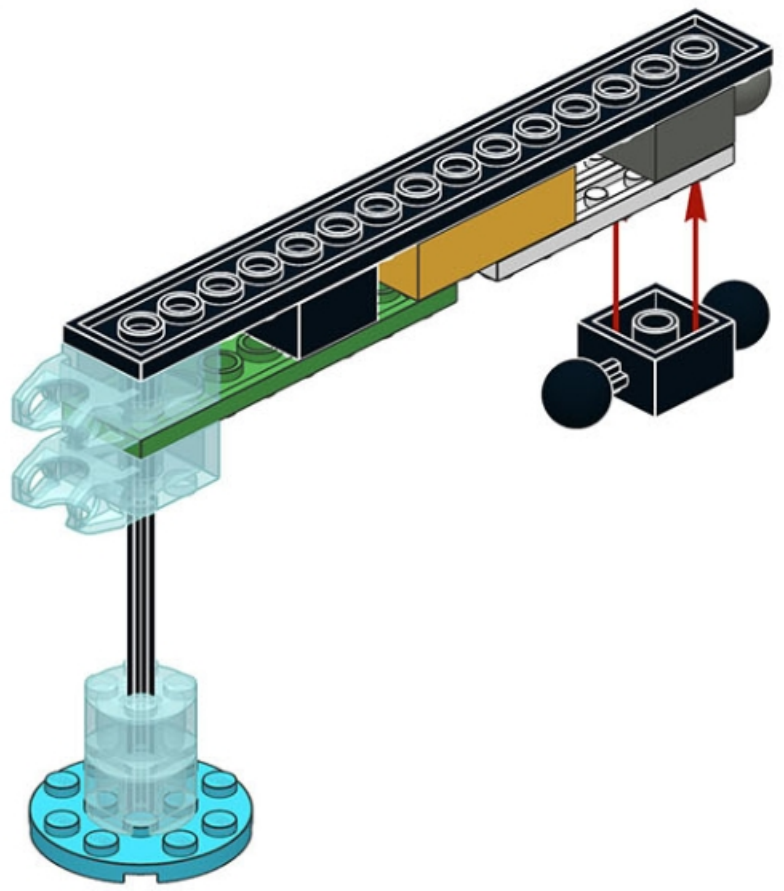

2

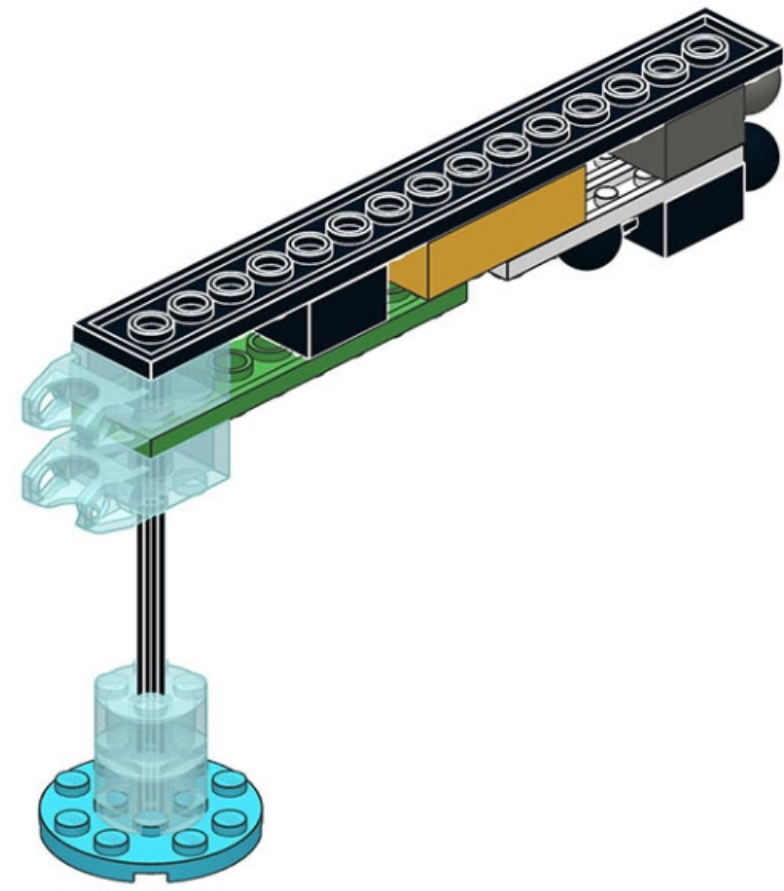

52/56



80



nerrka@gmail.com

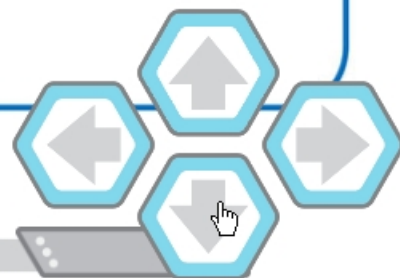

# 53

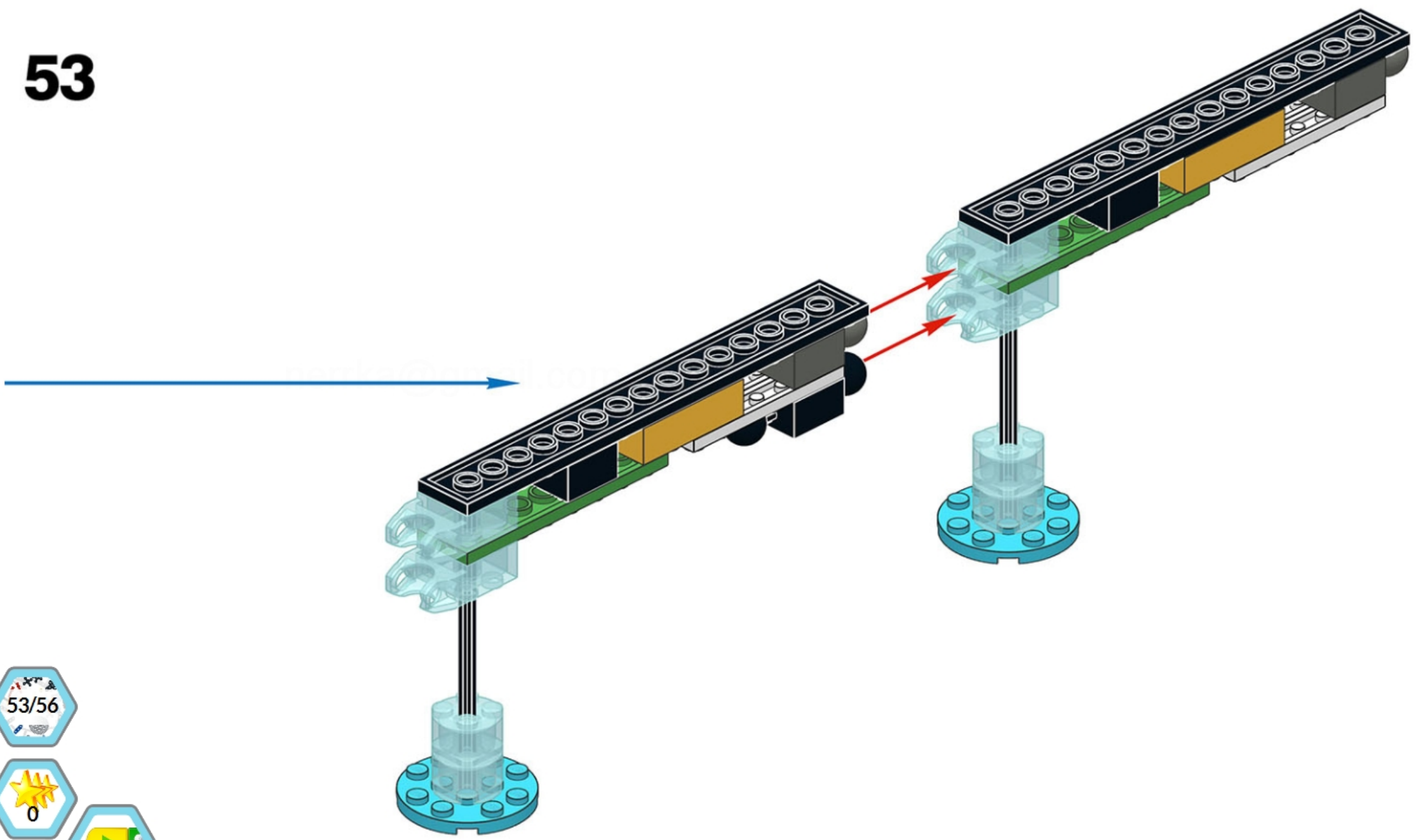

53/56

0

81

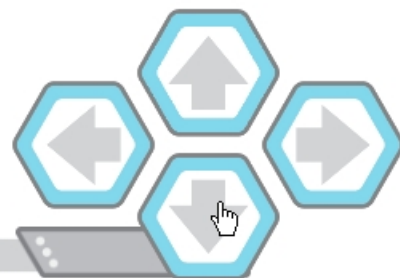

# 54

nerrka@gmail.com



54/56

0

82

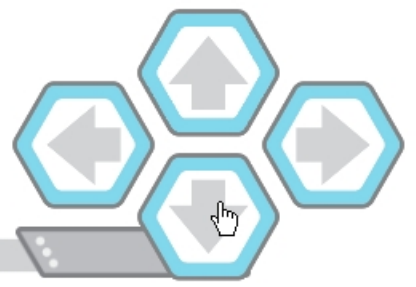

**55**

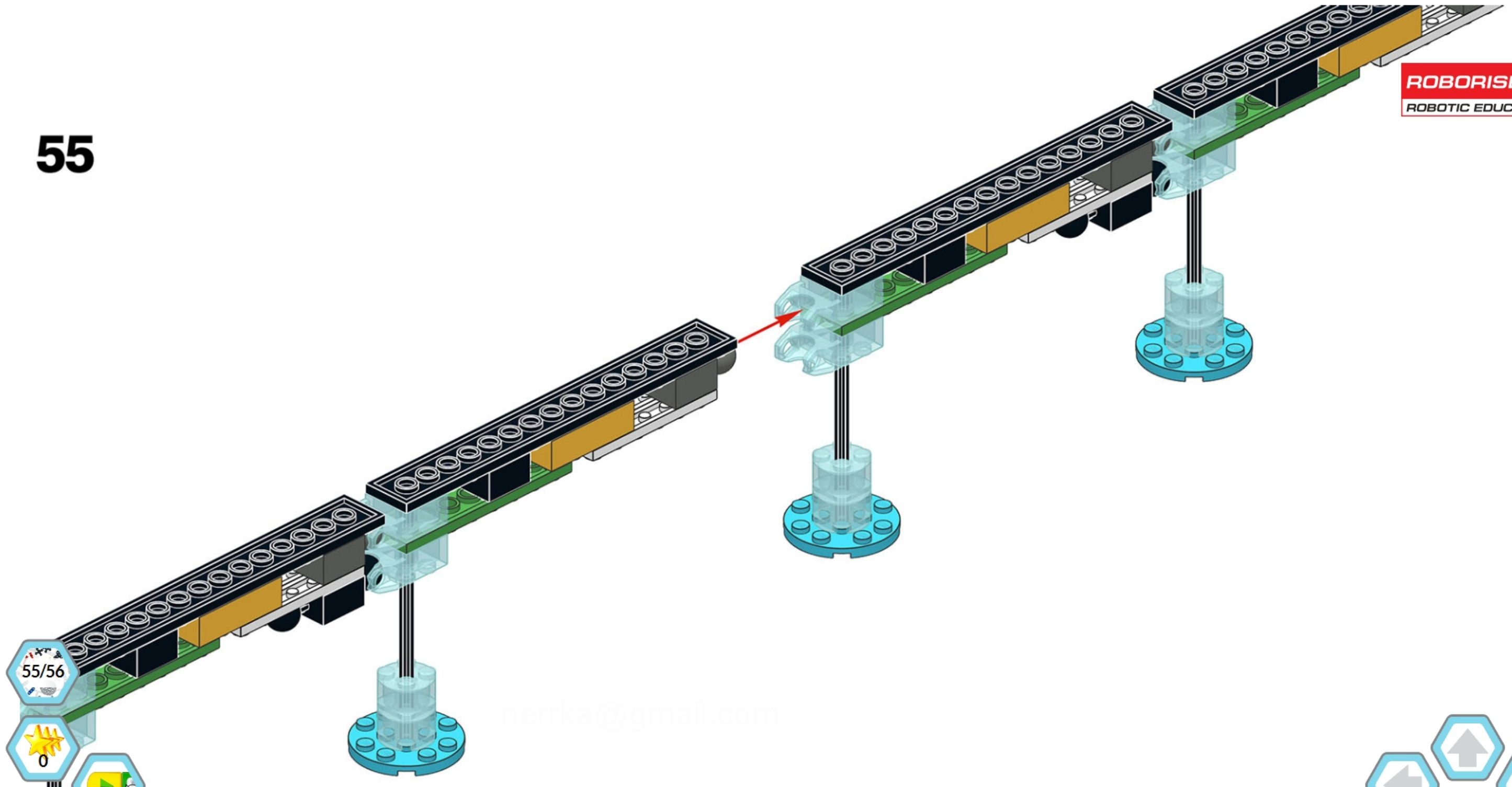

55/56

0

83

nerrka@gmail.com



# 56

nerka@gmail



56/56

0

84

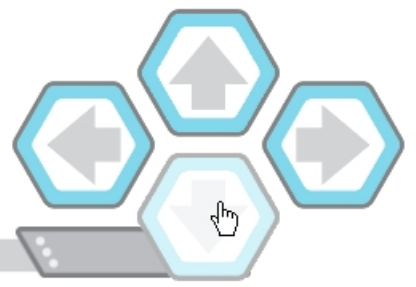



# Enhanced version

**ROBORISE-IT!**  
ROBOTIC EDUCATION

Build more comfortable  
train saloon.

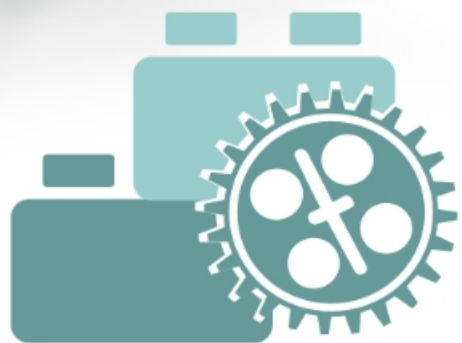
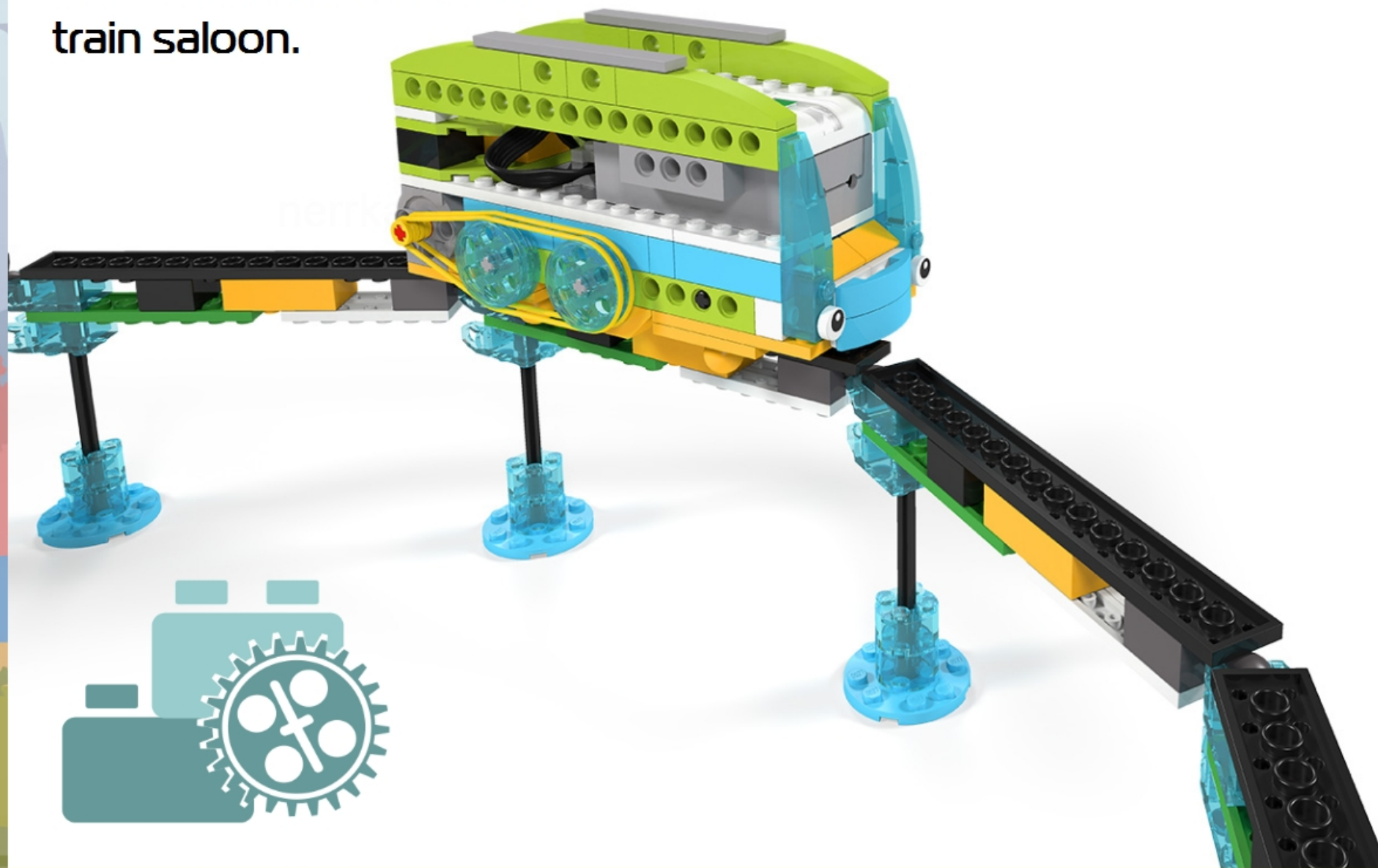

0



85



nerka@gmail.com

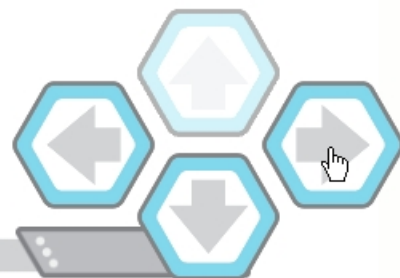
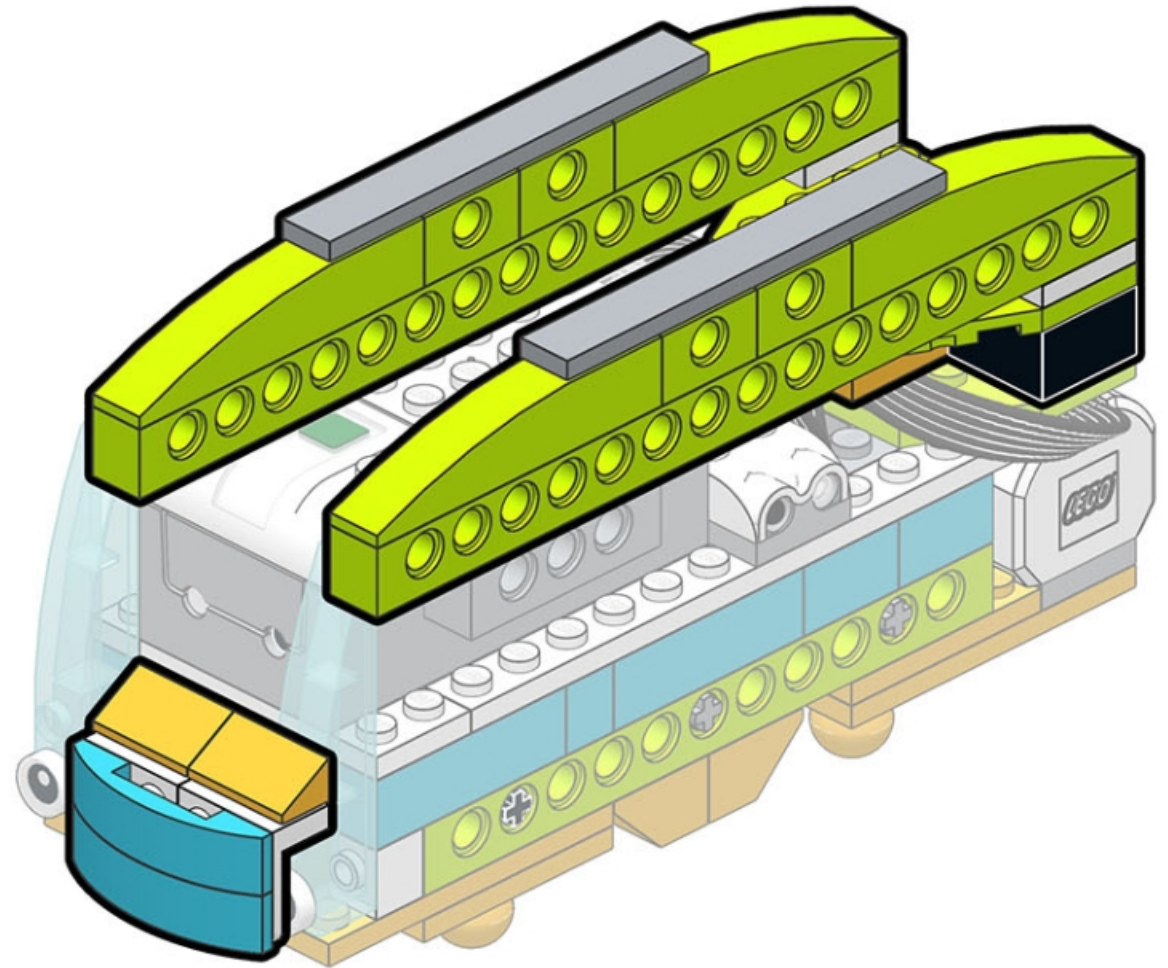

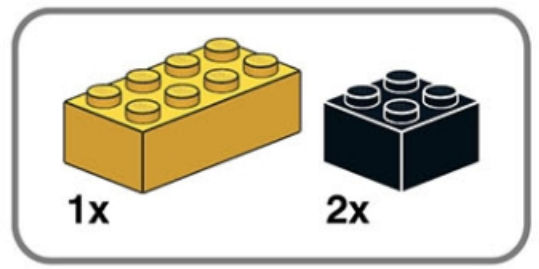

**57**

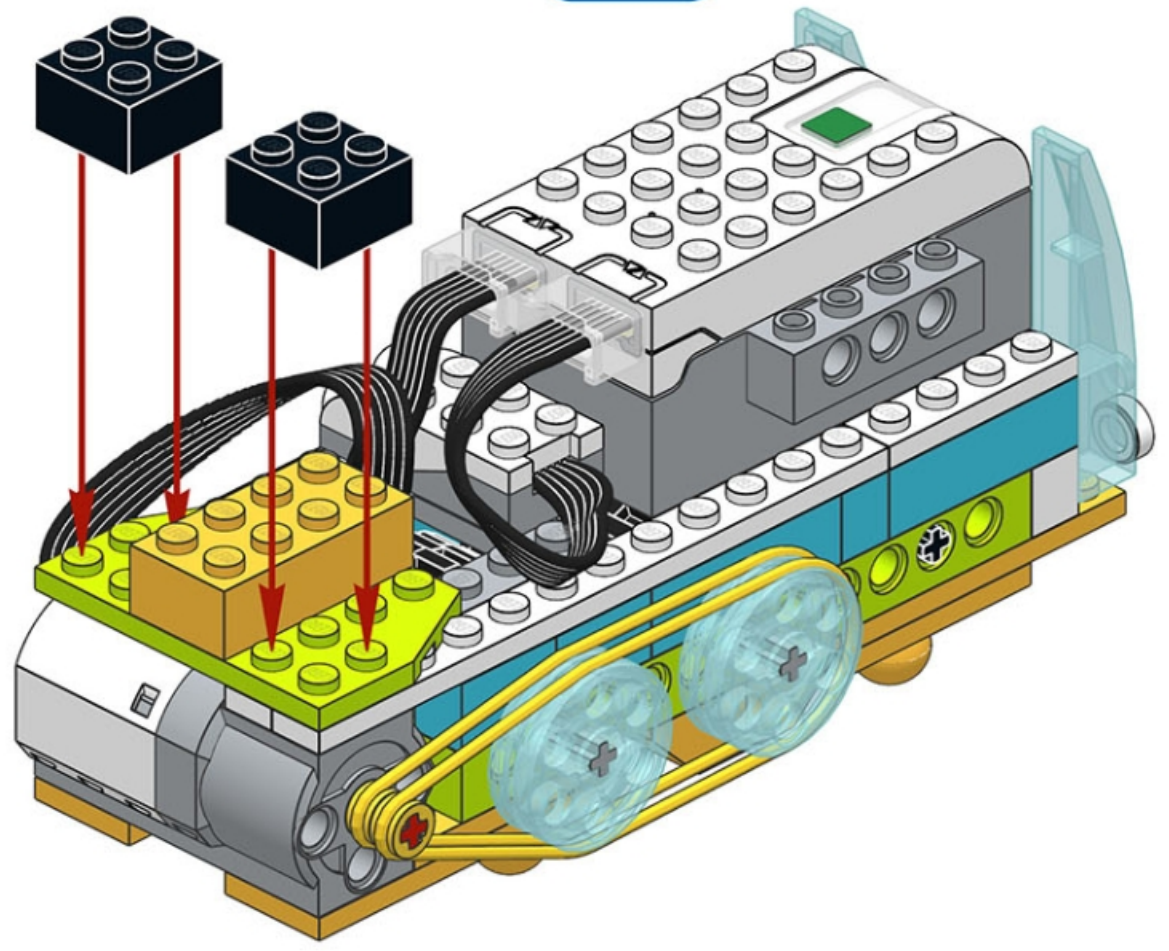

nerka@gmail.com

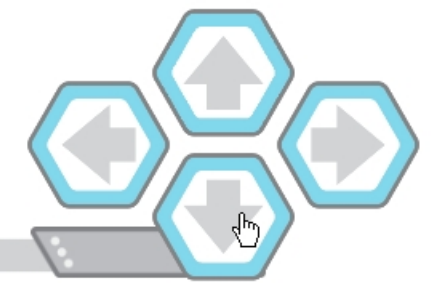

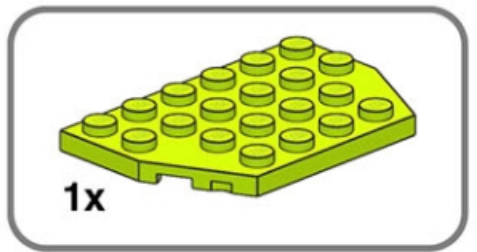

**58**

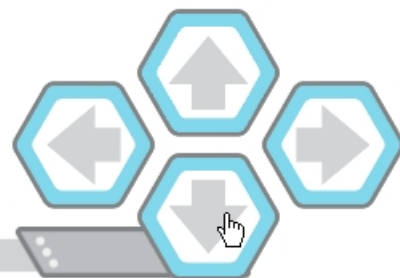
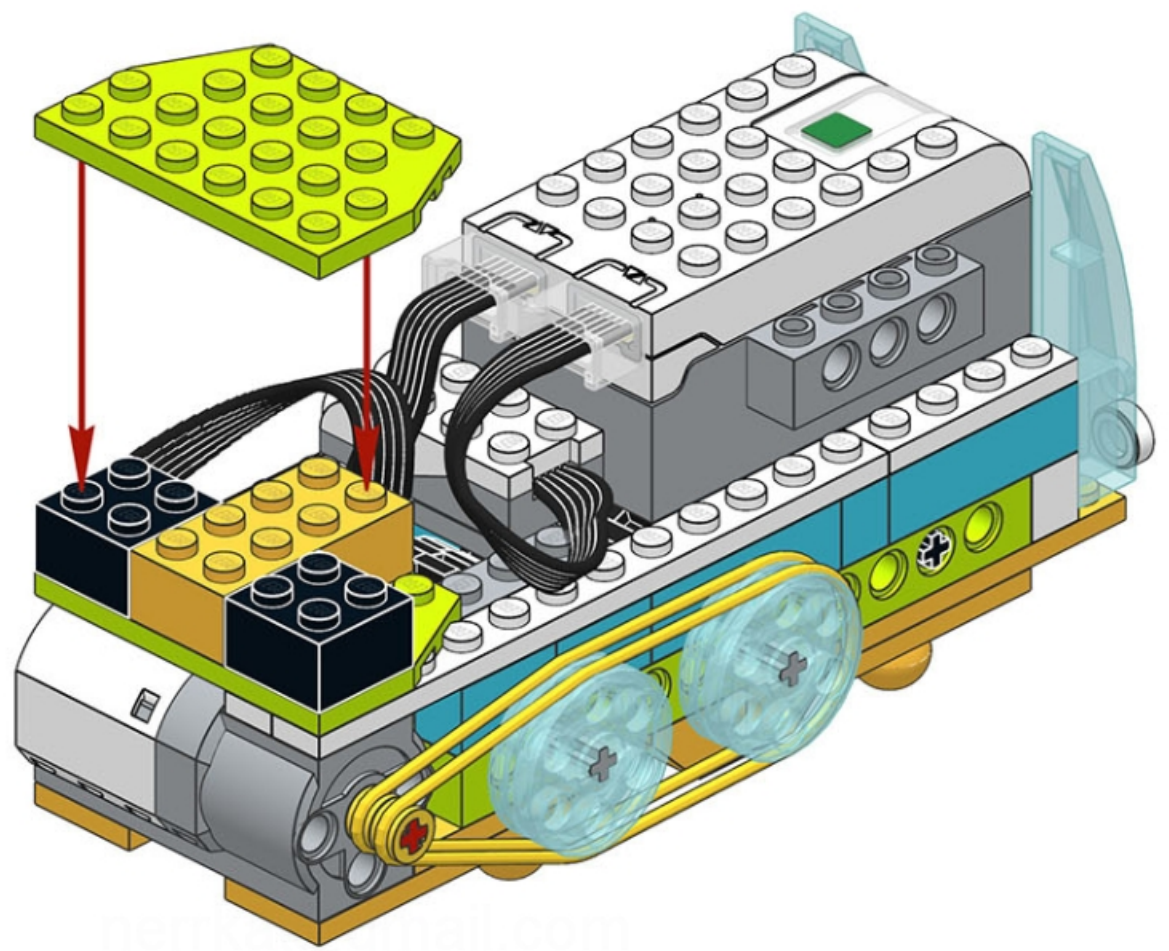

# 59

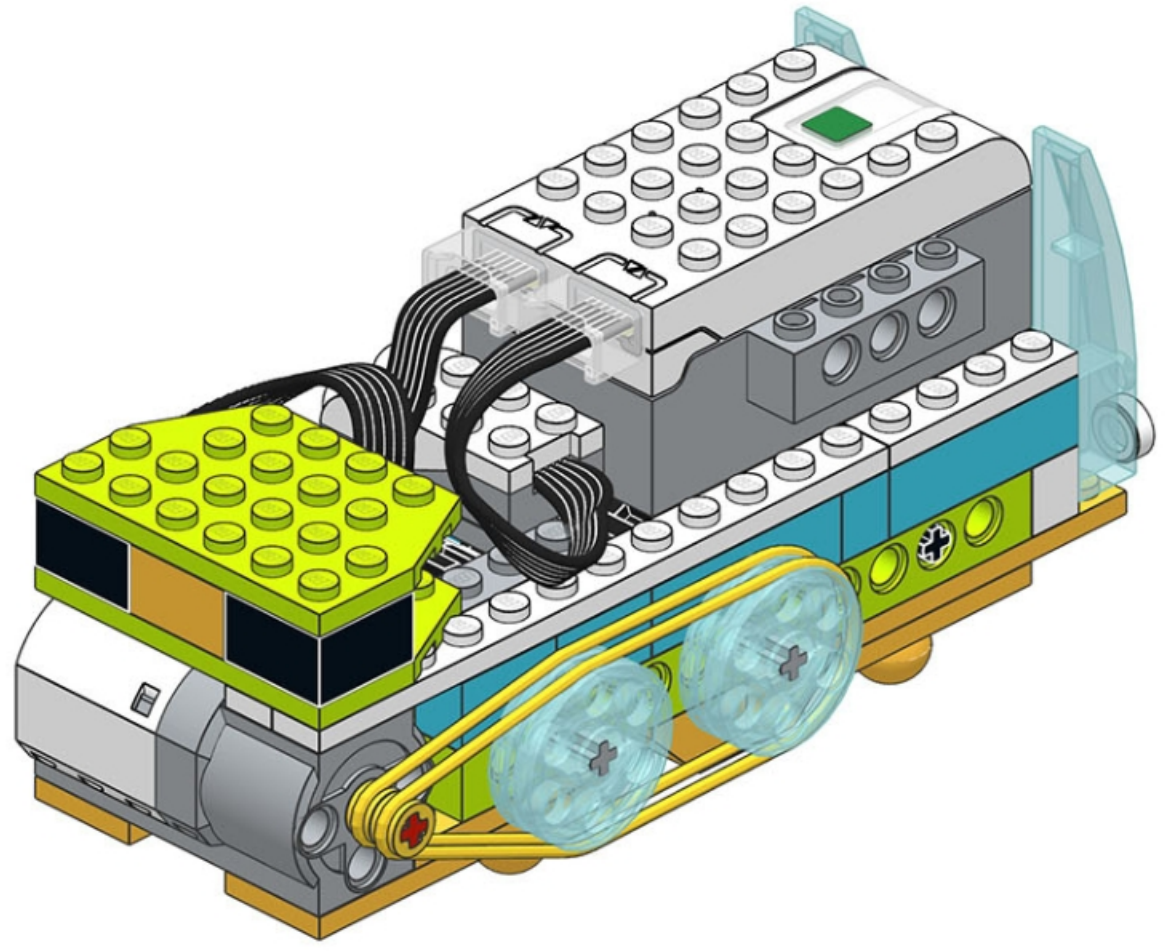

nerka@gmail.com

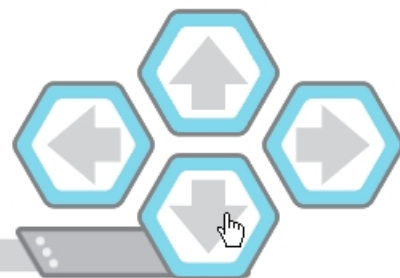

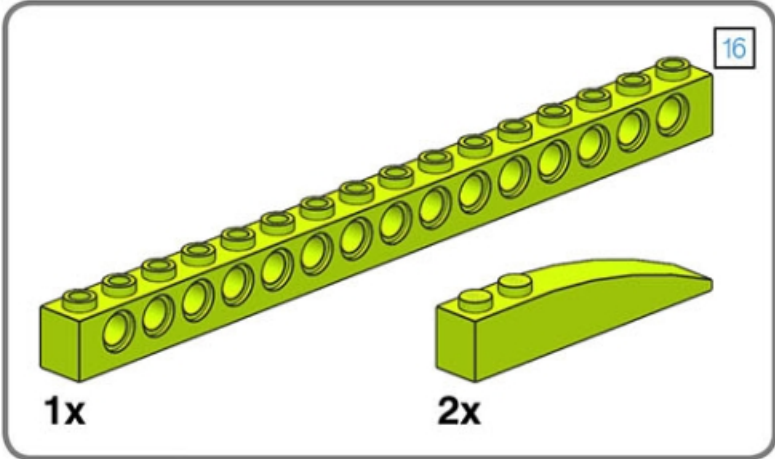

1

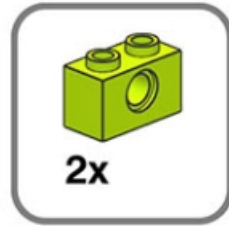
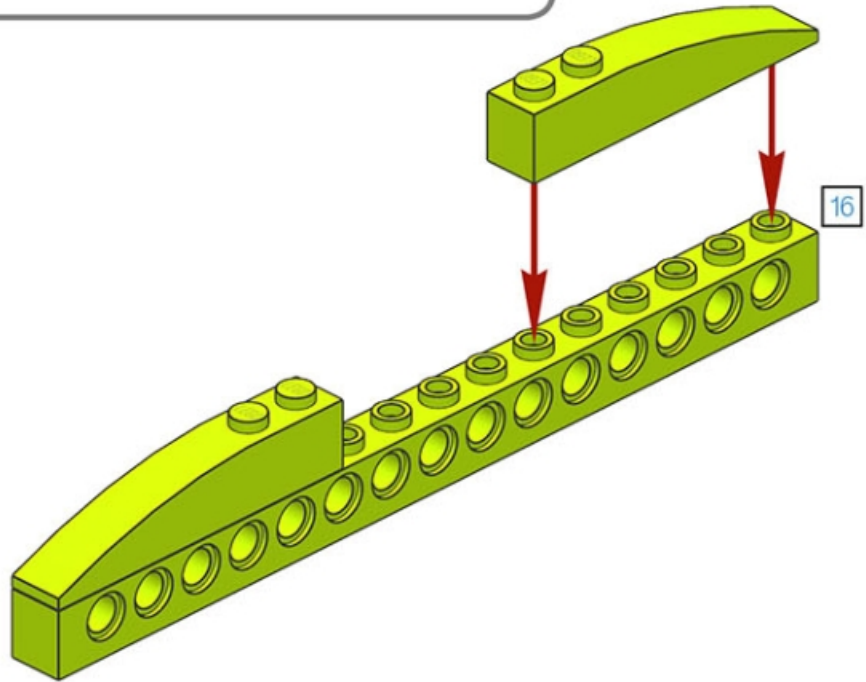

2

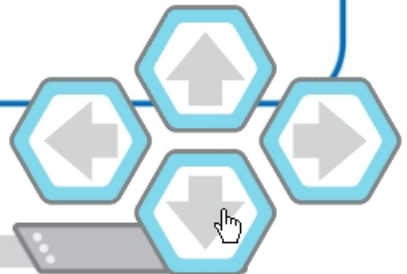
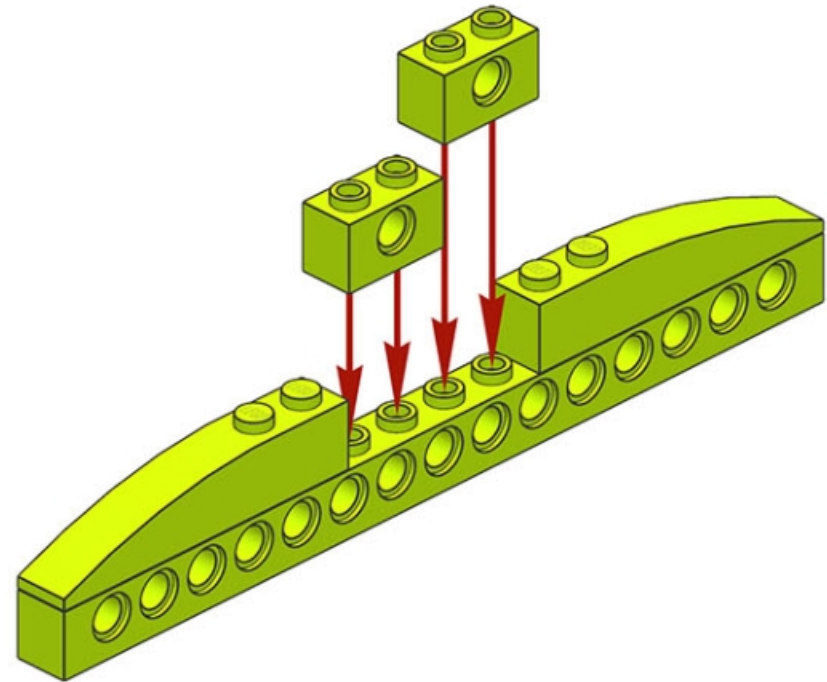

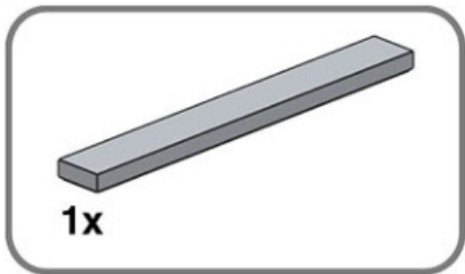

3

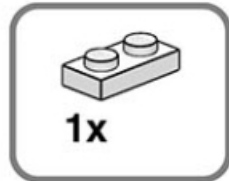
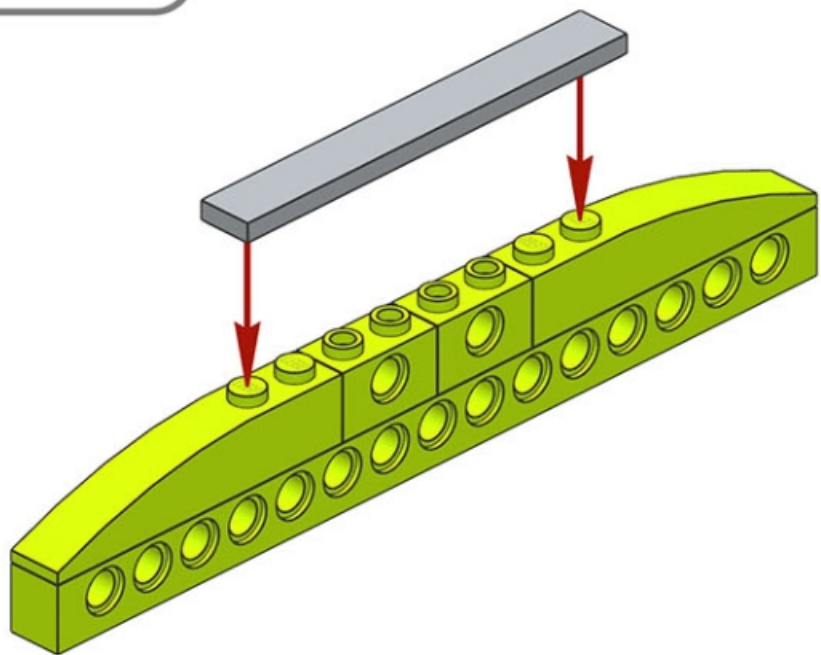

4

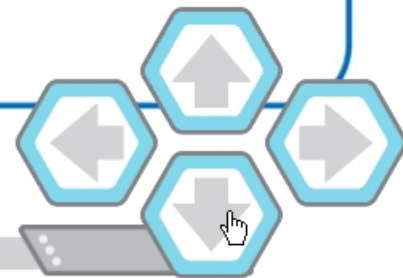
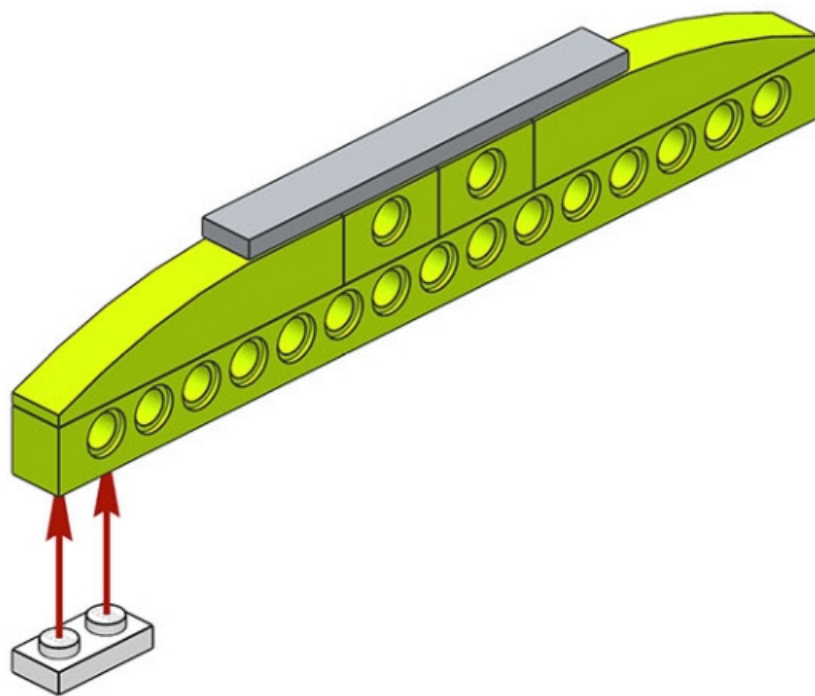



**5**

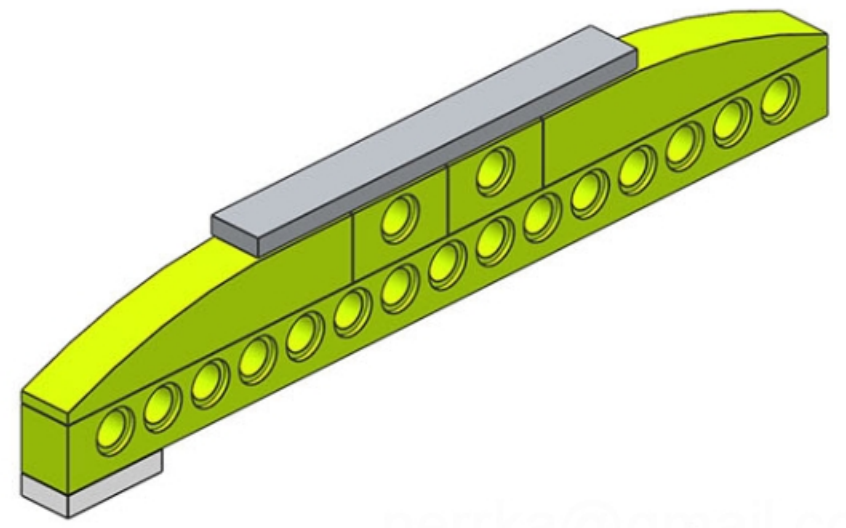

**2x**

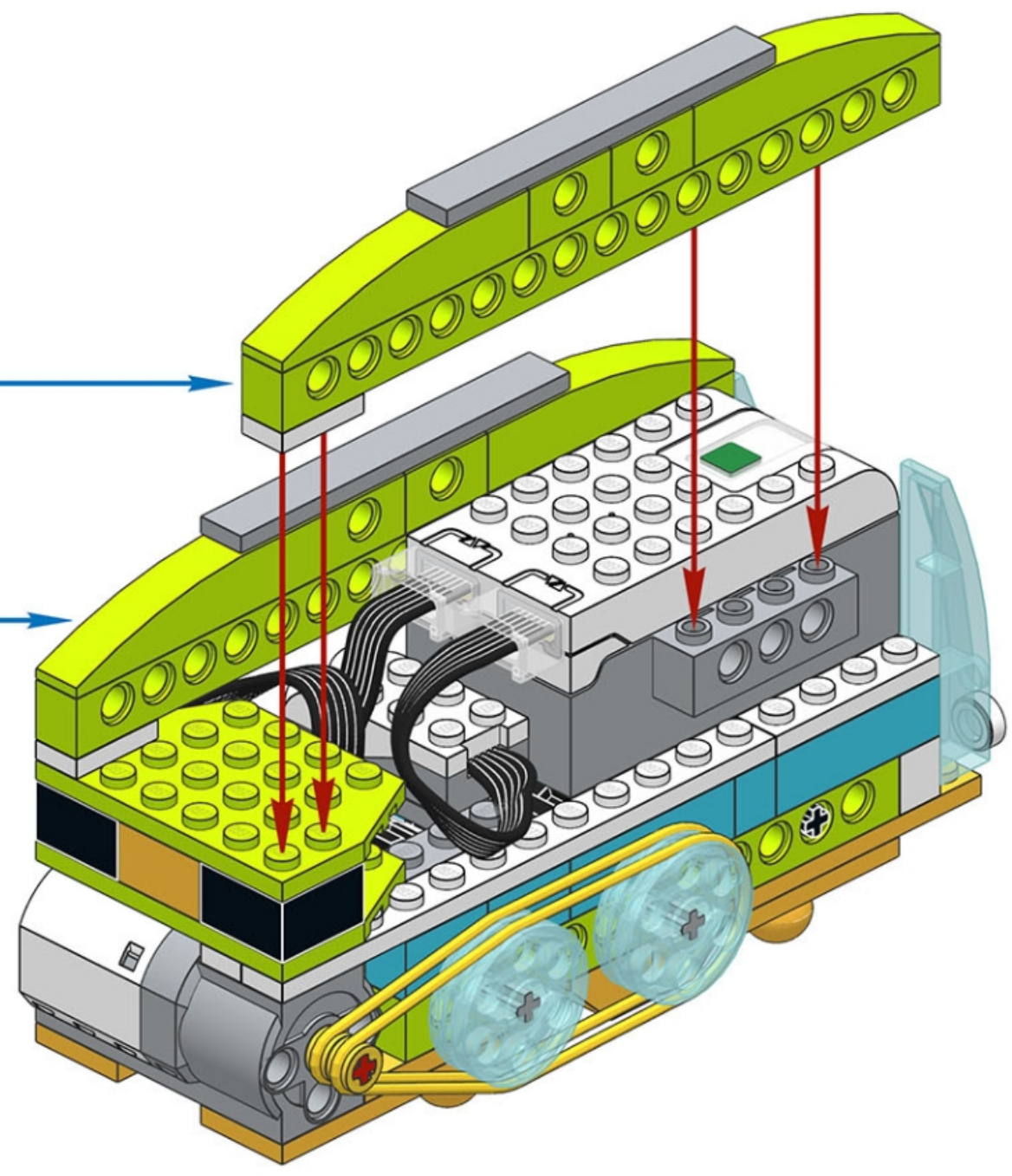

7/12

0

92

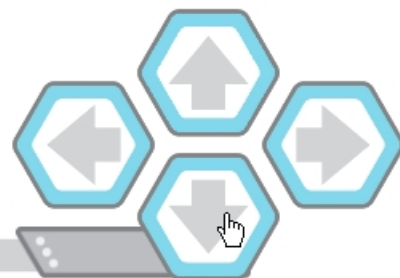

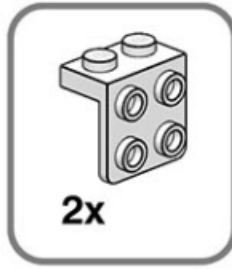

# 63

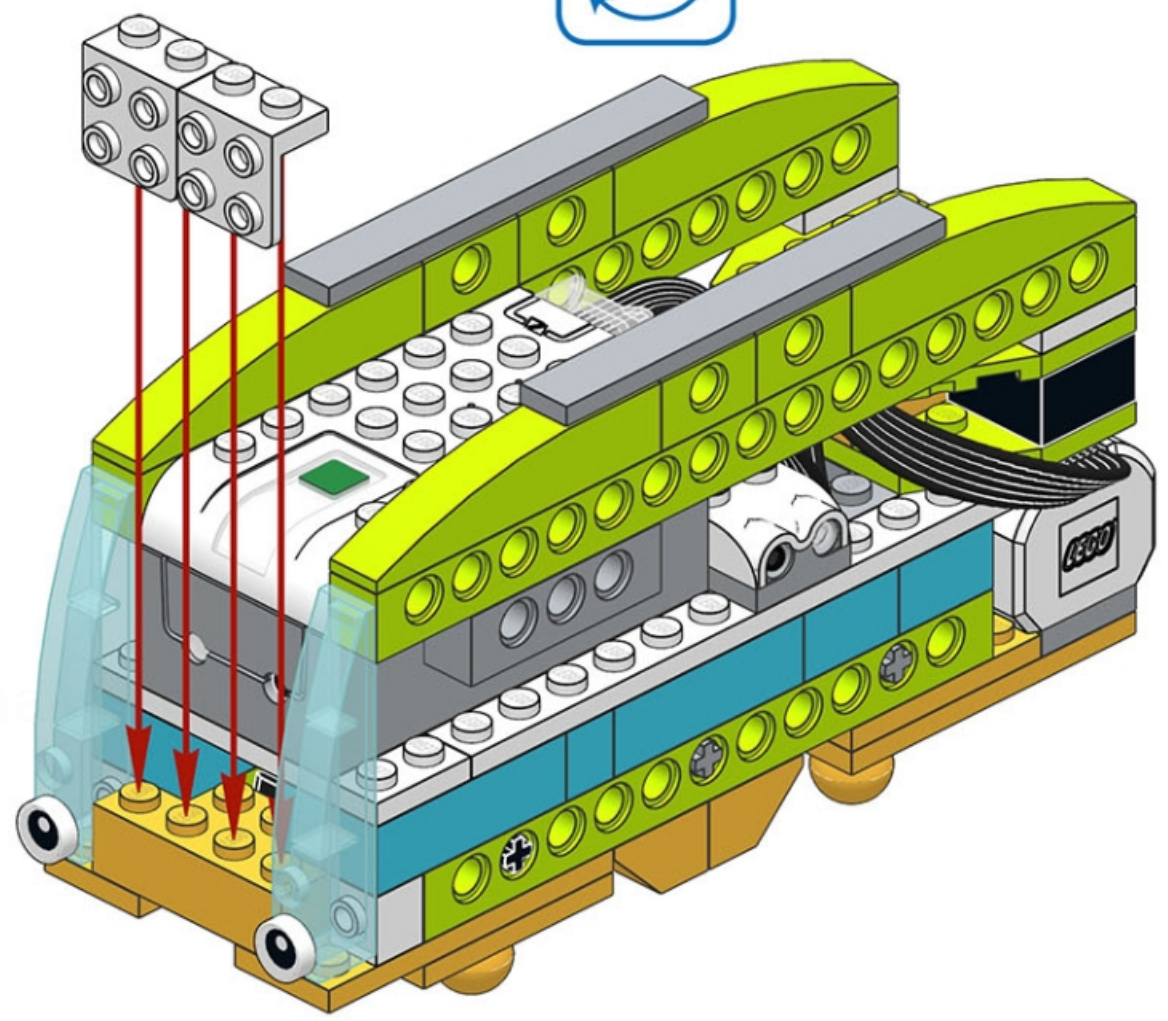

nerka@gmail.com

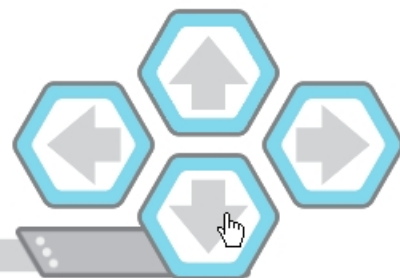

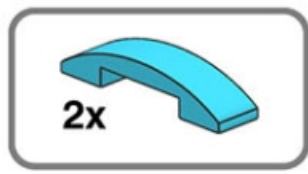

**64**

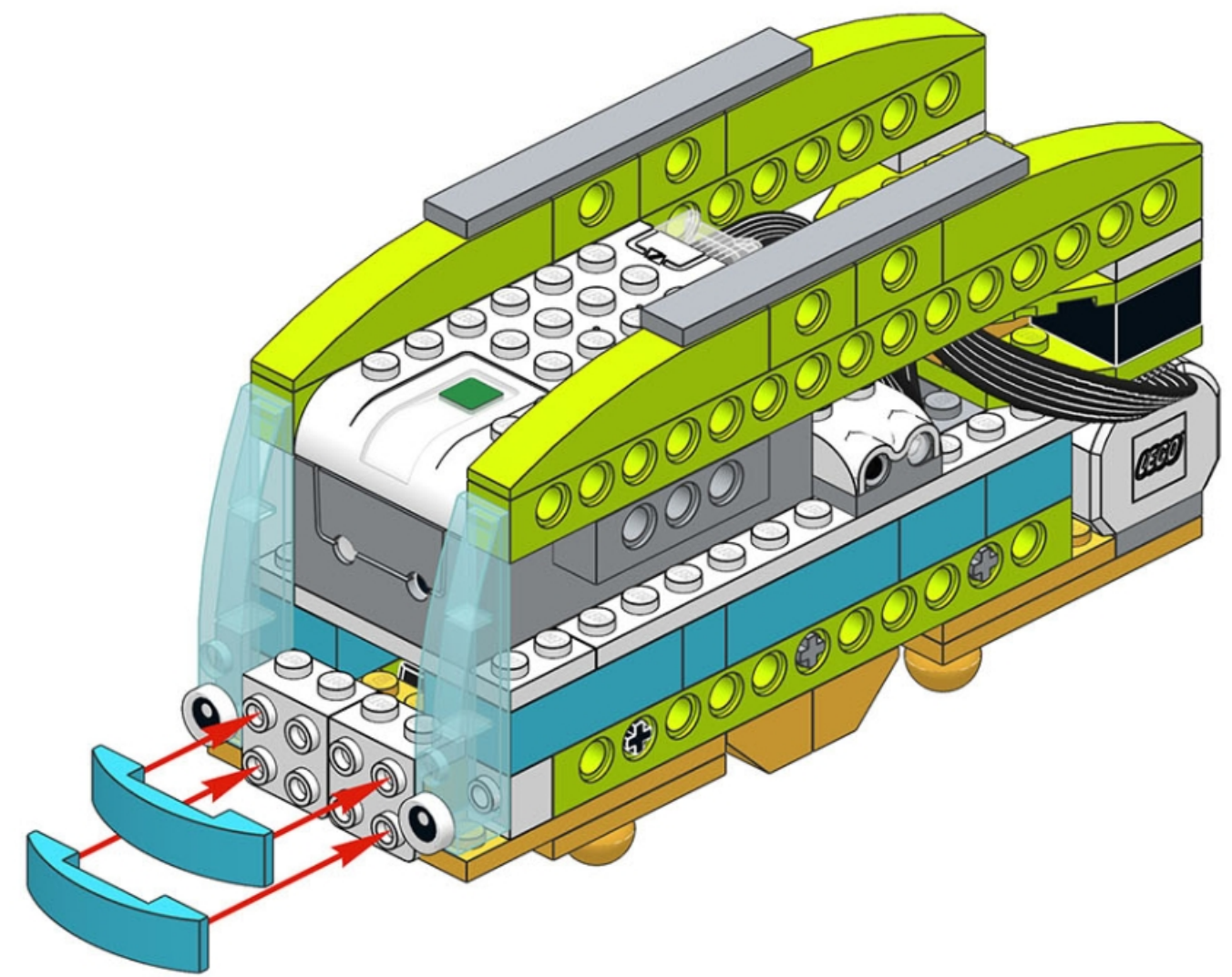

nerka@gmail.com

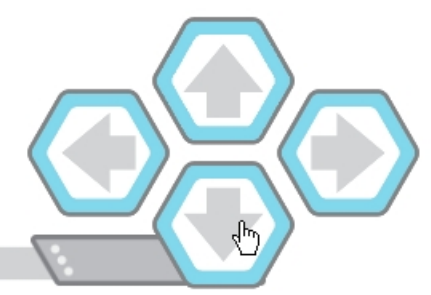

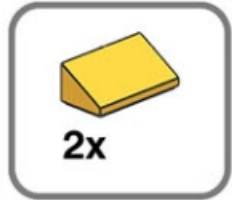

65

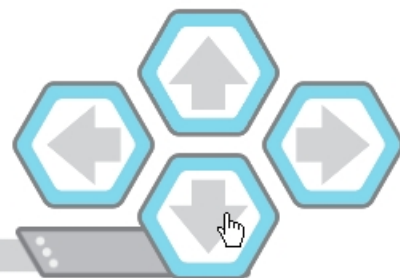
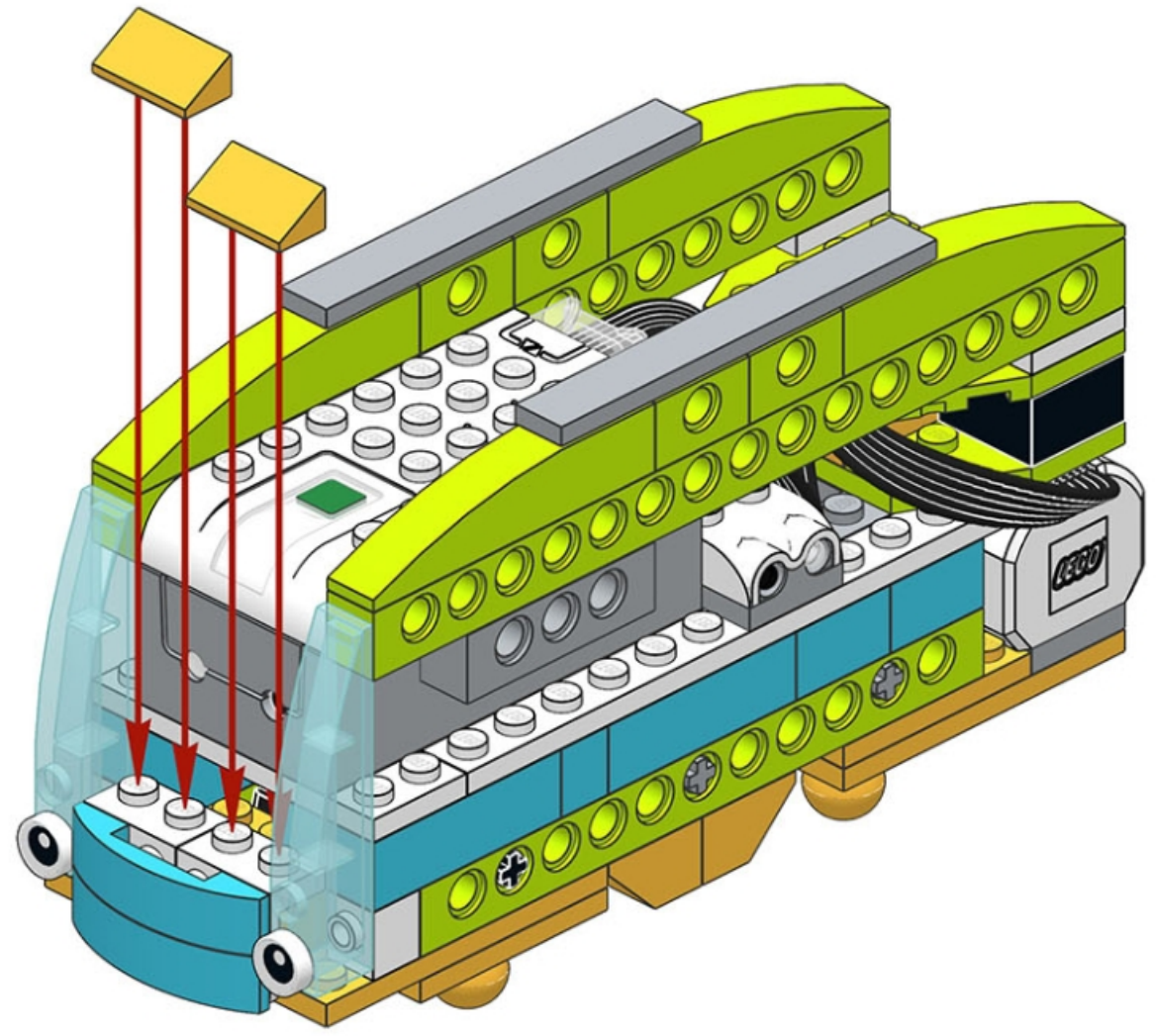

66

@gmail.com

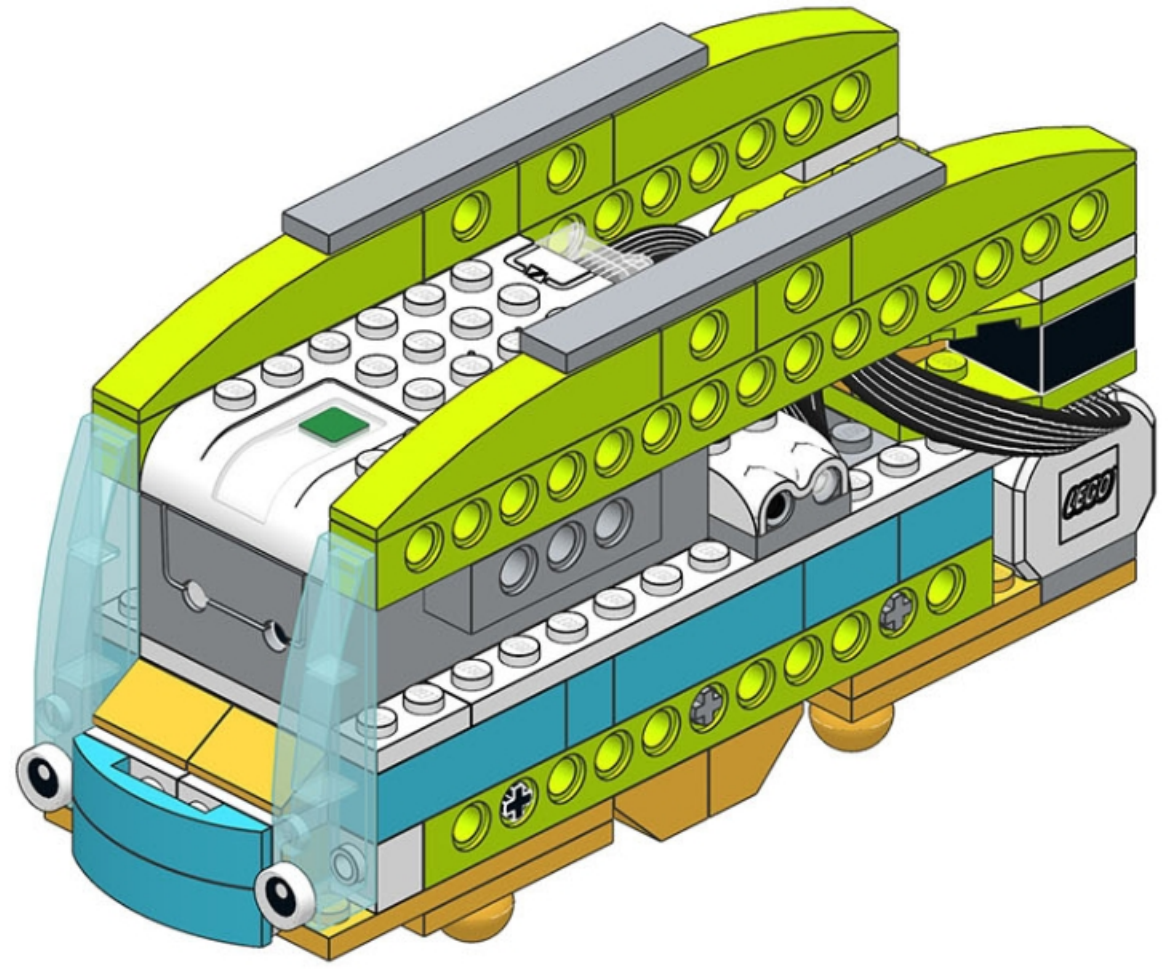

11/12

0

96

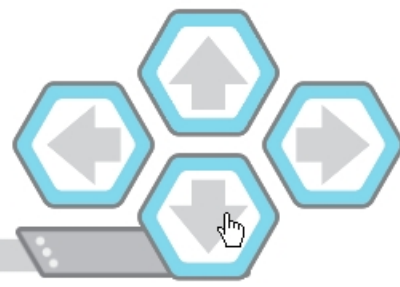

67

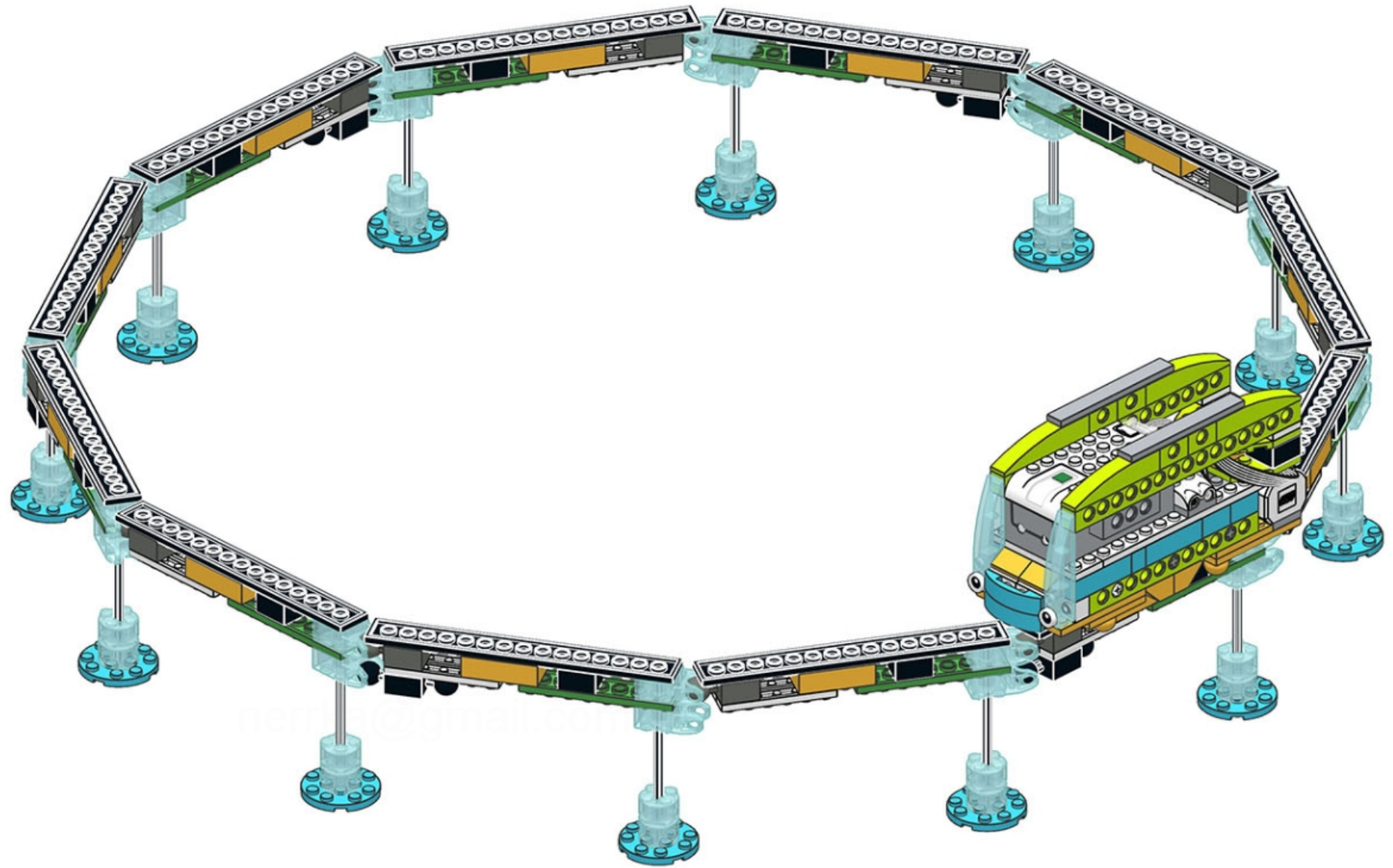

12/12

0

97

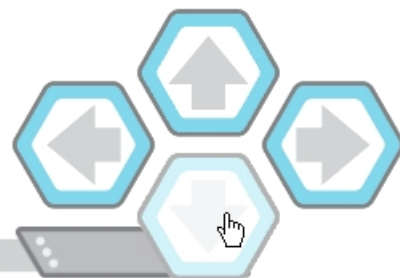



# MonoRail

**ROBORISE-IT!**  
ROBOTIC EDUCATION



## MonoRail





# New day at the robots` factory

ROBORISE-IT!  
ROBOTIC EDUCATION



Hello!  
Our next task is to solve the problems of public transport system. A large number of tourists are expected. The city must be ready to provide the free movement of people.

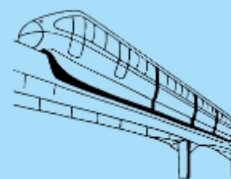





# TASK



## TASK

- to find the solution of the public transport system problems



## Steps

- to know more about the types of public transport
- to define the main advantages and disadvantages of the each transport
- to make the choice of the transport to build



0



4

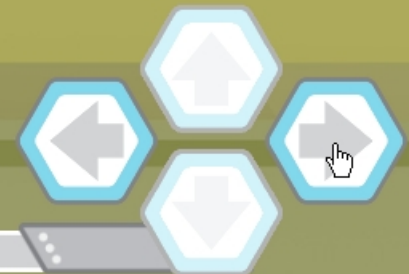



# Discussion of the task



What do you know about the public transport? What types of it do you know?





# Public transport

Public transport helps to make the free movement of people between city districts. Usually the working and living places are separated, so people need to travel to the job.

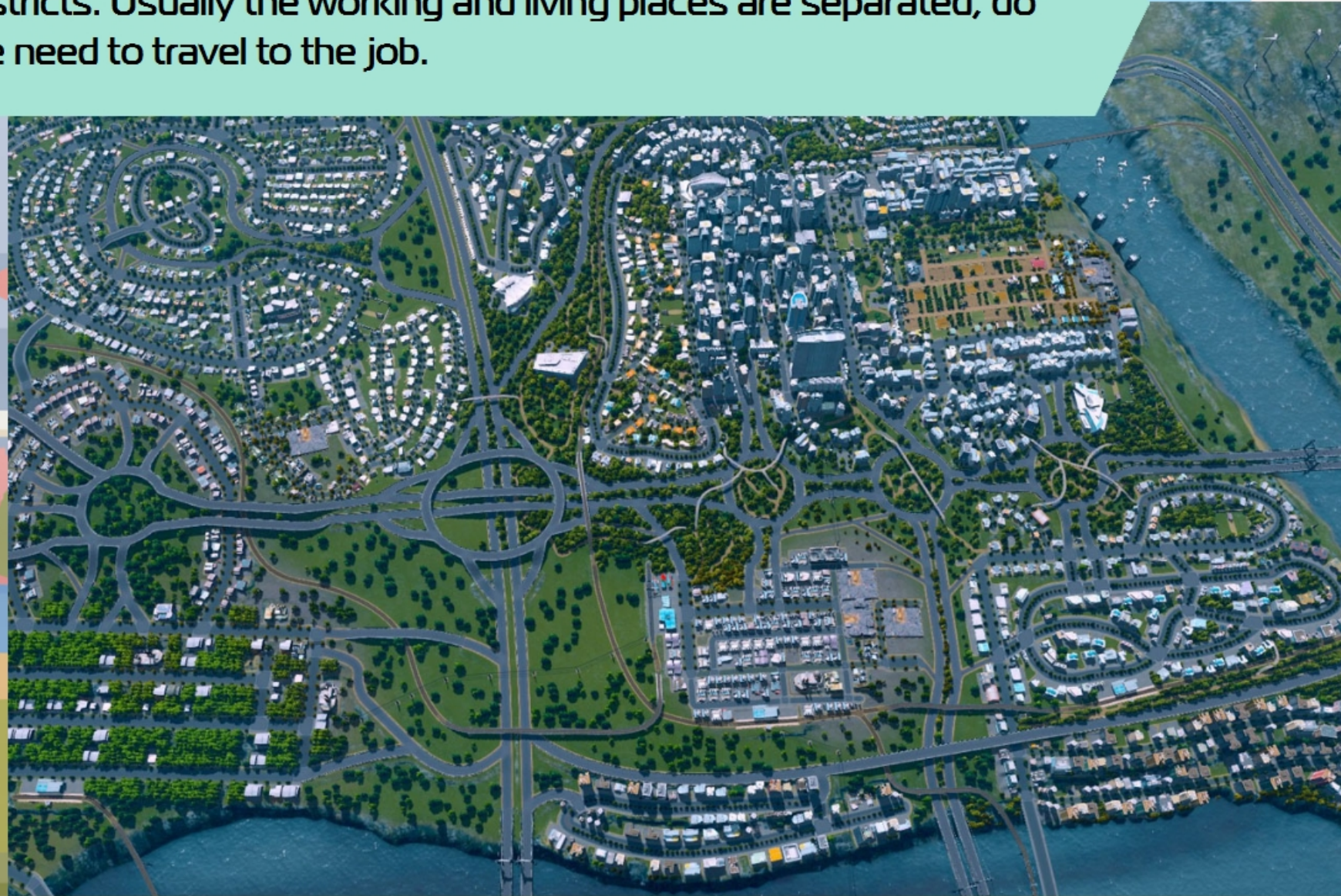

0



6





# Public transport

The good functioning of the public transport system decrease the number of the cars on the roads and allows to travel faster.





# Public transport types

There are a lot of the factors that may be used for the grouping the transport to the types. But one of the main is the power source. In this layer the transport may be grouped to the electric type and the petroleum/gas type.



0





# Discuss!



How do you think, what advantages of the electric public transport has?





# Electric public transport @gmail.com

ROBORISE-IT!  
ROBOTIC EDUCATION

The following machines is electric: trolleybus, tram, metro, monorail.  
Also the electric-powered buses appears on the roads of many countries.



0



10





# Electric transport advantages

**ROBORISE-IT!**  
ROBOTIC EDUCATION

Electric public transport decreases the air pollution emissions in cities. Also it produce minimal noise pollution and may be use in the enclosed space (in tunnels or underground).



11

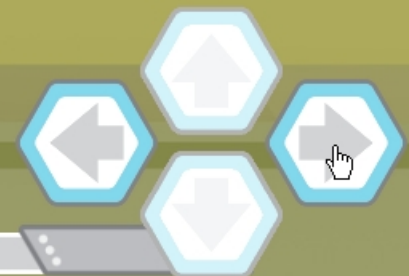





# Trolleybus

**ROBORISE-IT!**  
ROBOTIC EDUCATION

This is an electric bus that draws power from overhead wires. The disadvantages is: aesthetic (wires is unsightly in city), dewirements (sometimes it come off of the wire), difficulties when re-routing.



0



12





# Tram

This is a rail vehicle which runs on tramway tracks along public urban streets. Usually tramways powered by electricity. They produce a high sound pollution, but very effective. Also often the trams must to stop at the Traffic lights as usual cars.





# Metro

Also known as heavy rail, subway, MRT, tube, U-Bahn or underground, is a type of high-capacity public transport. It is very expensive due to the costs for building of the tunnels, but allows to create very effective transport system.





# Monorail

**ROBORISE-IT!**  
ROBOTIC EDUCATION

This is a railway in which the track consists of a single rail. In most cases rail is elevated, but monorails can also run at ground, below ground or in subway tunnels.





# Monorail

Unlike some trams and light rail systems, modern monorails are always separated from other traffic and pedestrians. It allows to make the very fast and safely transport system.





# Monorail

Often monorails is only one available transport that may be added to the existing city infrastructure. Other transport has a lower capacity (as trams) or is very expensive (as metro) or is influenced by other traffic (as trolleybuses).





# Let's summaries

We must to create the public transport system that:

- Has a great capacity.
- Has zero emission of air pollution.
- May be integrated into the existing city infrastructure.
- Not very expensive.





# Discussion of the task



rka@gmail.com

What do you think, which type of the electric public transport is better for our needs?

0

19

A set of navigation icons including a yellow starburst, a play button, and a number 19, all contained within hexagonal frames.

A set of navigation icons including four arrows (up, down, left, right) and a central play button, all contained within hexagonal frames.





# Meet MonoRail!

ROBORISE-IT!  
ROBOTIC EDUCATION

This is a robotised  
autonomous monorail.



**MonoRail**

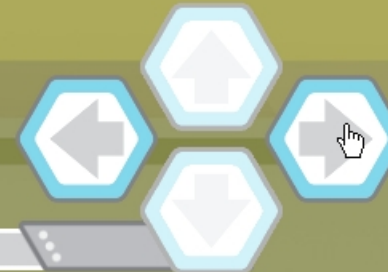



# Monorail's elements

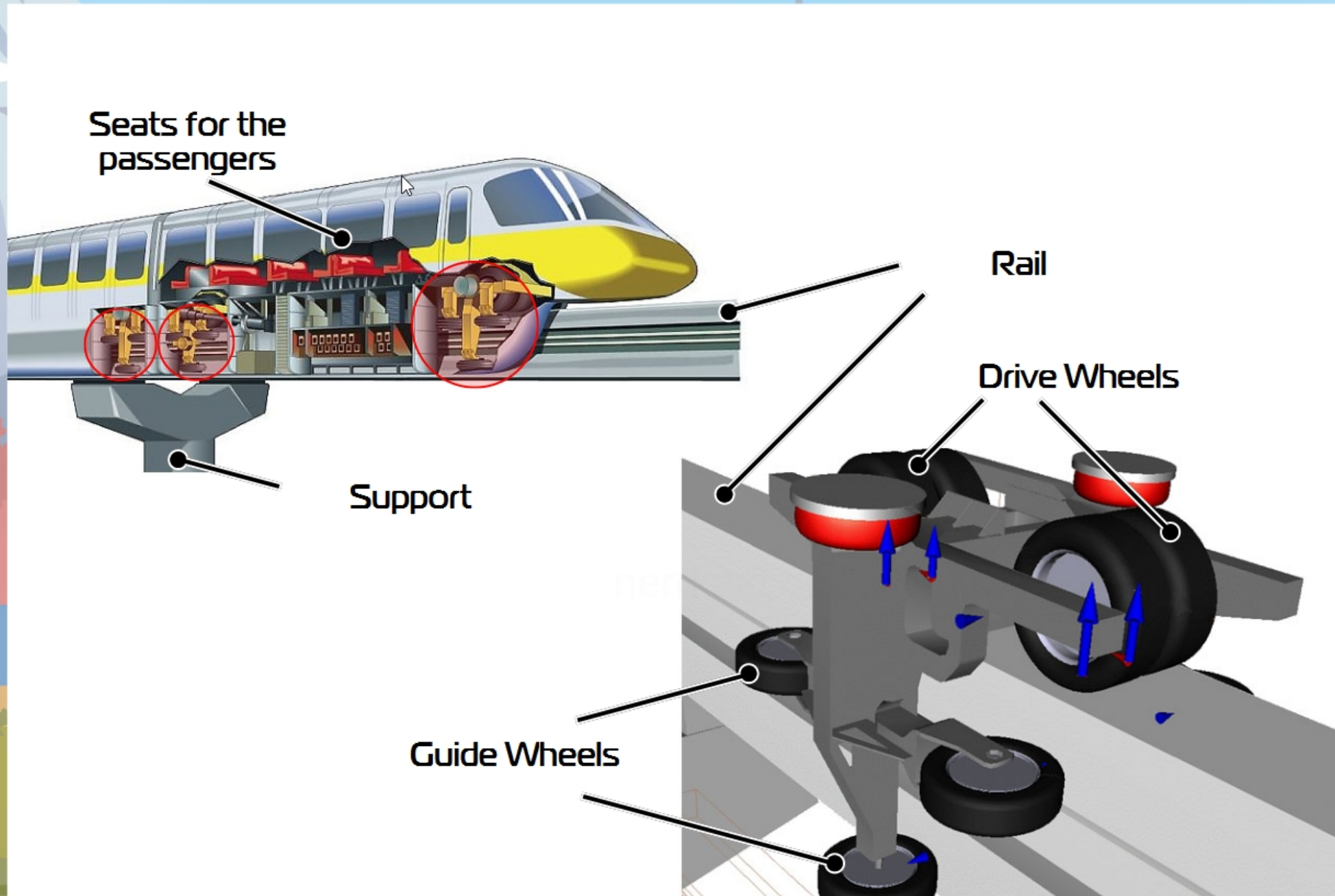



# Monorail's elements

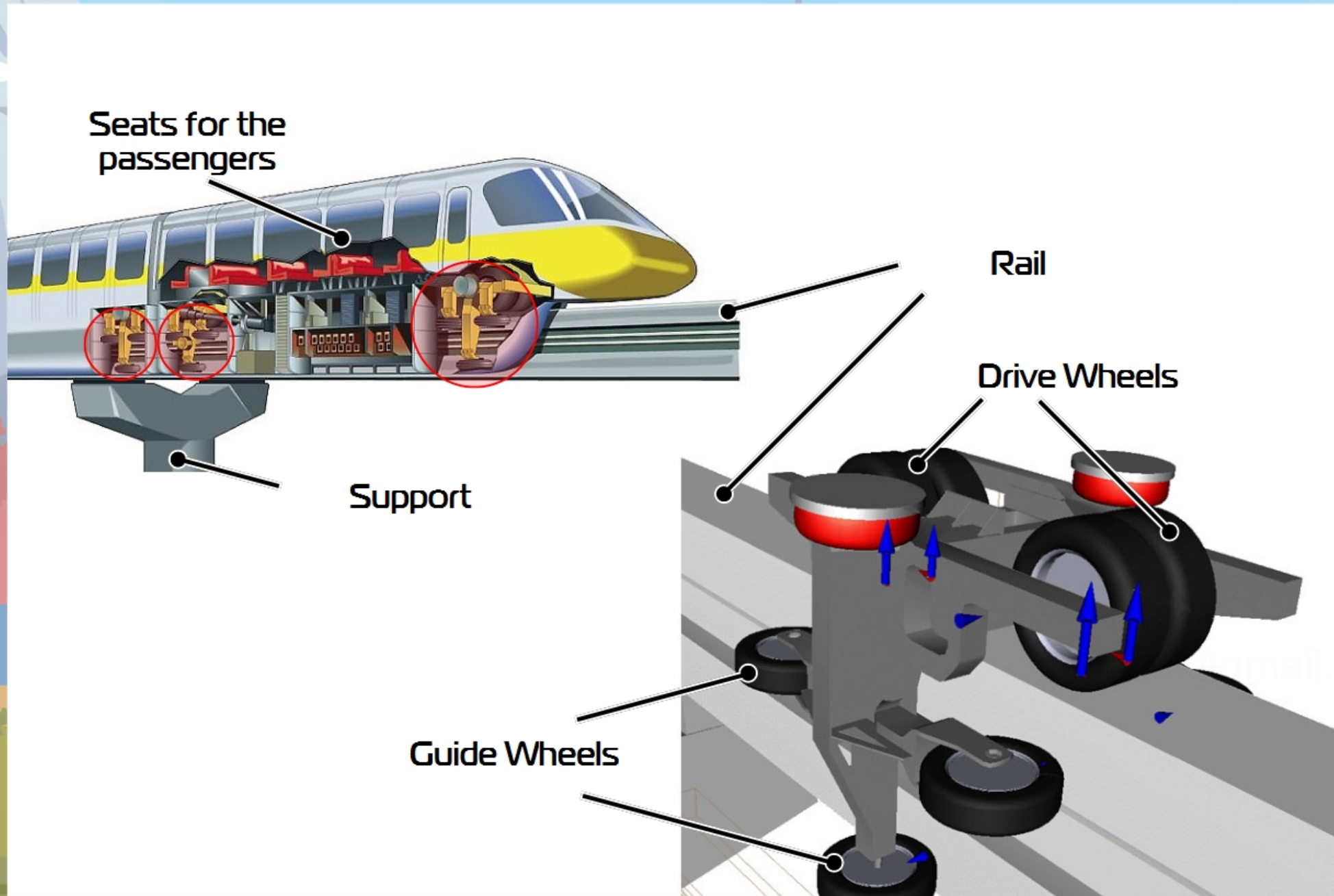

0



21





# Features

The motor is used for movement of the MonoRail. The motion sensor can be used to station detection.

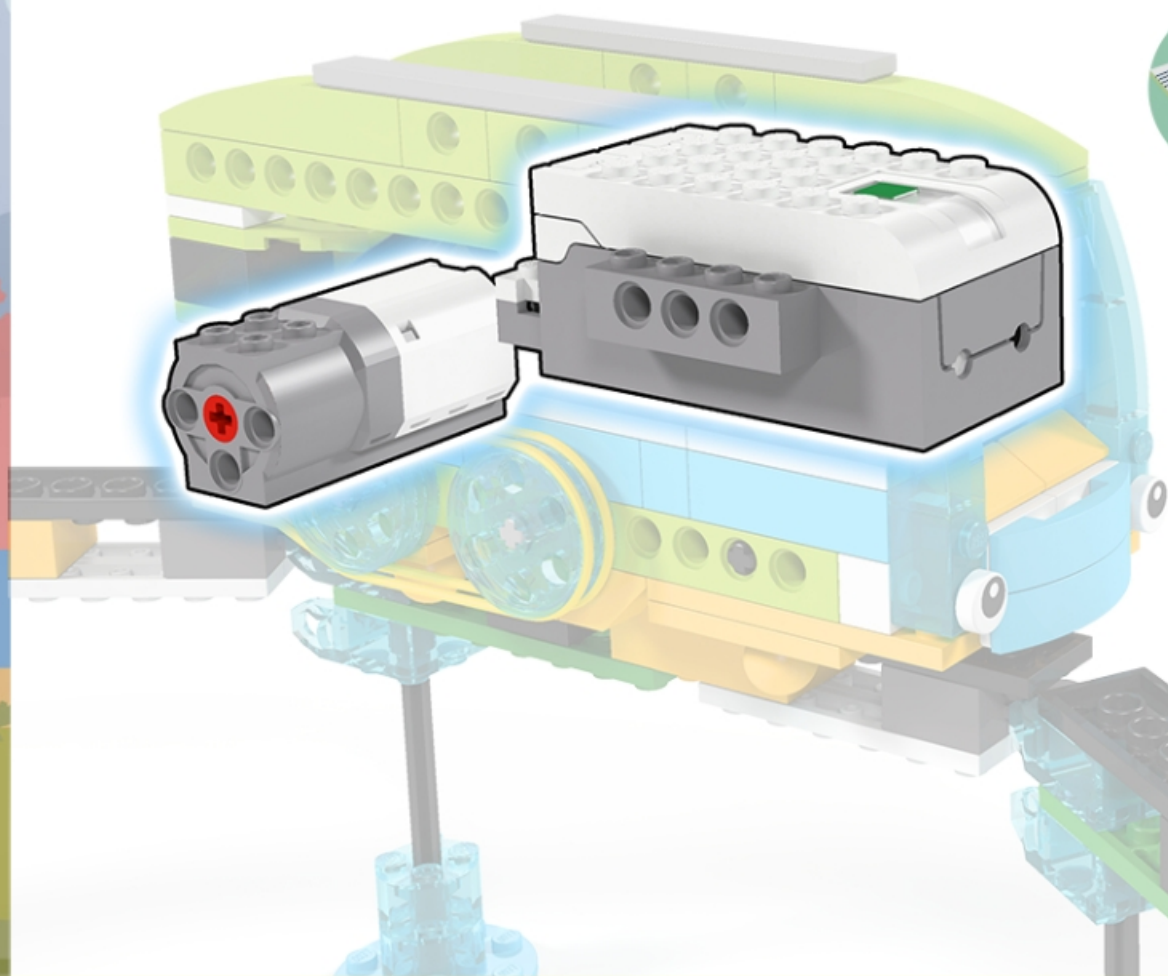

Find:

- ▶ smarthub
- ▶ motor
- ▶ sensor



0



22





# Features

nerrka@gmail.com

**ROBORISE-IT!**  
ROBOTIC EDUCATION

The separate parts of the rails can be connected together to achieve a Circular route.

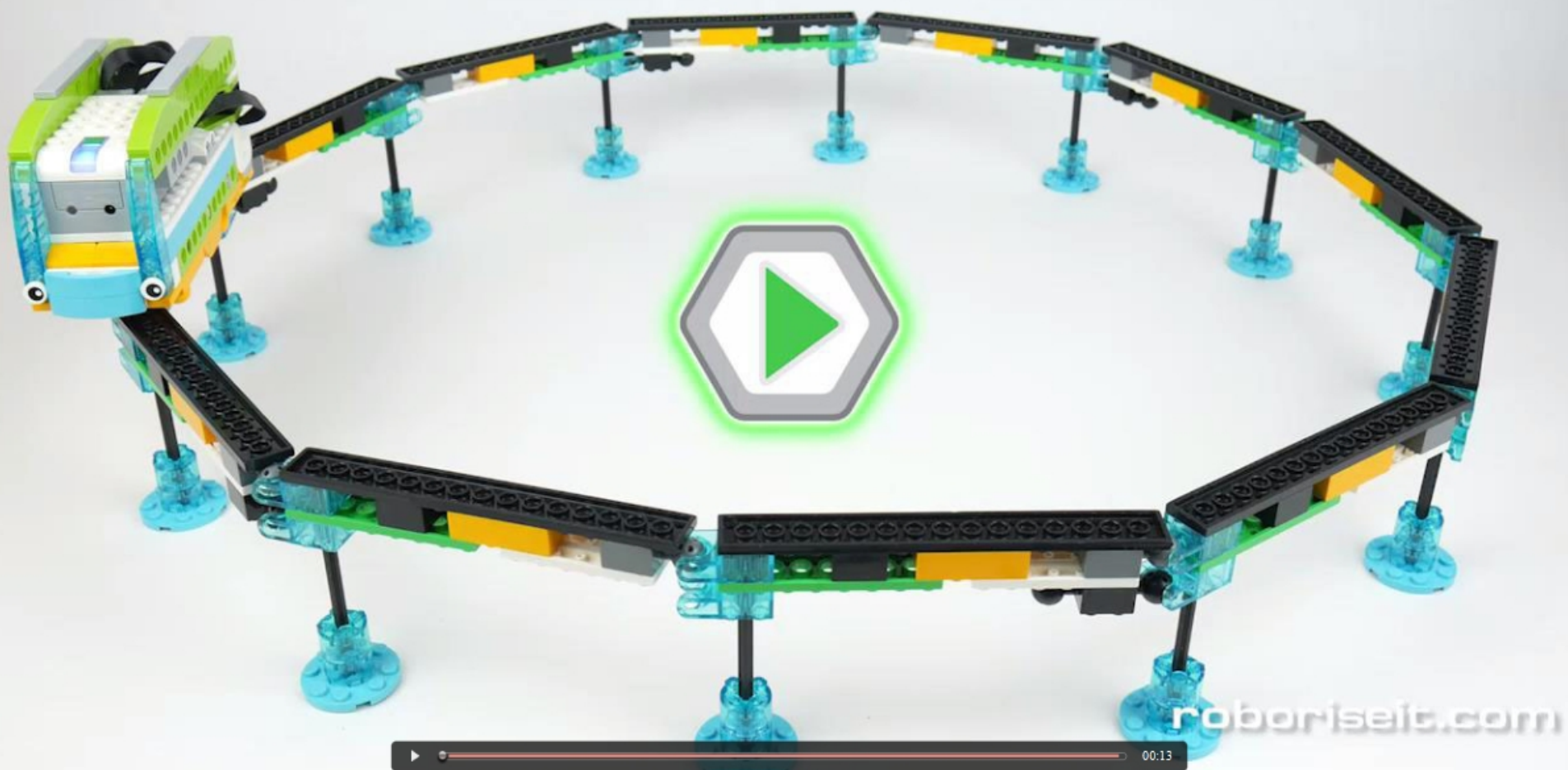



# Features

The rotation is transmitted from the motor to the Drive wheels due to the Belt drive. Compare the size of the contact of the belt with first and second pulley. How do you think, what will this lead to?

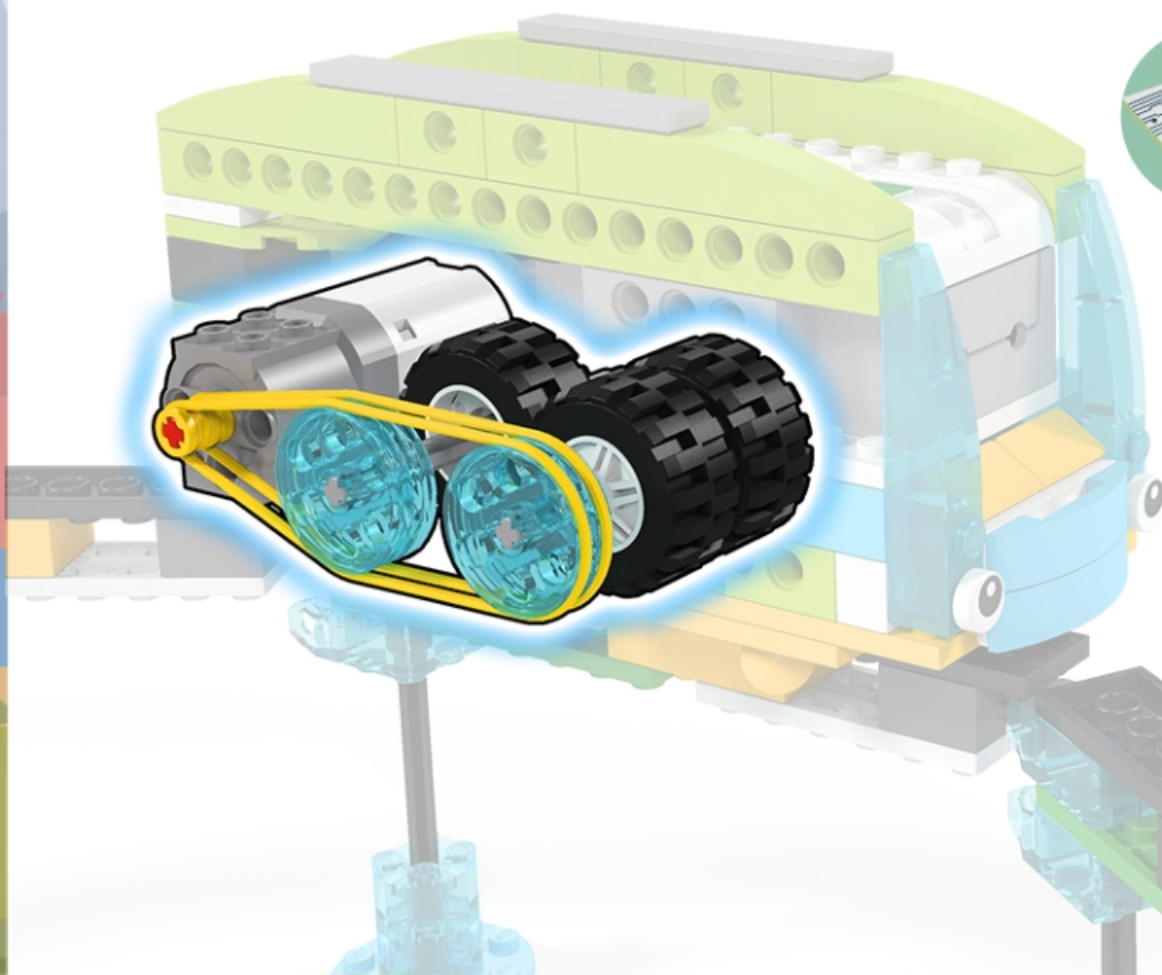

Find:

- Motor
- Belt drive
- Drive Wheels





# Features

ROBORISE-IT!  
ROBOTIC EDUCATION

How do you think, why robot needs two Drive axles?



roboriseit.com





# Features

MonoRail has the guides for run through the curves of the rail.  
They fix the robot on the rail.

Guides

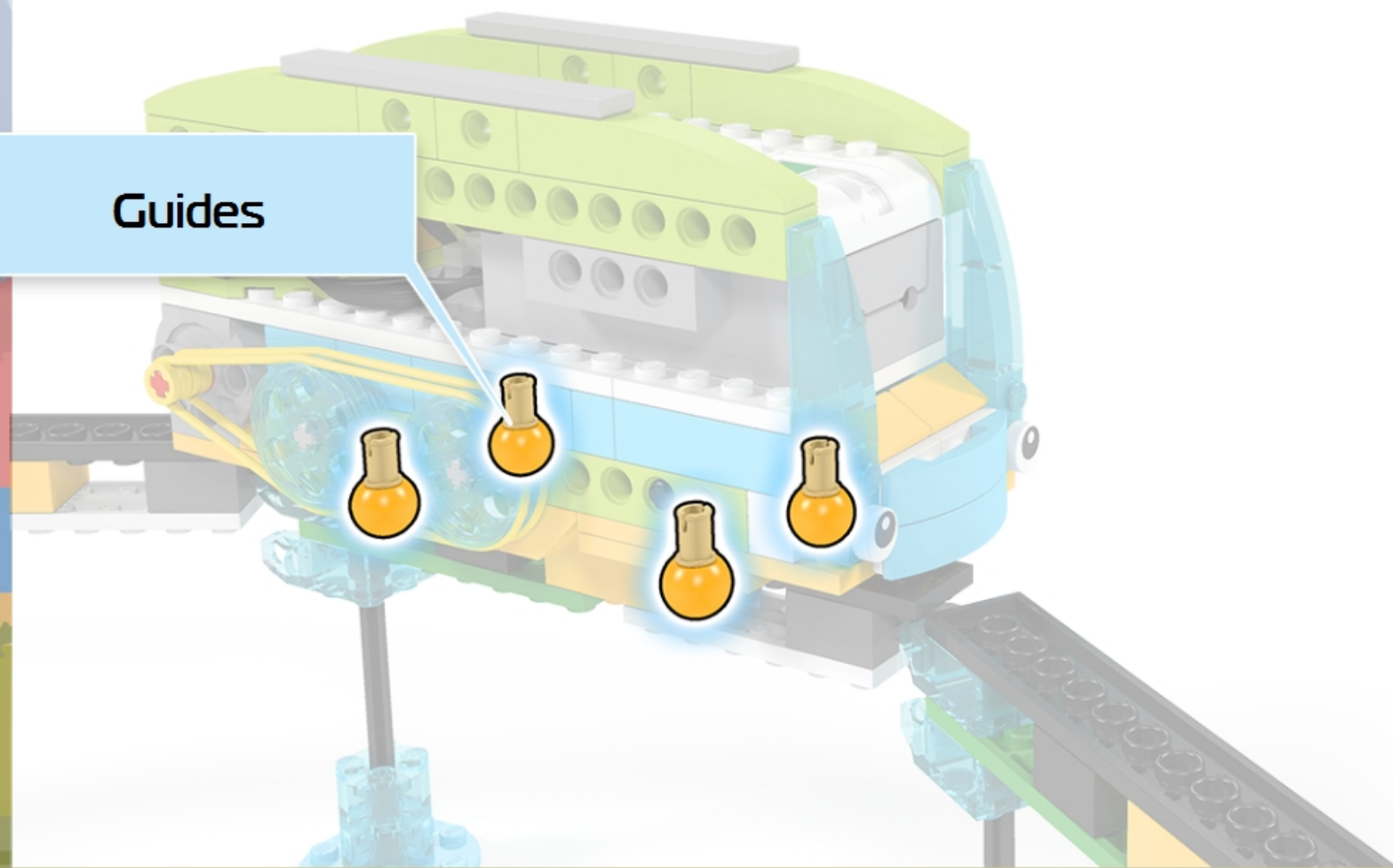





# Features

**ROBORISE-IT!**  
ROBOTIC EDUCATION

Note, that Guides not touches the rail on the straight sections. But they works on the curves.

nerrka@gmail.com

Guides

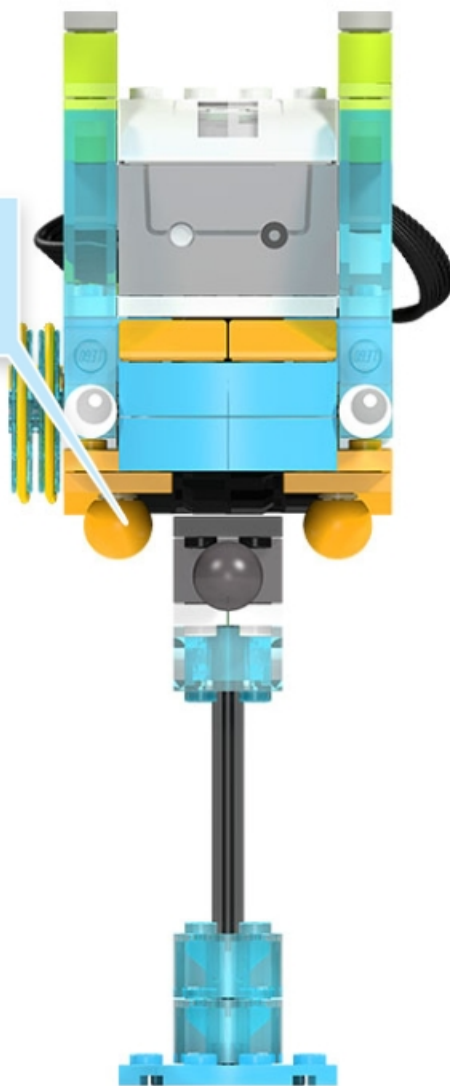

0



27





# Build the robot!

**ROBORISE-IT!**  
ROBOTIC EDUCATION



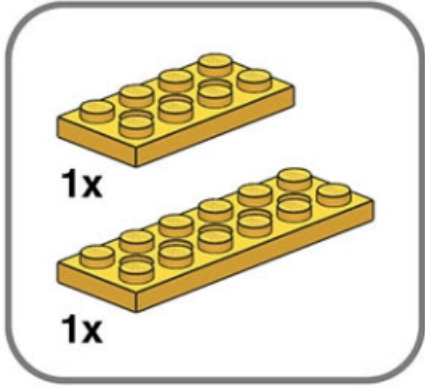

**1**

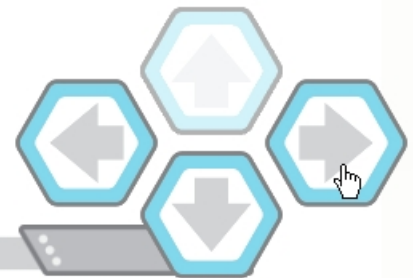
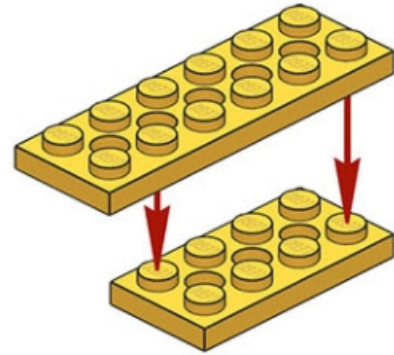



# Enhanced version

**ROBORISE-IT!**  
ROBOTIC EDUCATION

Build more comfortable  
train saloon.

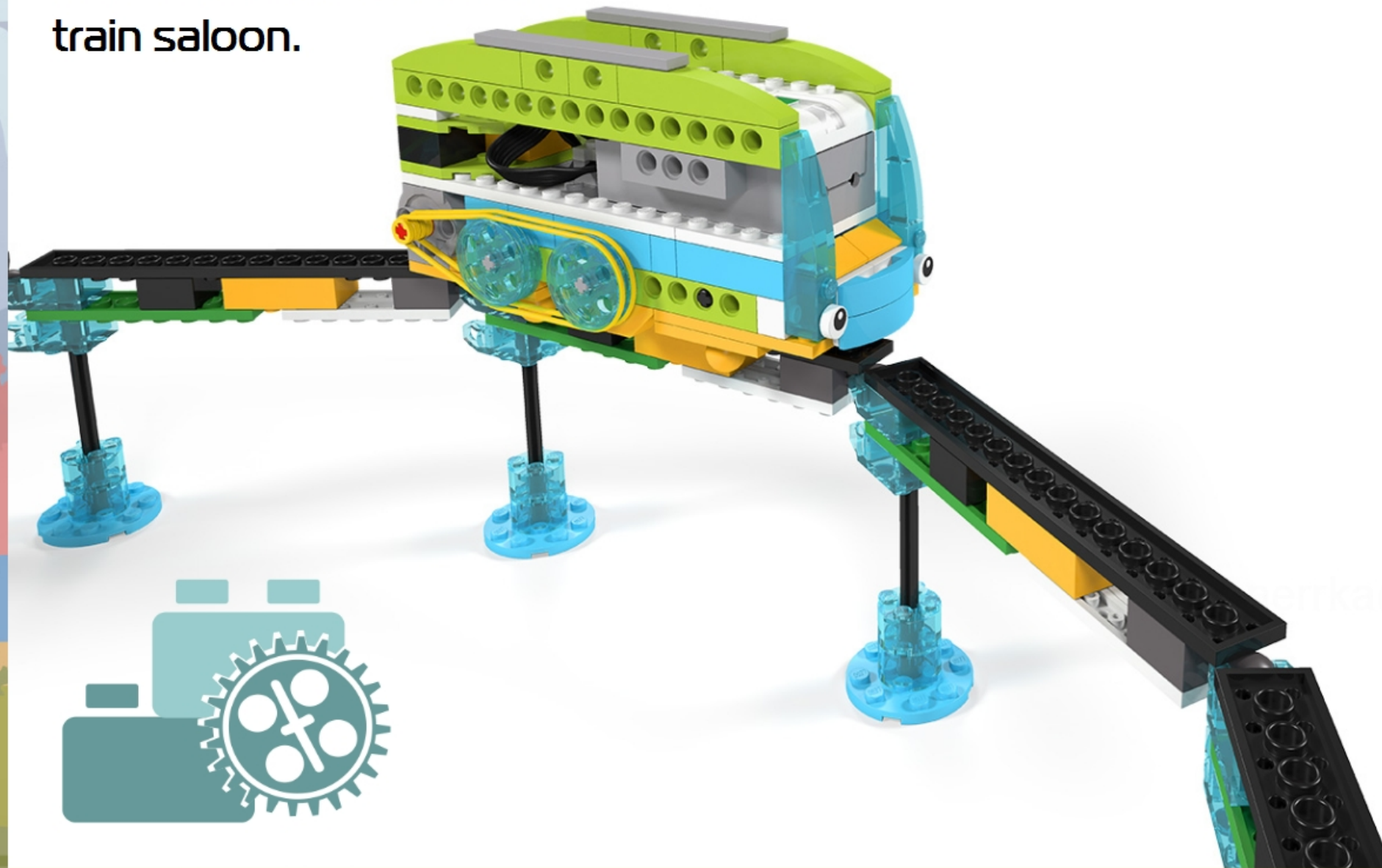

85



nerrka@gmail.com

**ROBORISE-IT!**  
ROBOTIC EDUCATION

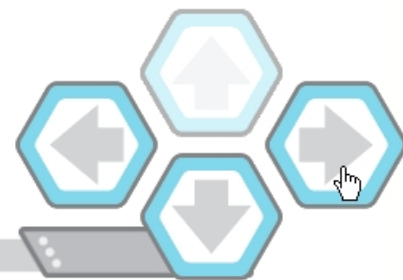
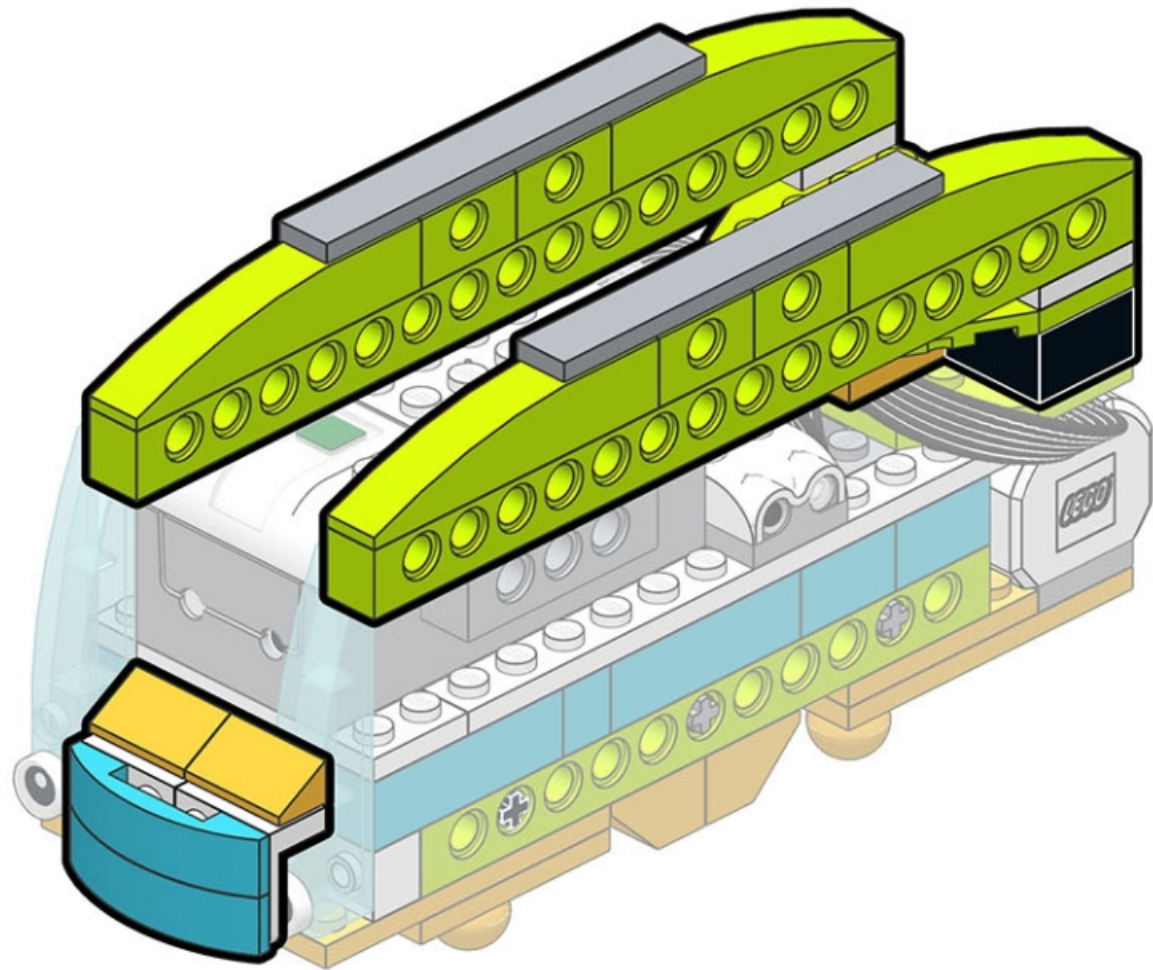



# Check it out!

Avoid any friction  
between the cables  
while robot is moving.

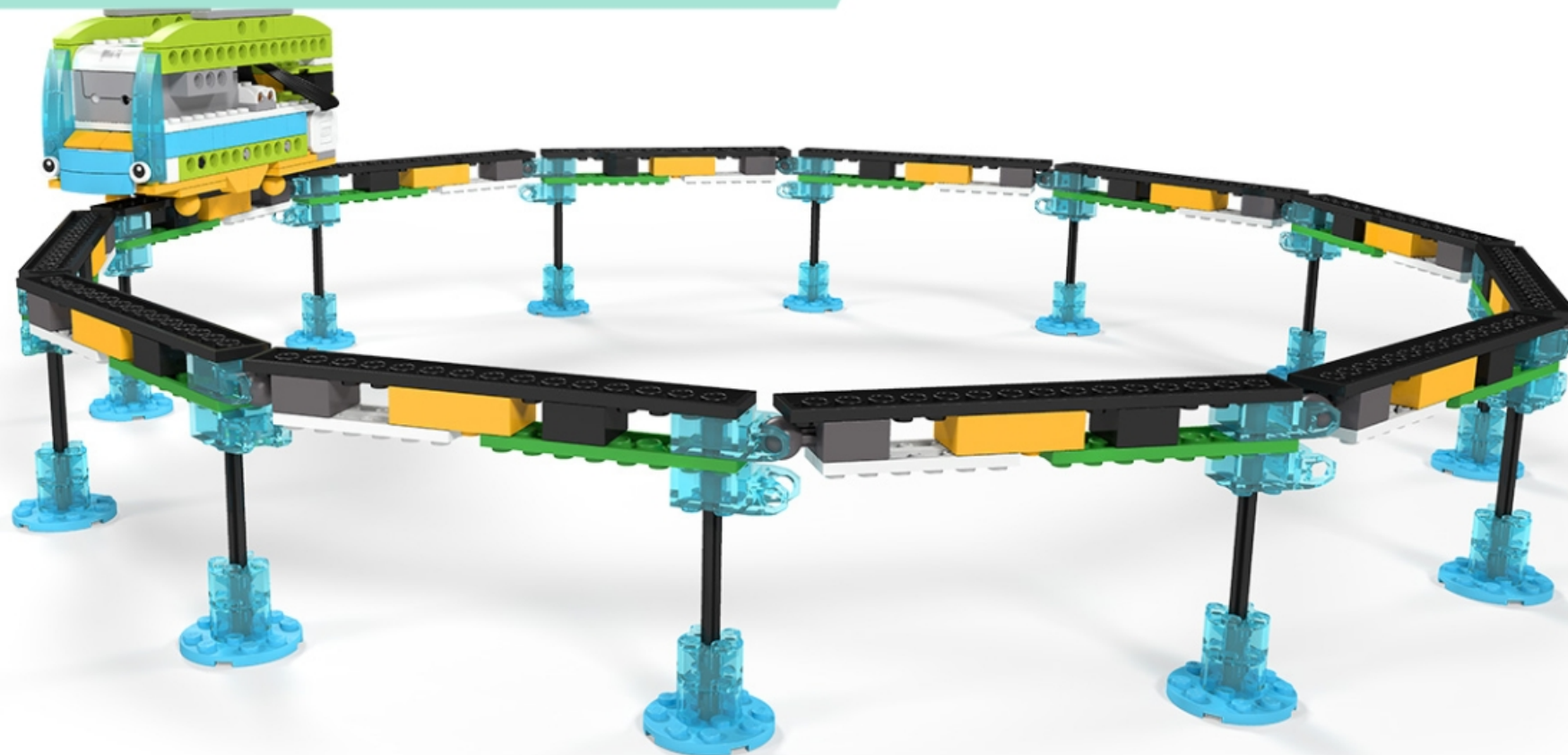

0



98





# TASK

Place parts of the robot in the right places.

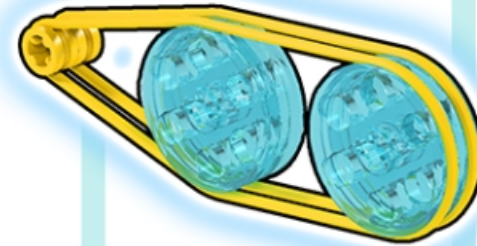
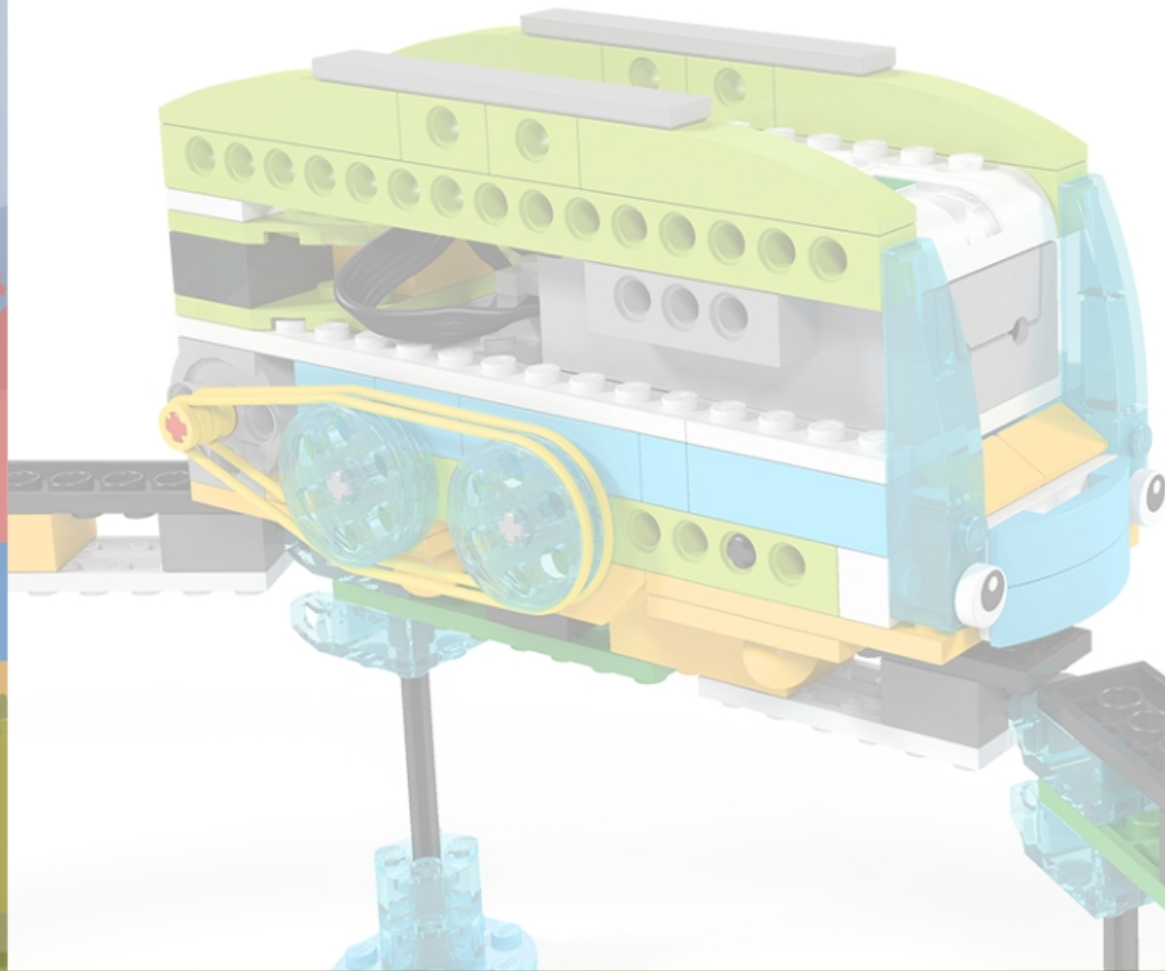

0



99





# Task 1

Check the mechanism. The MonoRail must smoothly run via each joint of the road.







## Task 2

Program the stop of the monorail near the station. Note, that robot must to stop at the center of the station.



roboriseit.com

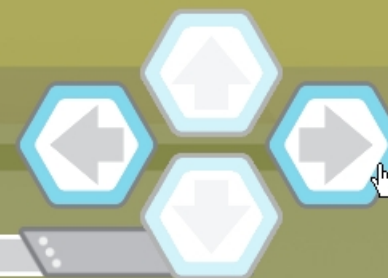
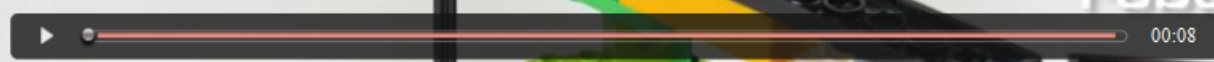



## Task 2. Algorithm

The program should run by the following algorithm:

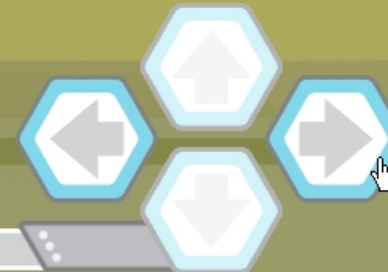
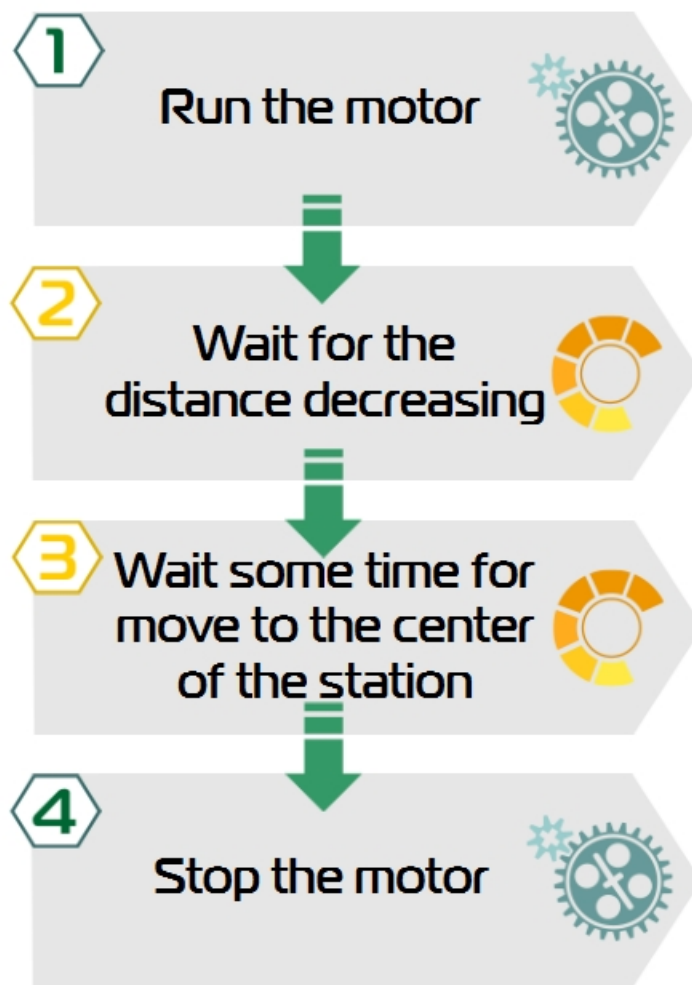



# Task 3. Program

1

Run the motor



Step:



# Task 3. Program

1 Run the 2 Wait for the distance decreasing

A sequence of Scratch code blocks: a yellow Play block, a green Rotate block, a green Motor block, a yellow Wait block, and an orange Distance sensor block. The Distance sensor block has a value of 8.

Step: 1 — 2 — 3 — 4

Scratch interface icons: a yellow star icon with the number 0, and a green play button icon with the number 103.

Scratch navigation icons: four light blue hexagonal buttons with arrows pointing up, down, left, and right.

# Task 3. Program

- 1 Run the
- 2 Wait for distance d
- 3 Wait some time for move to the center of the station

A sequence of programming blocks: a yellow 'Run' block, a green 'Repeat' block with a robot icon, a green 'Move' block with a robot icon, a yellow 'Wait' block with a sand timer icon and a value of 8, and another yellow 'Wait' block with a sand timer icon and a question mark.

Adjust the duration of the waiting



0  
103

# Task 3. Program

- 1 Run the
- 2 Wait for distance d
- 3 Wait some move to th of the s
- 4 Stop the motor

8 ?

Adjust the duration of the waiting

Step:





# Task 3

Program the continuous transfers between the stations.

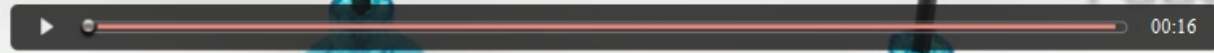



# Task 3. Algorithm

The program should run by the following algorithm:

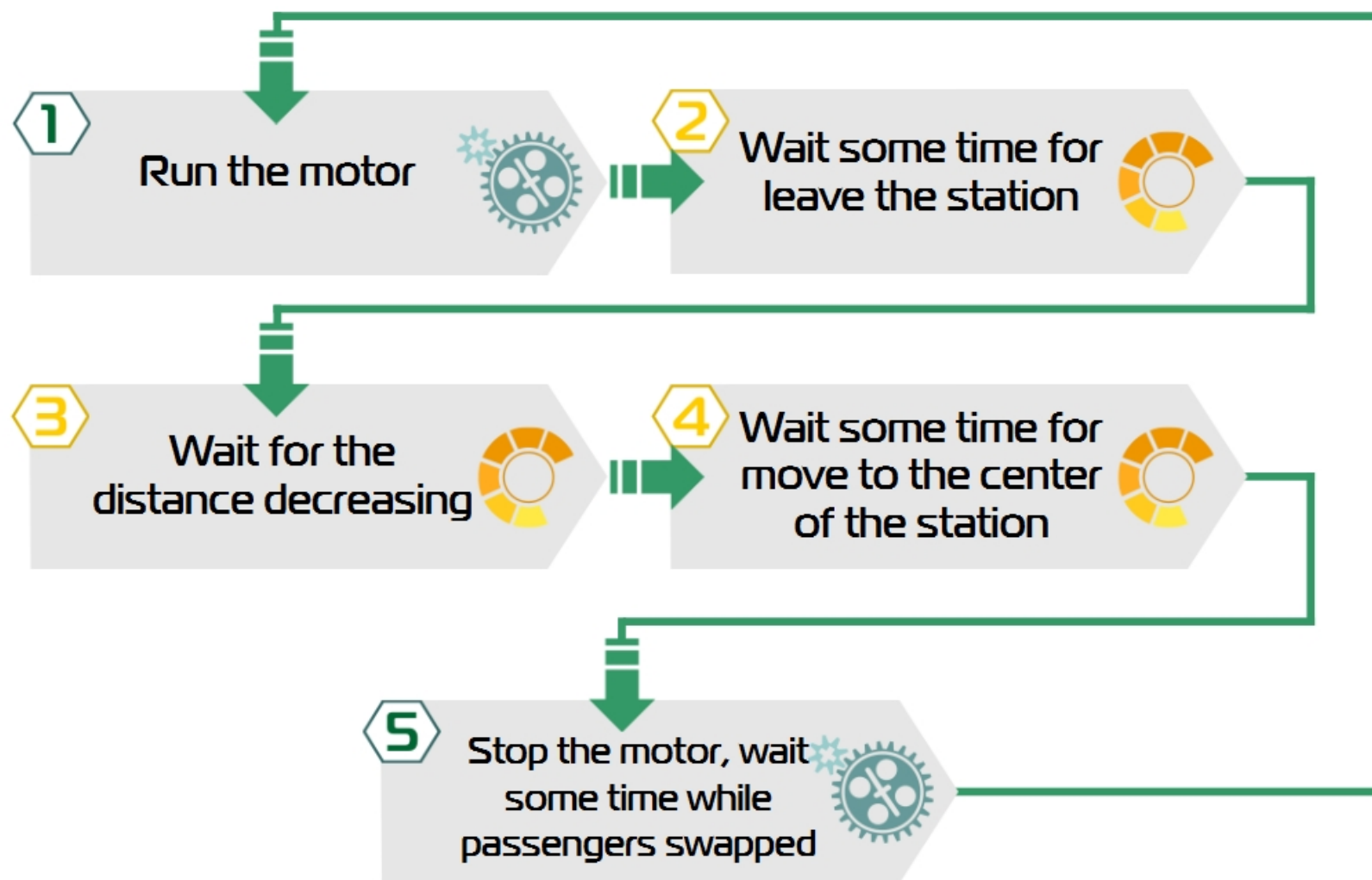

0



105







# Task 4

Build and place near the rail few stations and display on the screen the number of the stops on the stations.

0



roboriseit.com

00:38



0



106





## Task 4. Program

For modify your program you need only a few blocks. First of all at the program begin you must to set the number of the passed stations to the "0". Then at the each loop iteration the value of the variable must be increased on the "1".

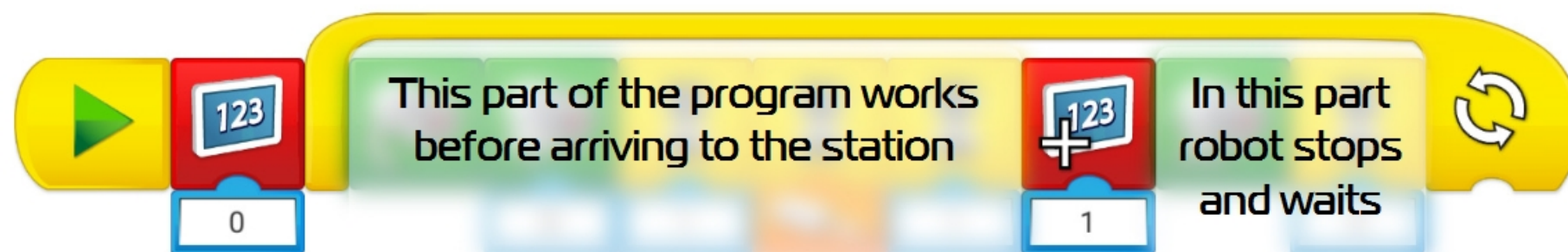

Note! Your program may be differ. The above screenshot is for reference only.





## Task 5\*

berka@gmail.com

ROBORISE-IT!  
ROBOTIC EDUCATION

Let's calculate how many full circles will finish the robot in a two minutes. To do this you may divide the number of passed station on the number of station on the route. The number of the full circles is the integer part of the result.

$$N = \frac{\text{\# passed station}}{\text{\# station on the route}}$$



0

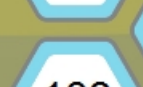

108





# Task 6

Re-built the rails to make the straight section and place two stations on the ends.



109





# Task 7

Program the work of the robot on such route. Note, that for stop at the center of the stations robot will need different Wait block settings.

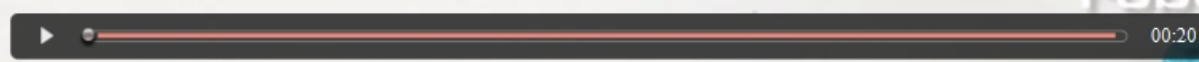



# TASK

Sort the transport by the cost of the construction. Drag and drop corresponding icons.





# Discuss!

- What advantages the monorail has?
- Why the electric public transport is better for using in a large cities?
- What types of public transport presented in our city?





# Your achievements

nerka@gmail.com  
Total count: 0 

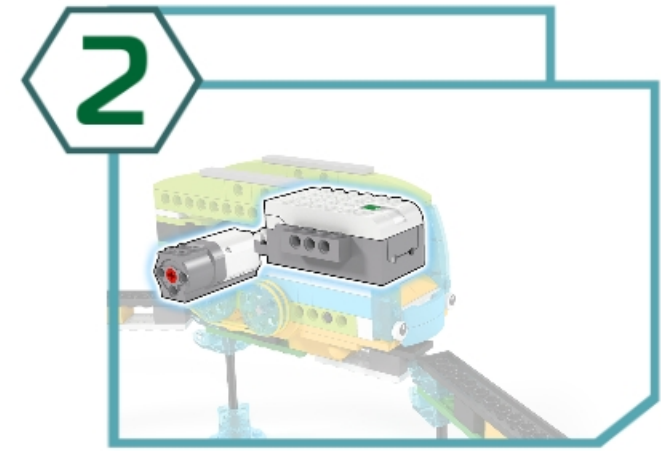

113





# Mission complete!

ROBORISE-IT!  
ROBOTIC EDUCATION



0

114