

# WeDo Kicker

Football Player Leg

Academia creativa de tecnología

# Tecnoaprendo

1

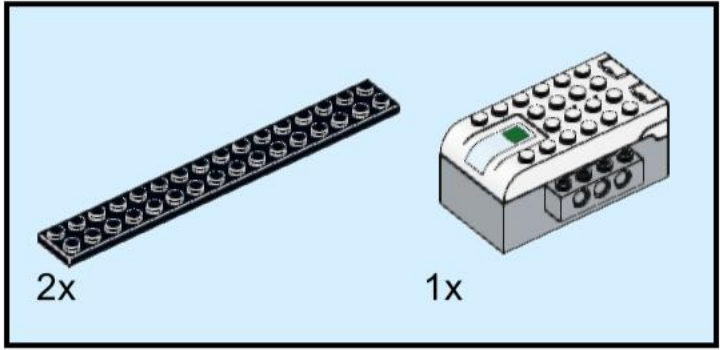

2

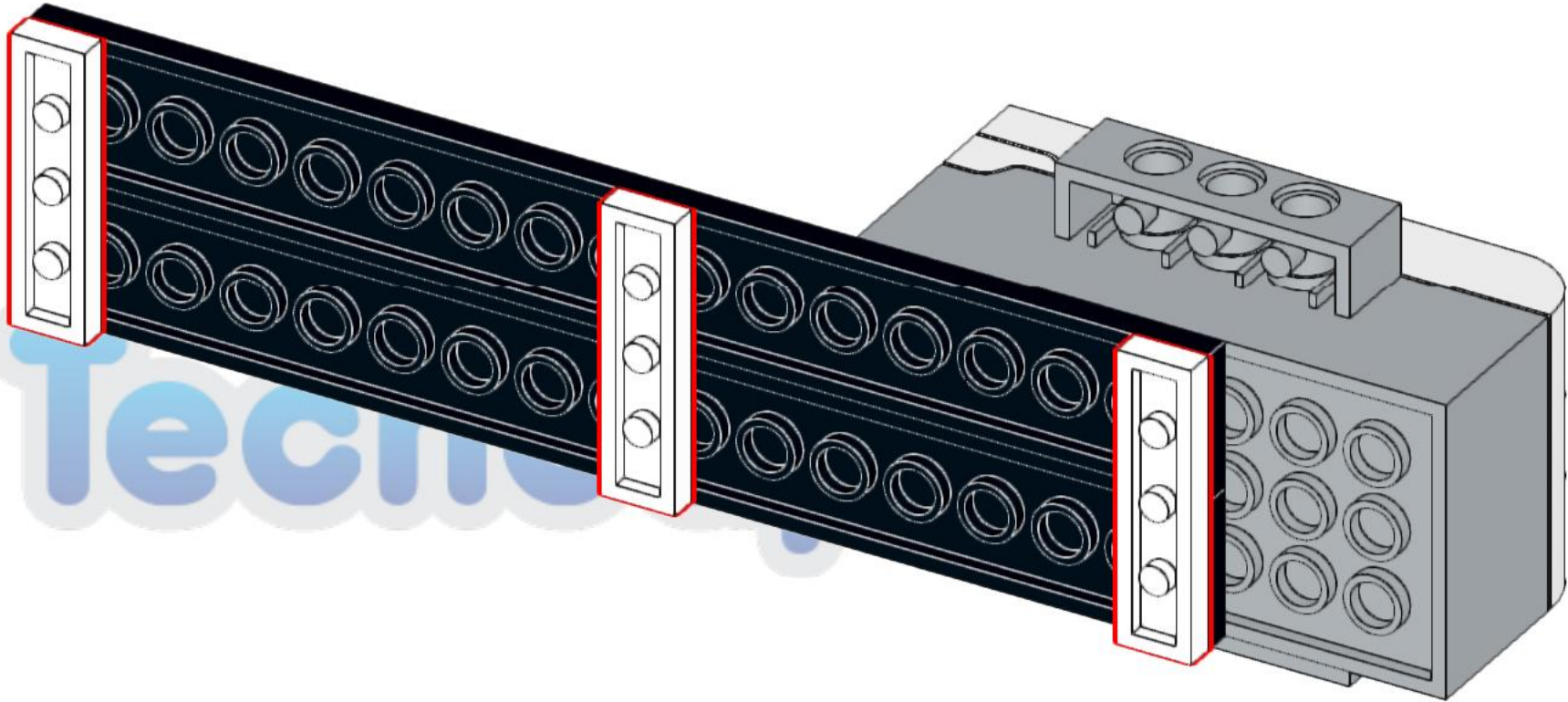
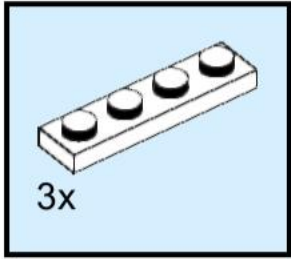

3

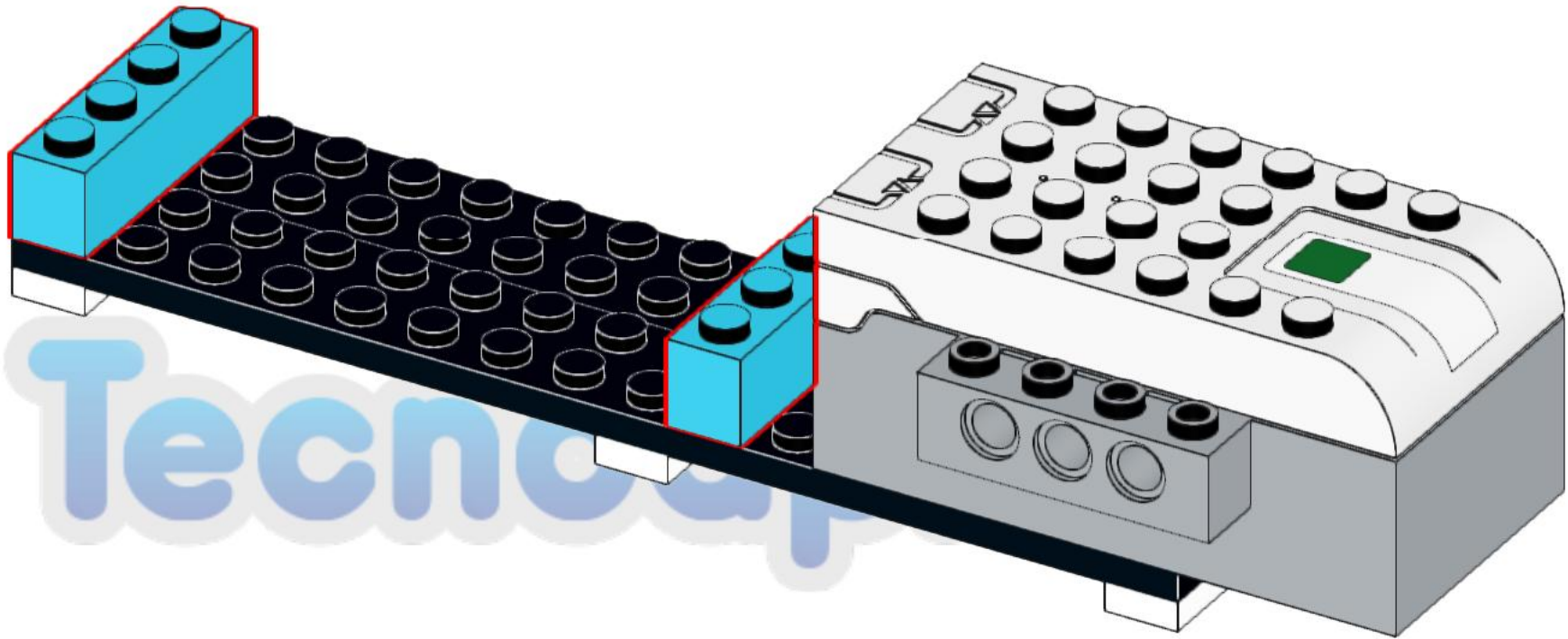
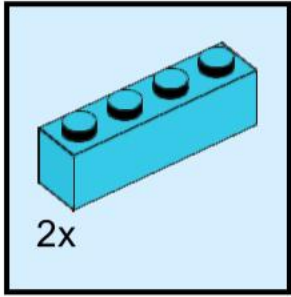

4

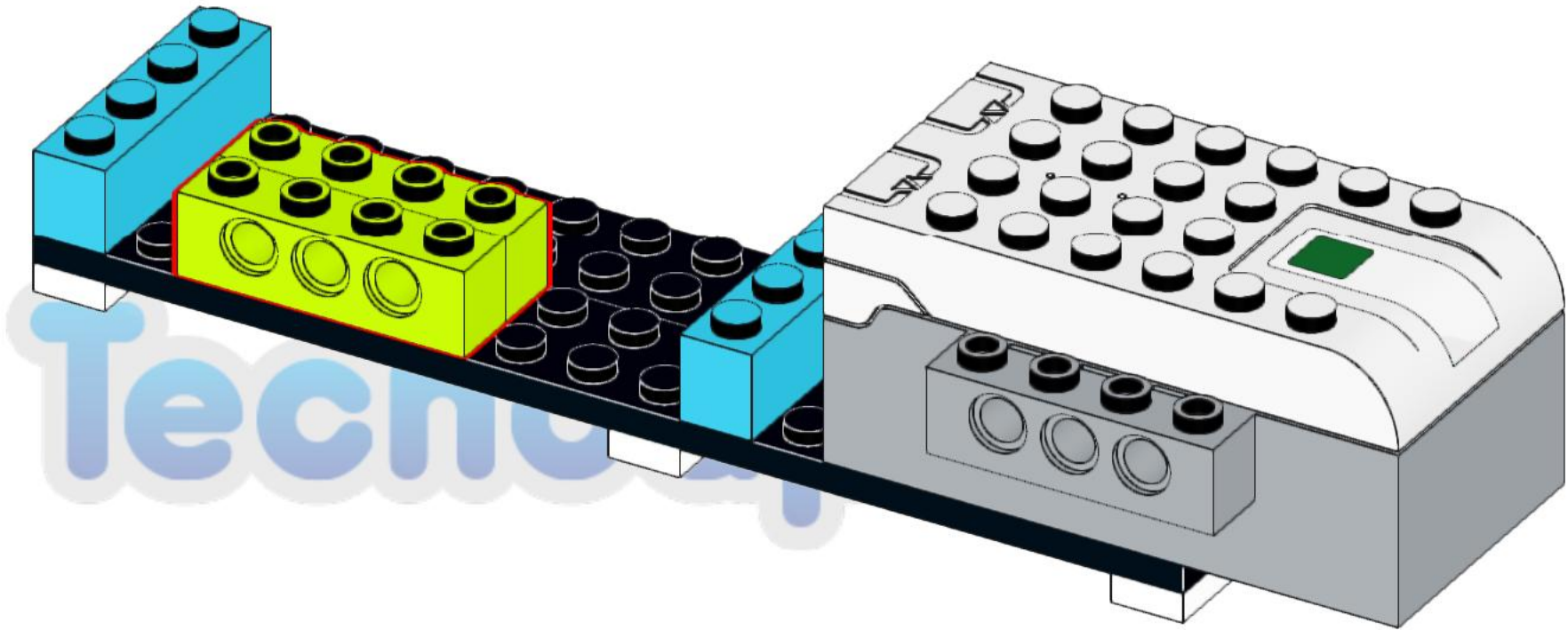
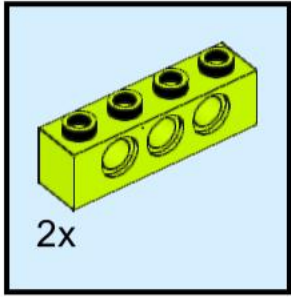

Technic

5

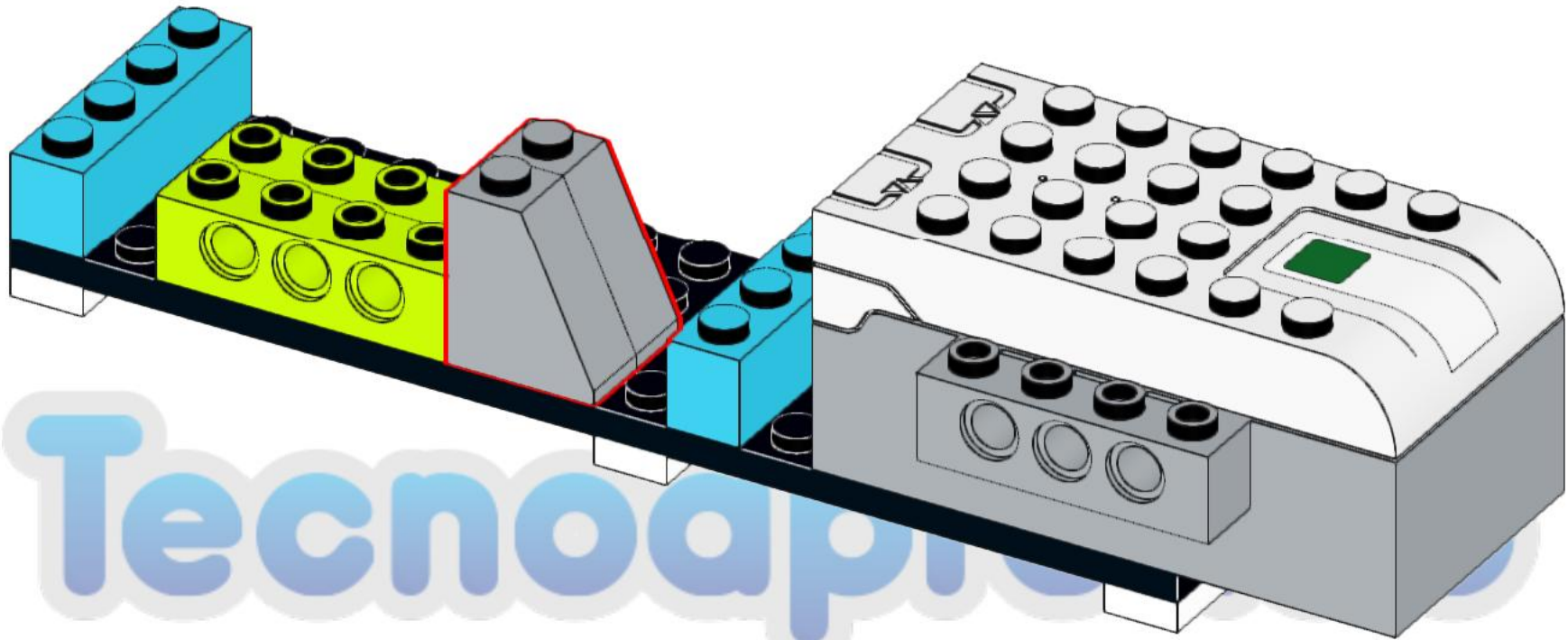
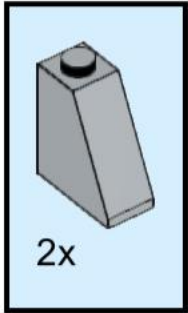

Tecnoaplic

6

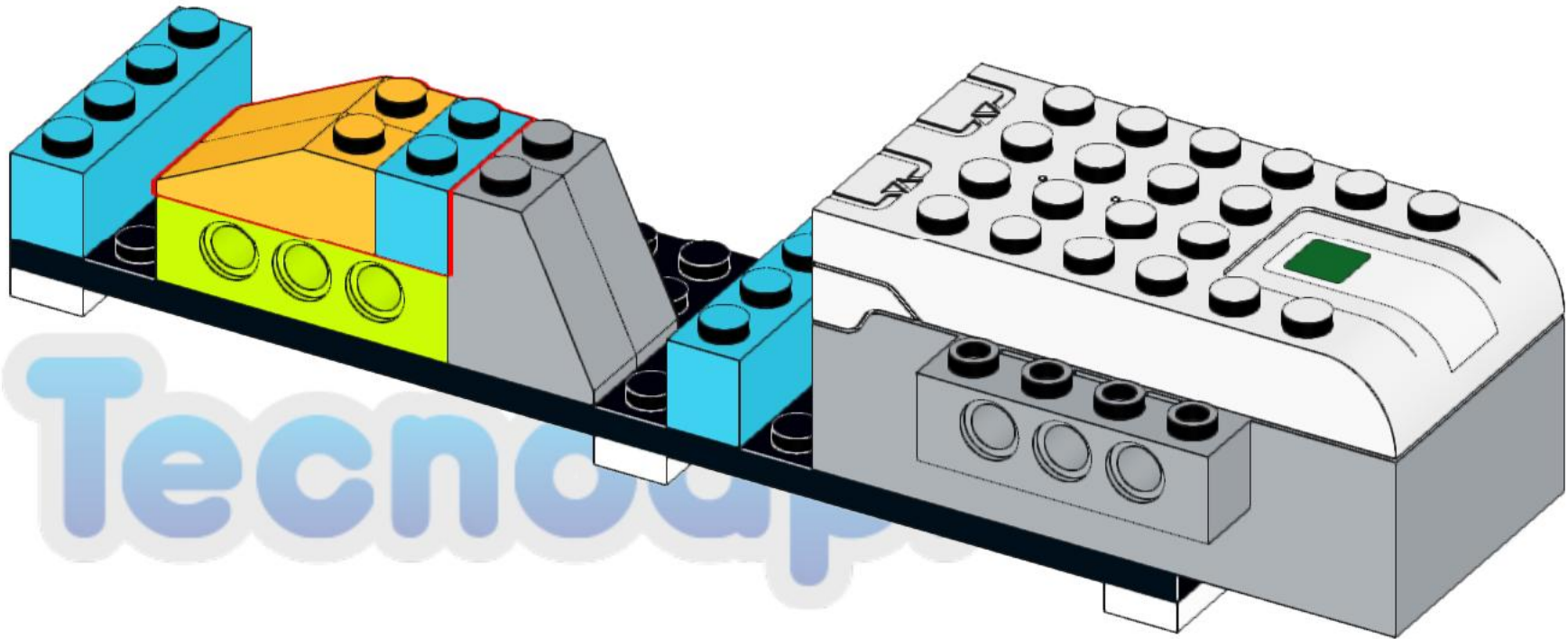
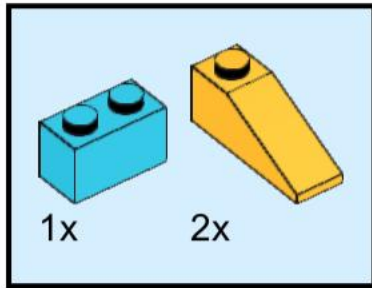

7

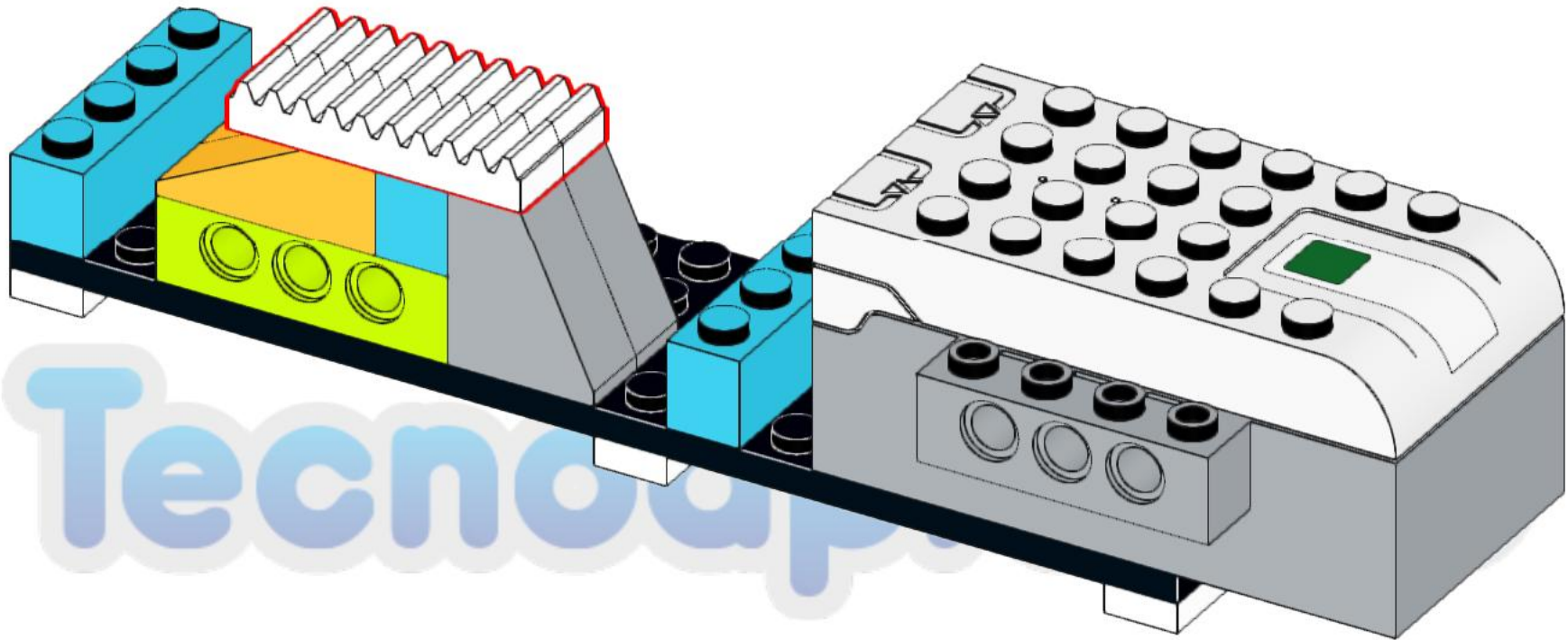
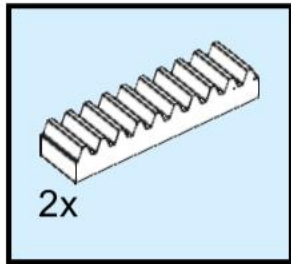

Tecnop...



8

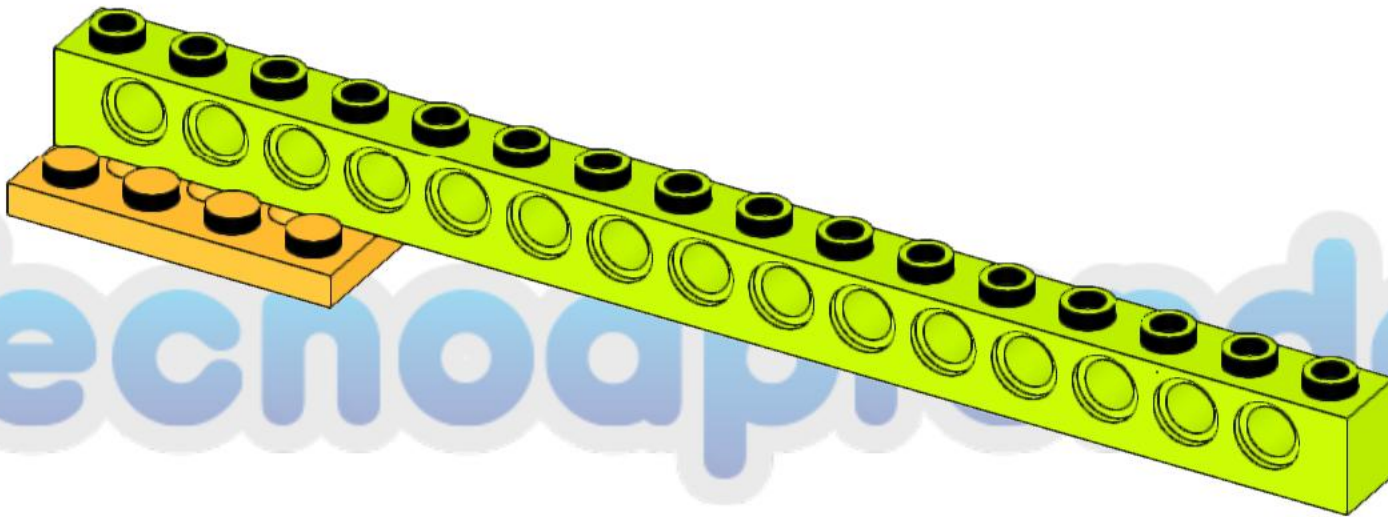
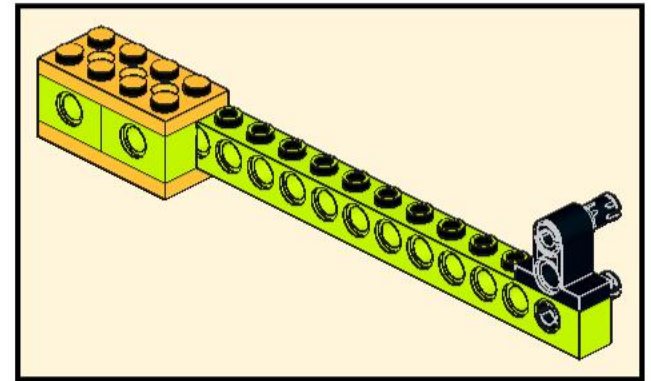
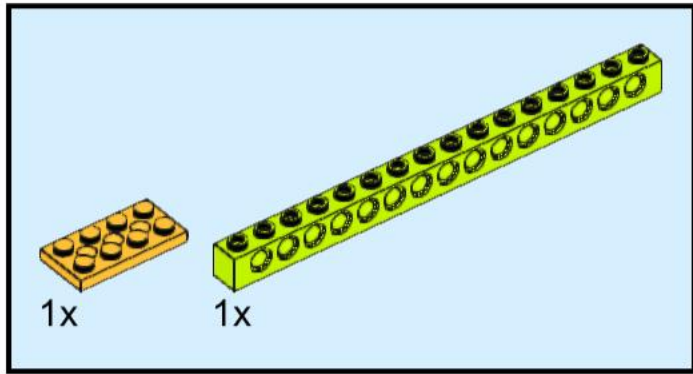

Technoaprendo

9

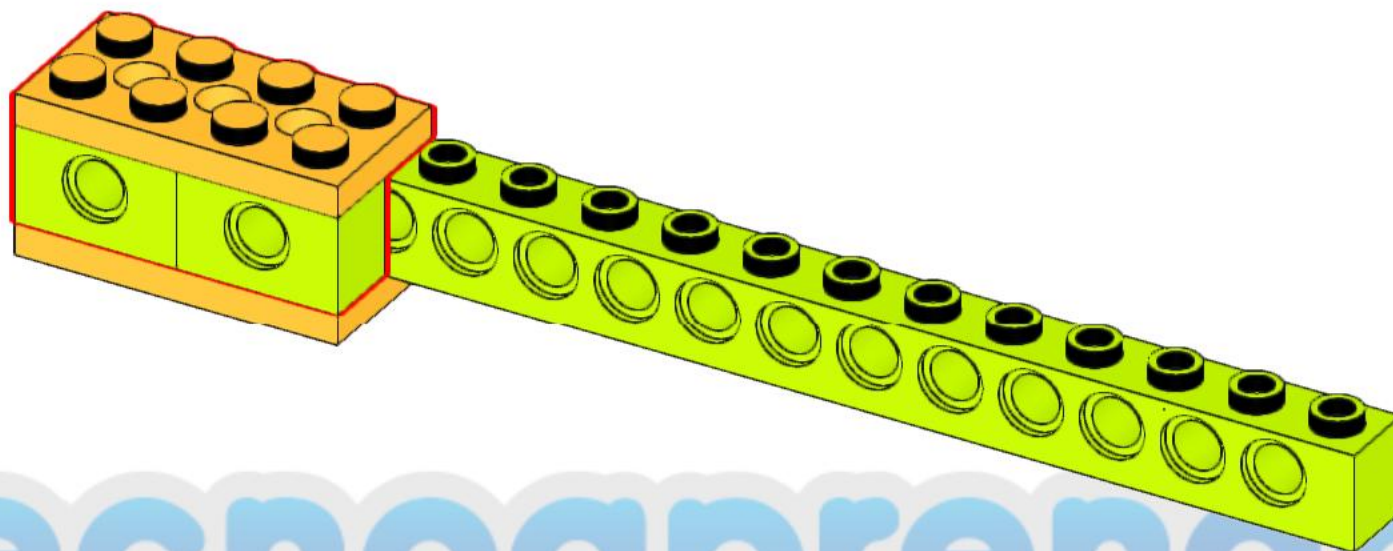
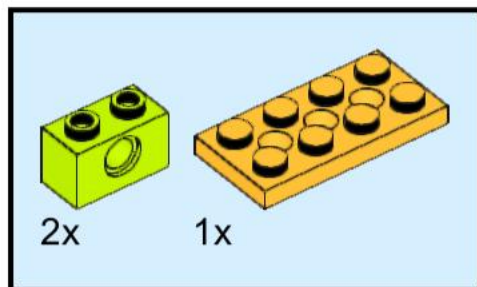

Tecnoaprenda

10

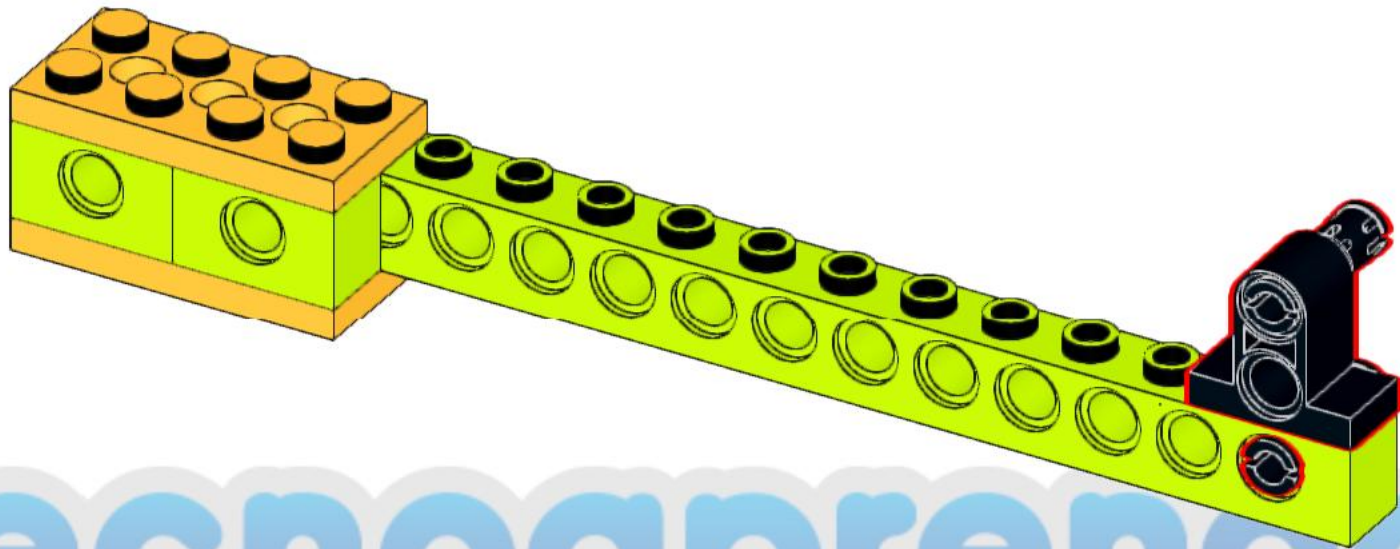
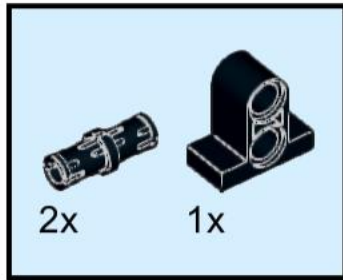

Tecnoaprendo

11

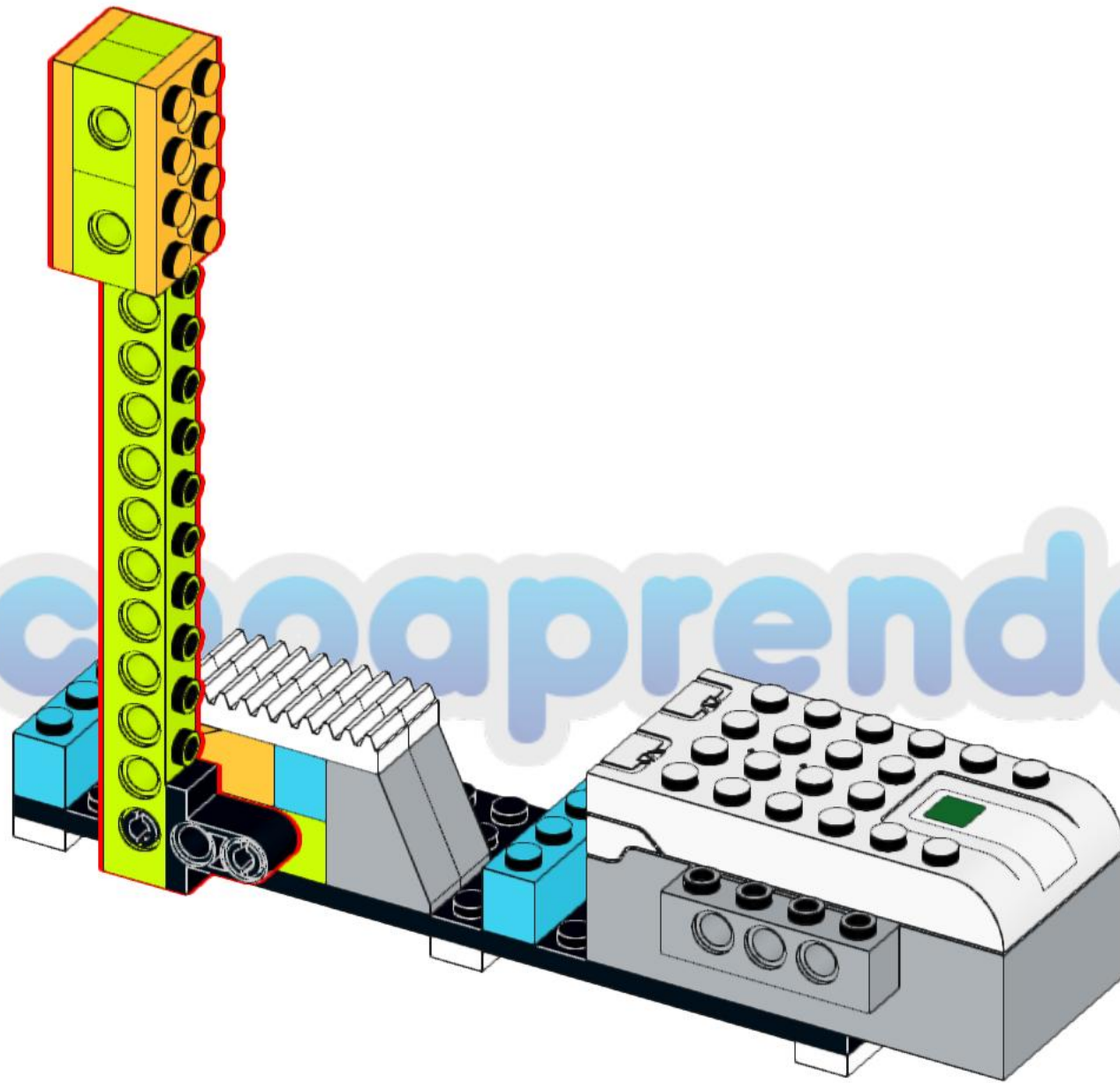

12

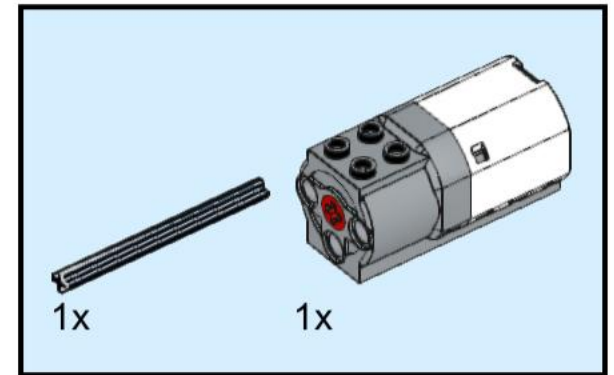
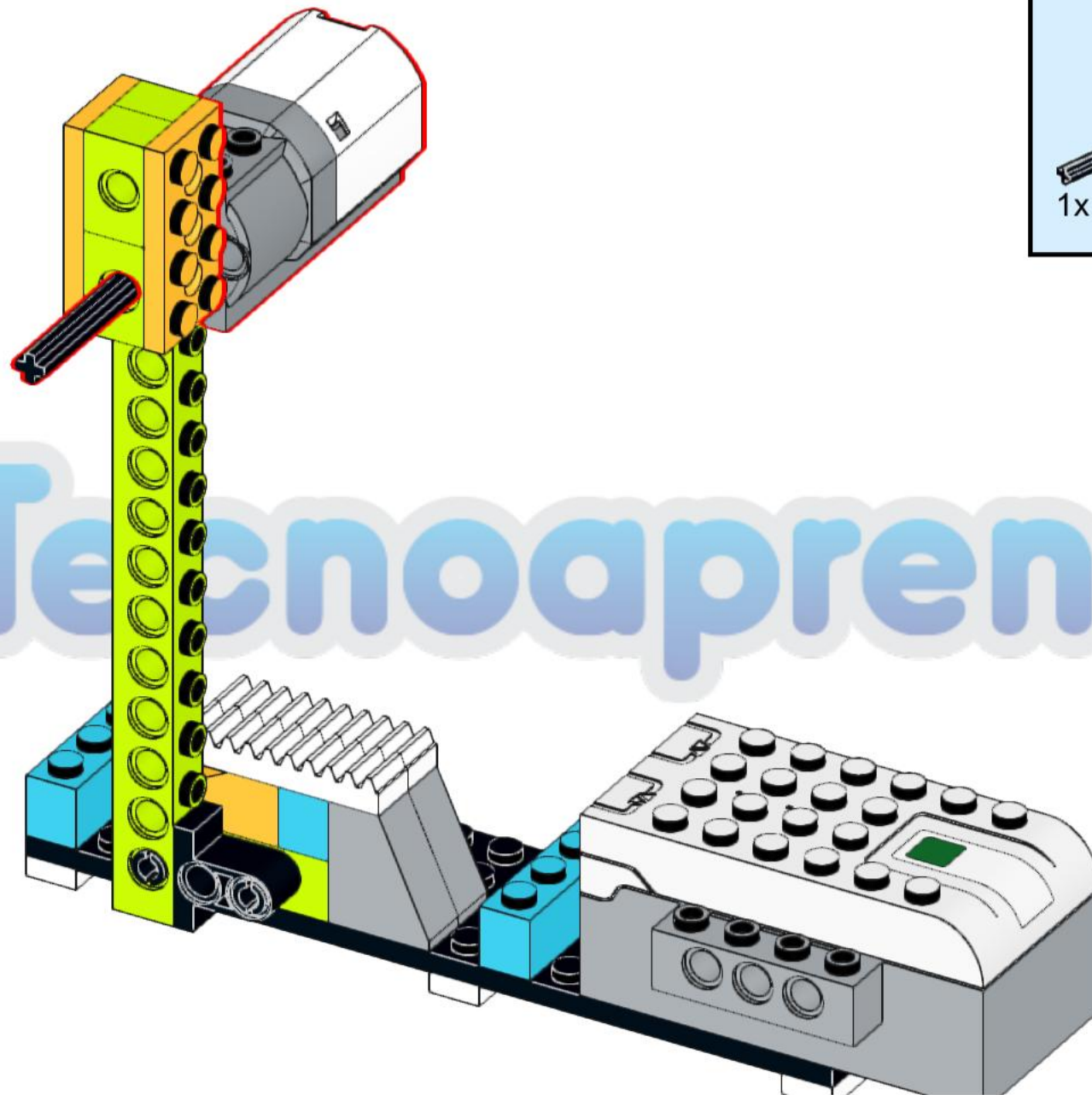

Tecnoaprendo

# 13

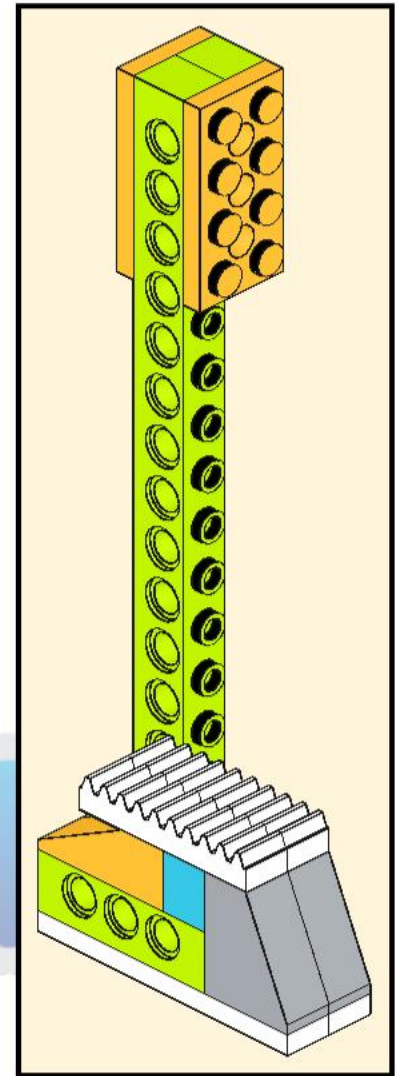
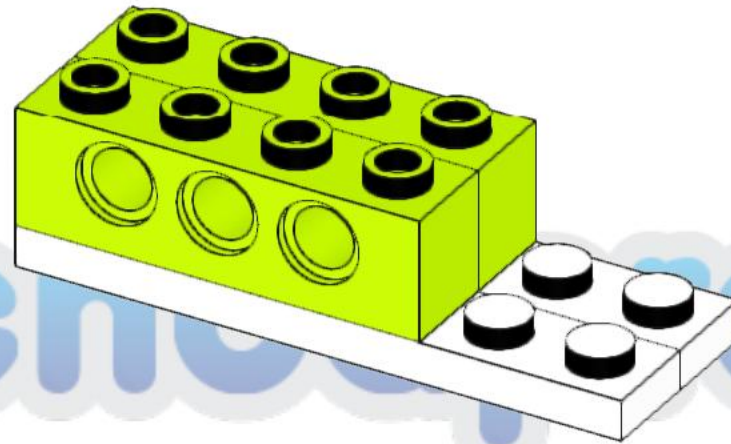
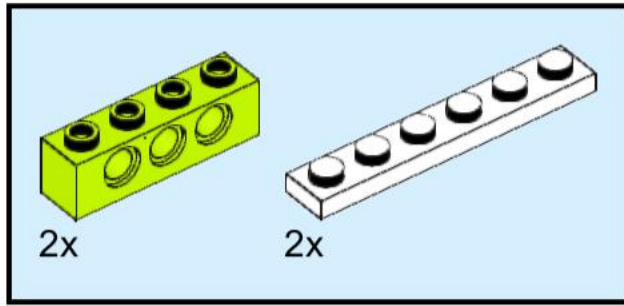

Technic Friends

14

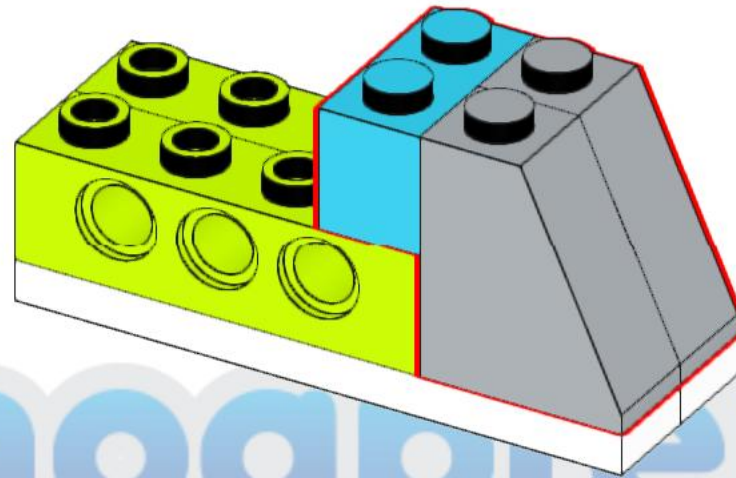
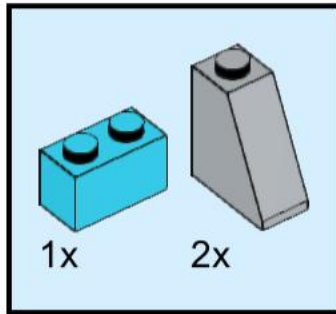

Tecnoaprendo

15

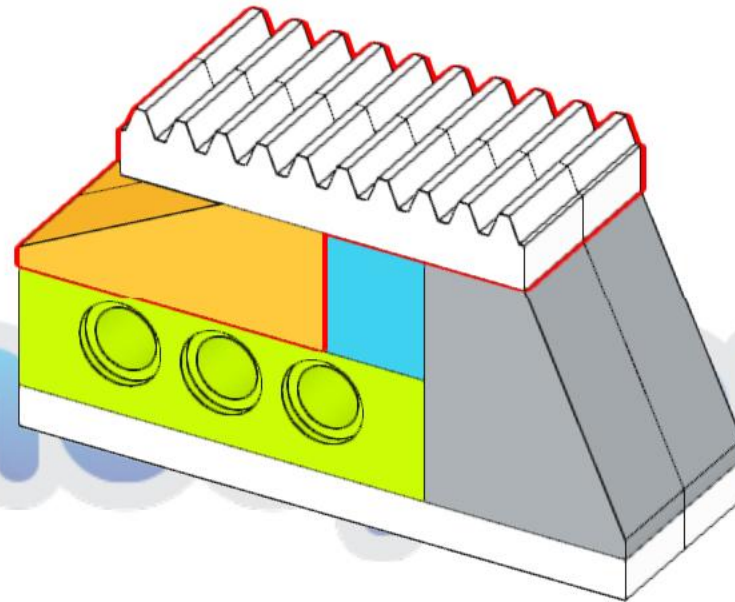
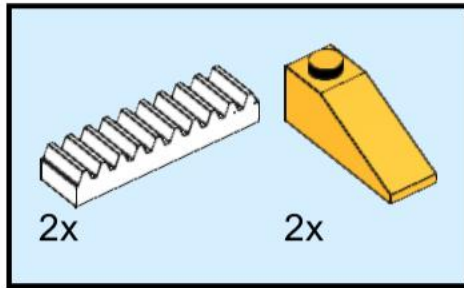

Tecnico Mondo



16

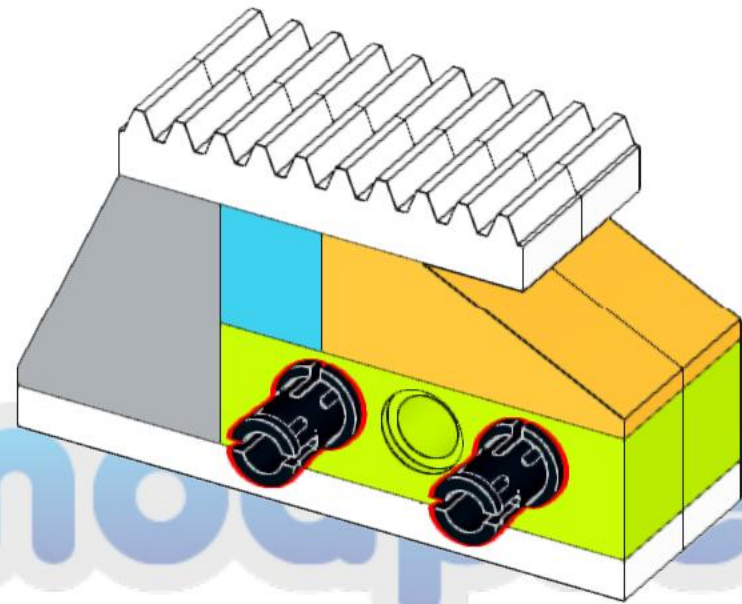

Tecnoparando

17

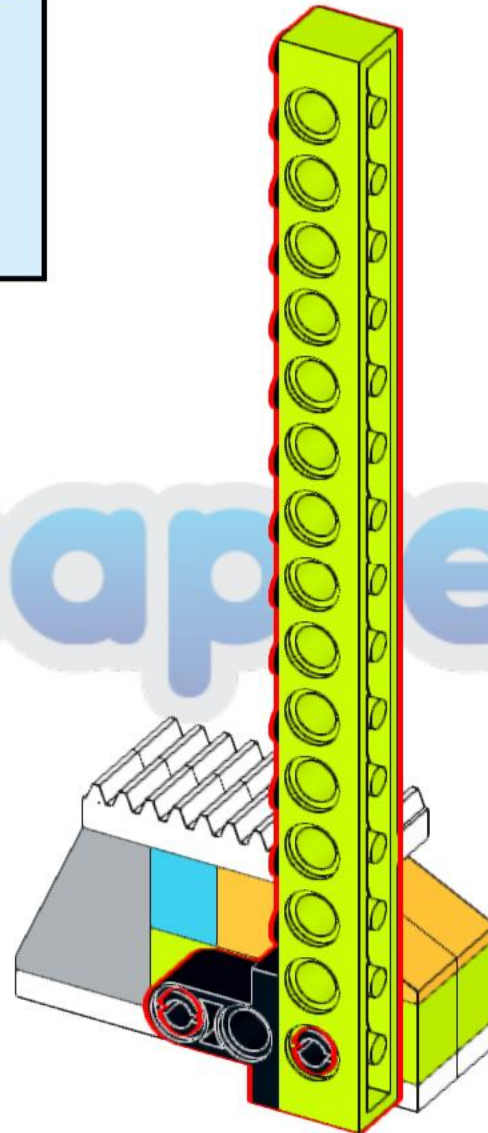
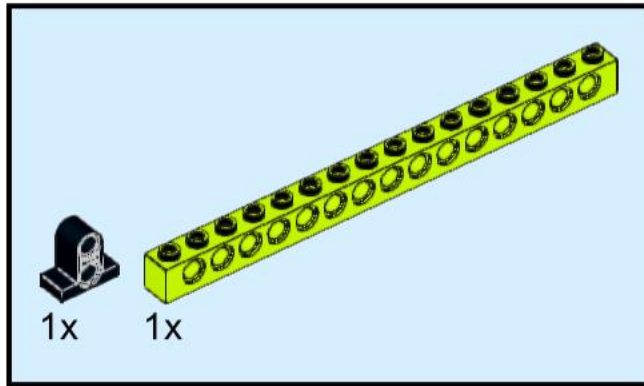

Tecnoappendo

18

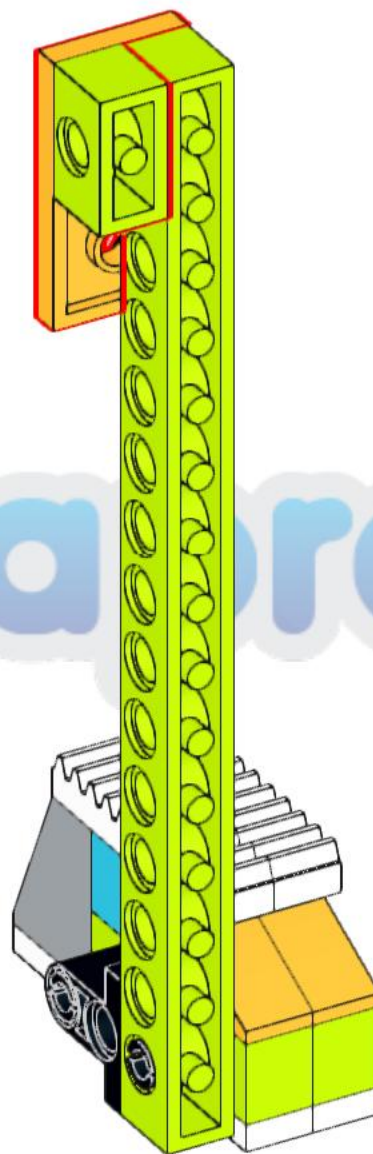
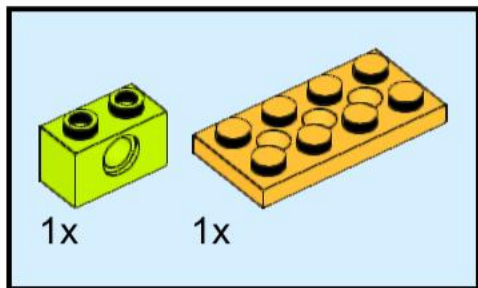

Tecnoaprendo

# 19

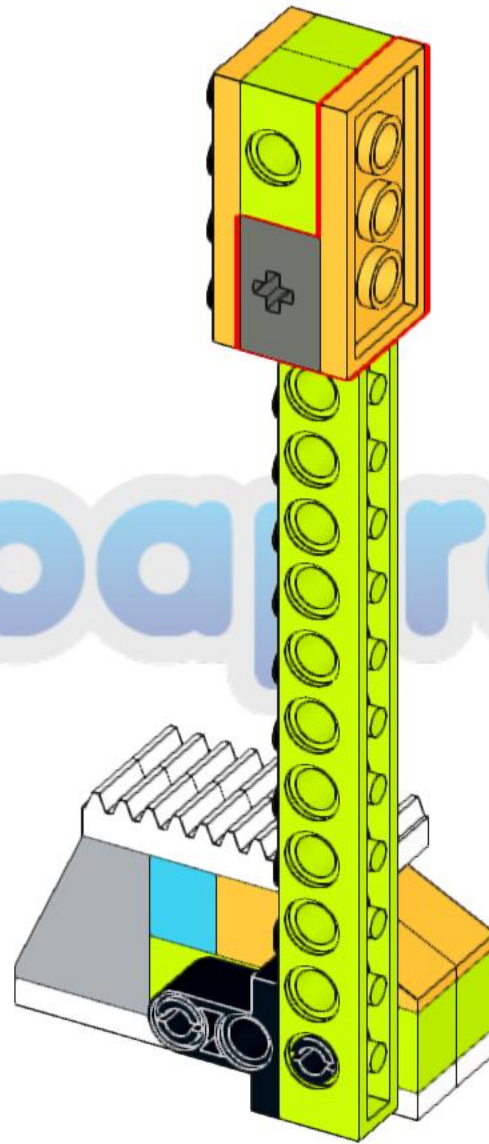
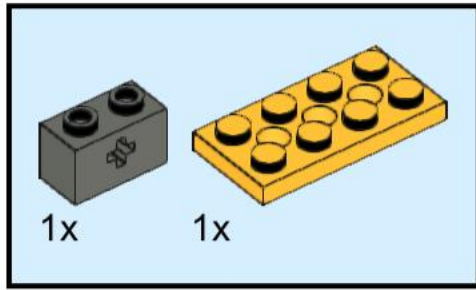

Tecnoaprendo

20

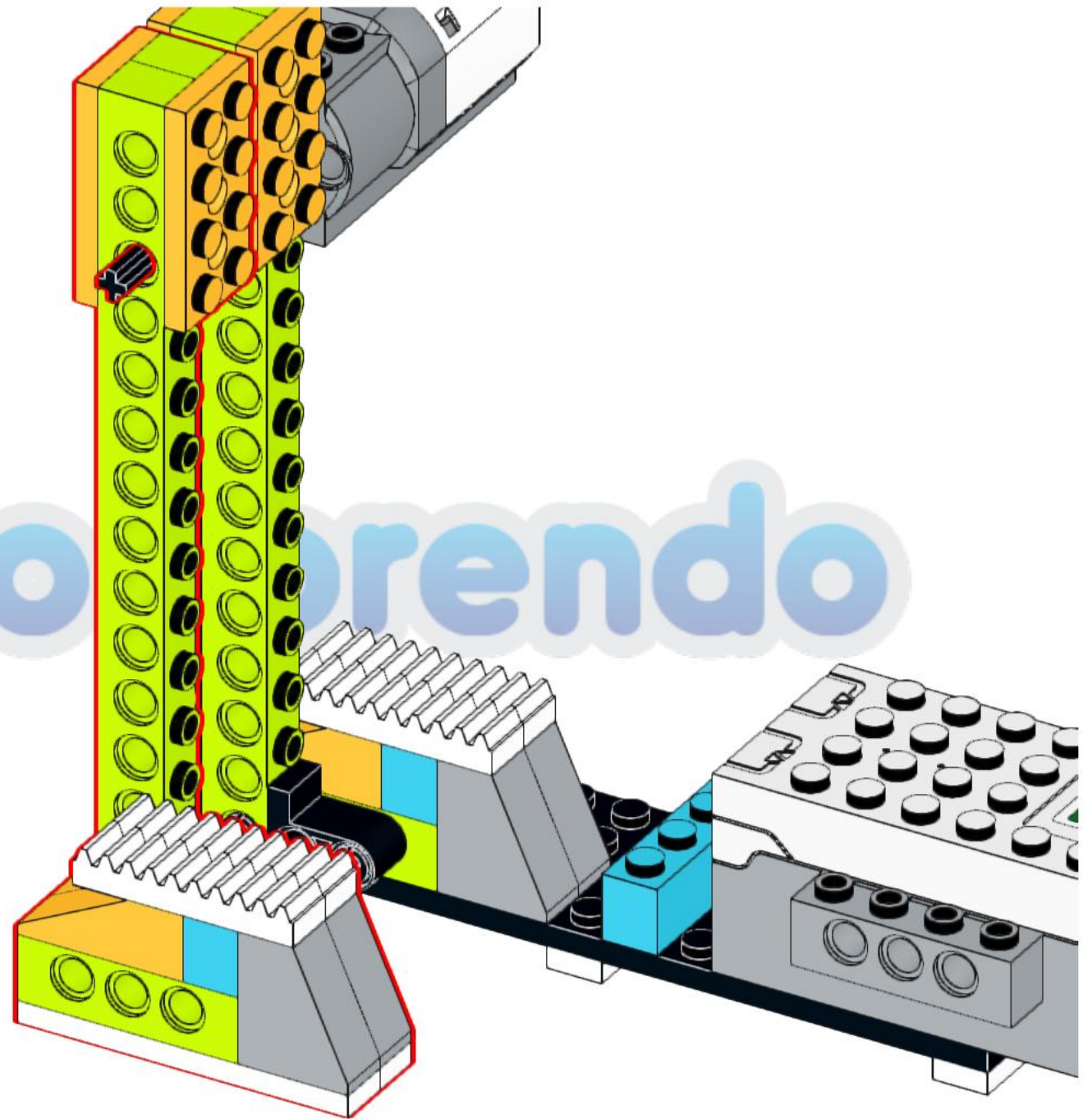

21

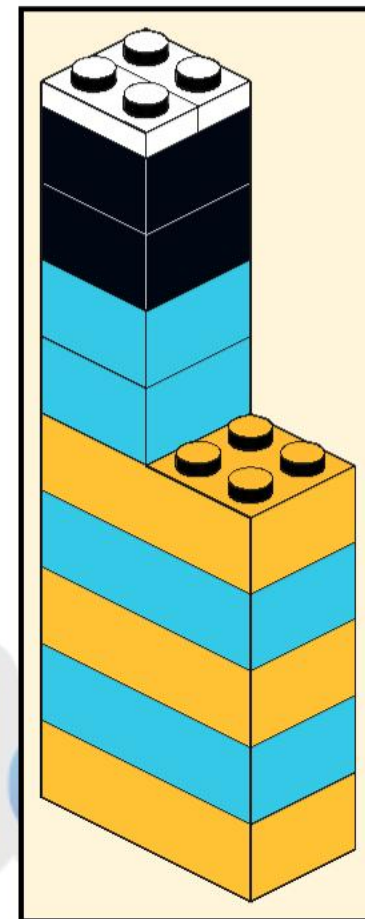
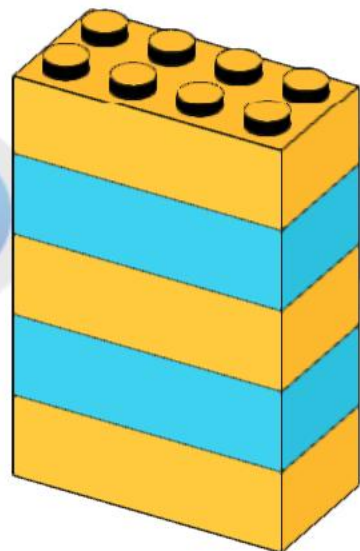
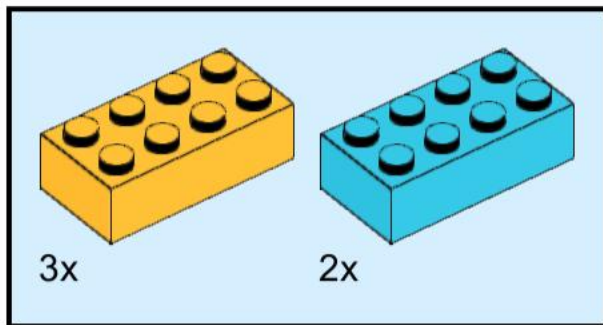

Tecnorend

22

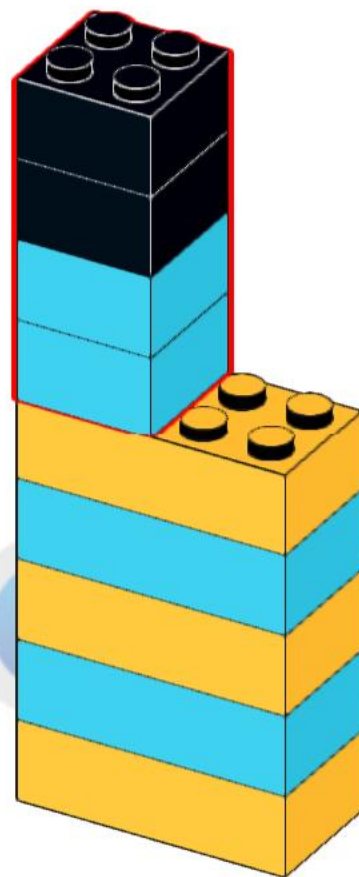
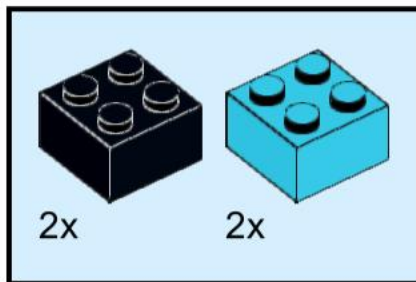

Tecnocendo

23

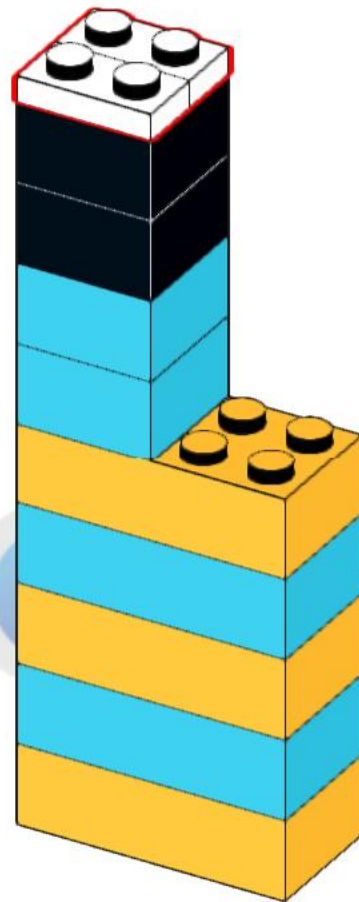
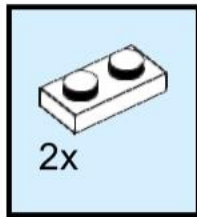

Tecnocendo



24

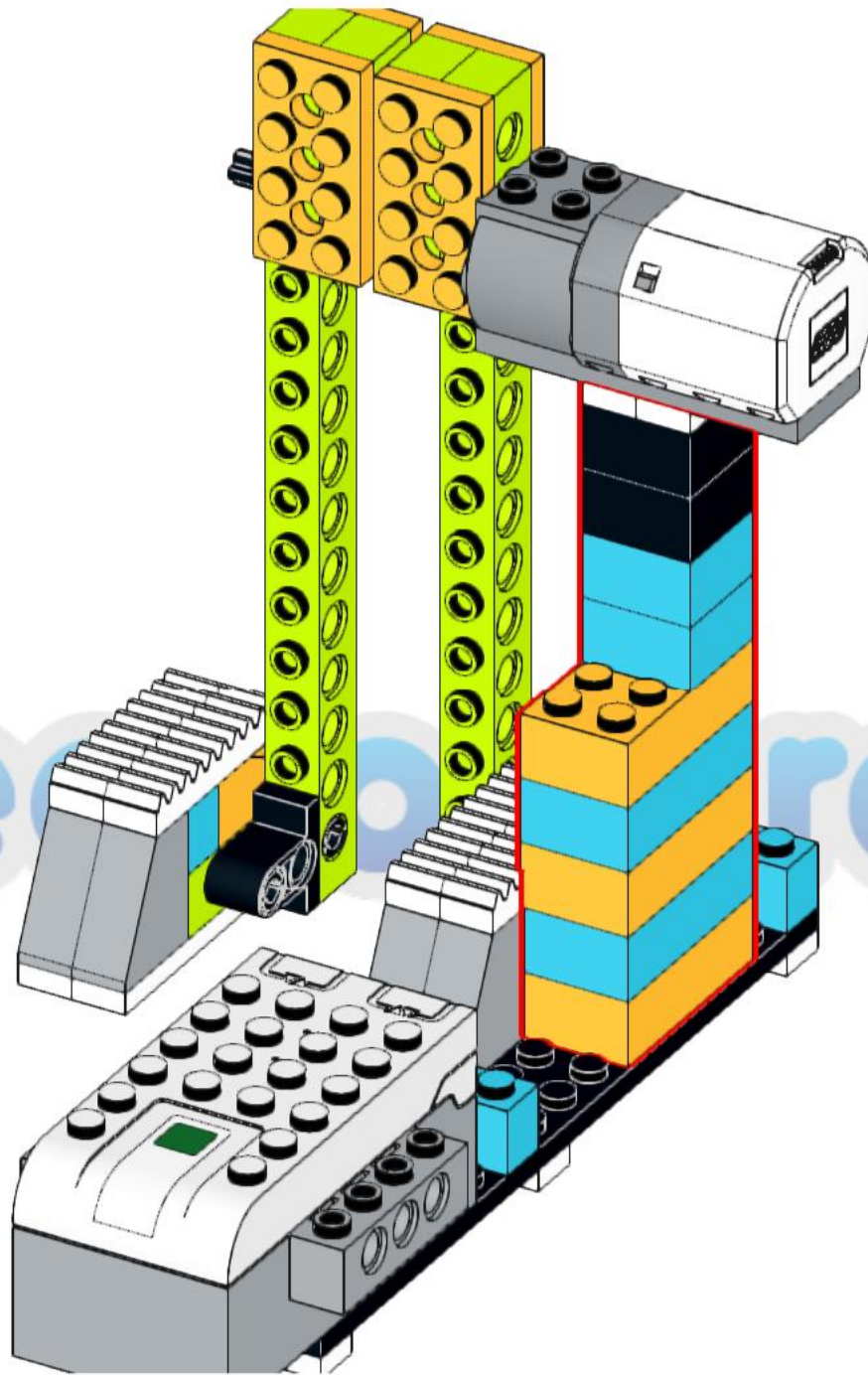

# 25

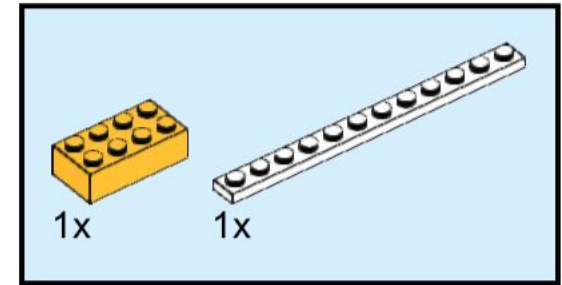
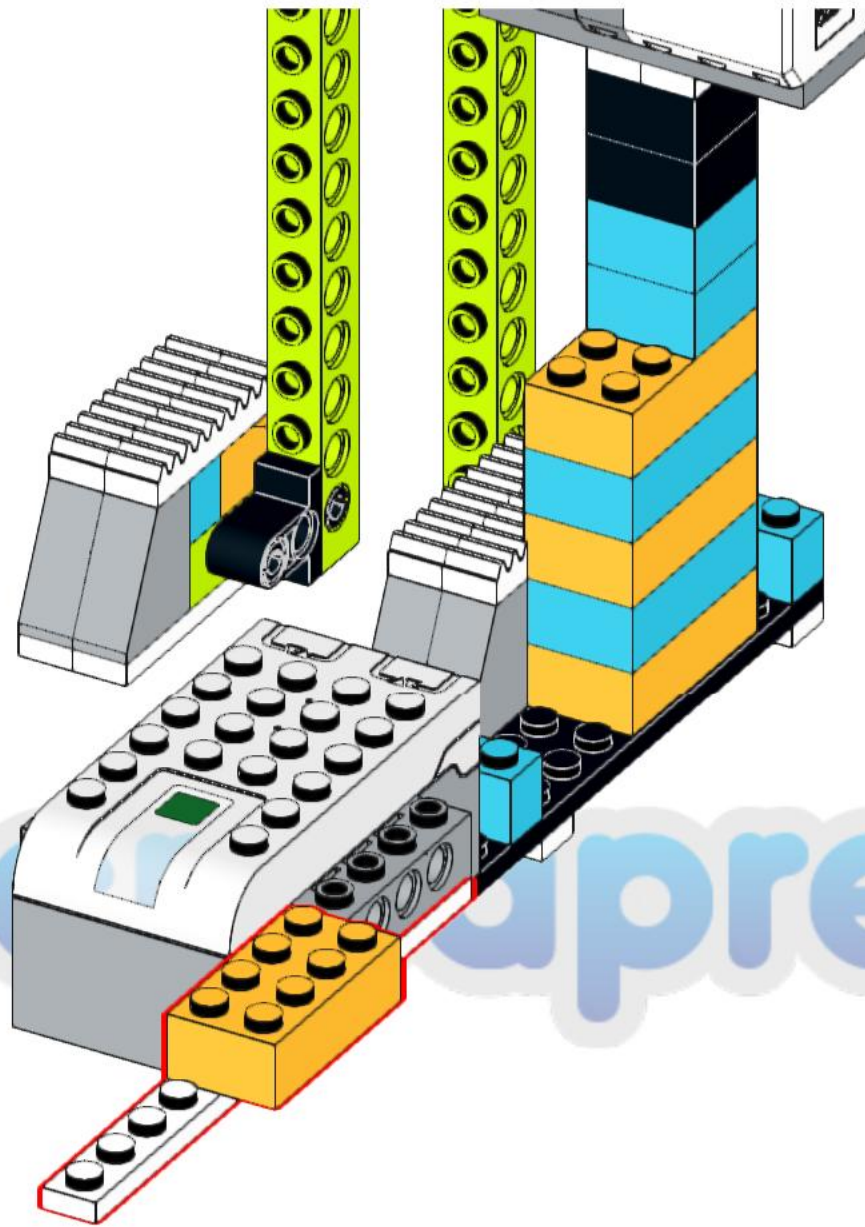

Tec  
aprendo

# 26

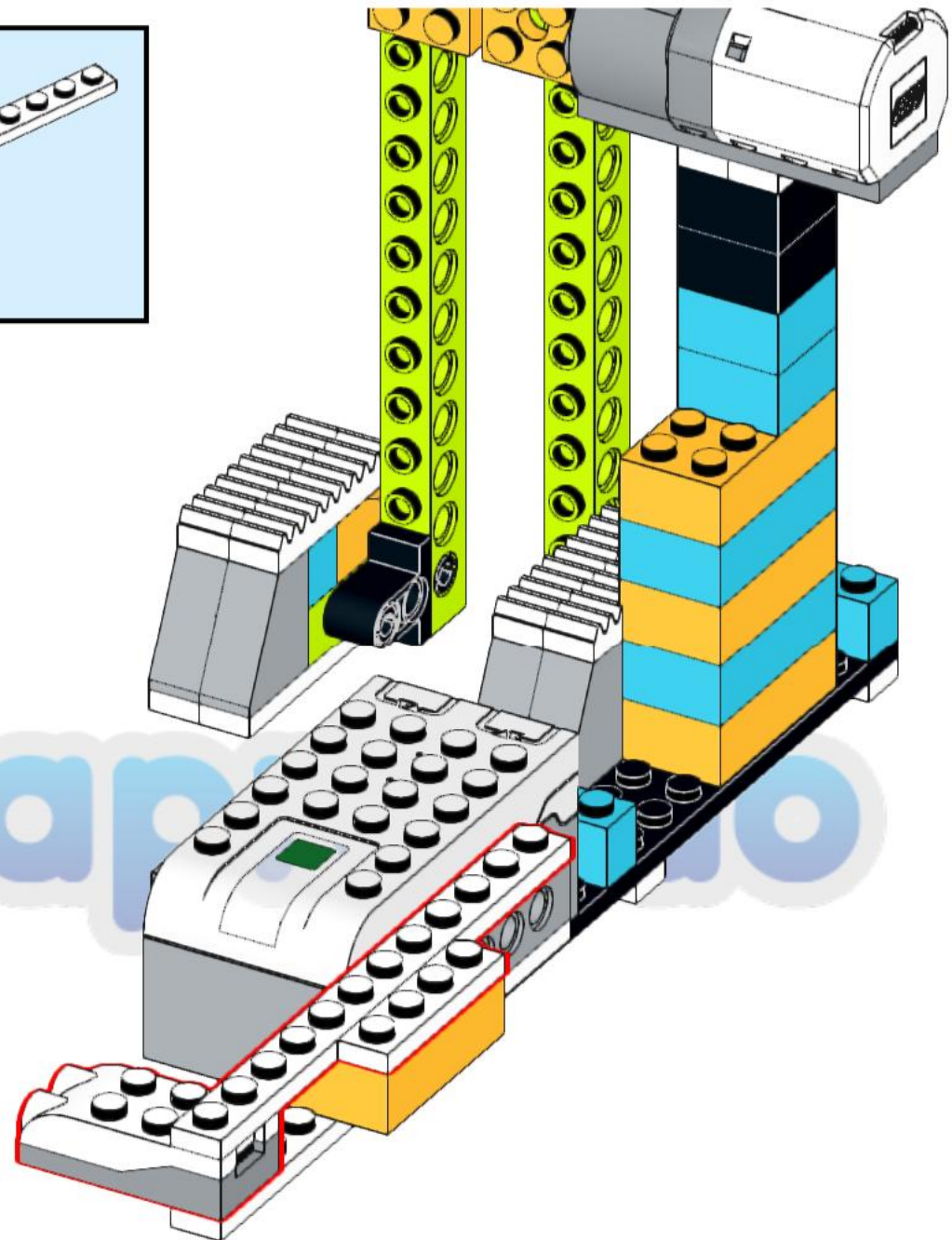
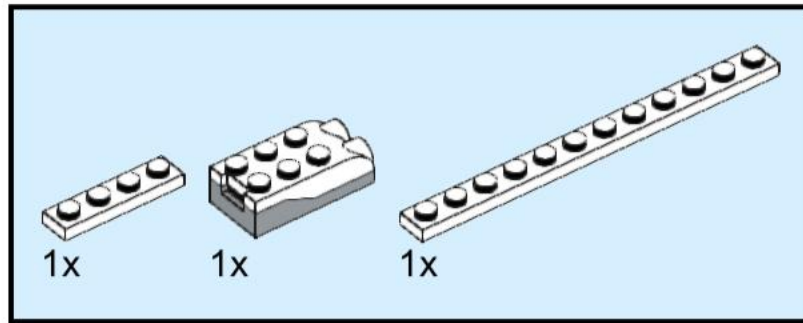

27

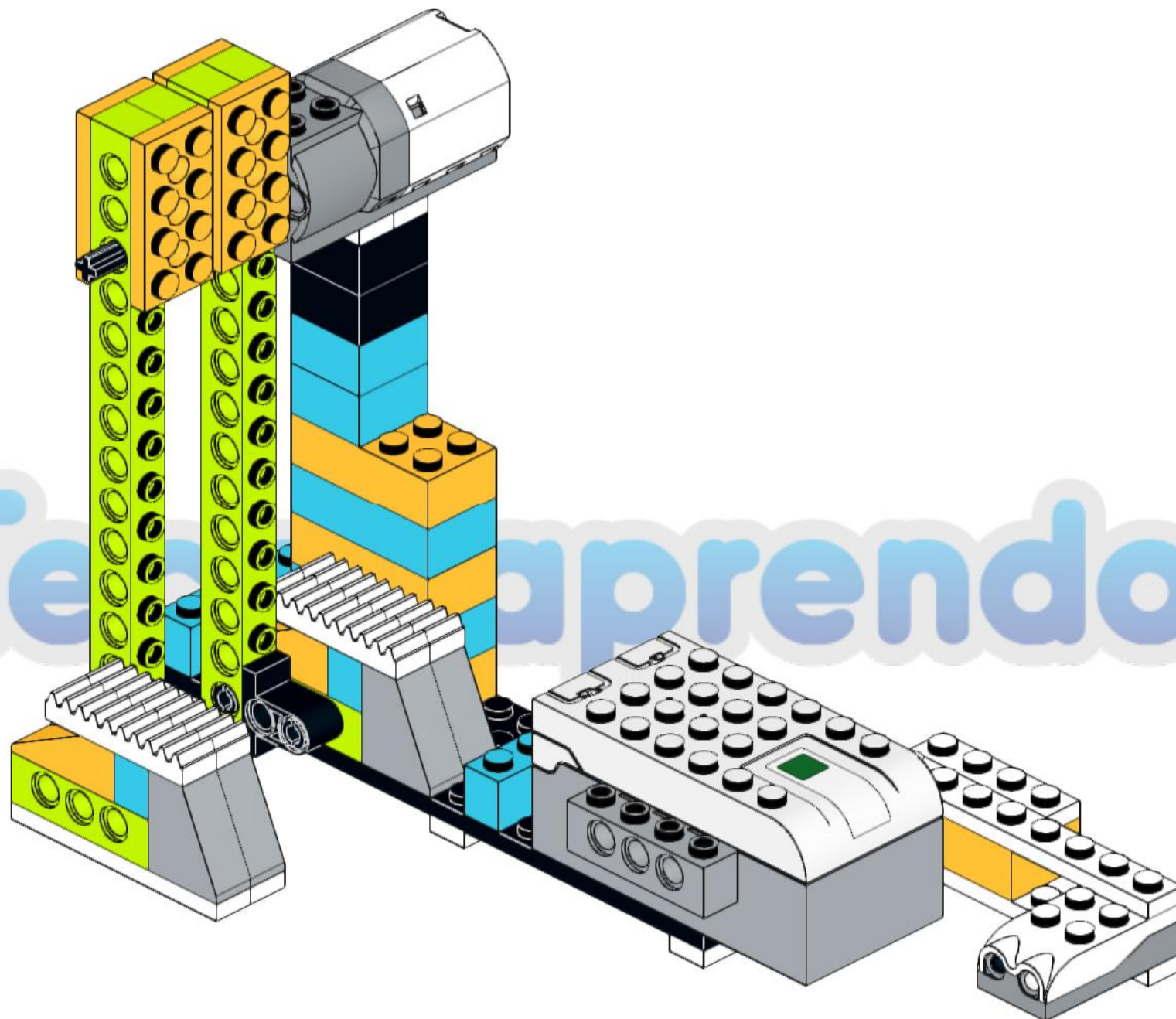

Tecnoaprendo



Sequence of five blocks:
 

- Yellow block with a green play button icon.
- Yellow block with an hourglass icon.
- Green block with a motor icon and a white arrow pointing right.
- Green block with a motor icon and a white circular arrow icon.
- Green block with a motor icon and an hourglass icon.

 Below the second and fifth blocks are blue labels with the numbers 8 and 3 respectively. Below the second block is also an orange icon of a LEGO Technic brick with a white arrow pointing to it.





4x  
2780, 11



2x  
32530, 11



2x  
3003, 11



1x  
3706, 11



2x  
4282, 11



1x  
32064, 85



4x  
60481, 86

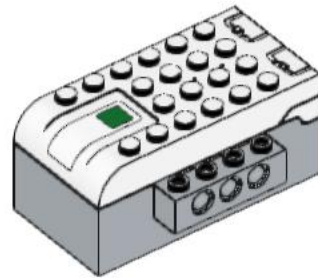

1x  
19071c01, 86



2x  
3023, 1



4x  
3743, 1



4x  
3710, 1



1x  
20844, 1

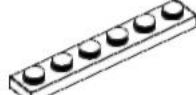

2x  
3666, 1

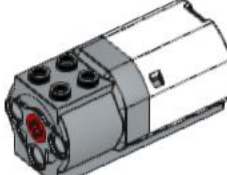

1x  
21980, 1

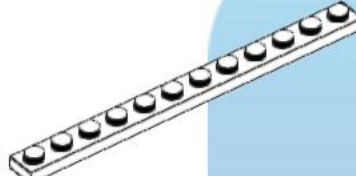

2x  
60479, 1

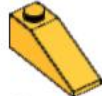

4x  
4286, 110

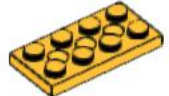

4x  
3709b, 110

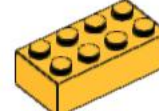

4x  
3001, 110



3x  
3700, 34



4x  
3701, 34

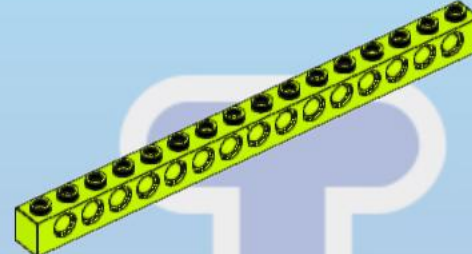

2x  
3703, 34



2x  
3004, 156



2x  
3003, 156

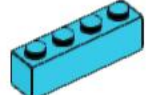

2x  
3010, 156

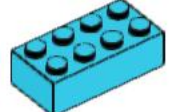

2x  
3001, 156

