

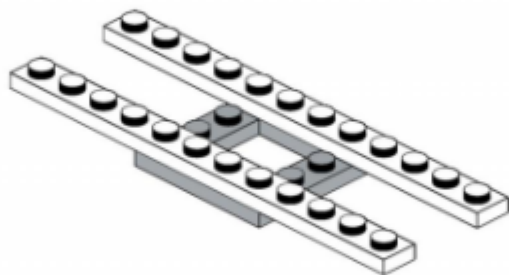

NOT JUST  BRICKS

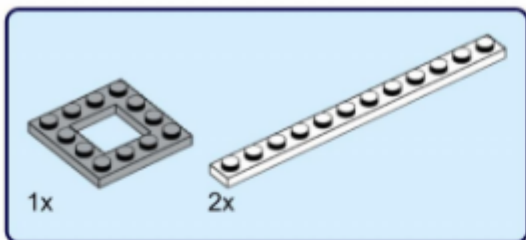

1



2

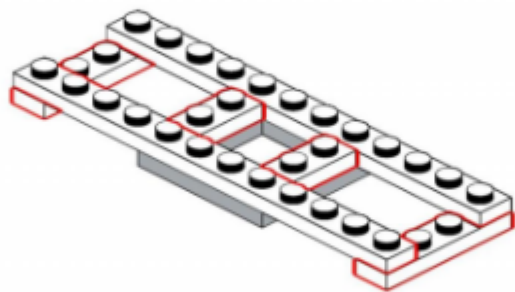
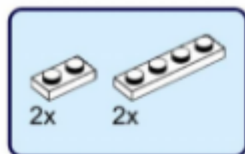

3

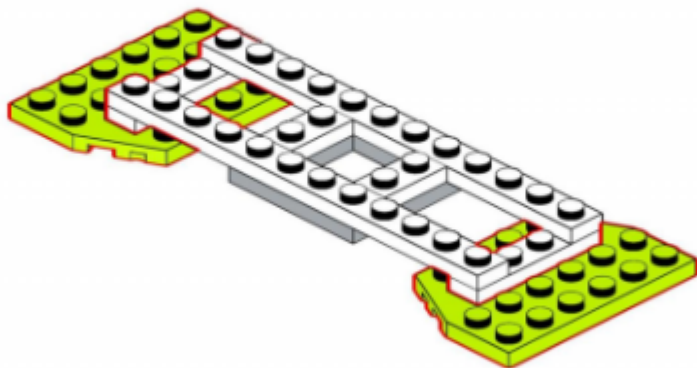
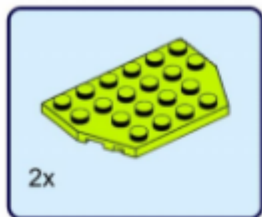

4

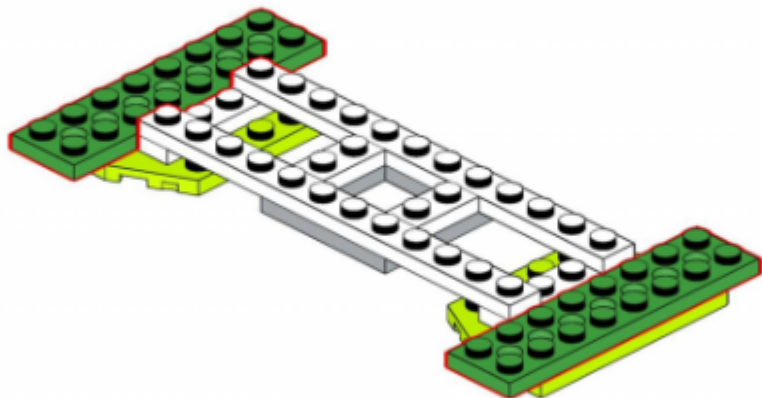
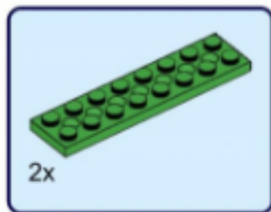

5

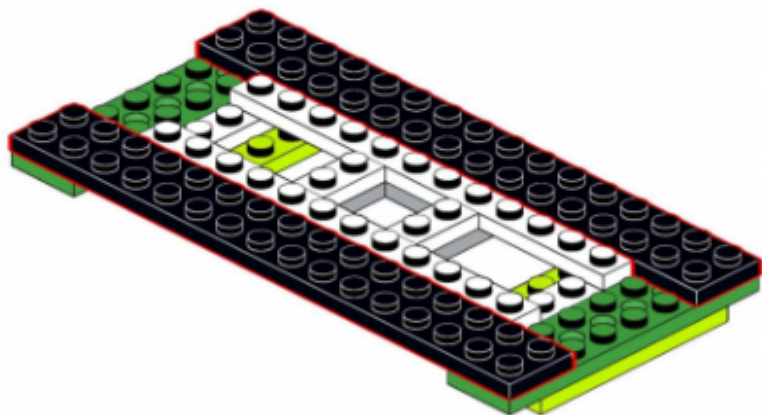
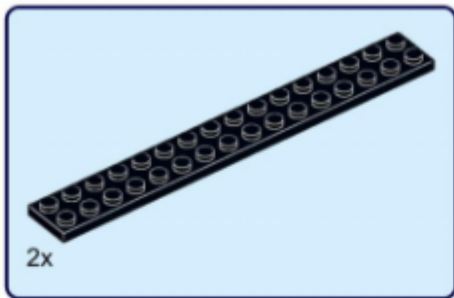

6

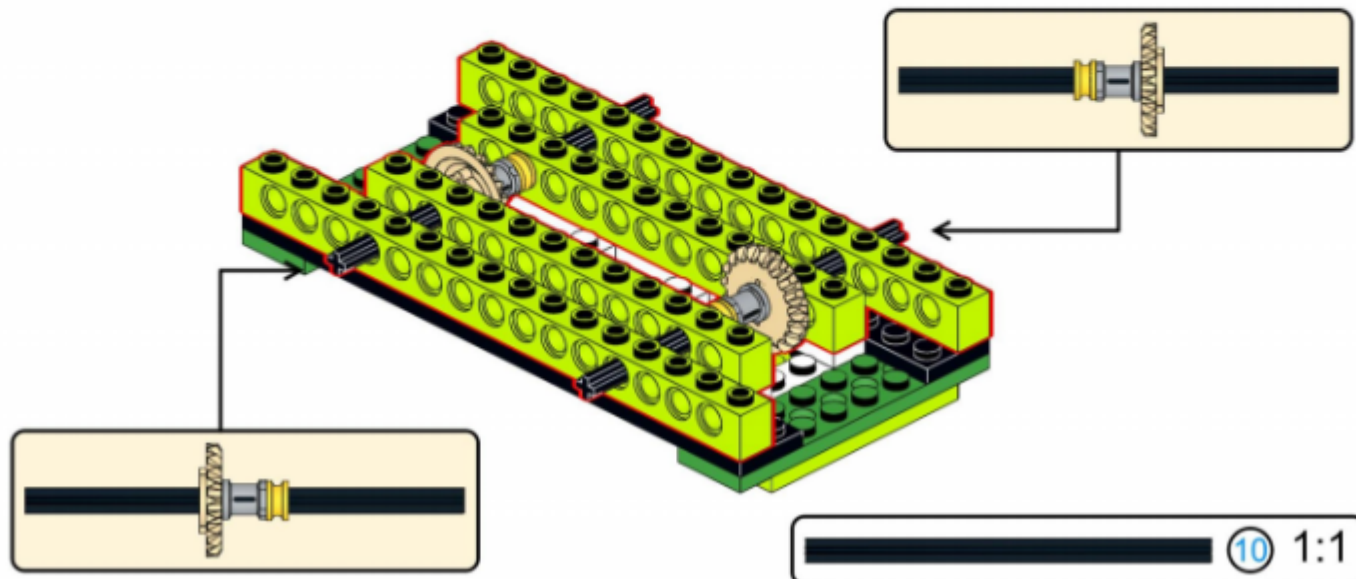
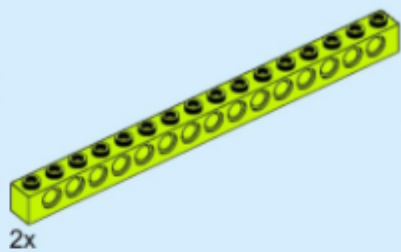
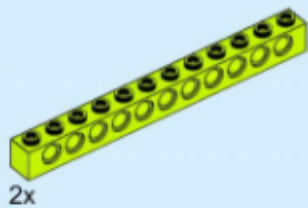

7

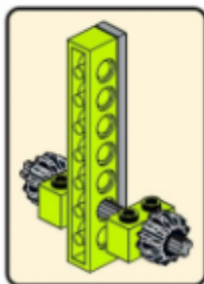
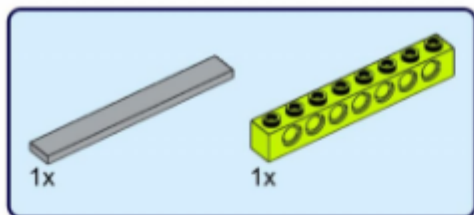

8

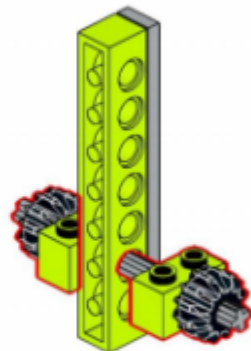
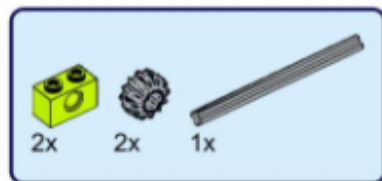

9

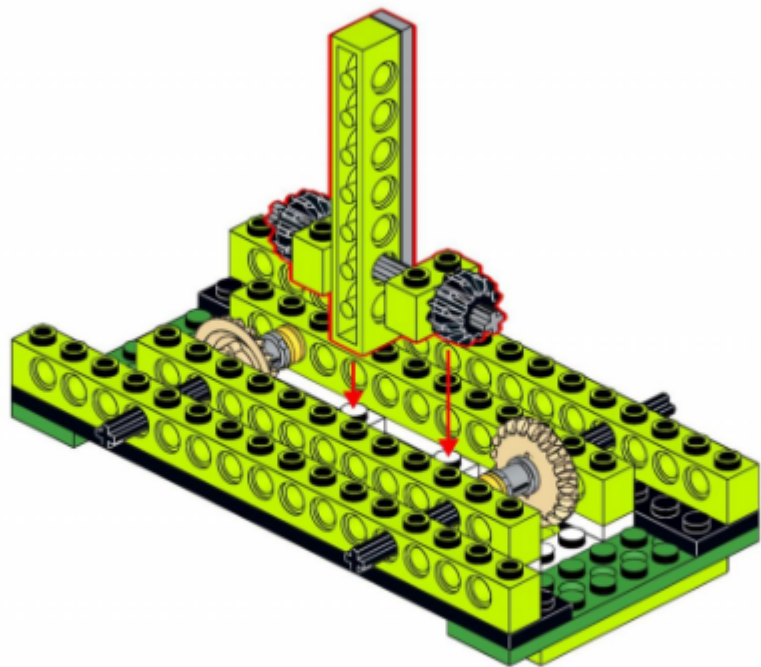

10

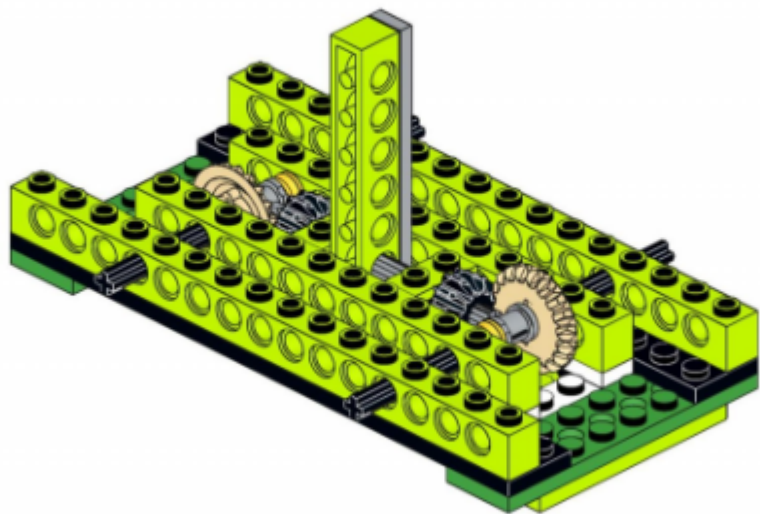

11

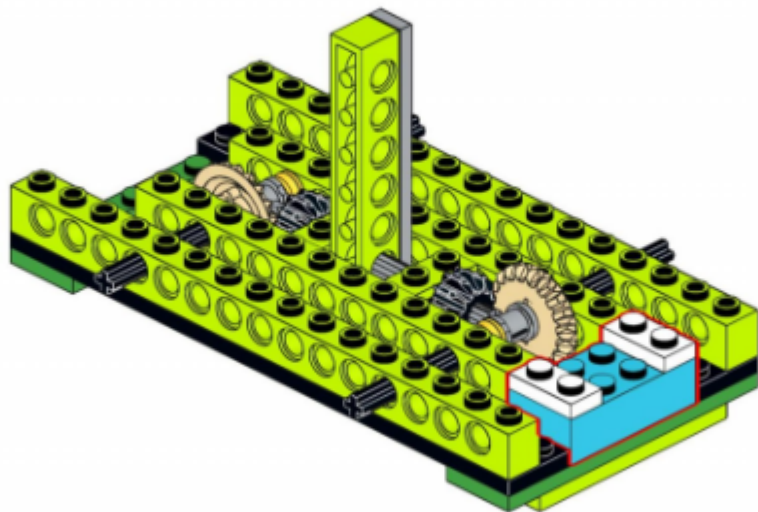
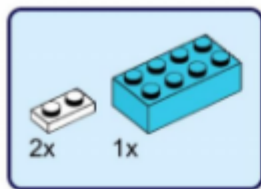

12

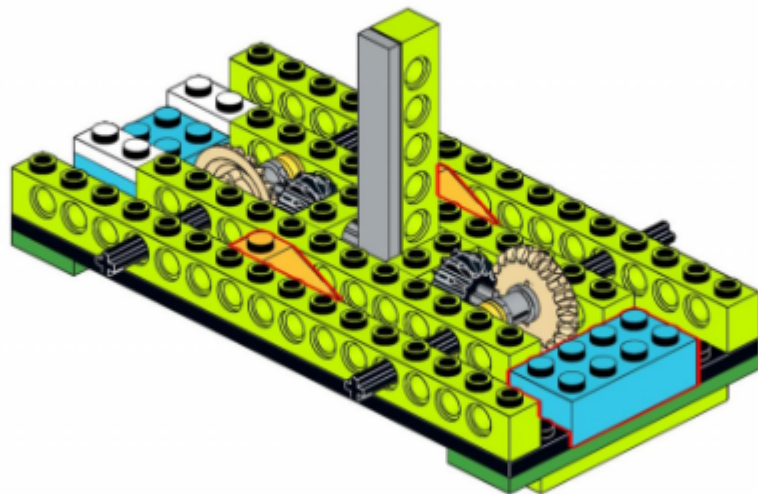
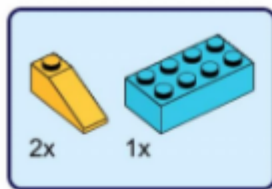

13

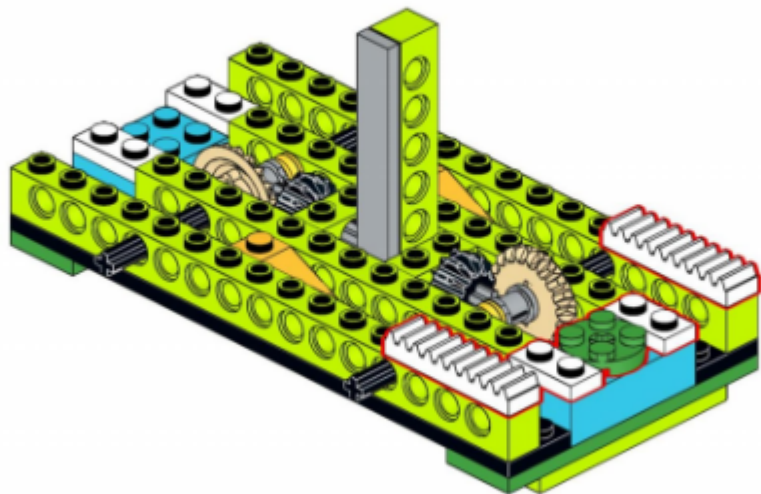
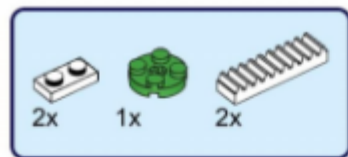

14

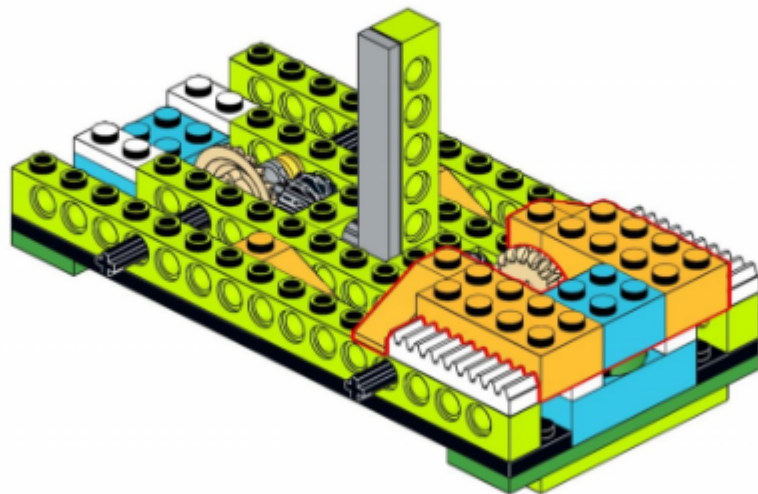
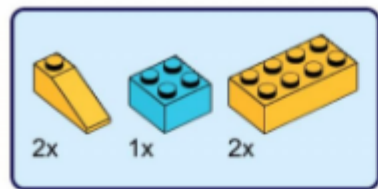

15

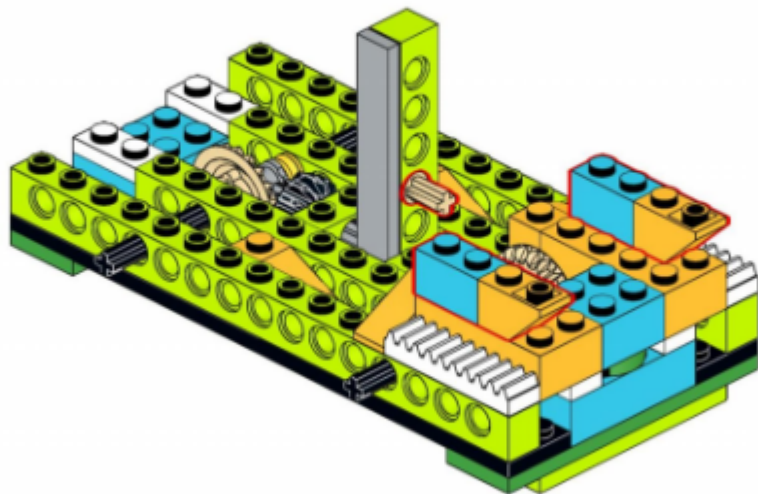
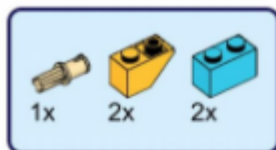

16

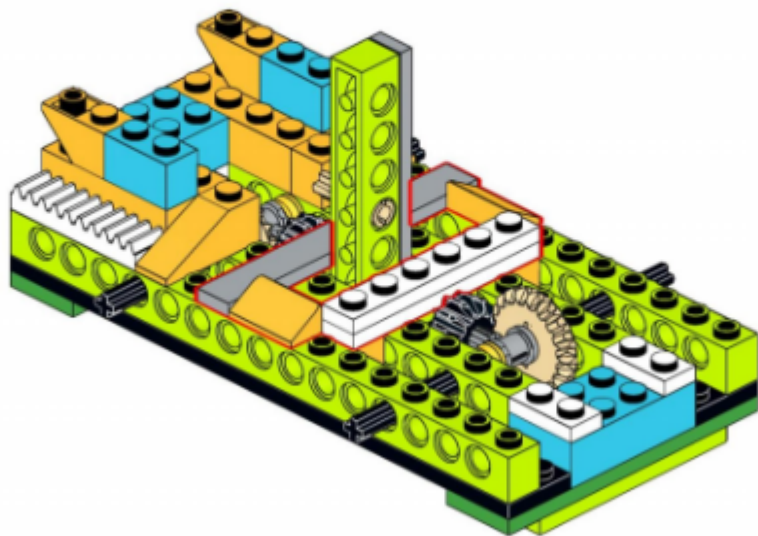
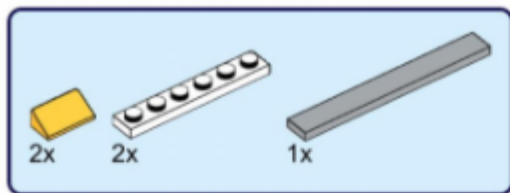

17

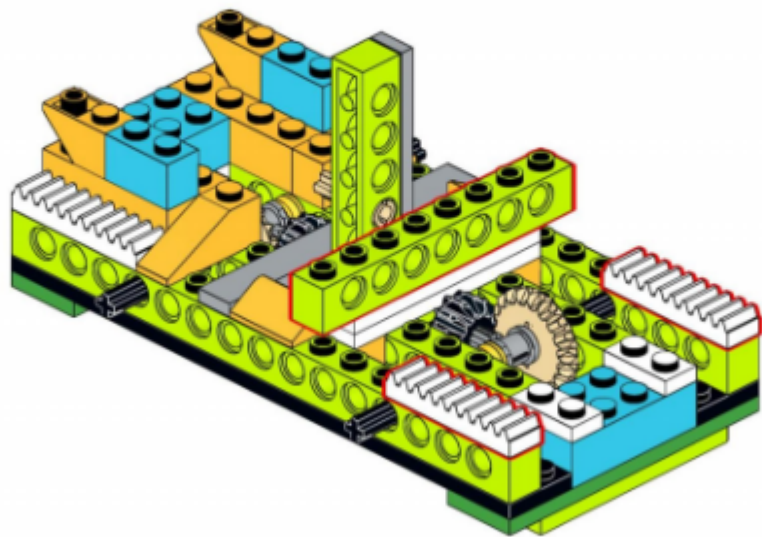
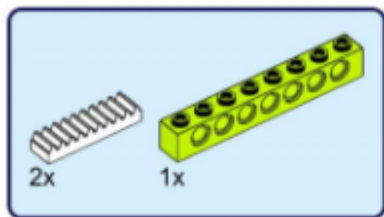

18

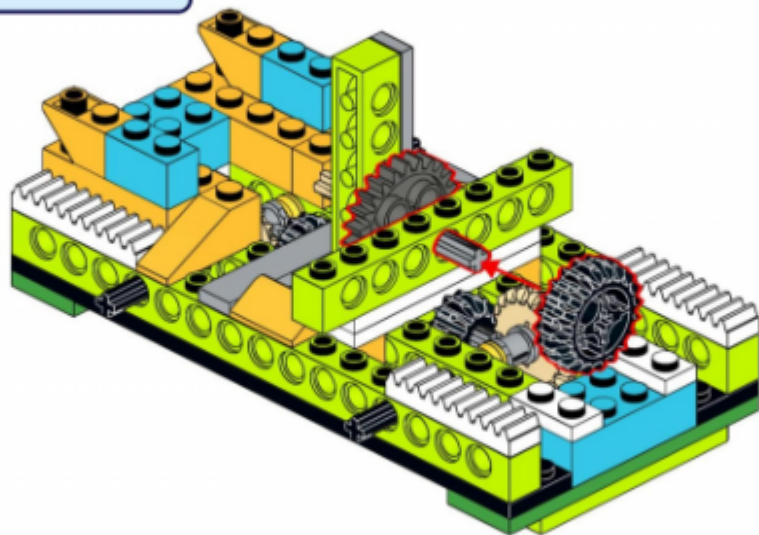
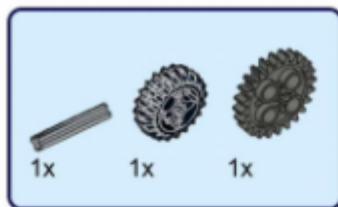

19

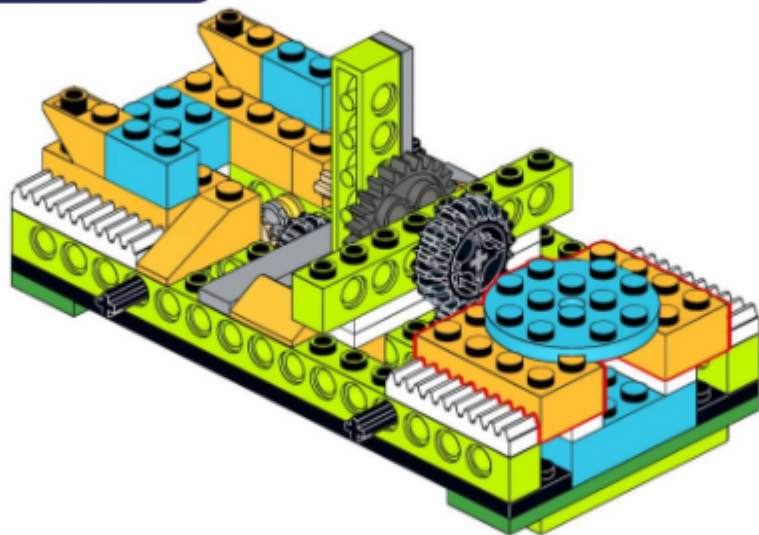
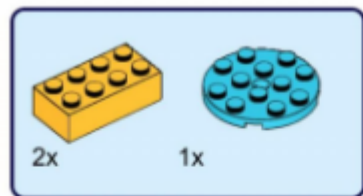

20

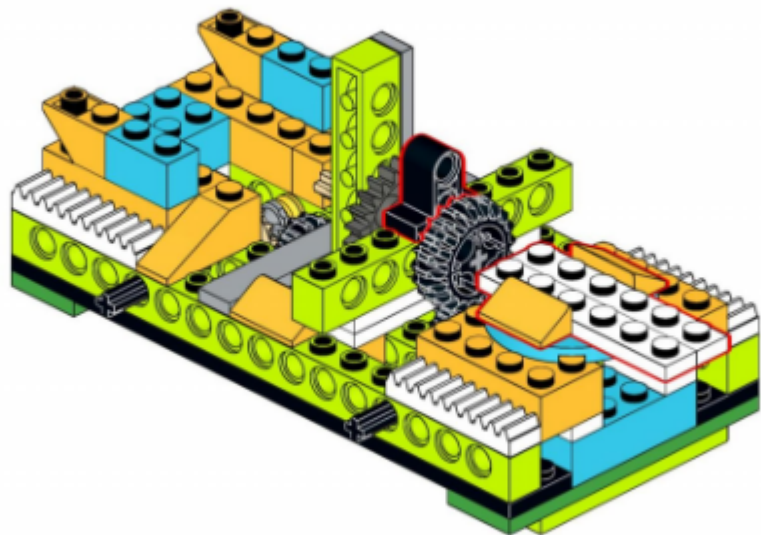
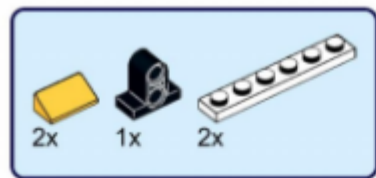

21

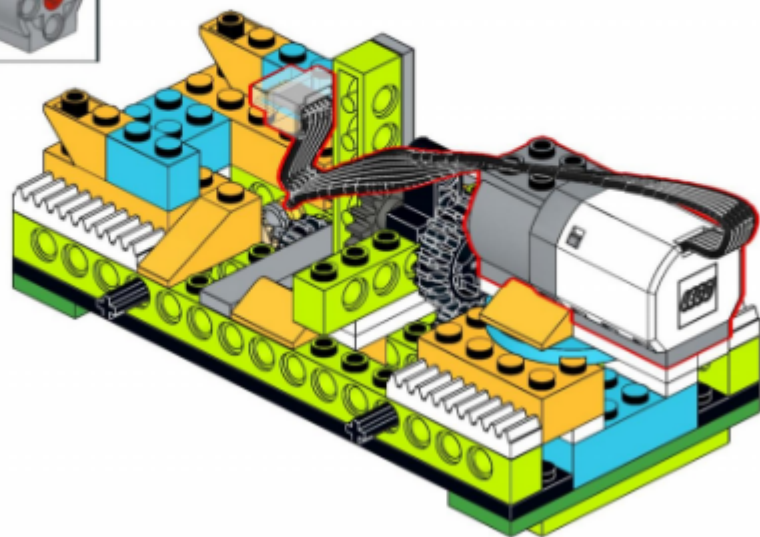
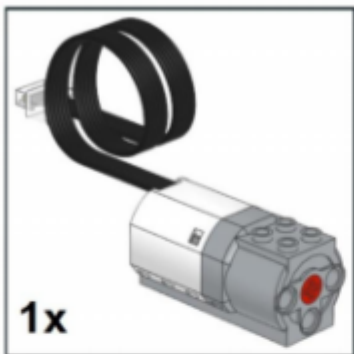

22

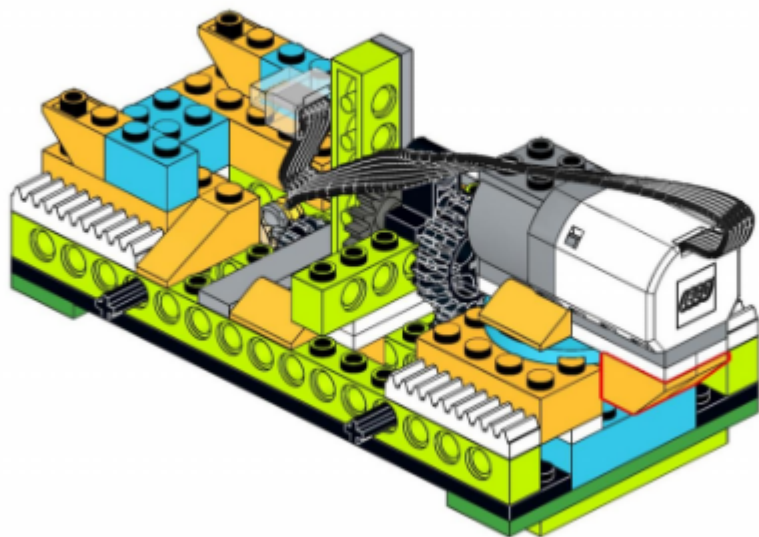

23

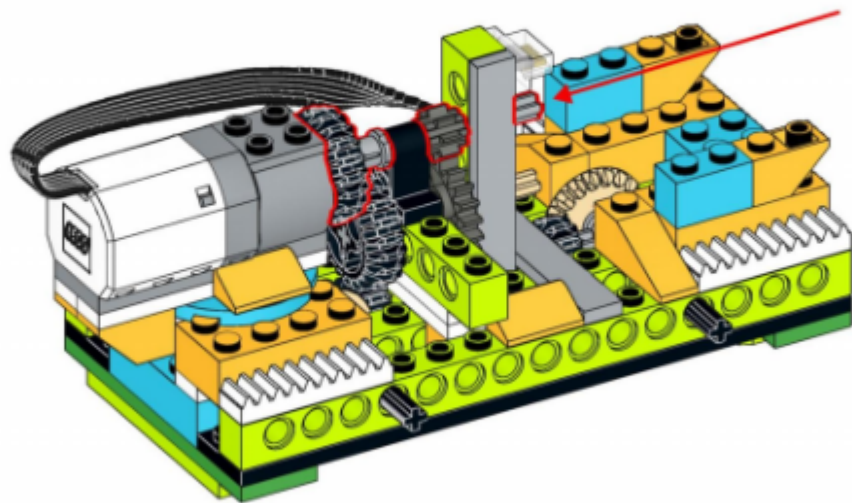
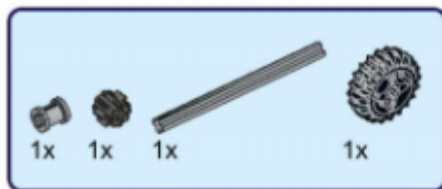

24

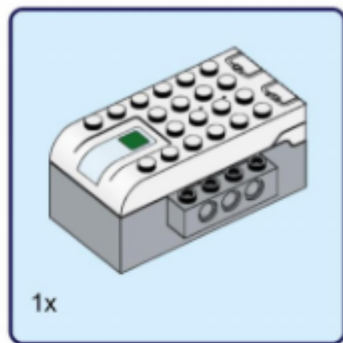
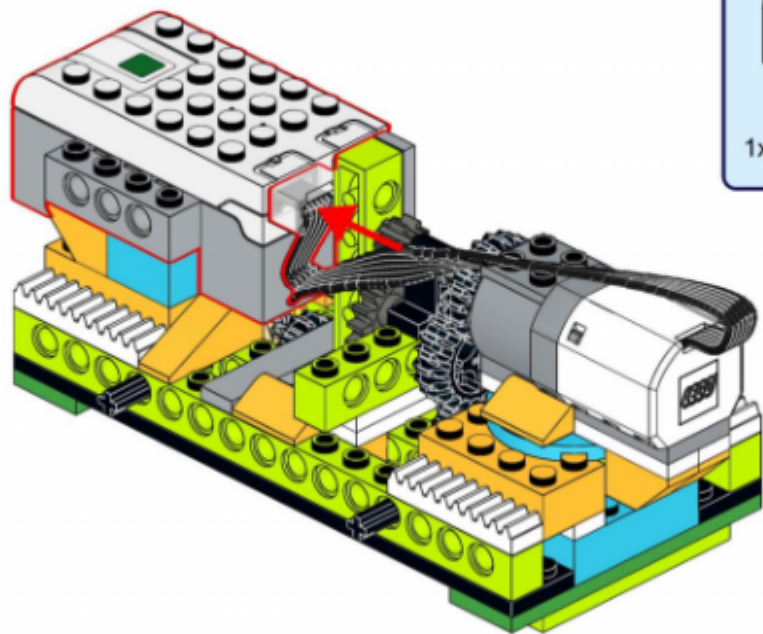

25

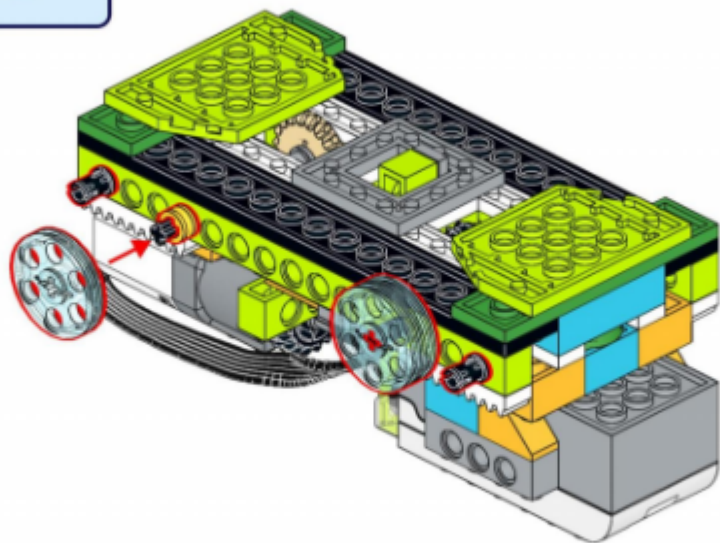

26

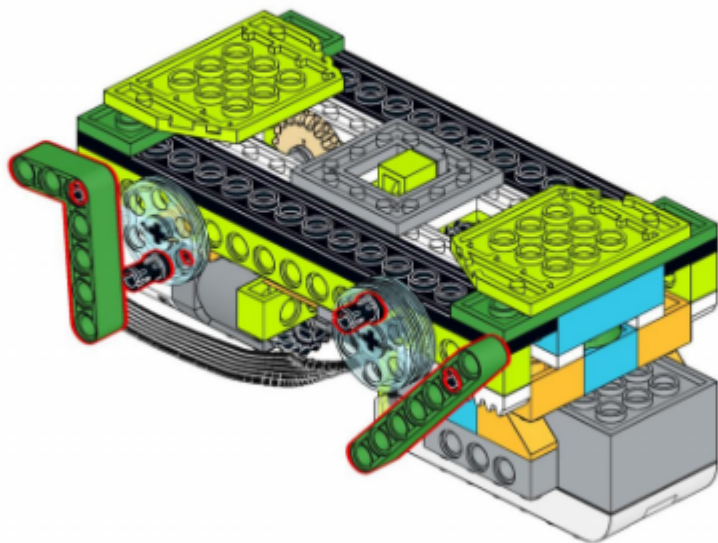
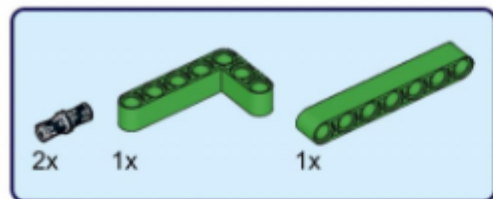

27

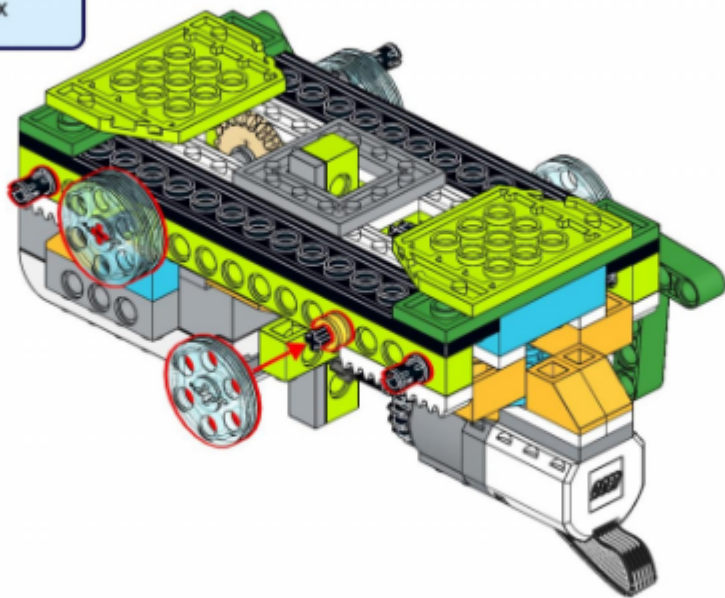

28

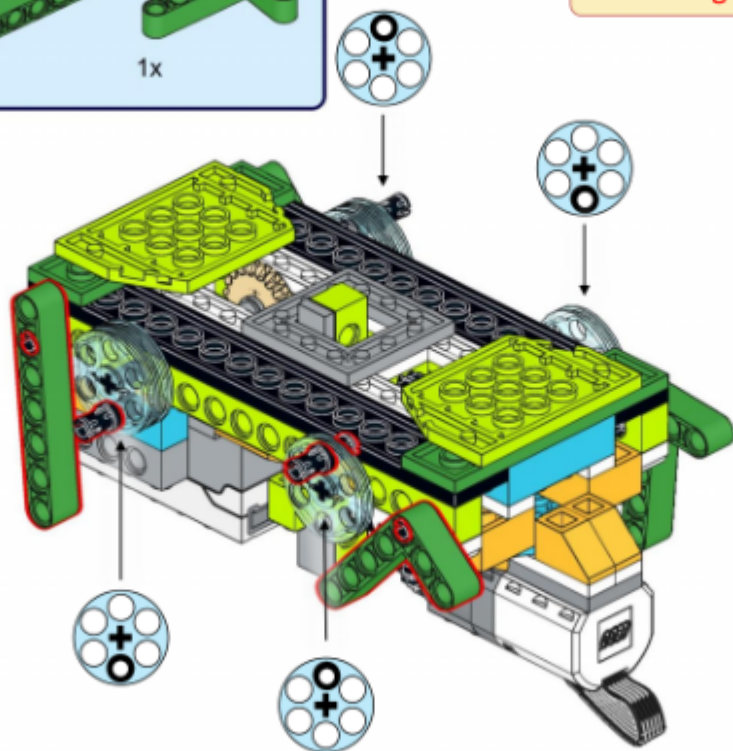
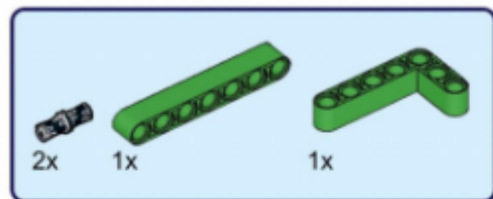

Be careful! The connector position must be exactly as showed to have a right walking motion

29

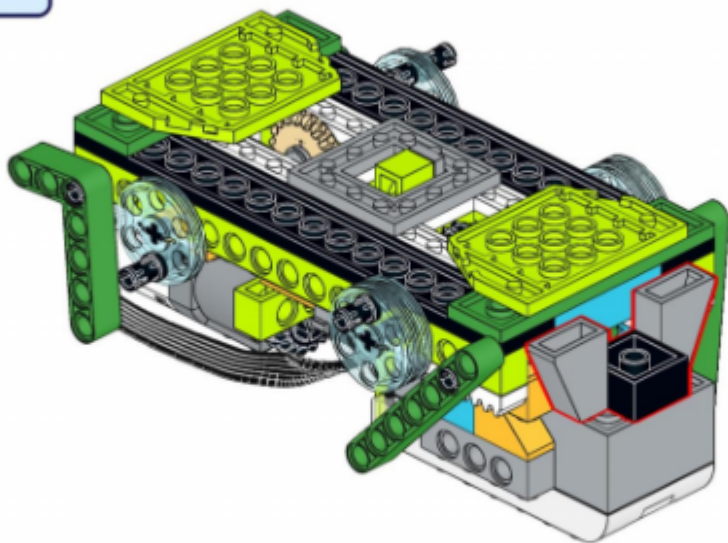

30

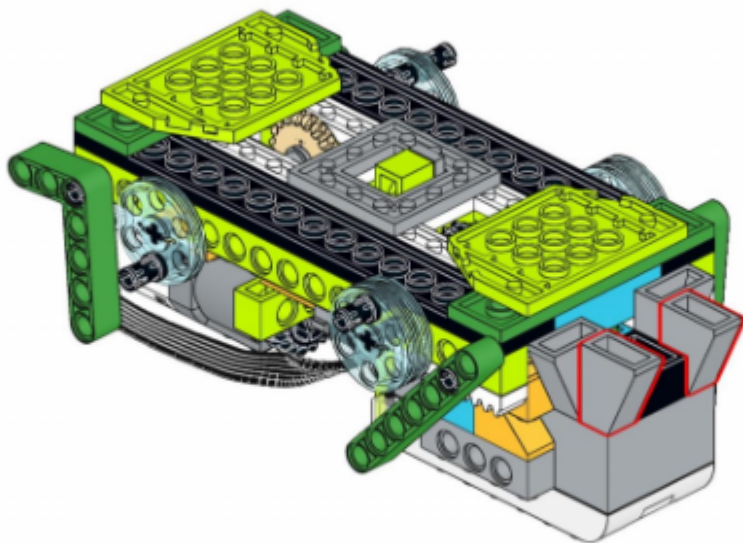
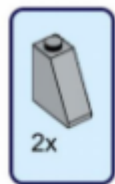

31

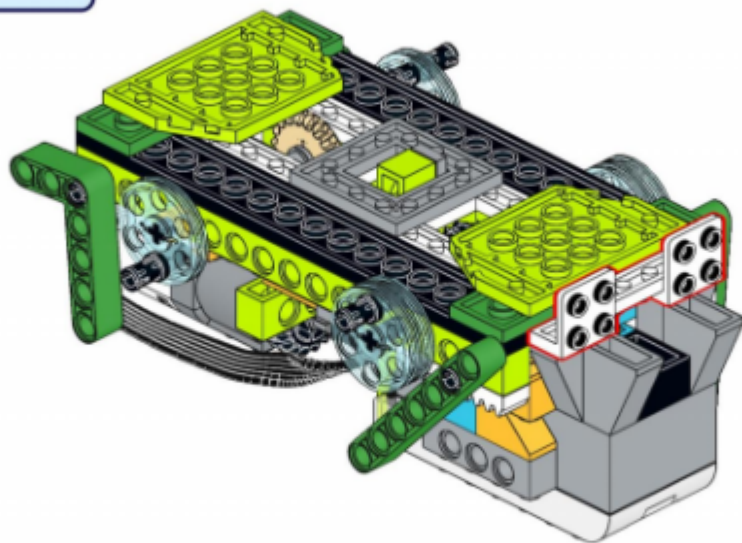
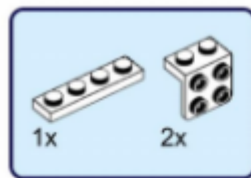

32

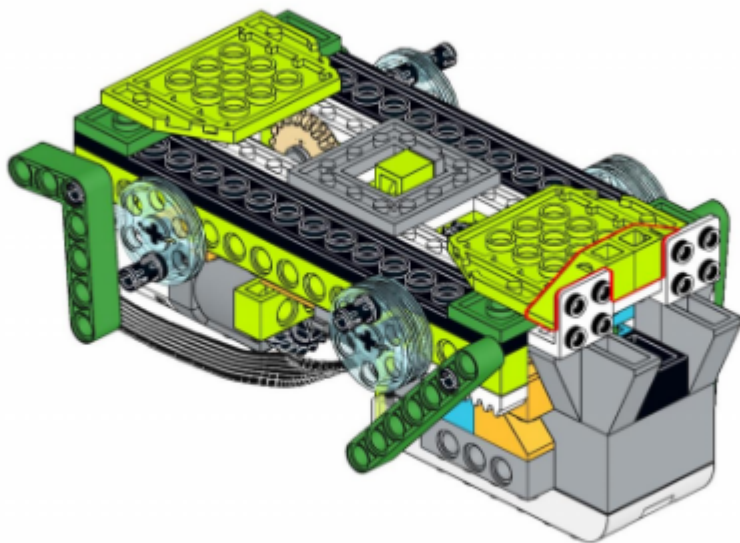

33

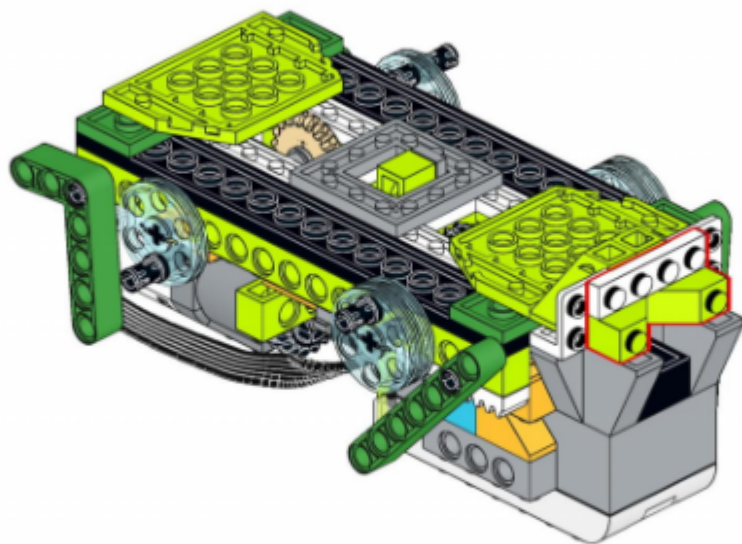
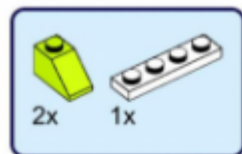

34

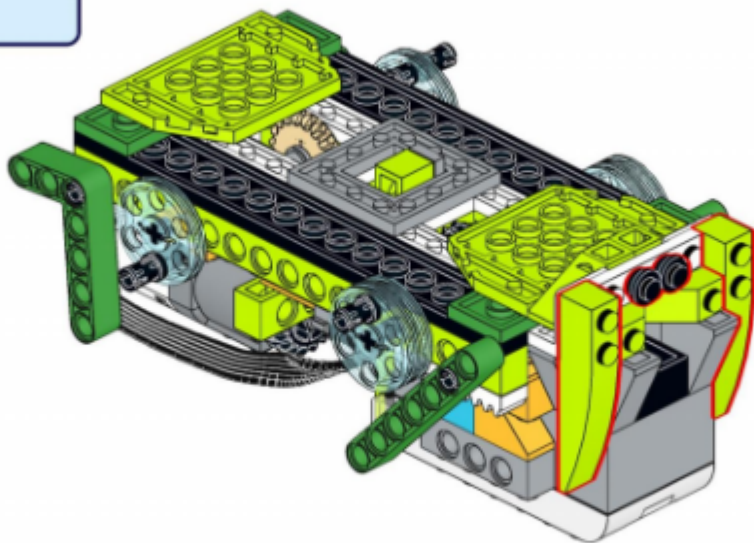

35

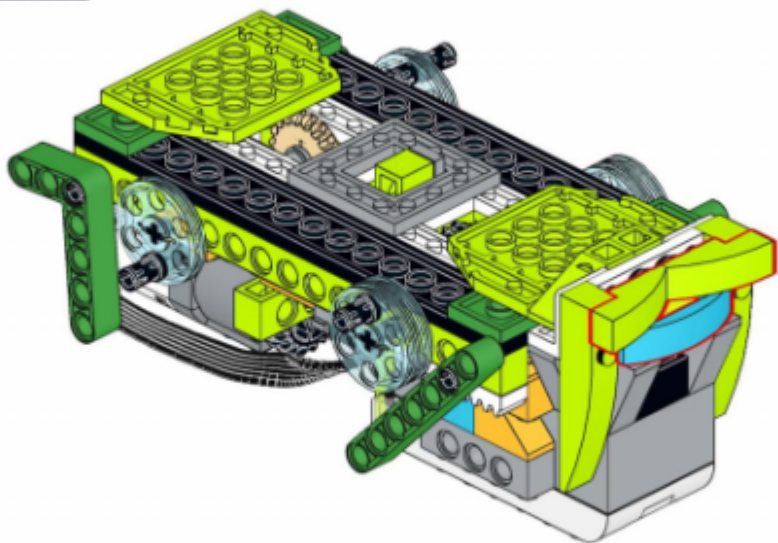
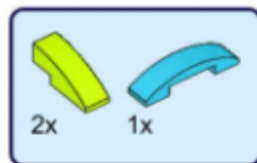

36

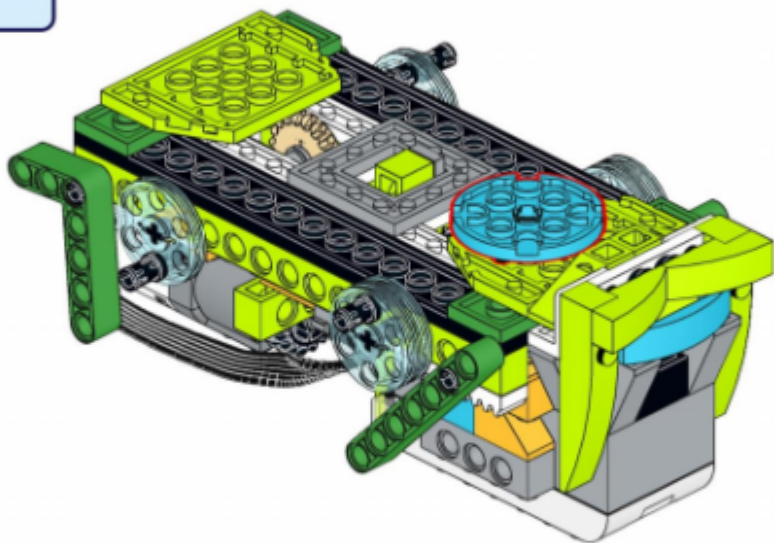
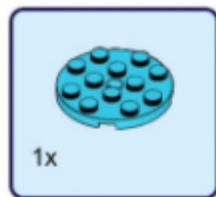

37

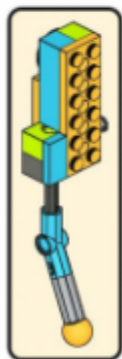
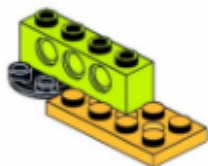
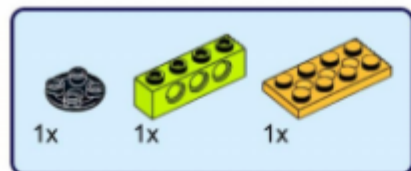

38

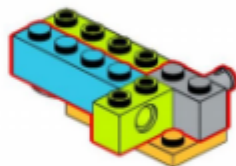
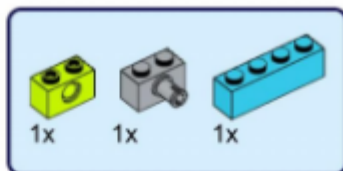

39

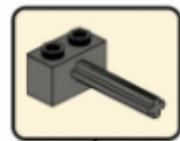
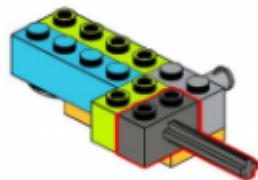
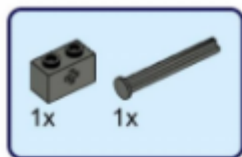

40

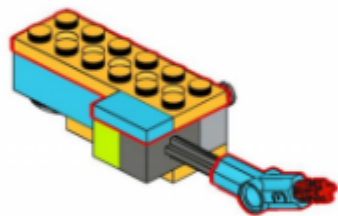

41

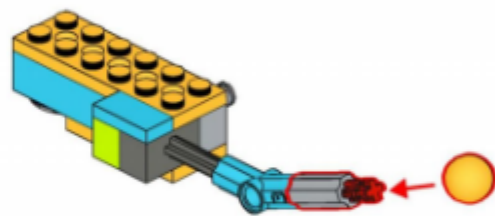

42

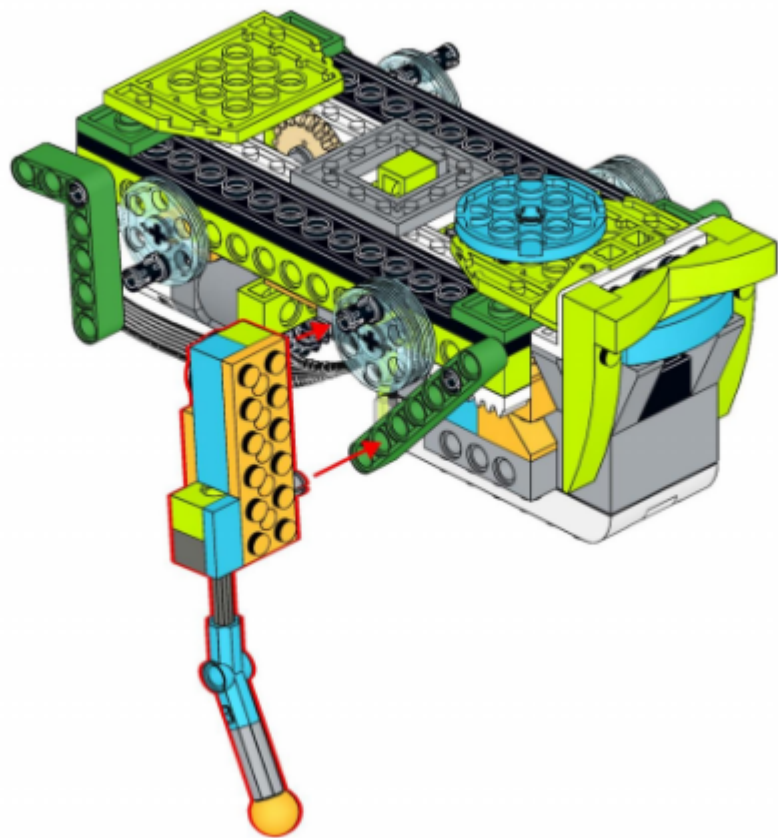

43

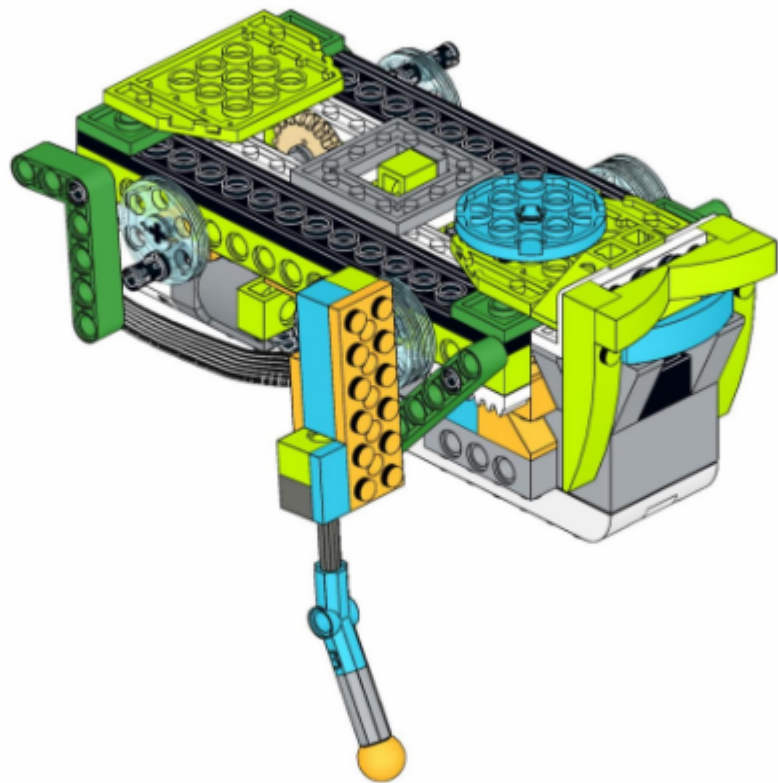

44

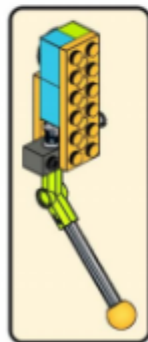
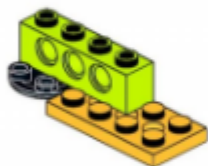
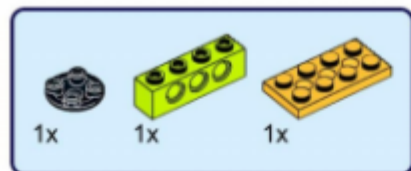

45

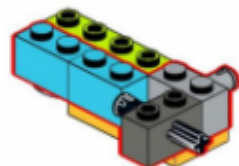
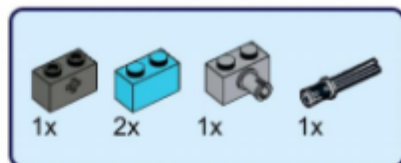

46

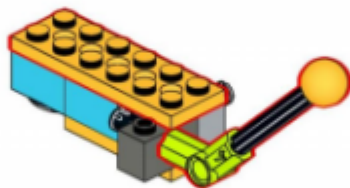

47

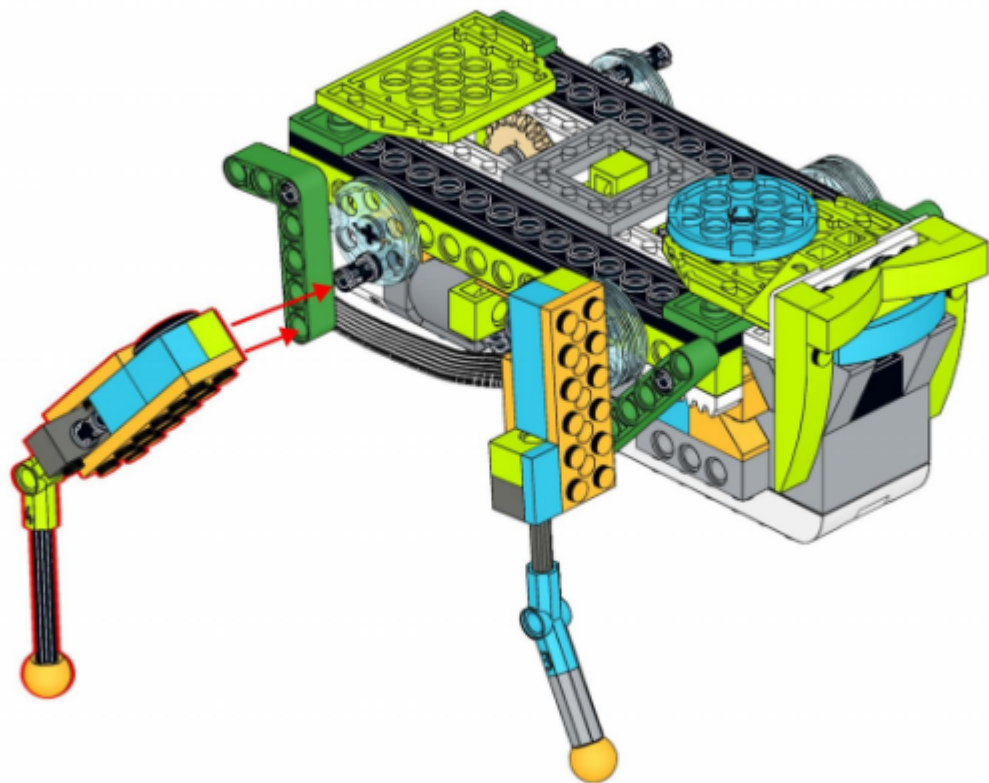

48

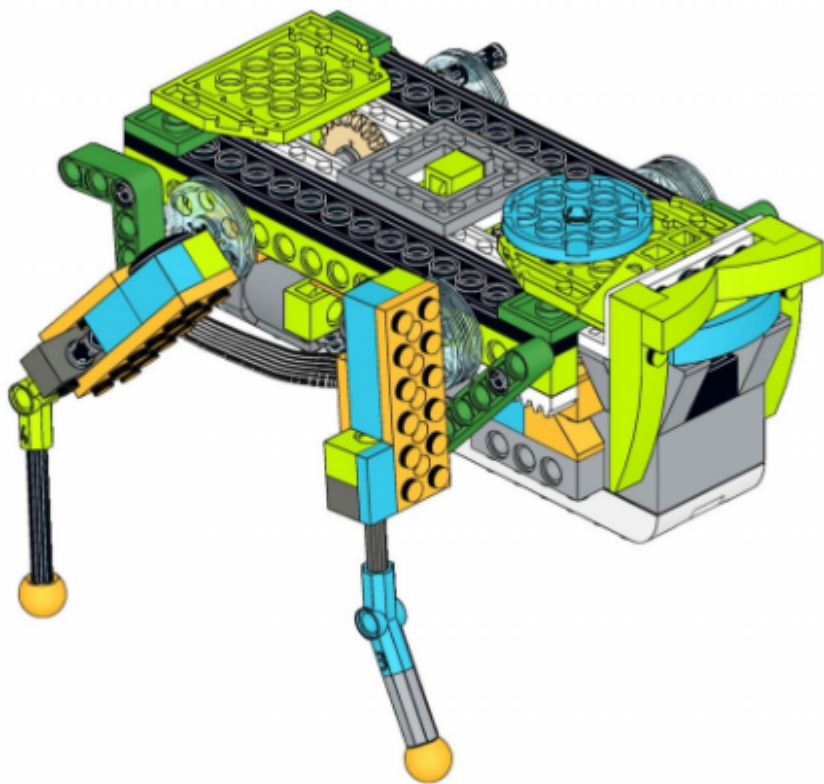

49

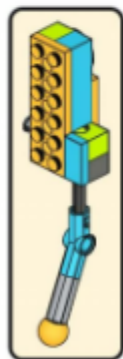
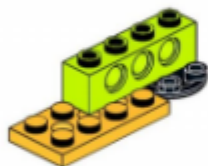
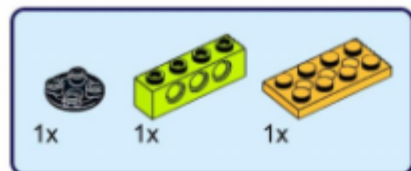

50

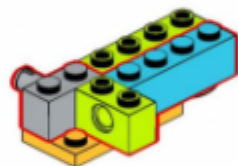
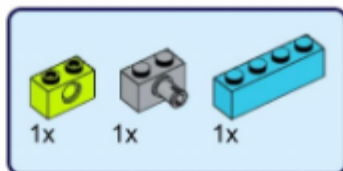

51

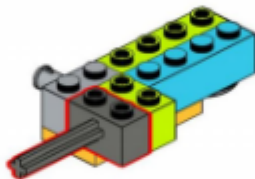
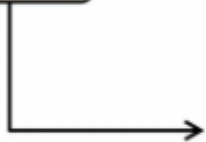
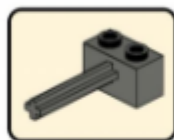
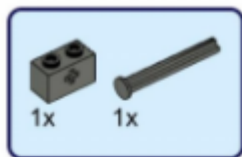

52

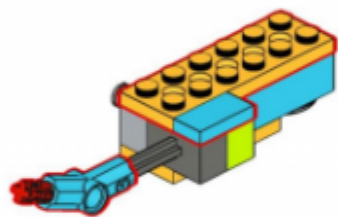

53

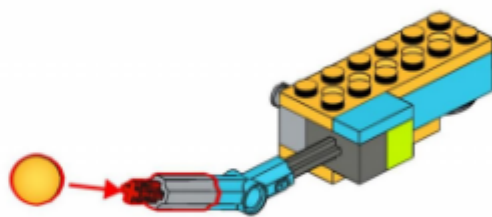

54

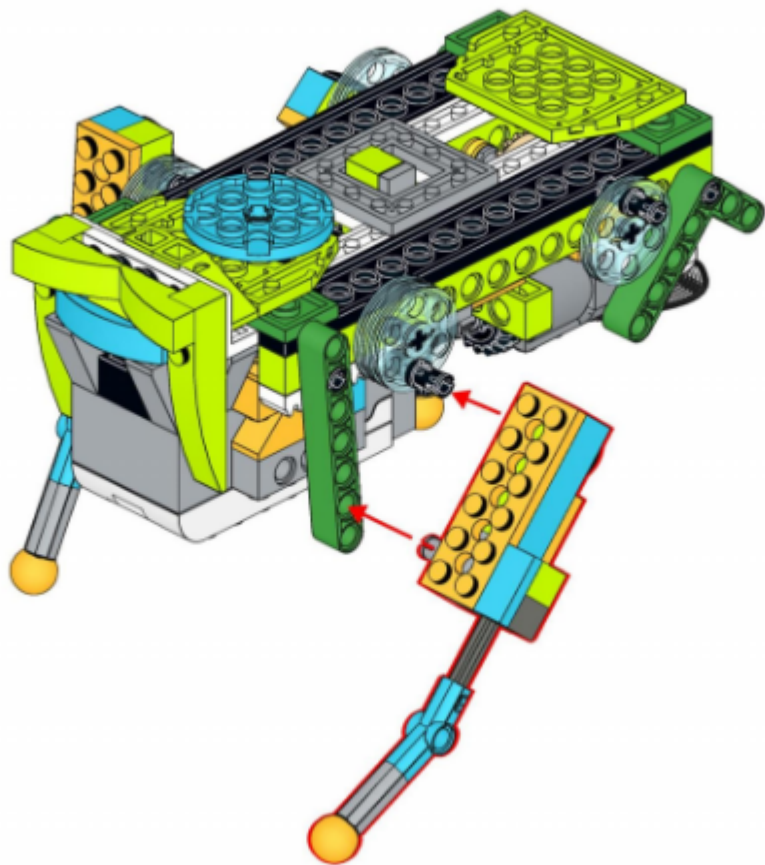

55

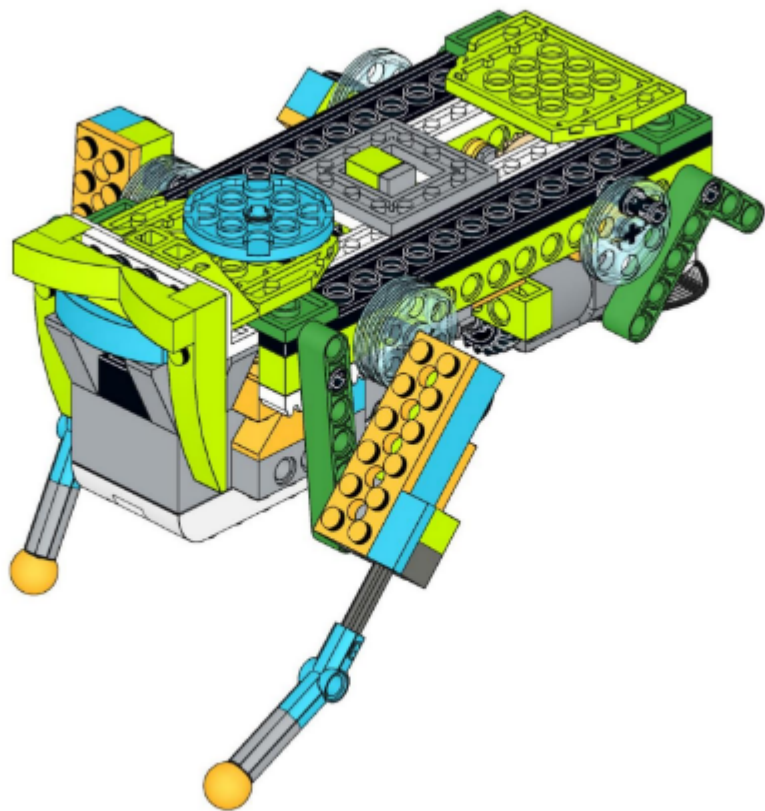

56

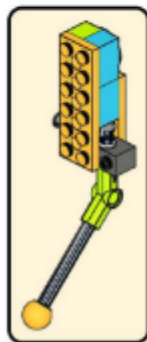
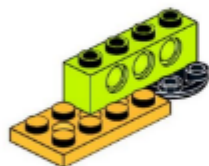
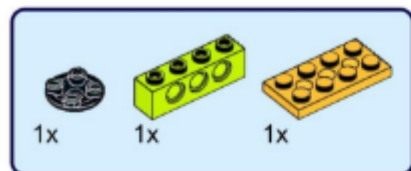

57

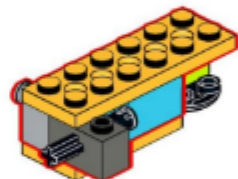
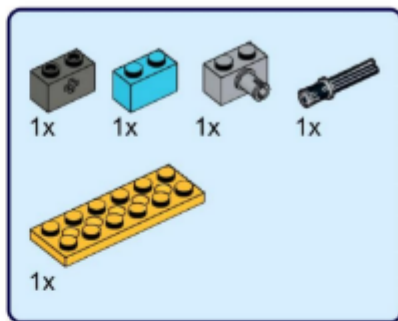

58

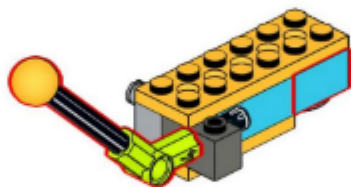
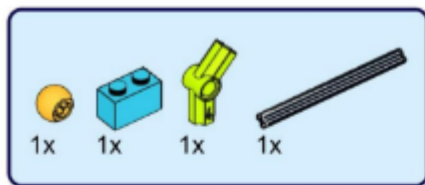

59

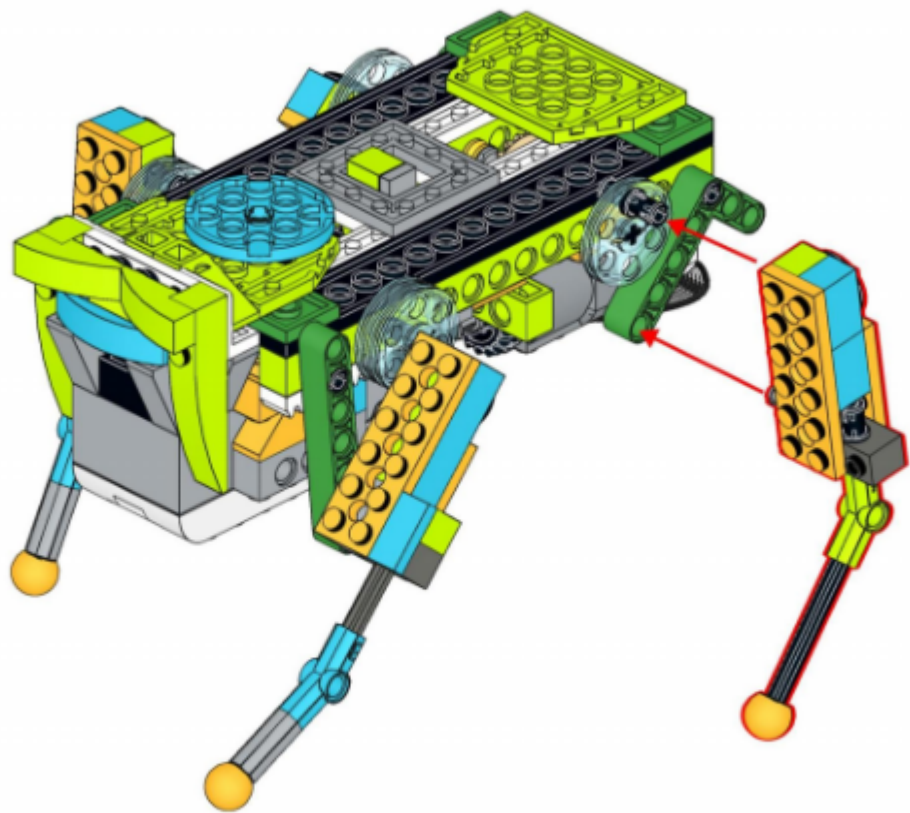

60

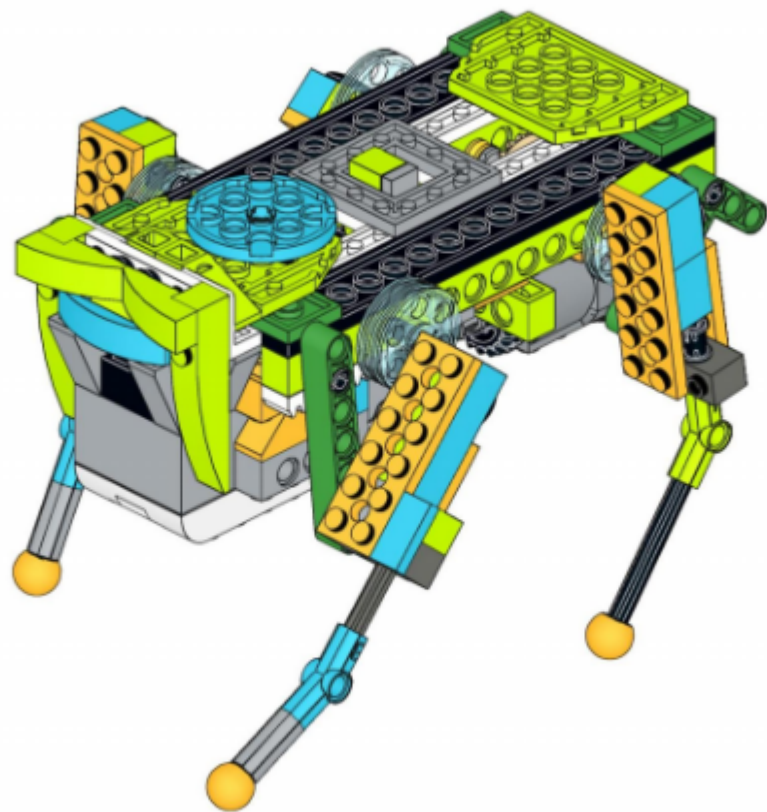

61

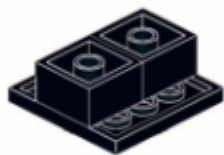
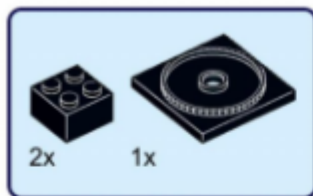

62

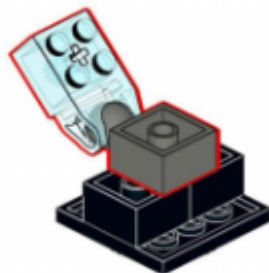
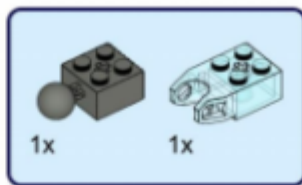

63

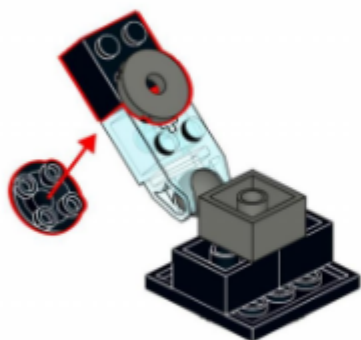
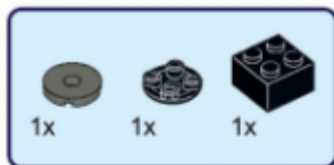

64

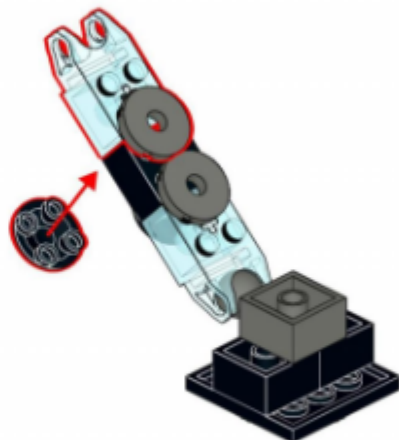

65

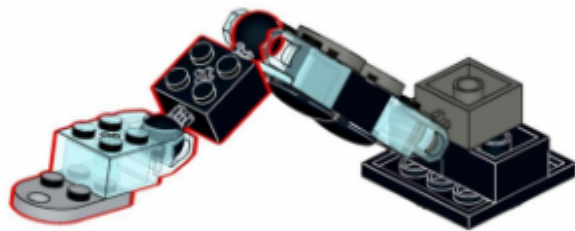
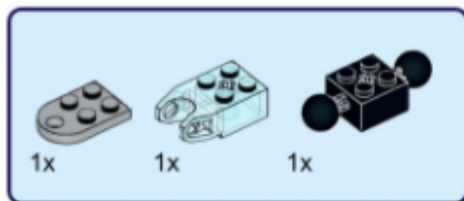

66

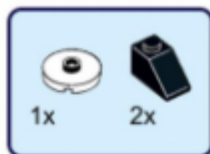

67

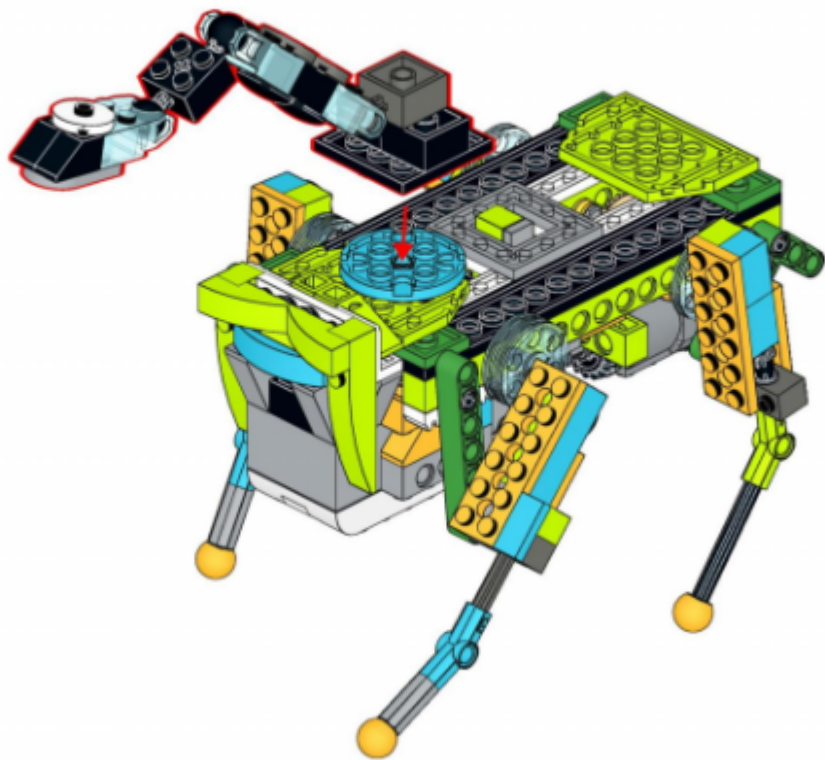

68

