

1

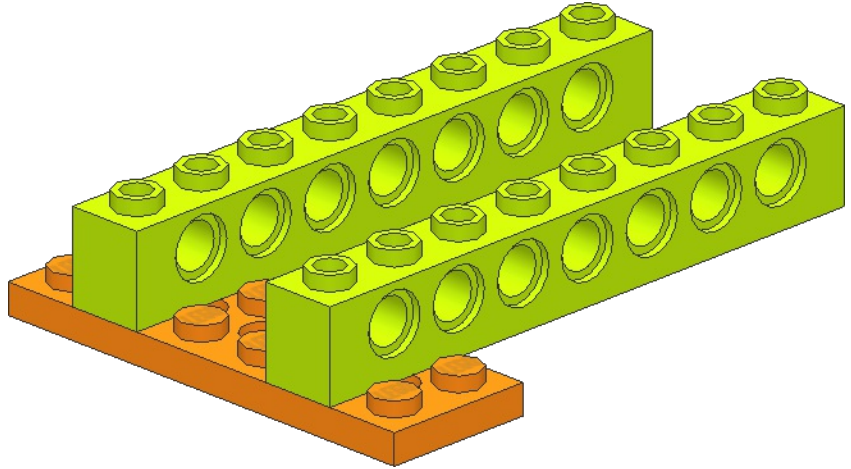

2

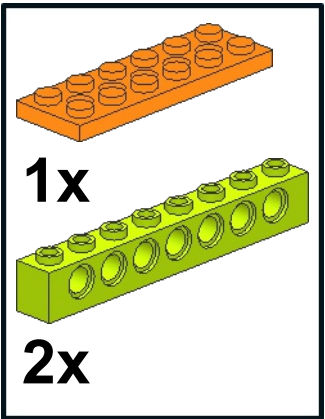
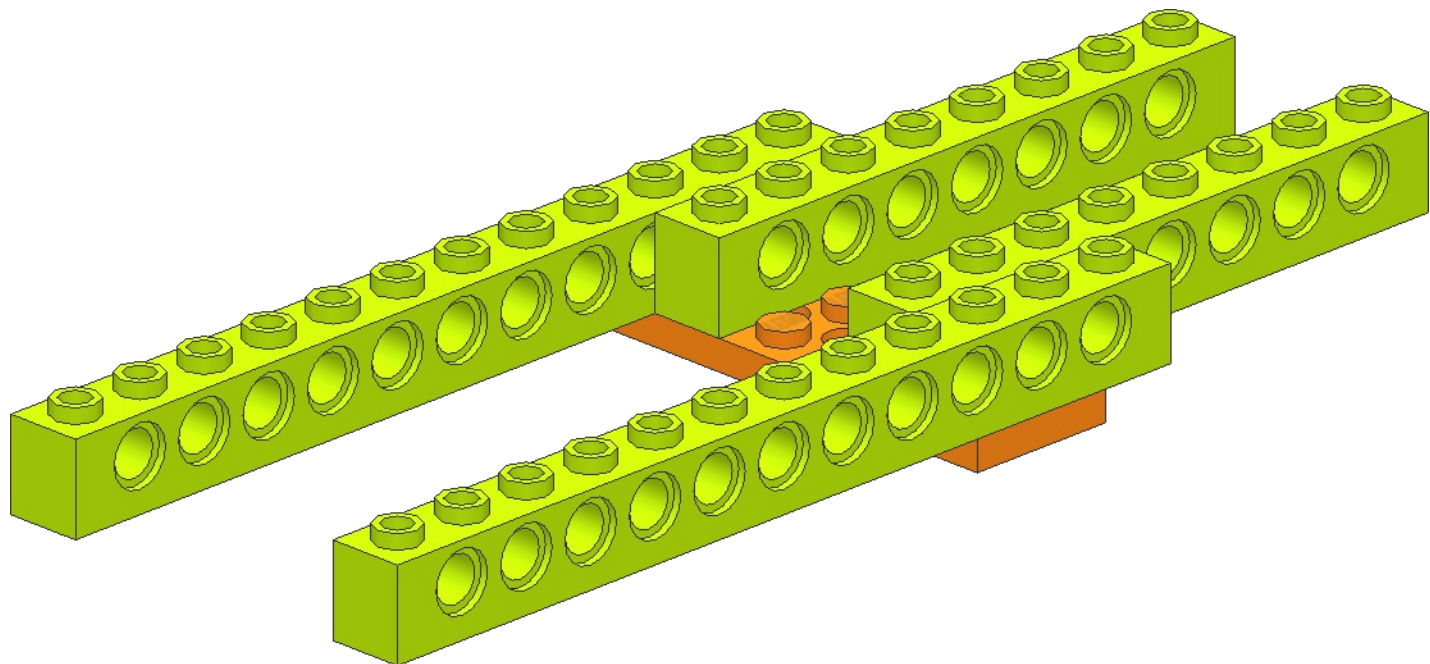
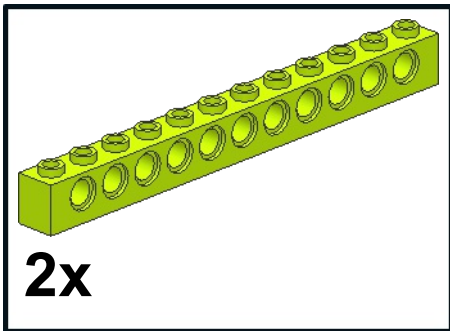

3

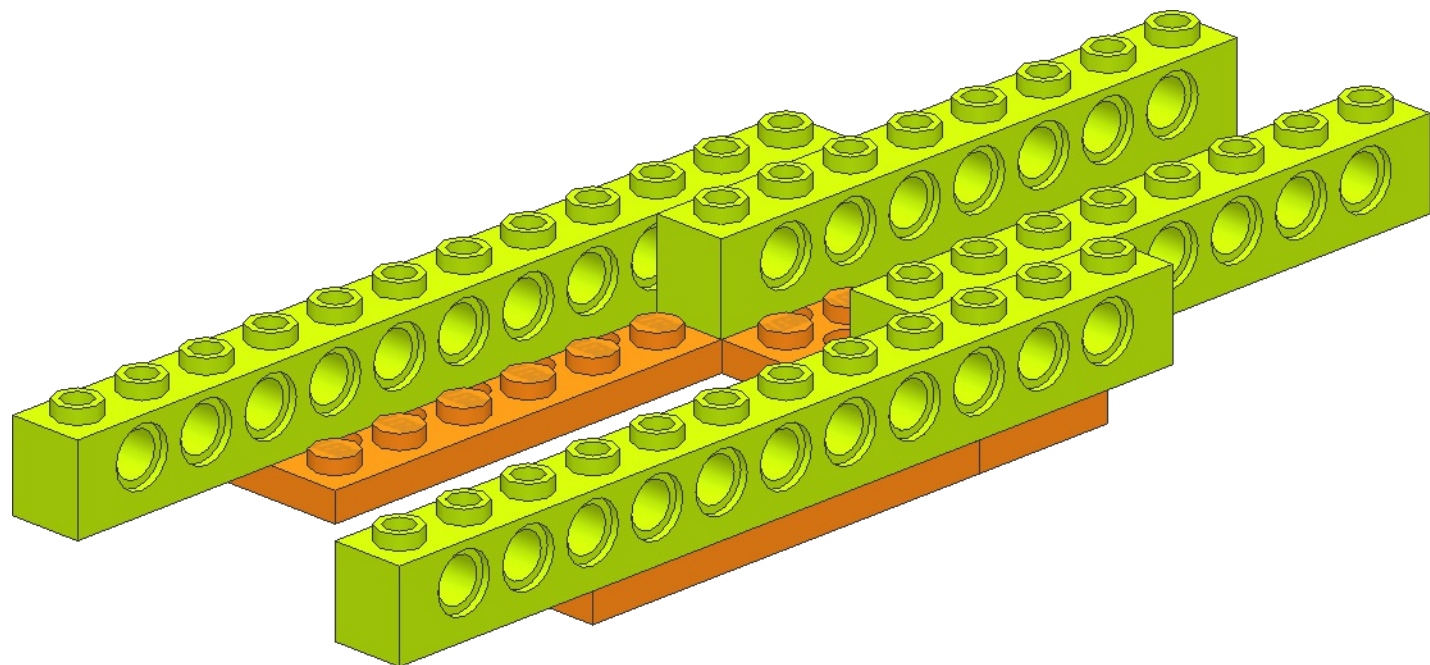
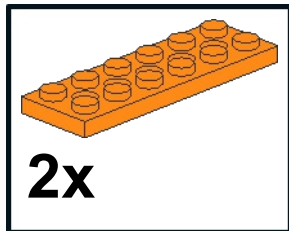

4

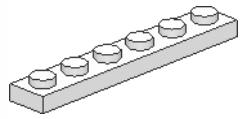

1x

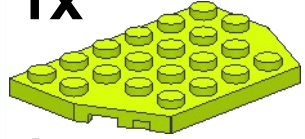

1x

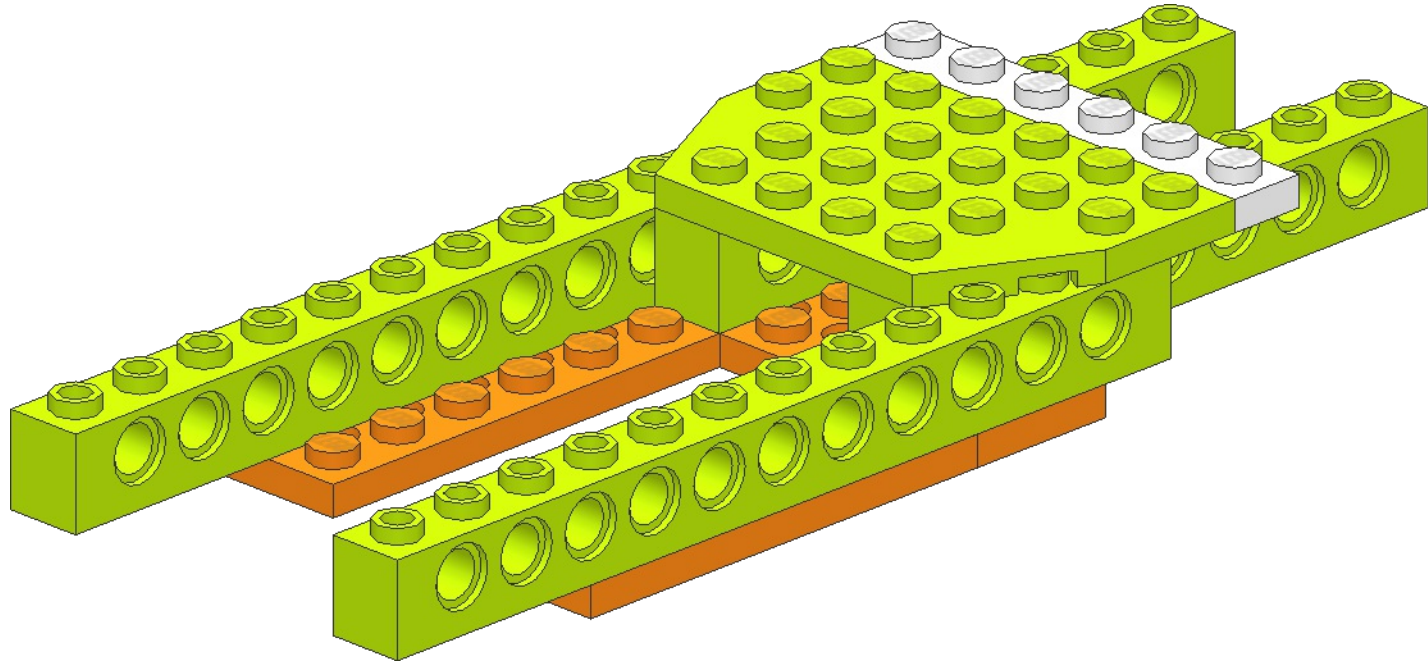

5

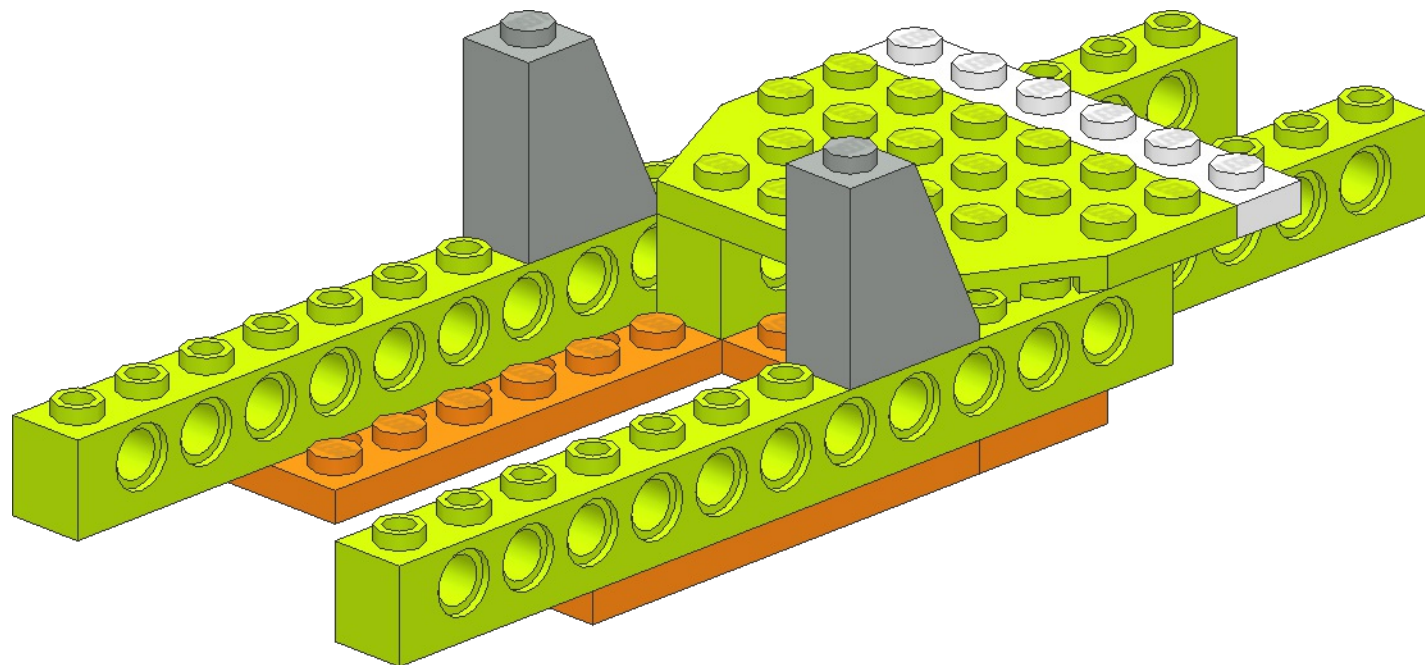
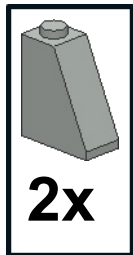

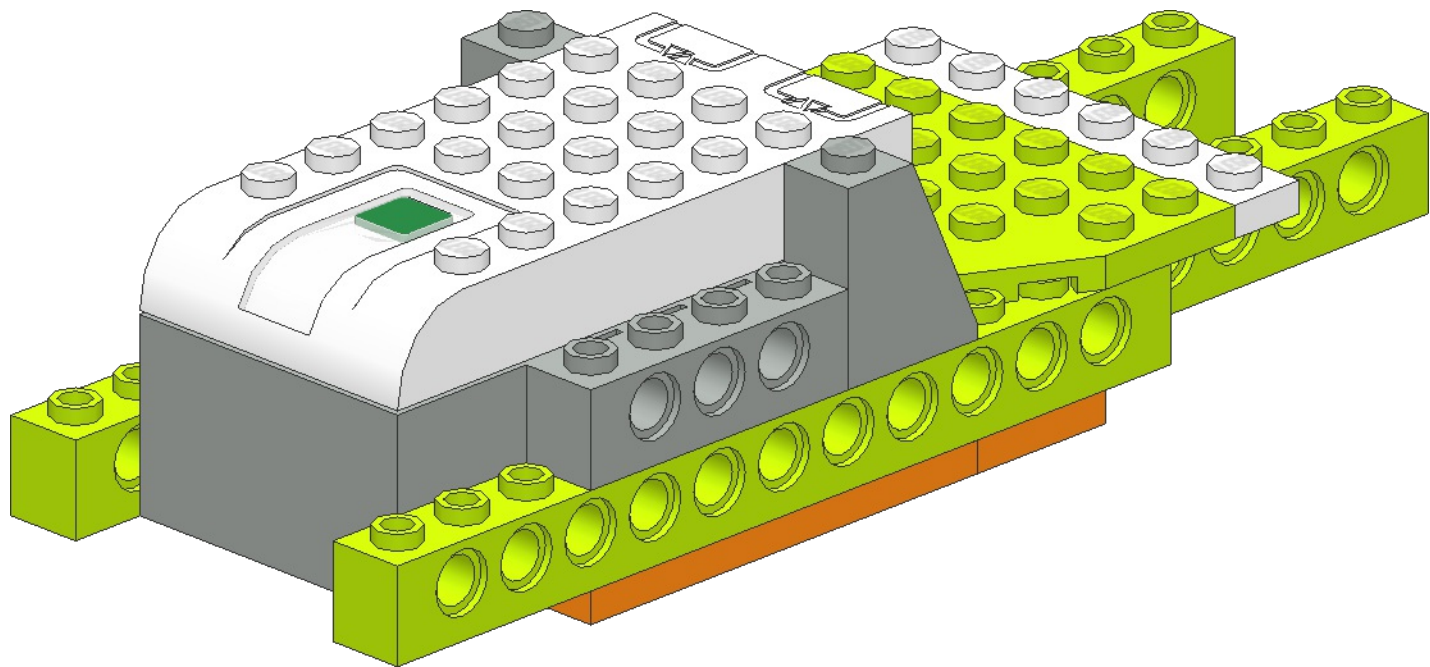

7

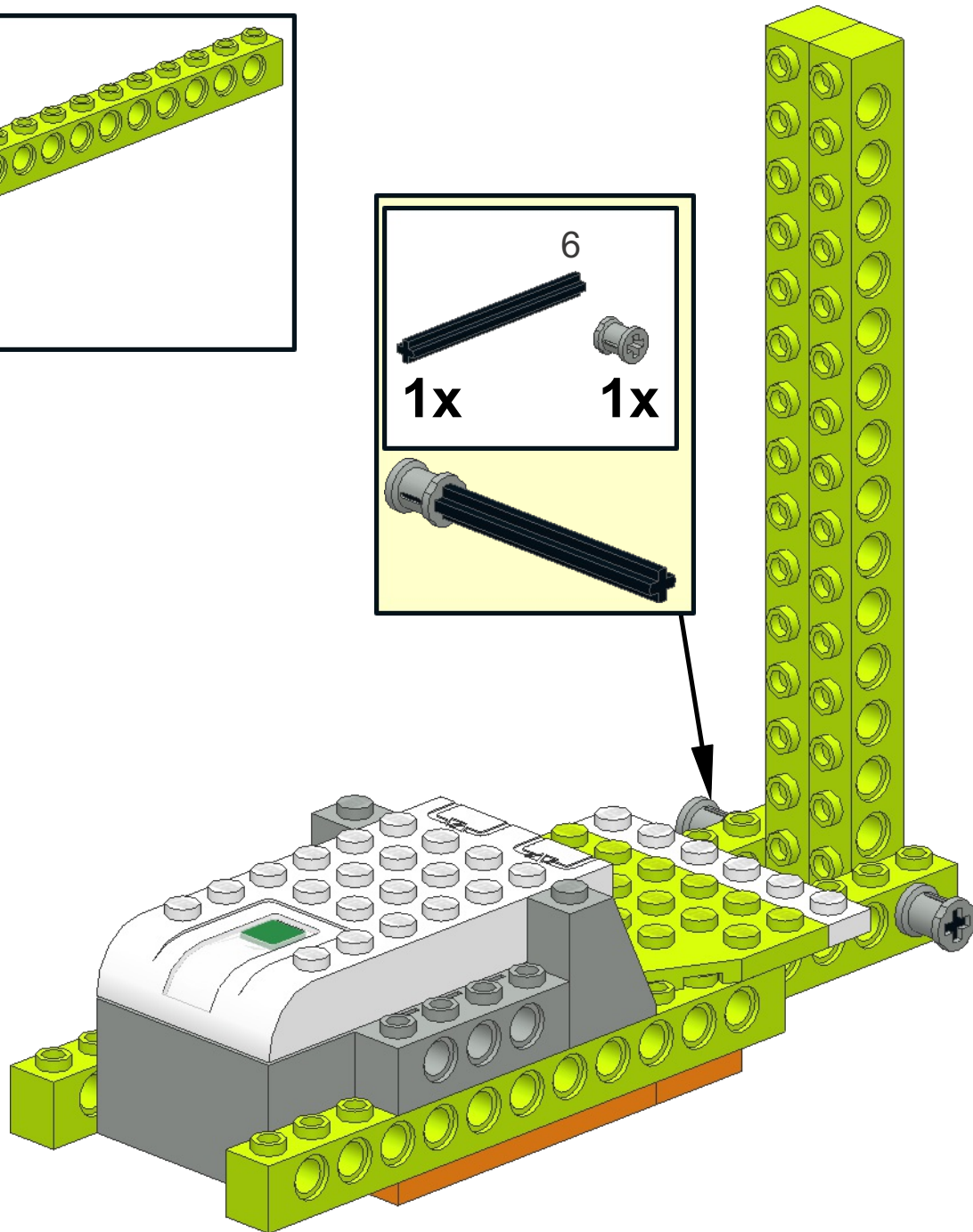
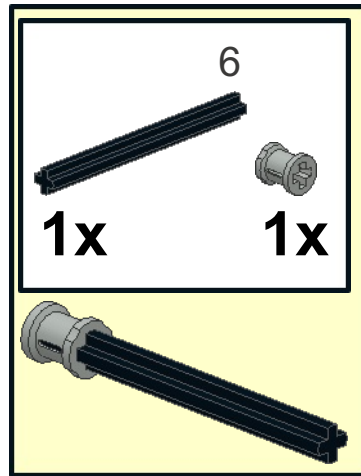
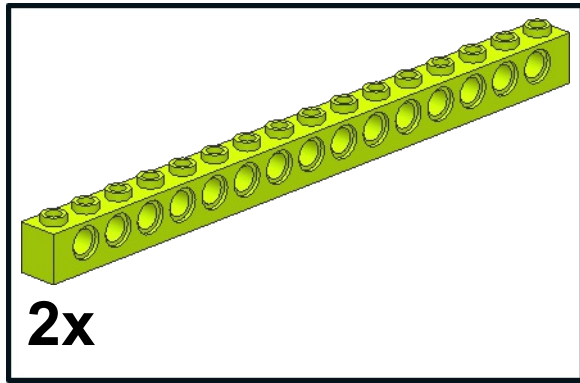

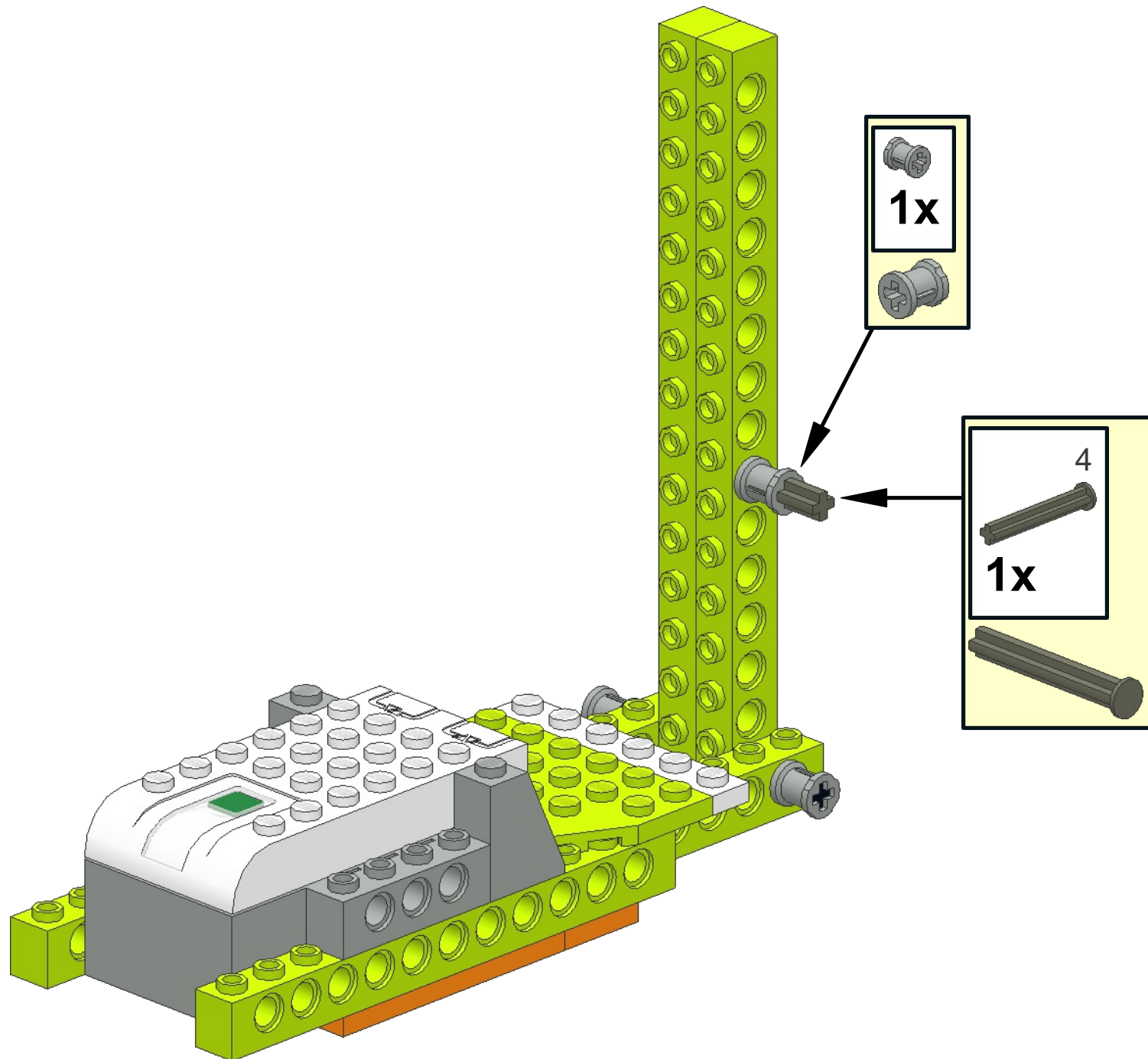

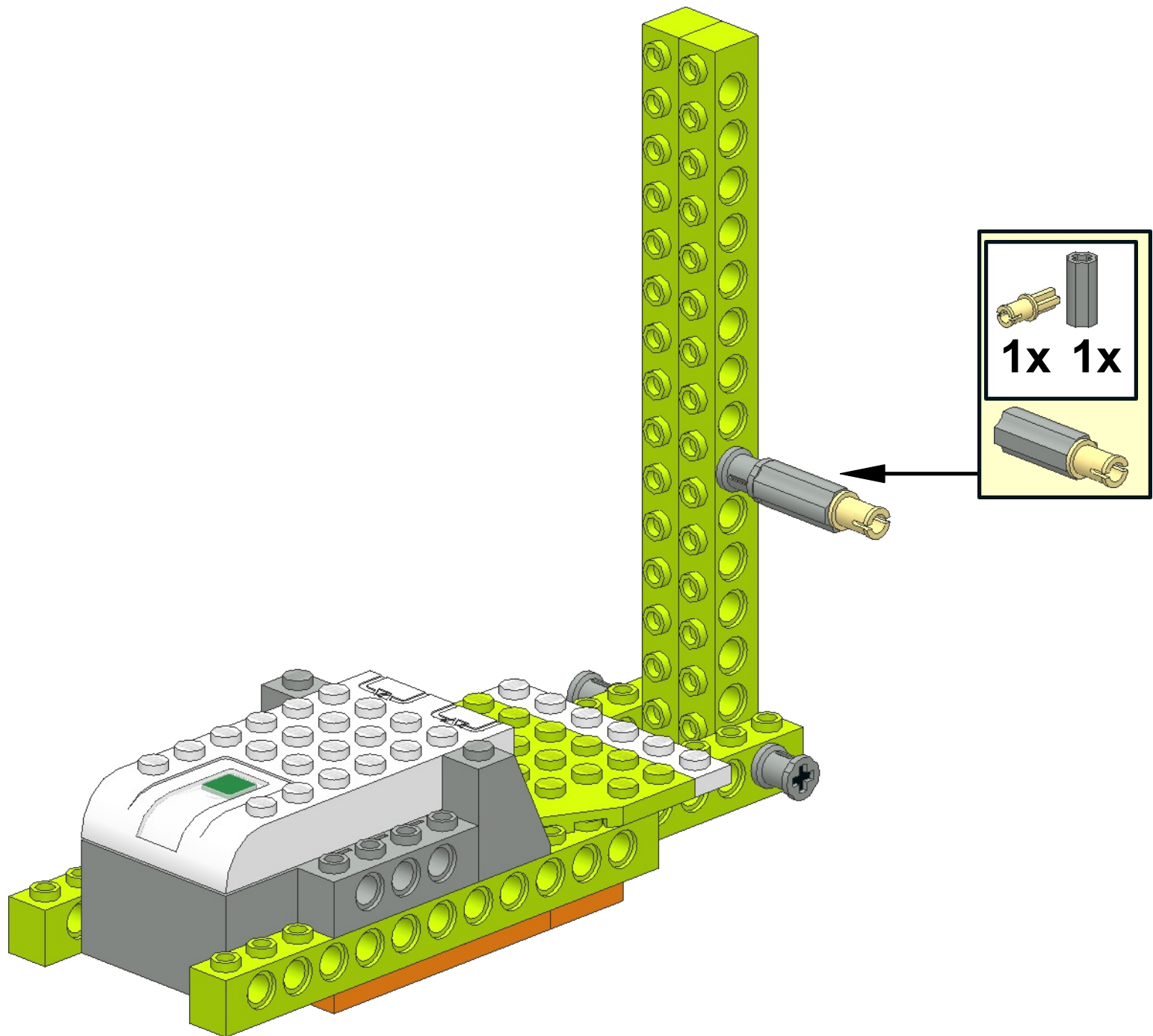

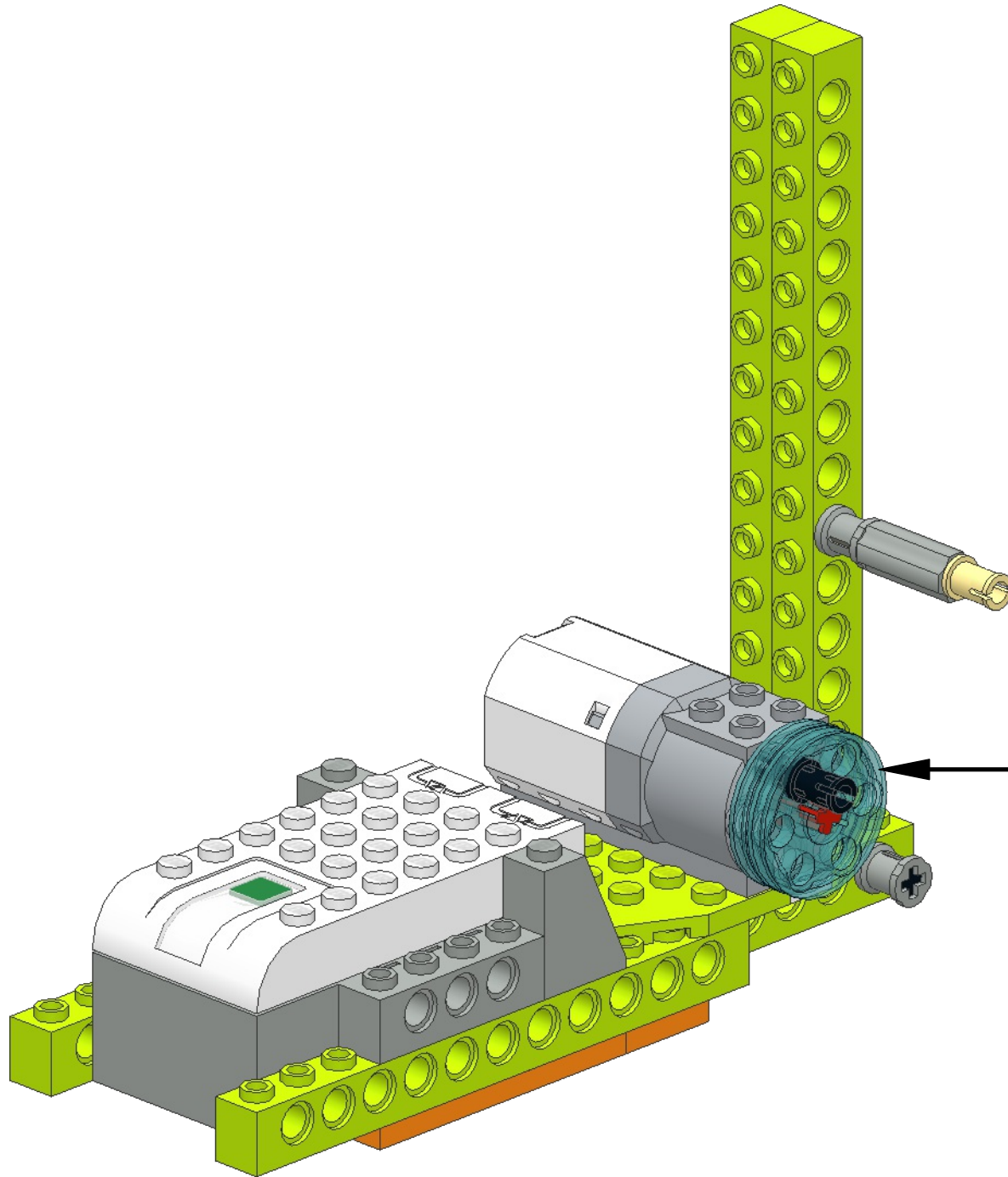

1

1x 1x

2

2x 1x

The inset diagrams show the assembly steps. Inset 1 shows a grey motor with a red axle inserted into its front. Inset 2 shows a blue gear and a black axle. The main diagram shows the final assembly with the blue gear and black axle installed on the motor.

11

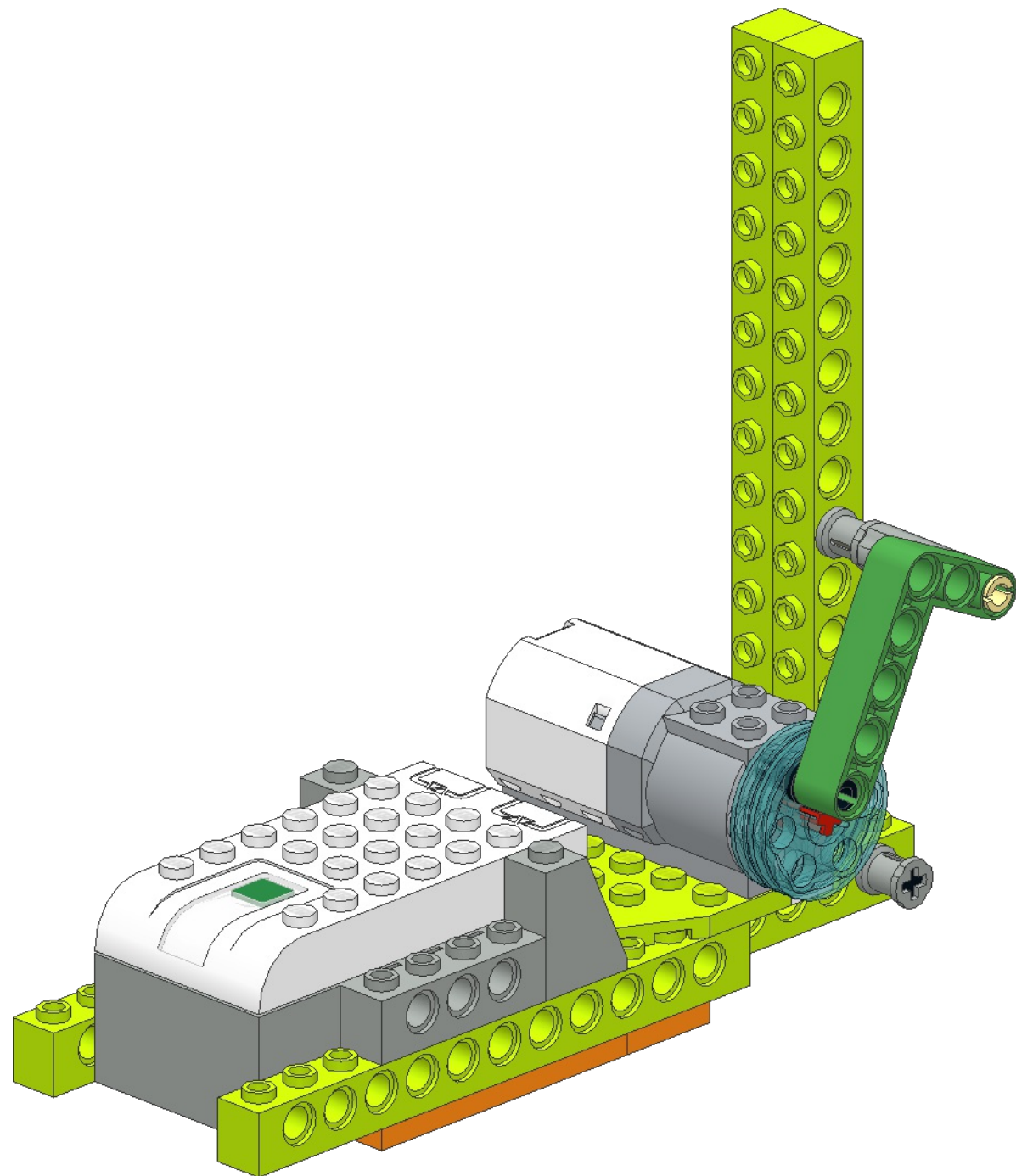
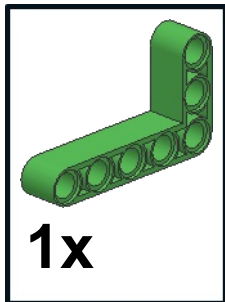

12

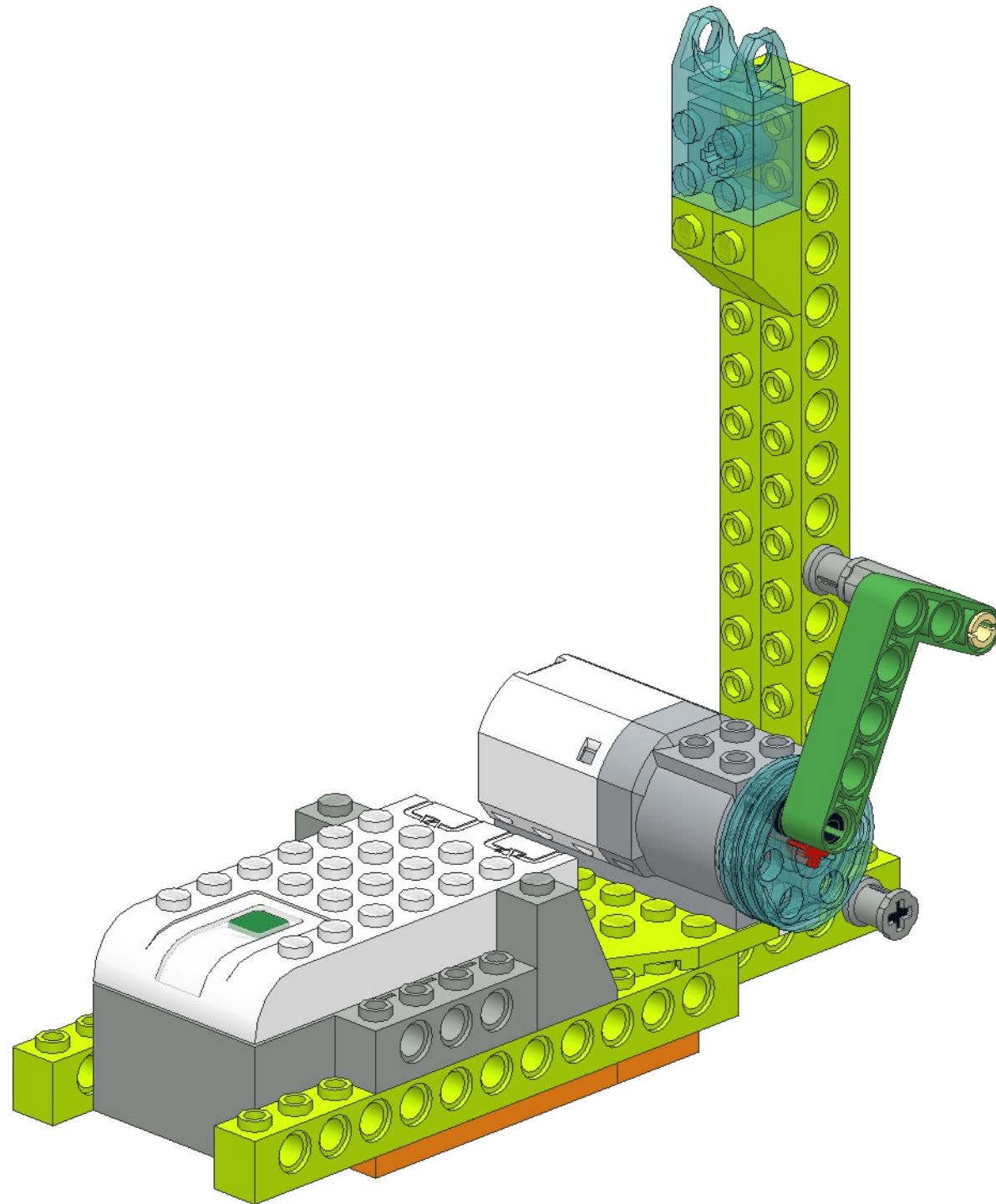
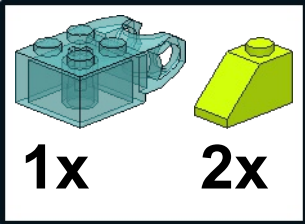

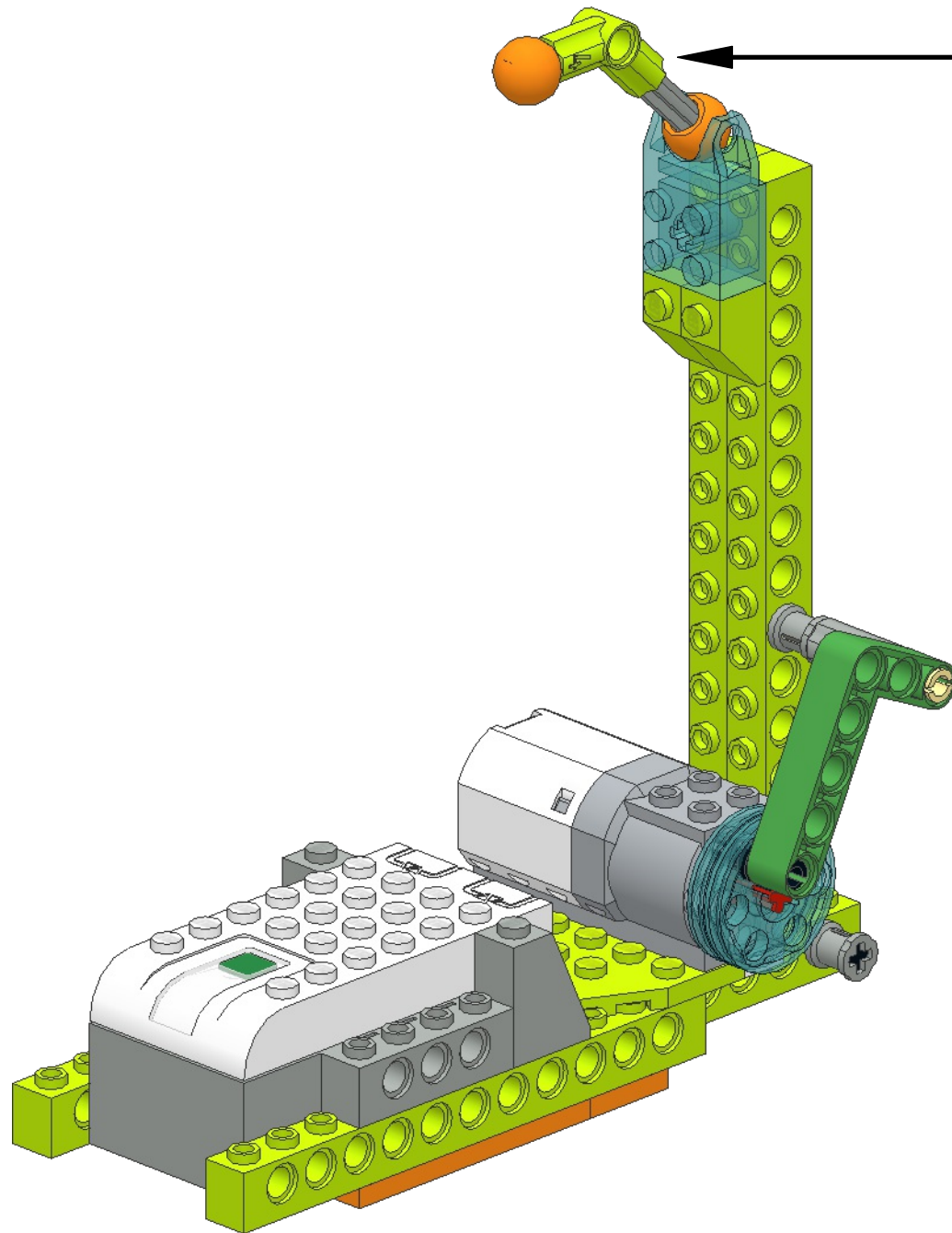

1

#4

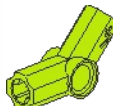

1x 3

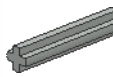

1x



2

1x

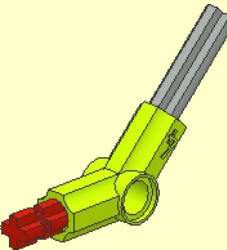

2



2x

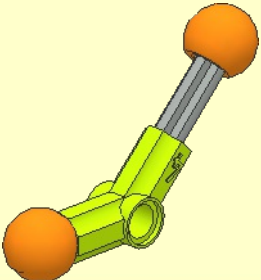

14

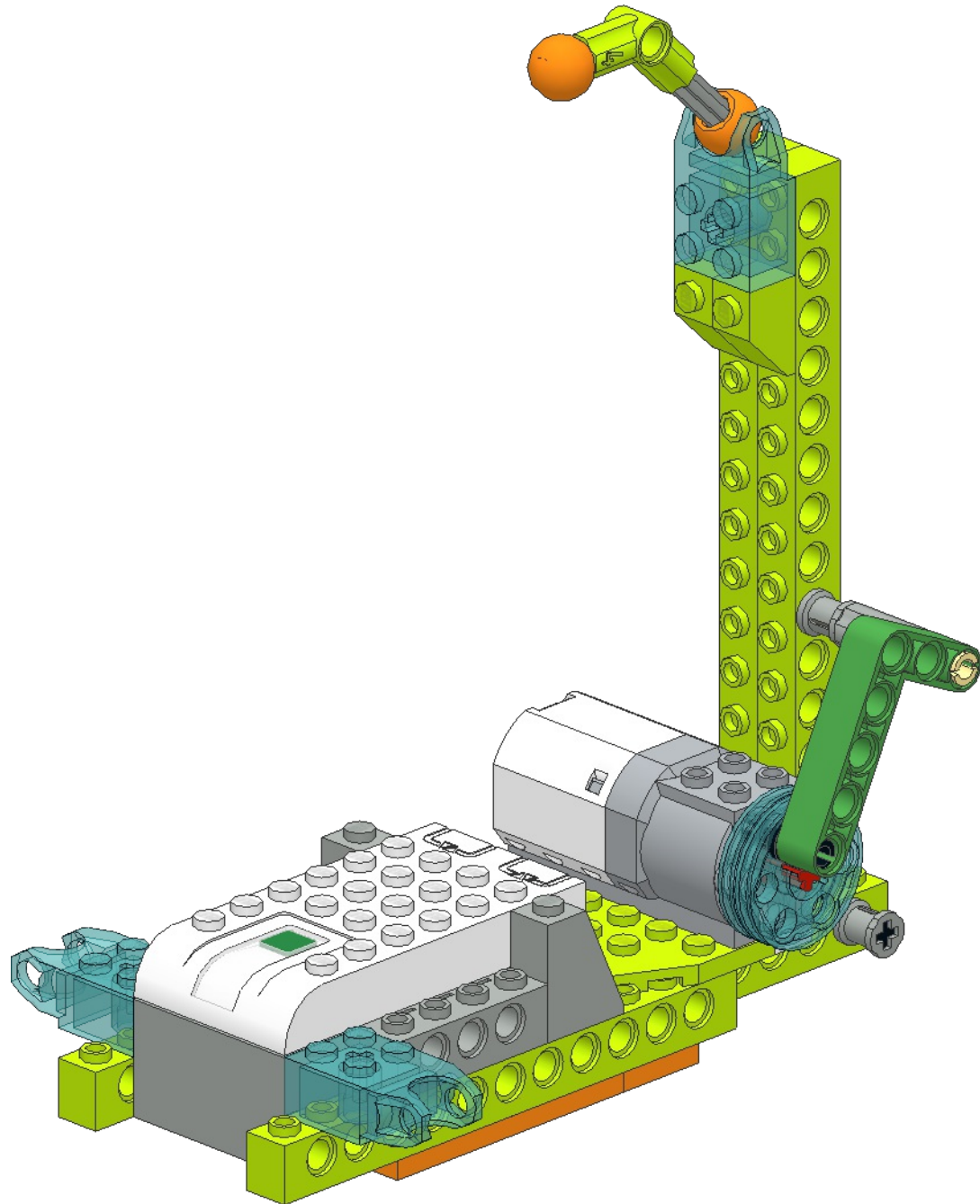

15

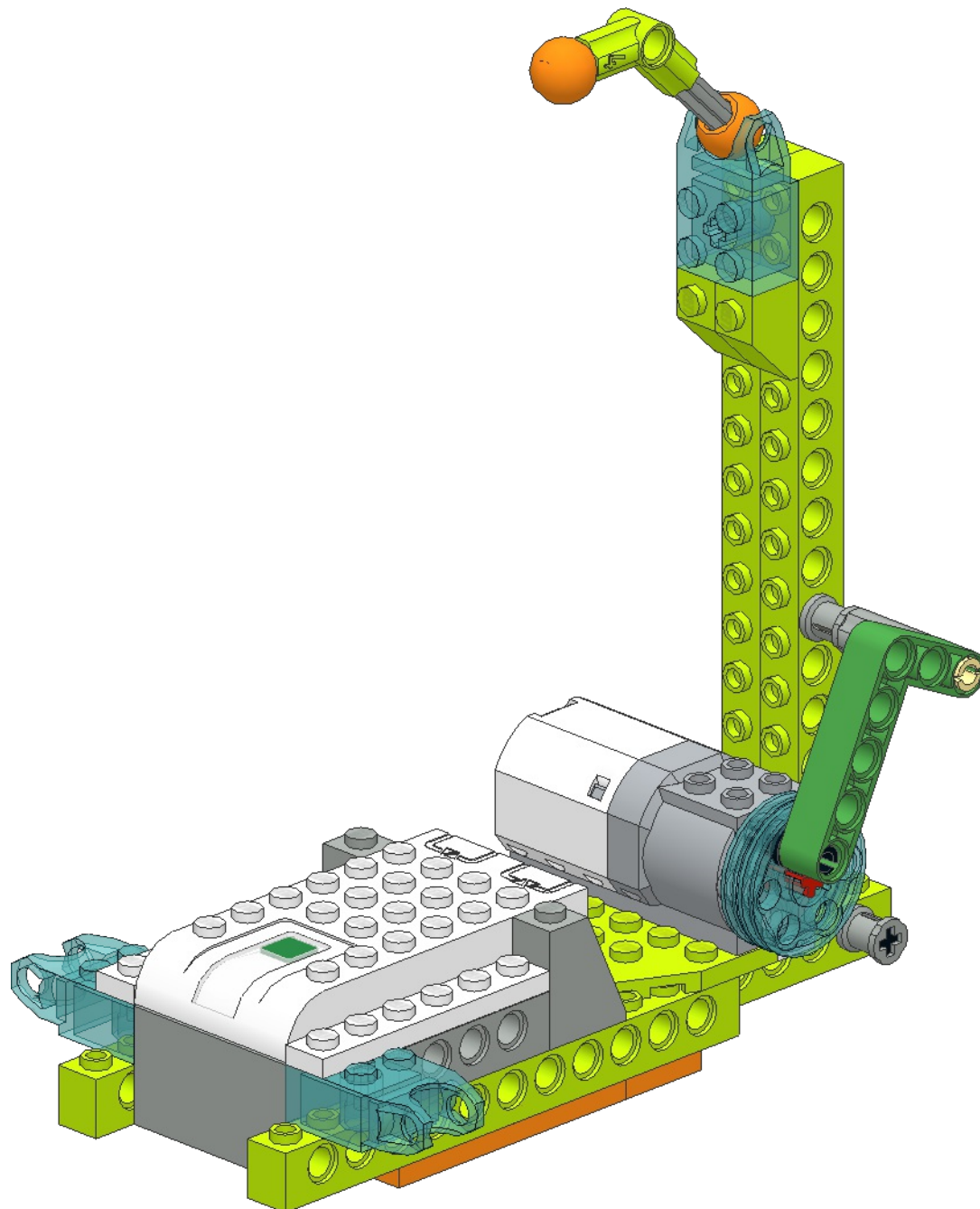
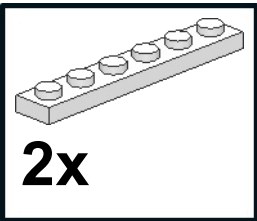

16

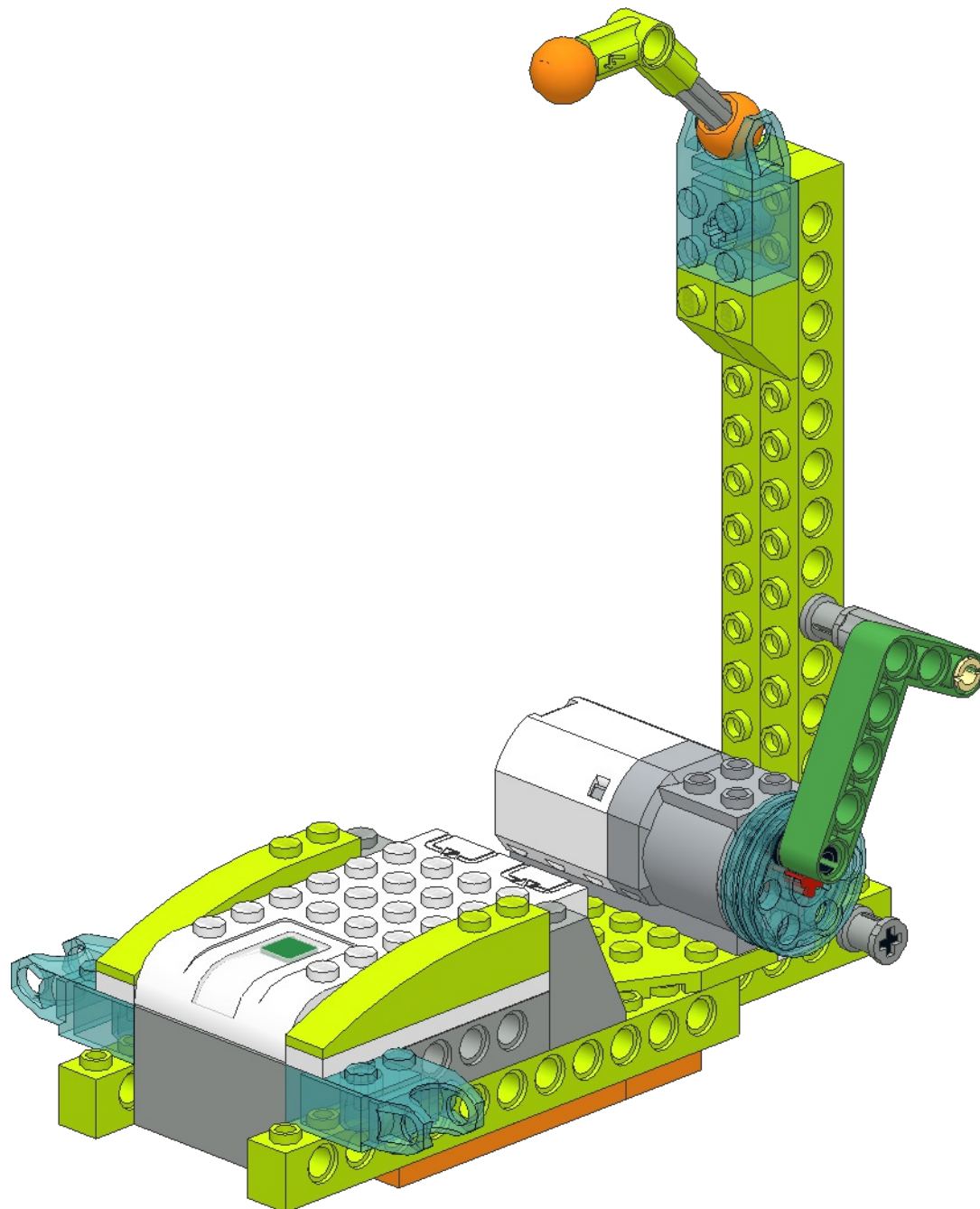
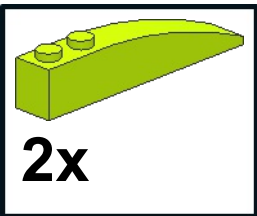

17

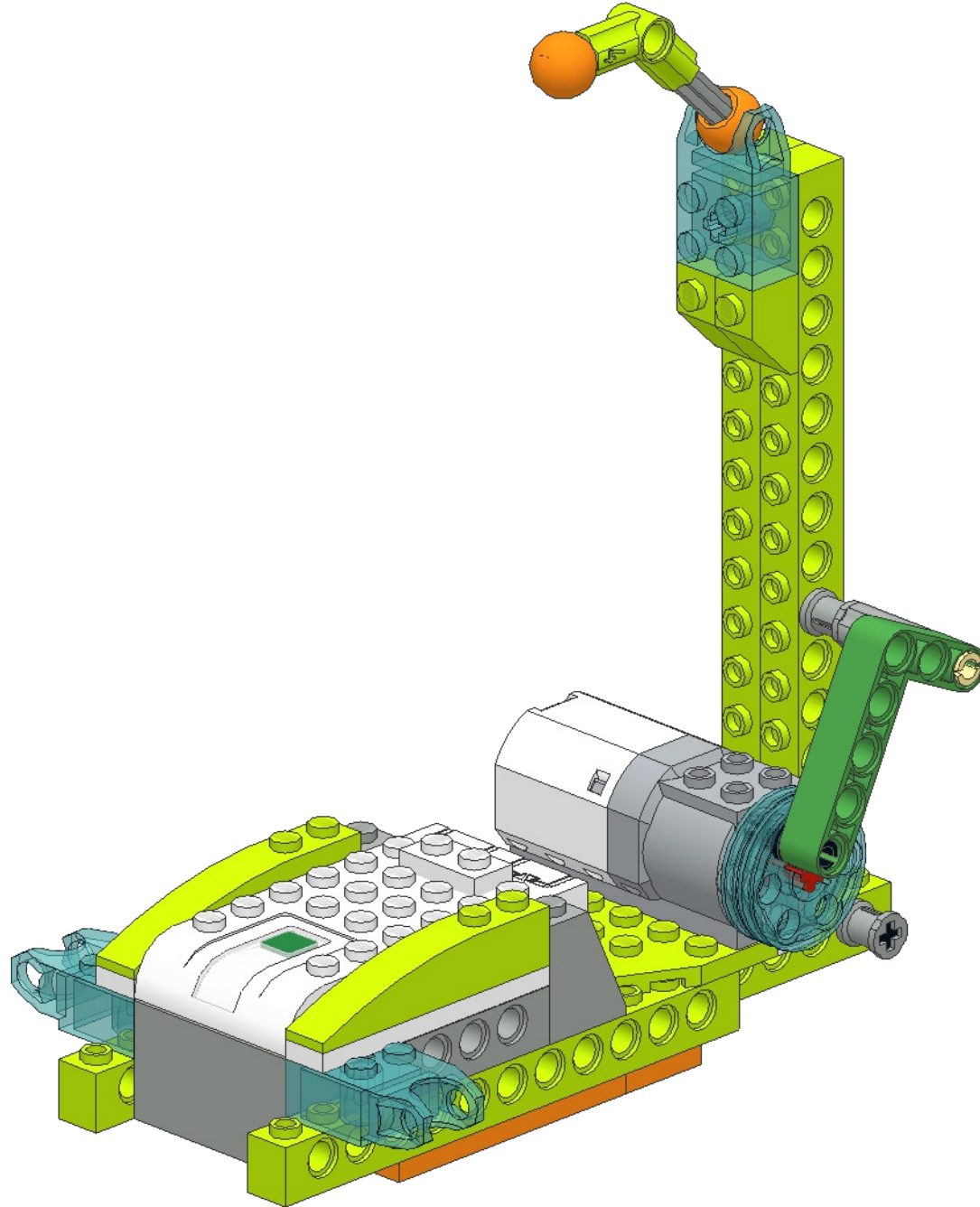
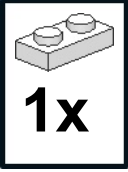

18

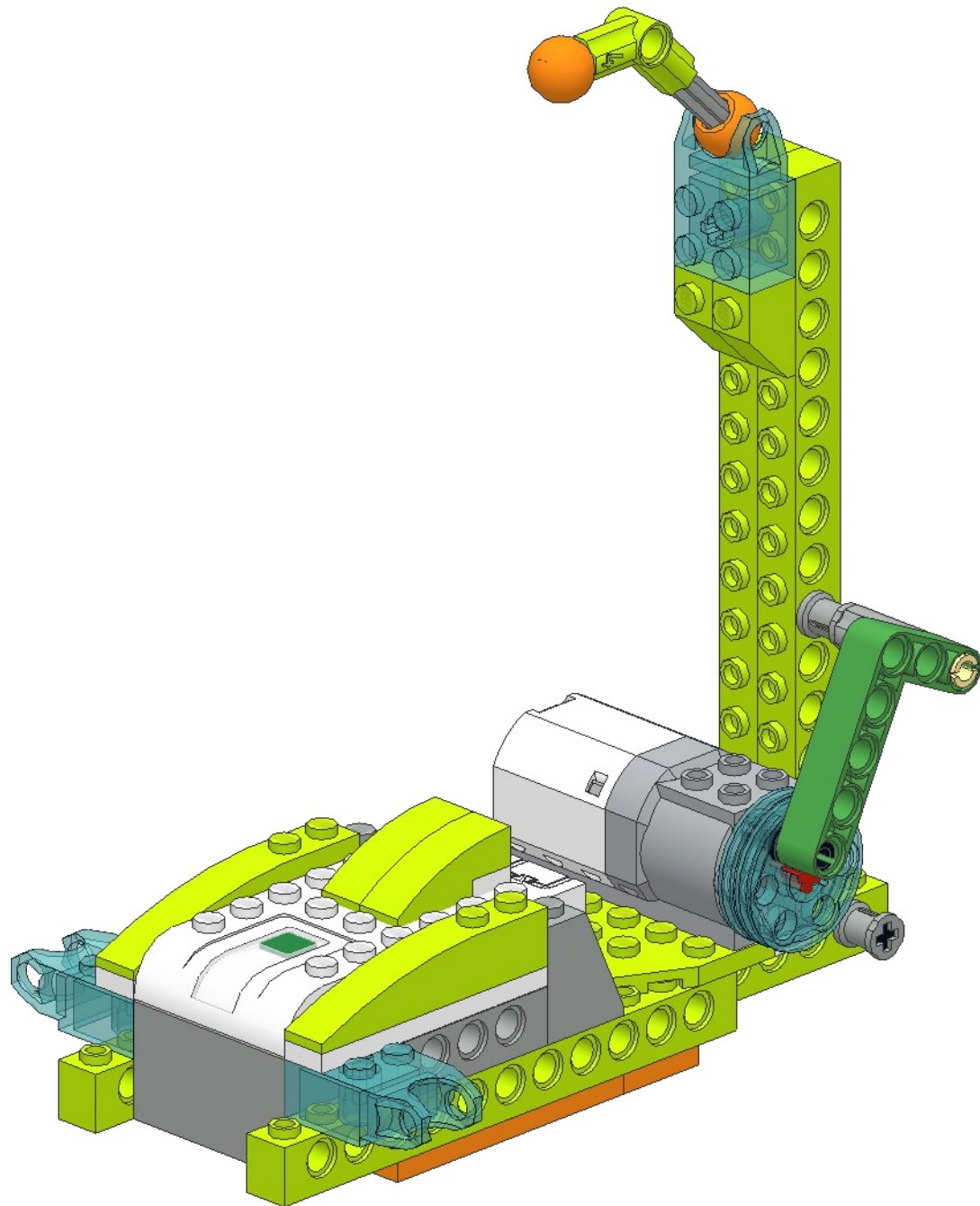
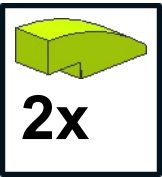

19

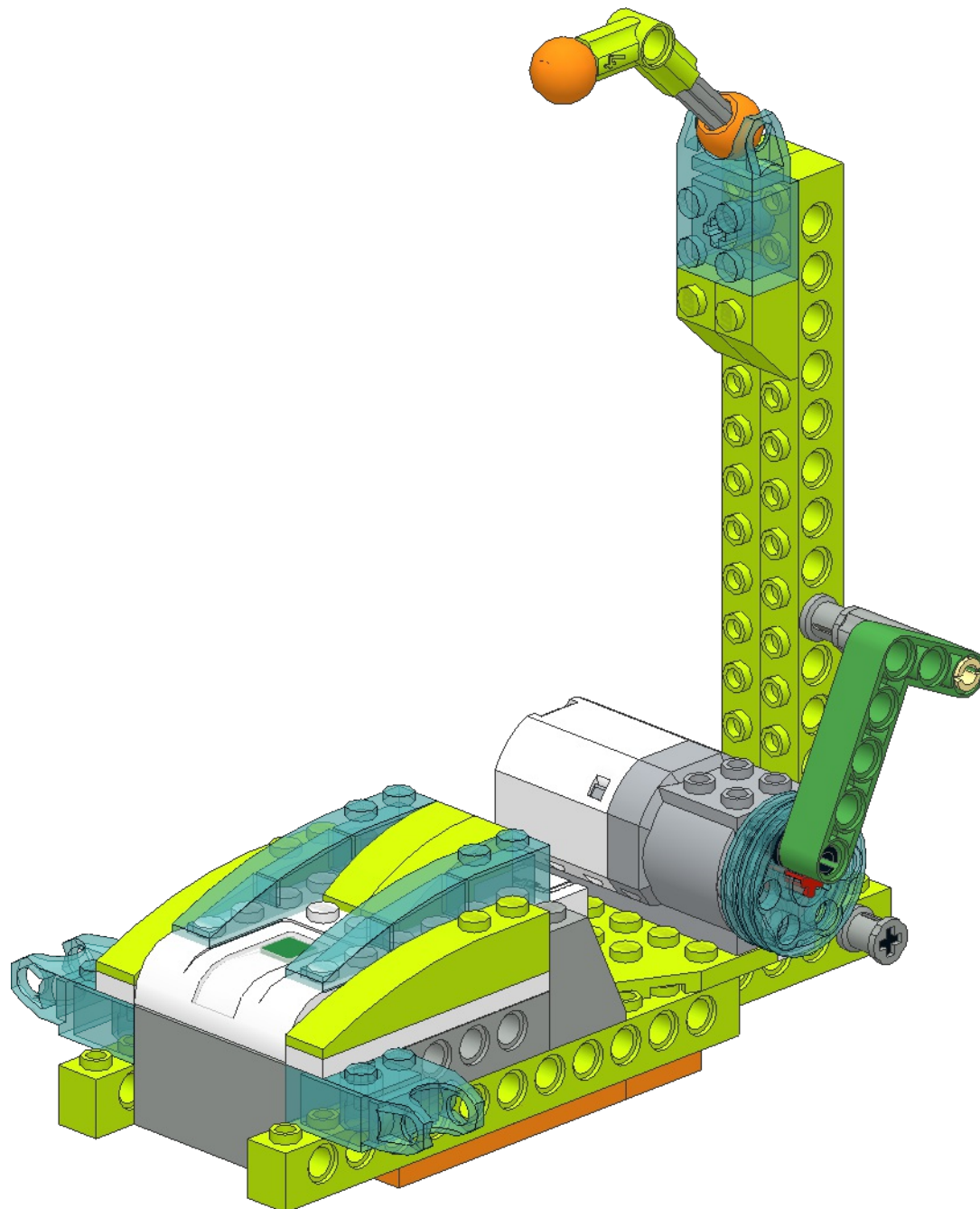
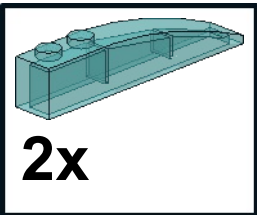

20

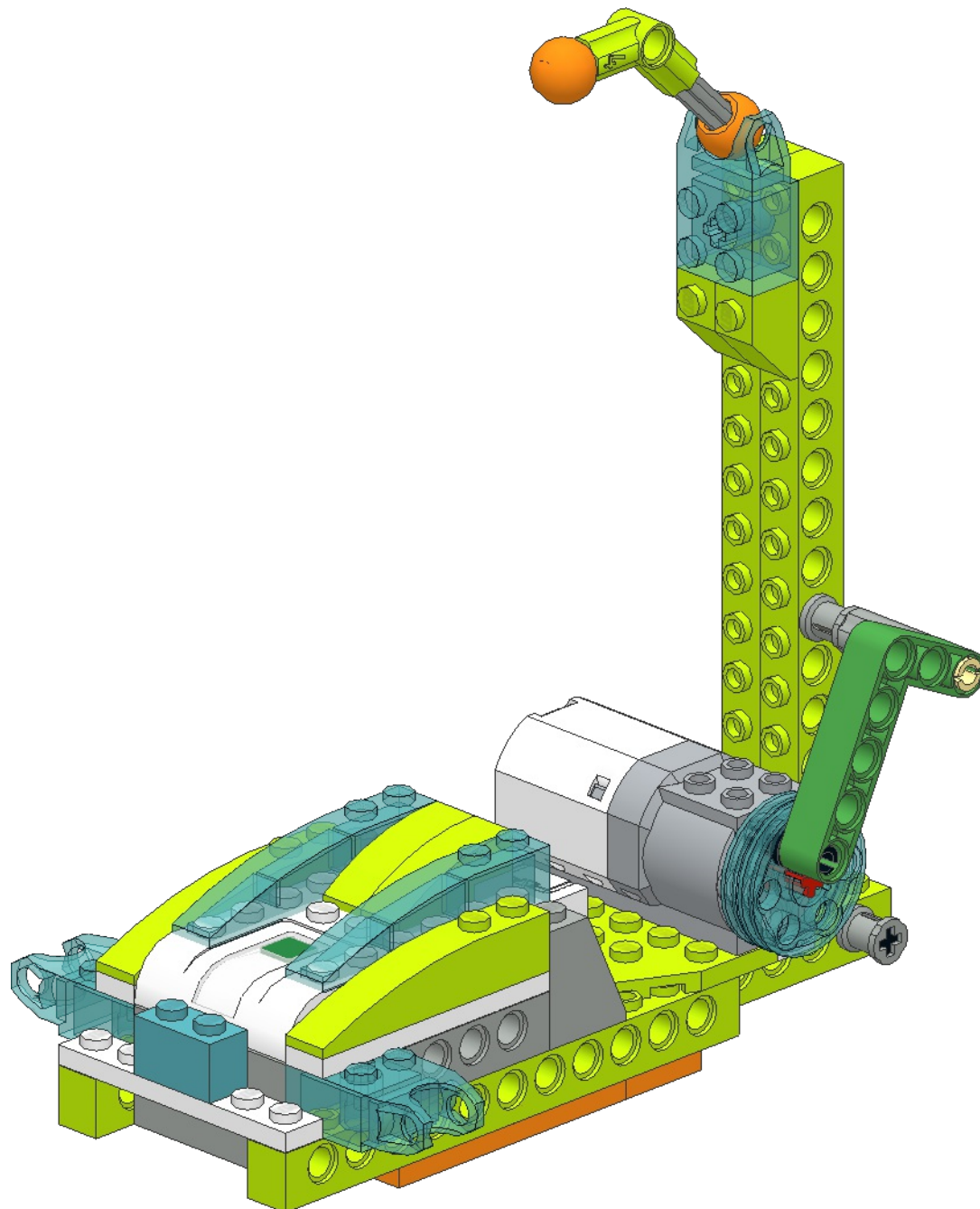
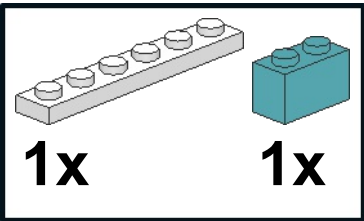

21

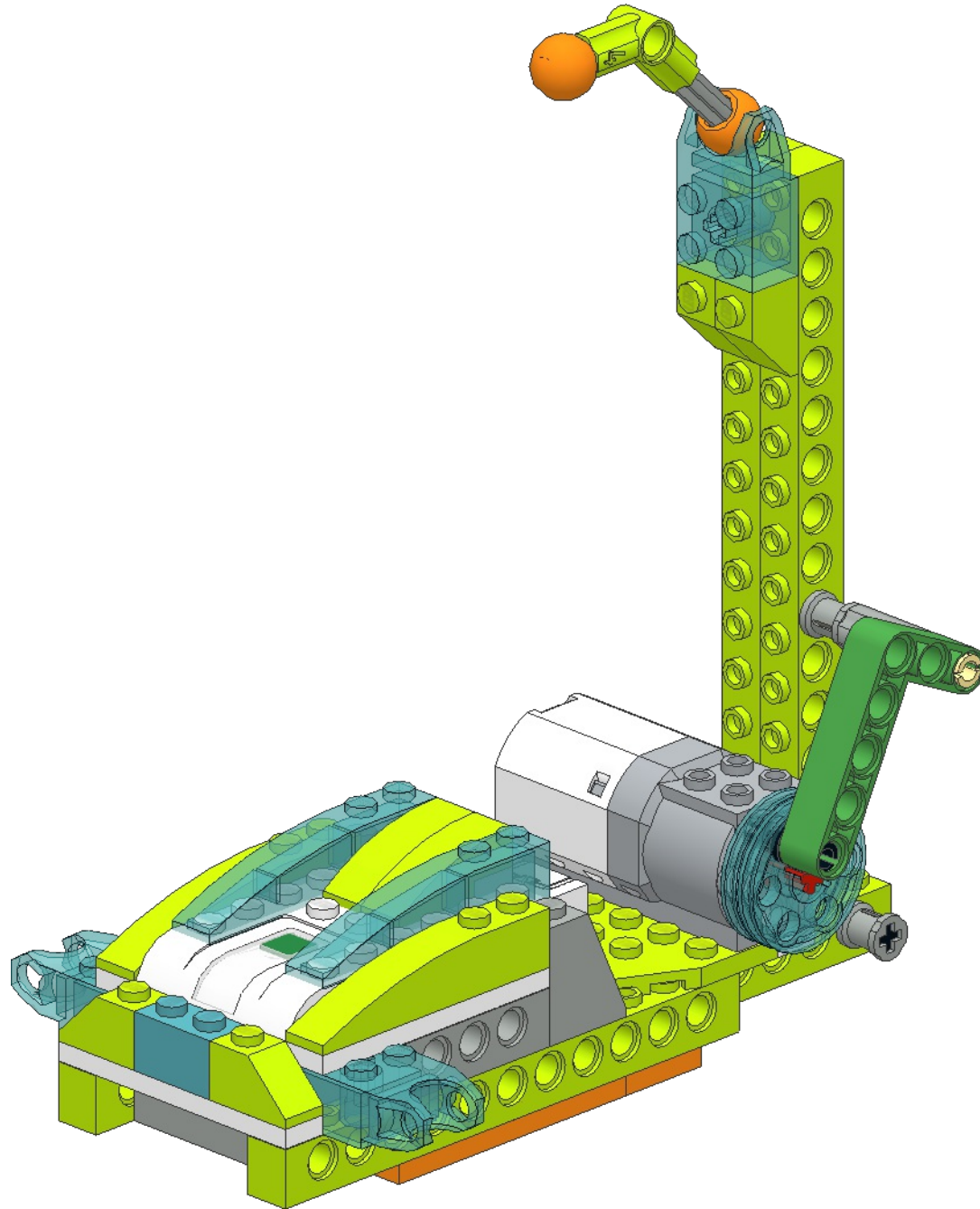
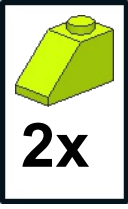

22

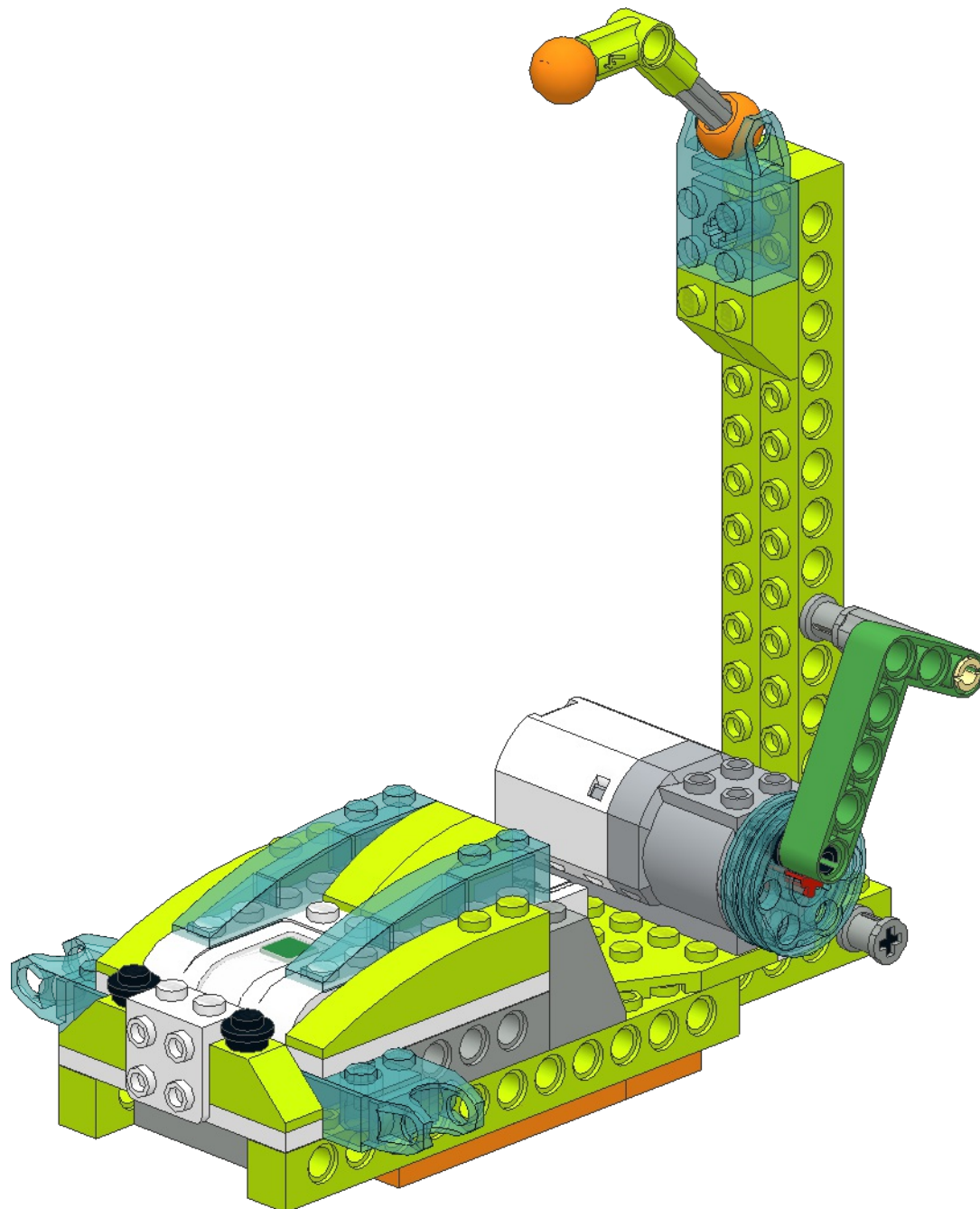
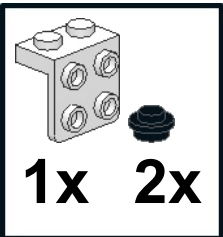

23

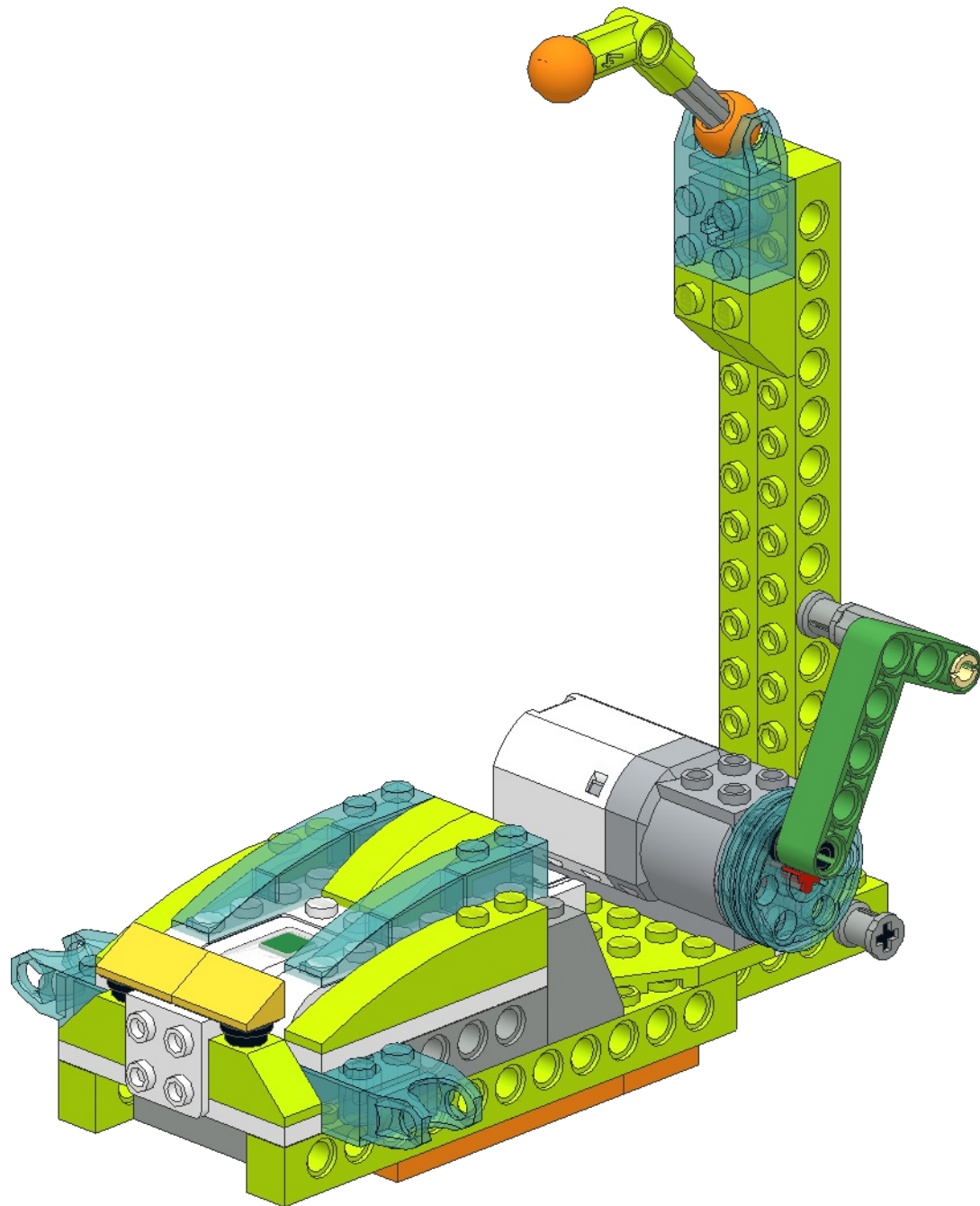

1

2x

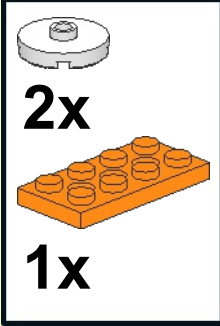

1x

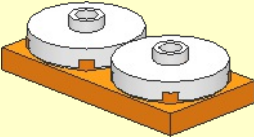

2

2x

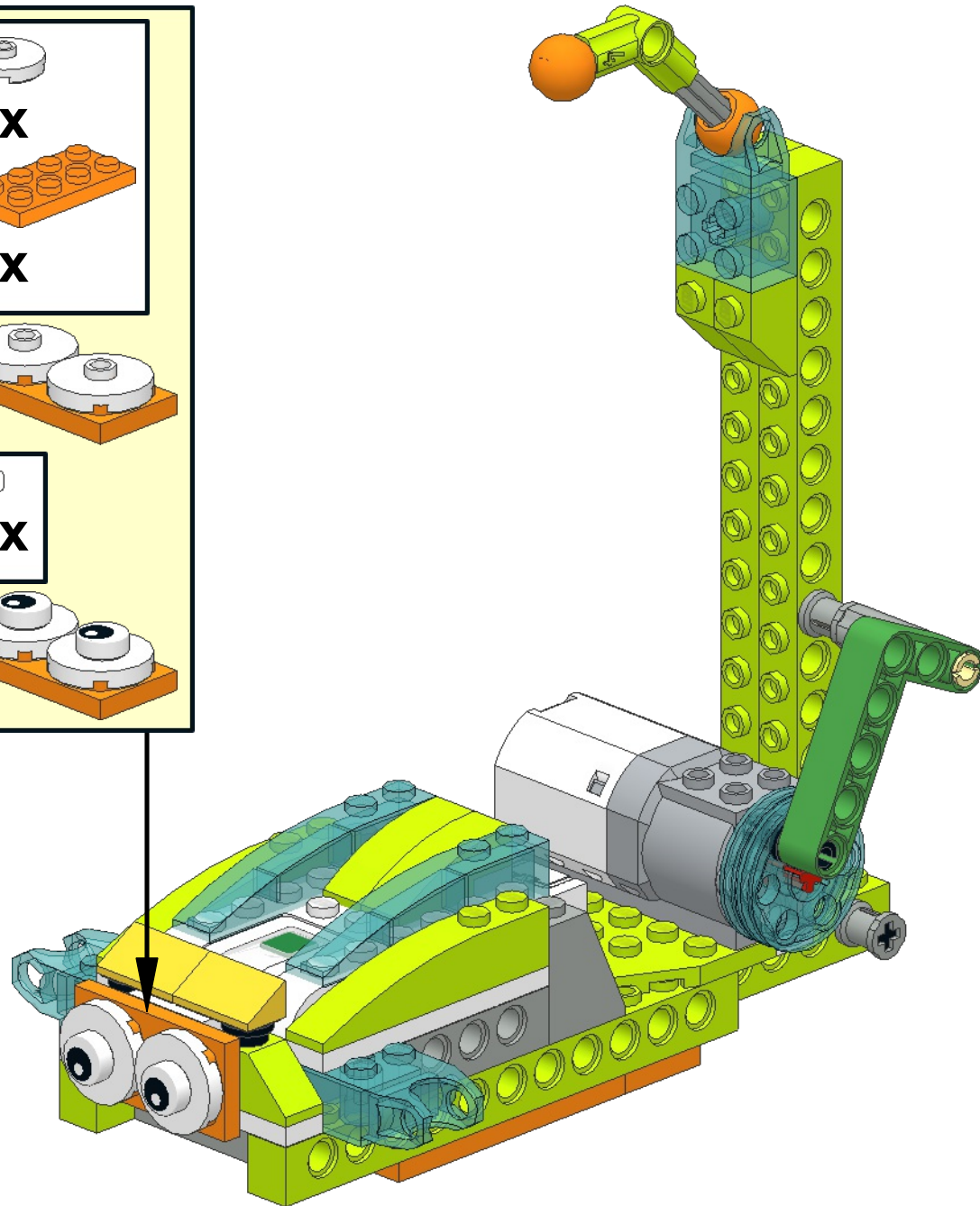
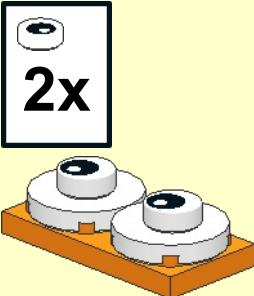

25

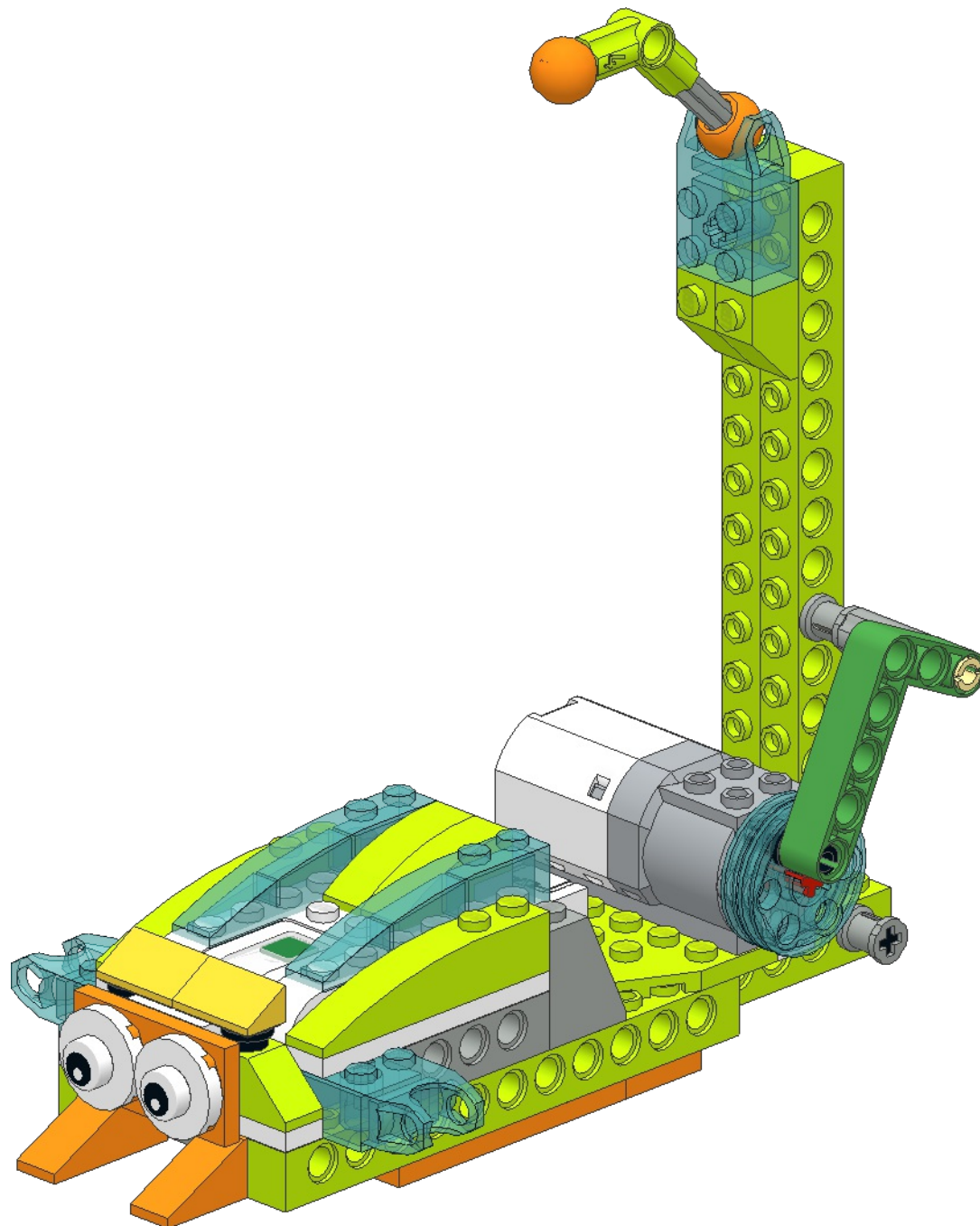
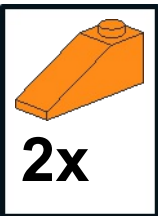

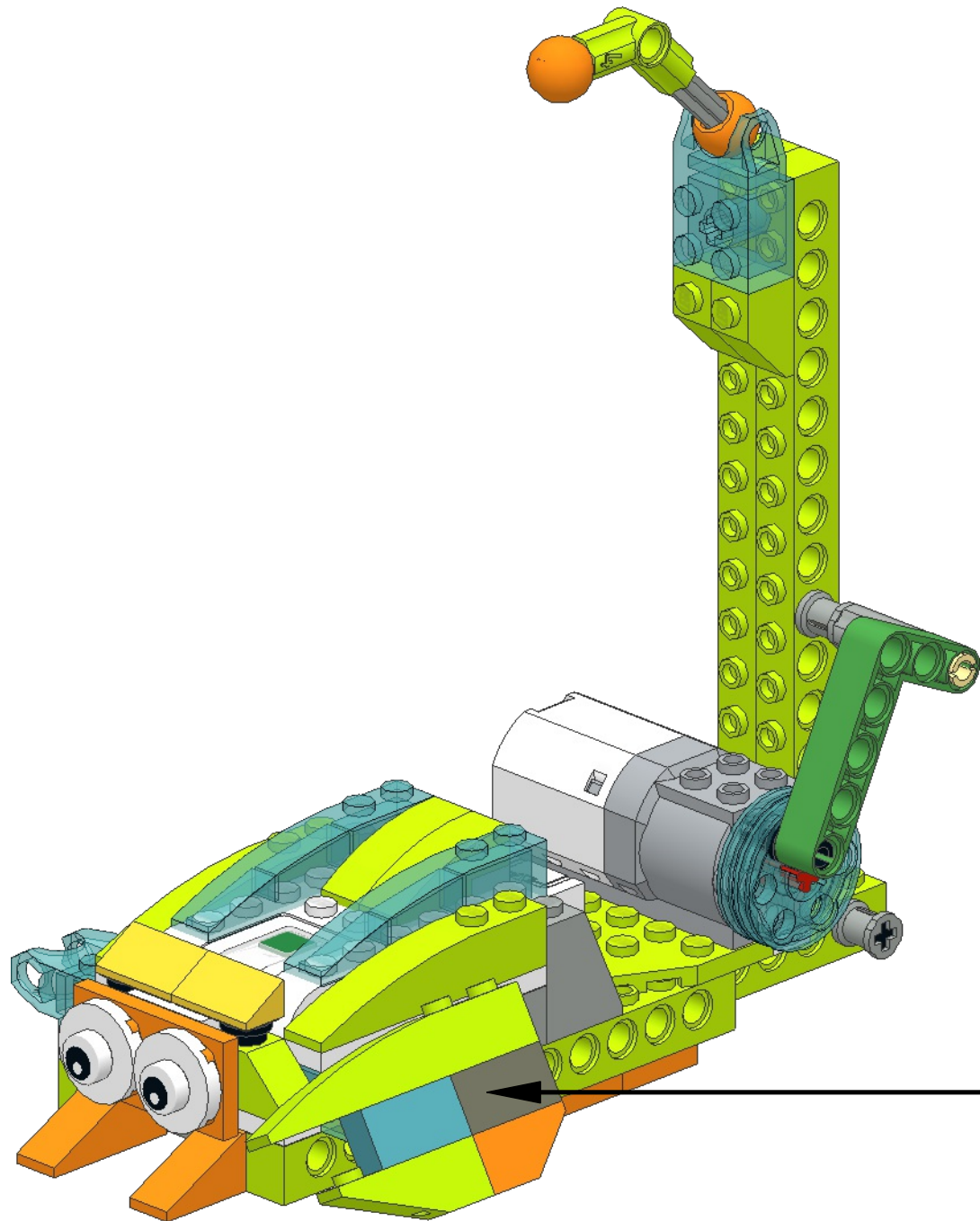

1

1x

1x 1x

2

1x 1x

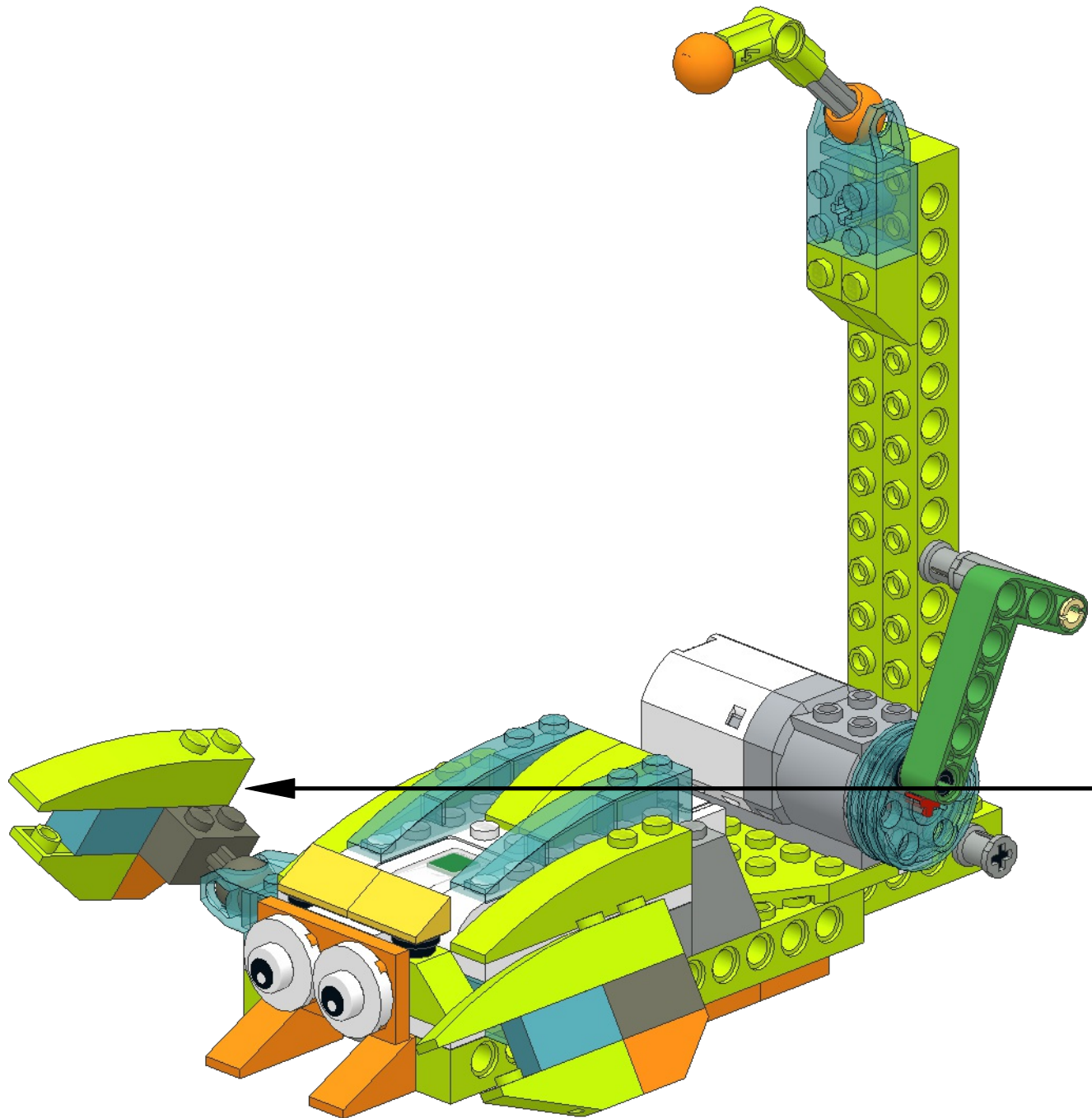

1

1x **1x** **1x**

2

1x **1x**

28

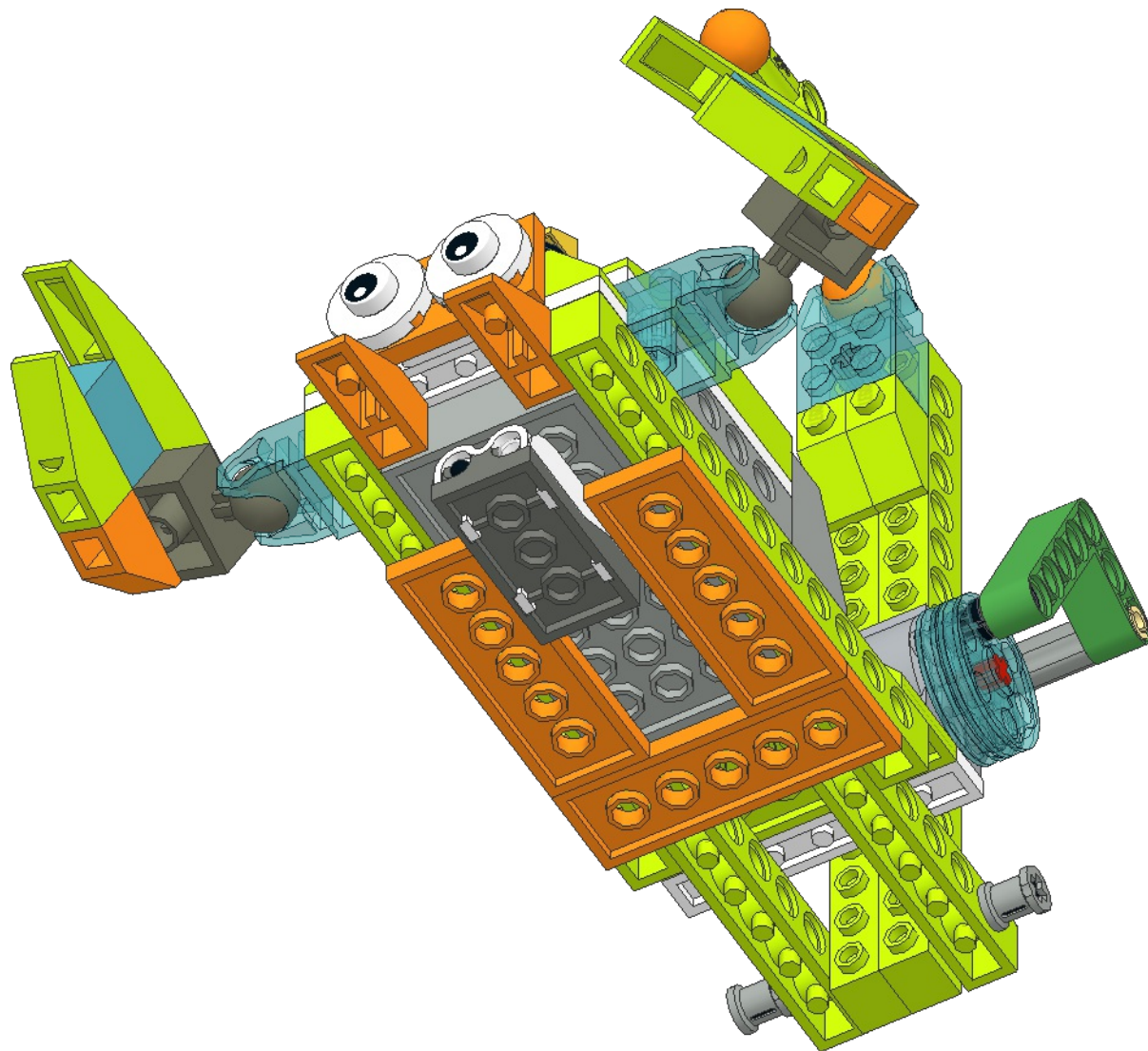
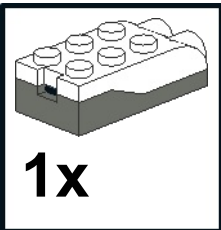

29

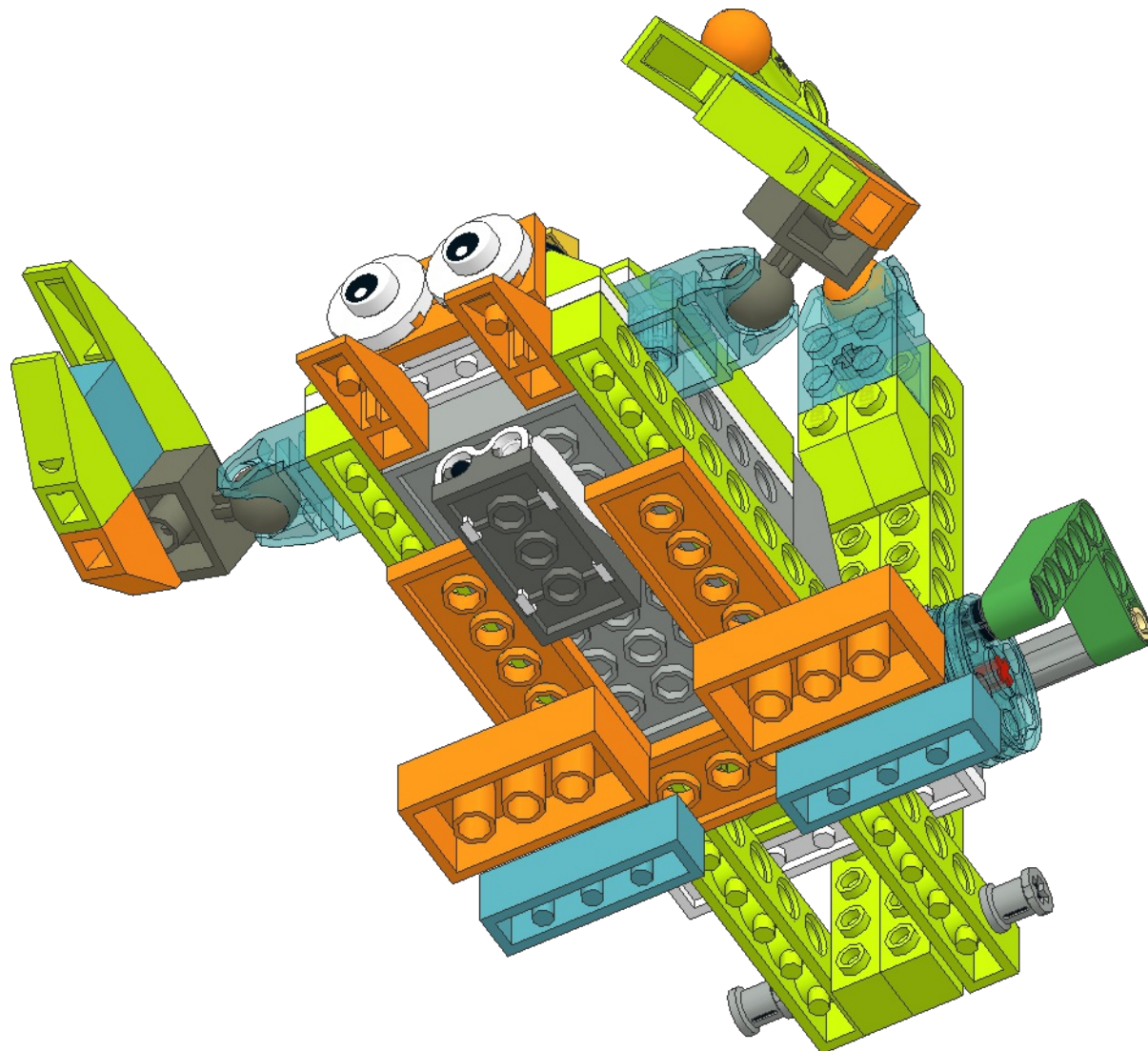
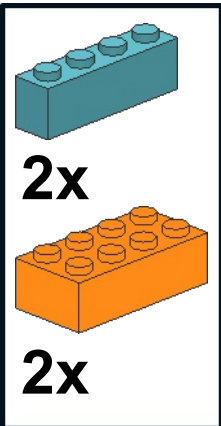

30

