

BRICK SORTER

WEDo 2.0

Instruction by Udilov Daniil

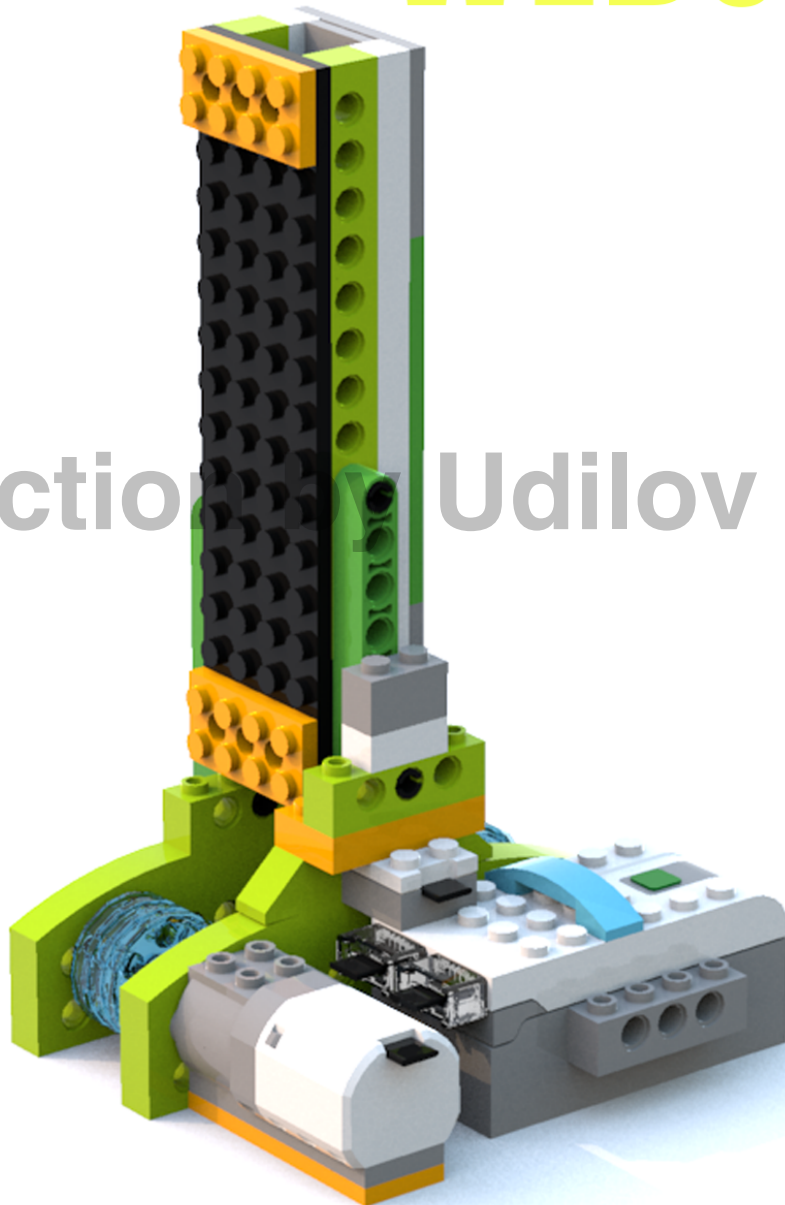

BUILDING INSTRUCTION + PROGRAM

BY UDILOV DANIL

1

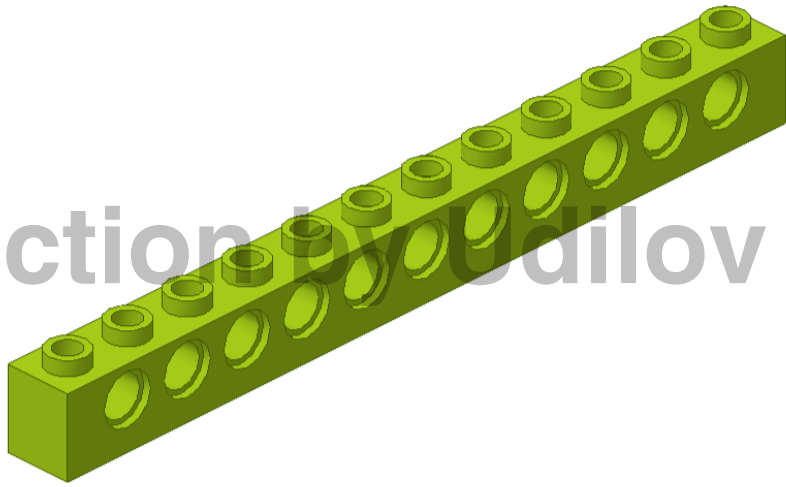
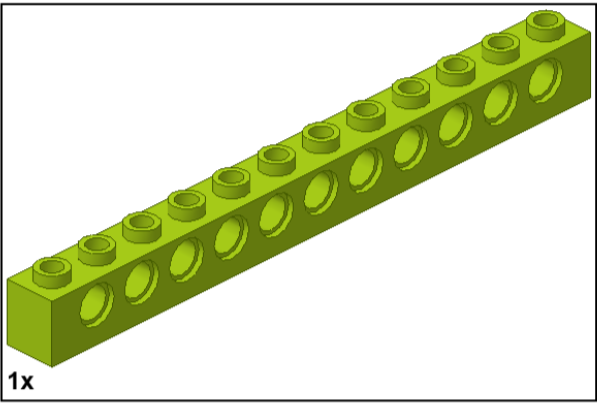

Instruction by Udilov Daniil

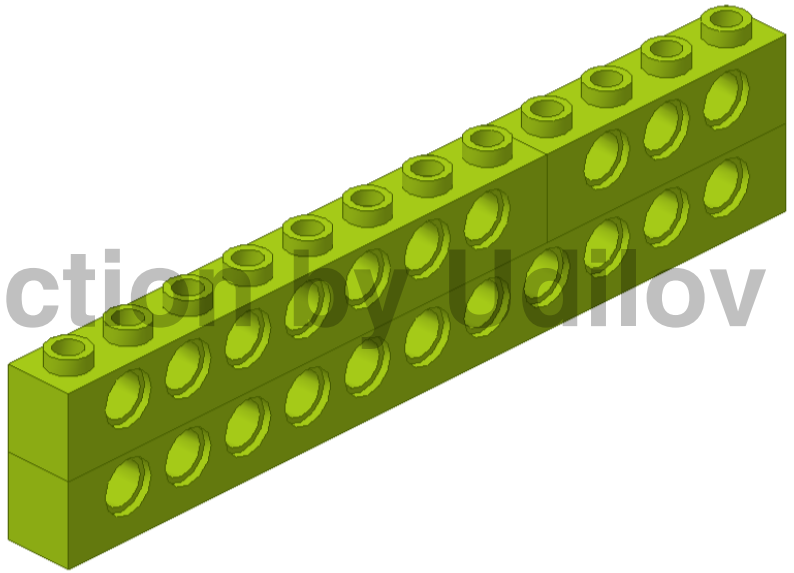
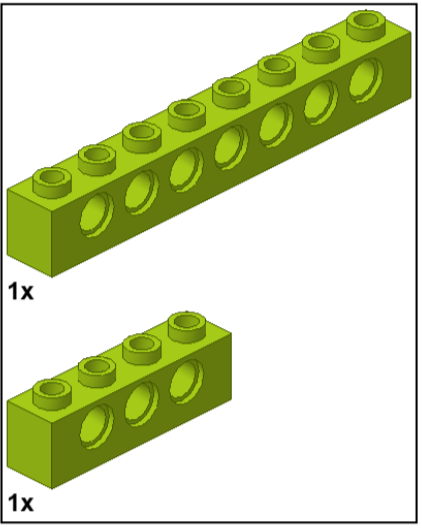

Instruction by Уеллов Daniil

3

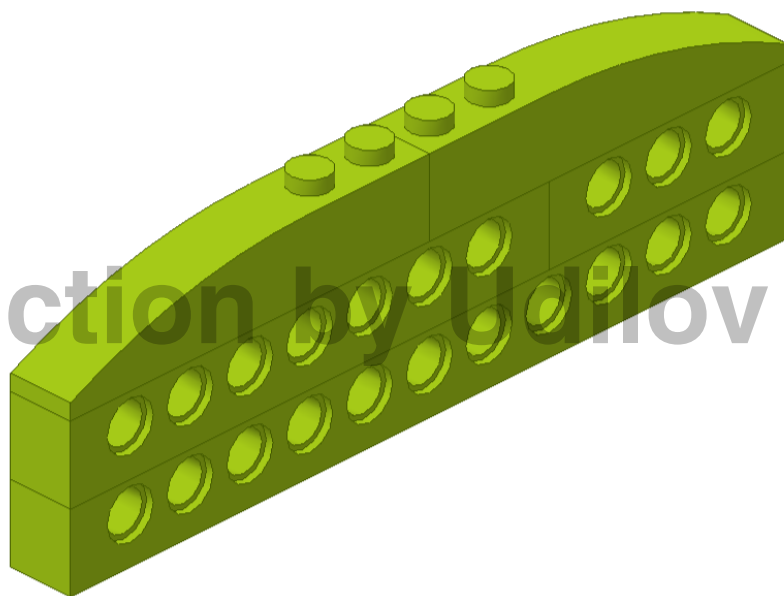
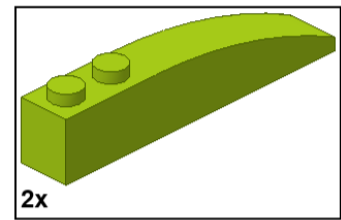

Instruction by Ushilov Daniil

4

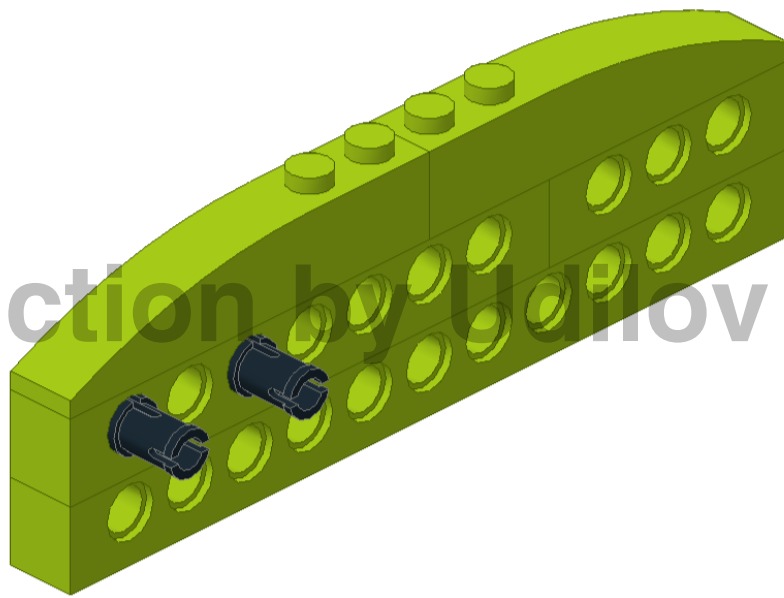
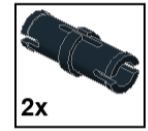

Instruction by Ushakov Daniil

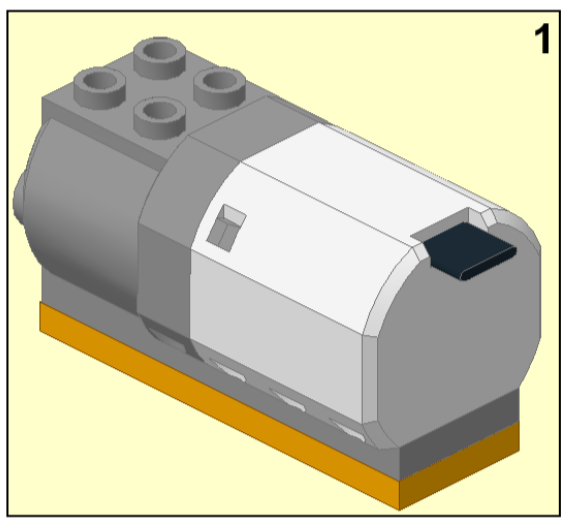
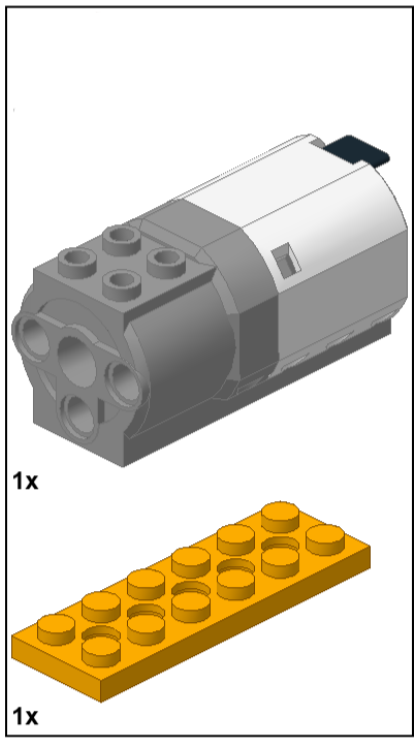

Instruction by Uelliov Daniil

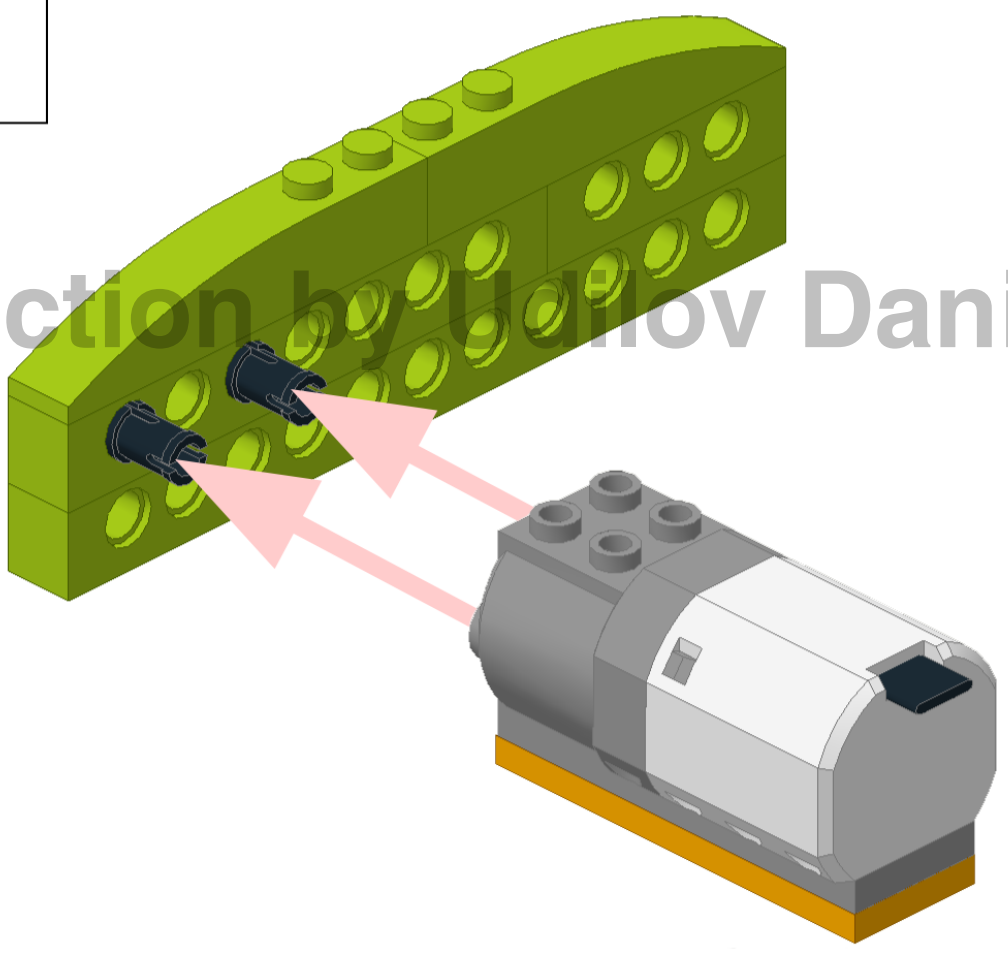

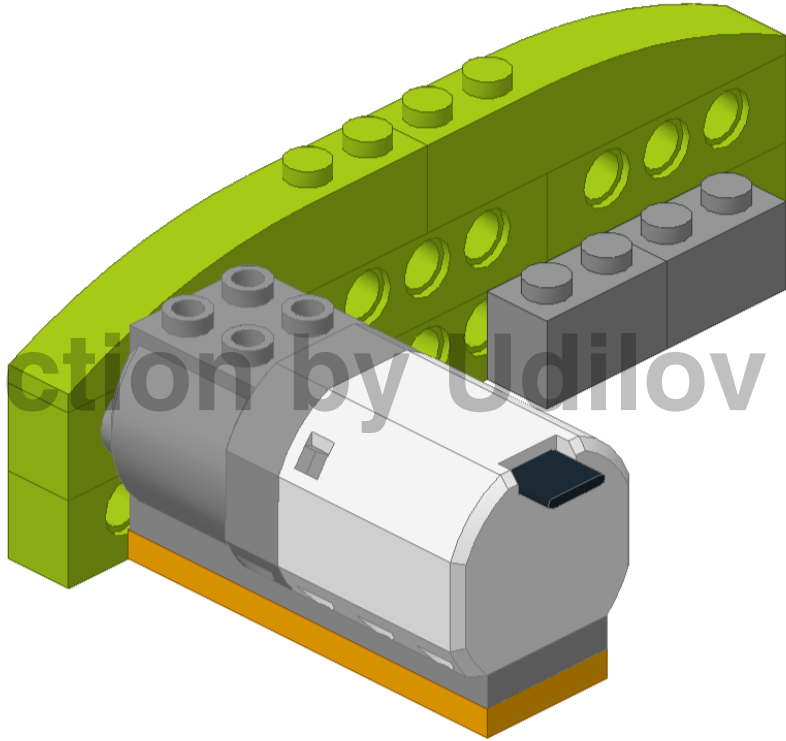
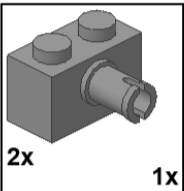

Instruction by Udilov Daniil

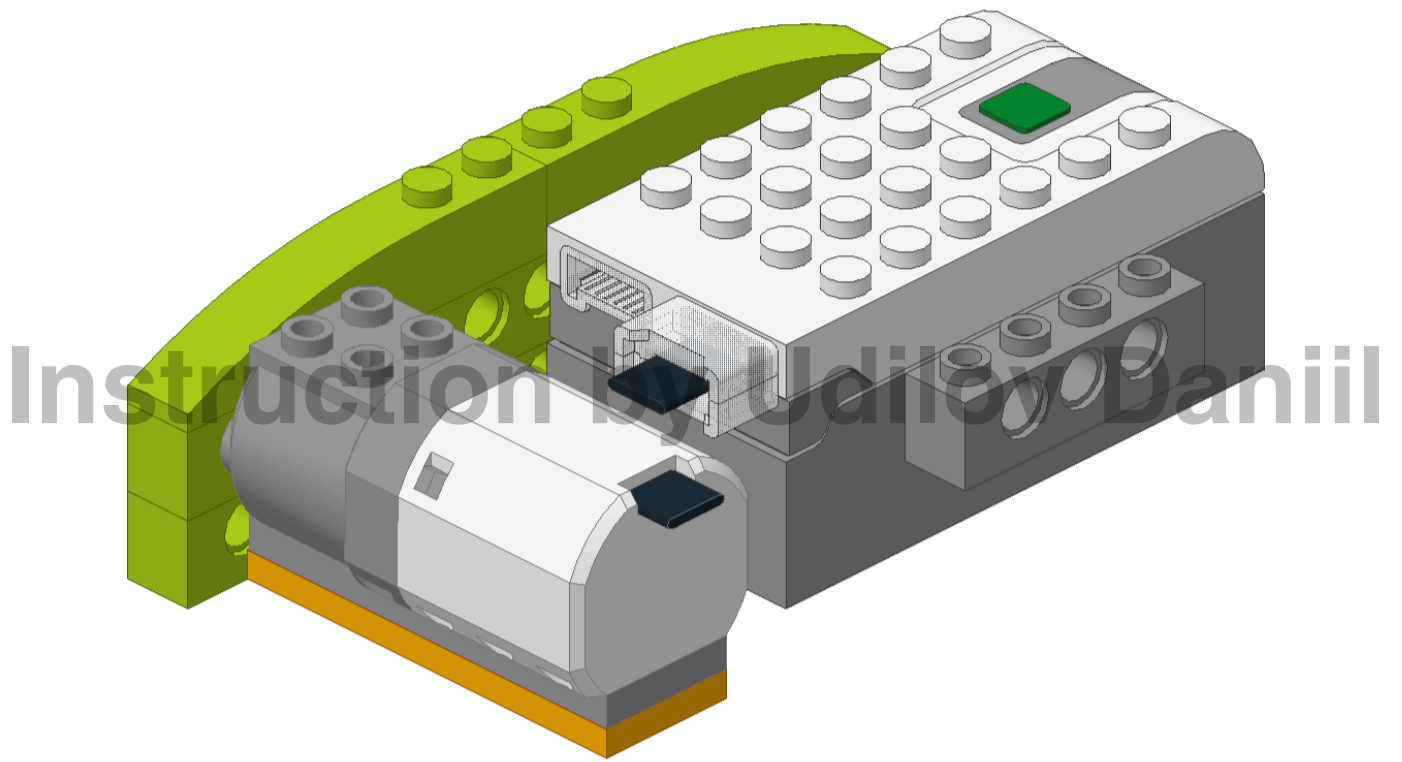
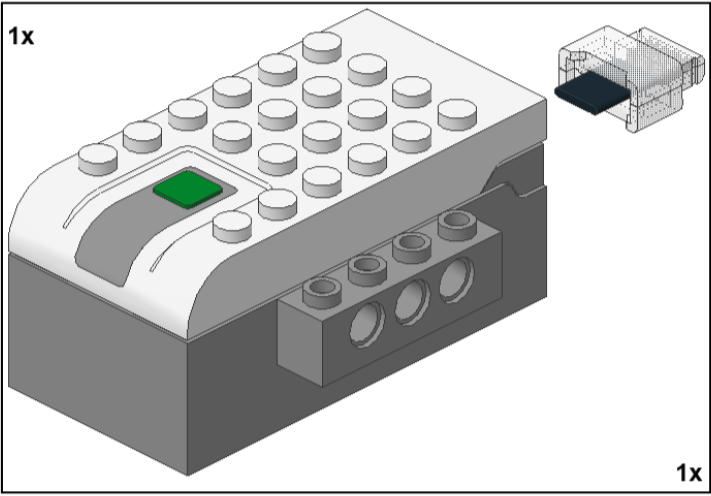

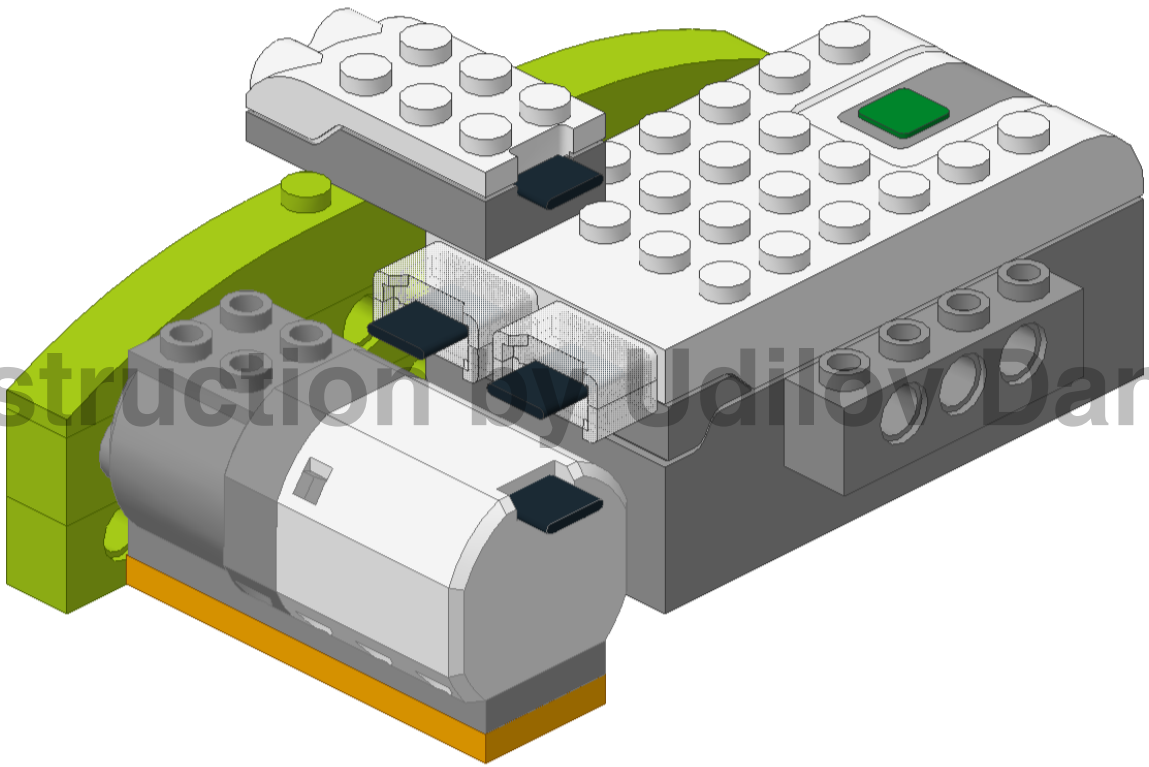
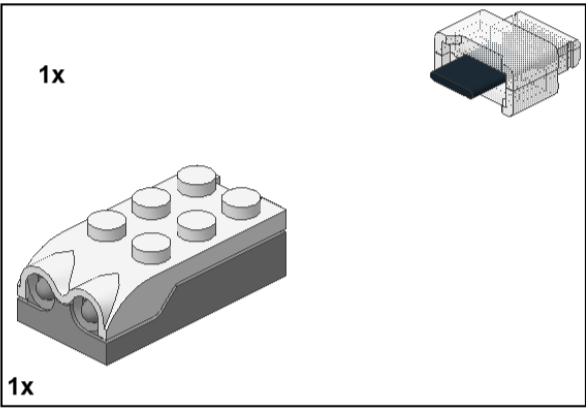

Instruction by Udilov Daniil

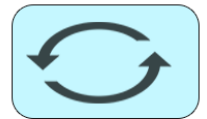
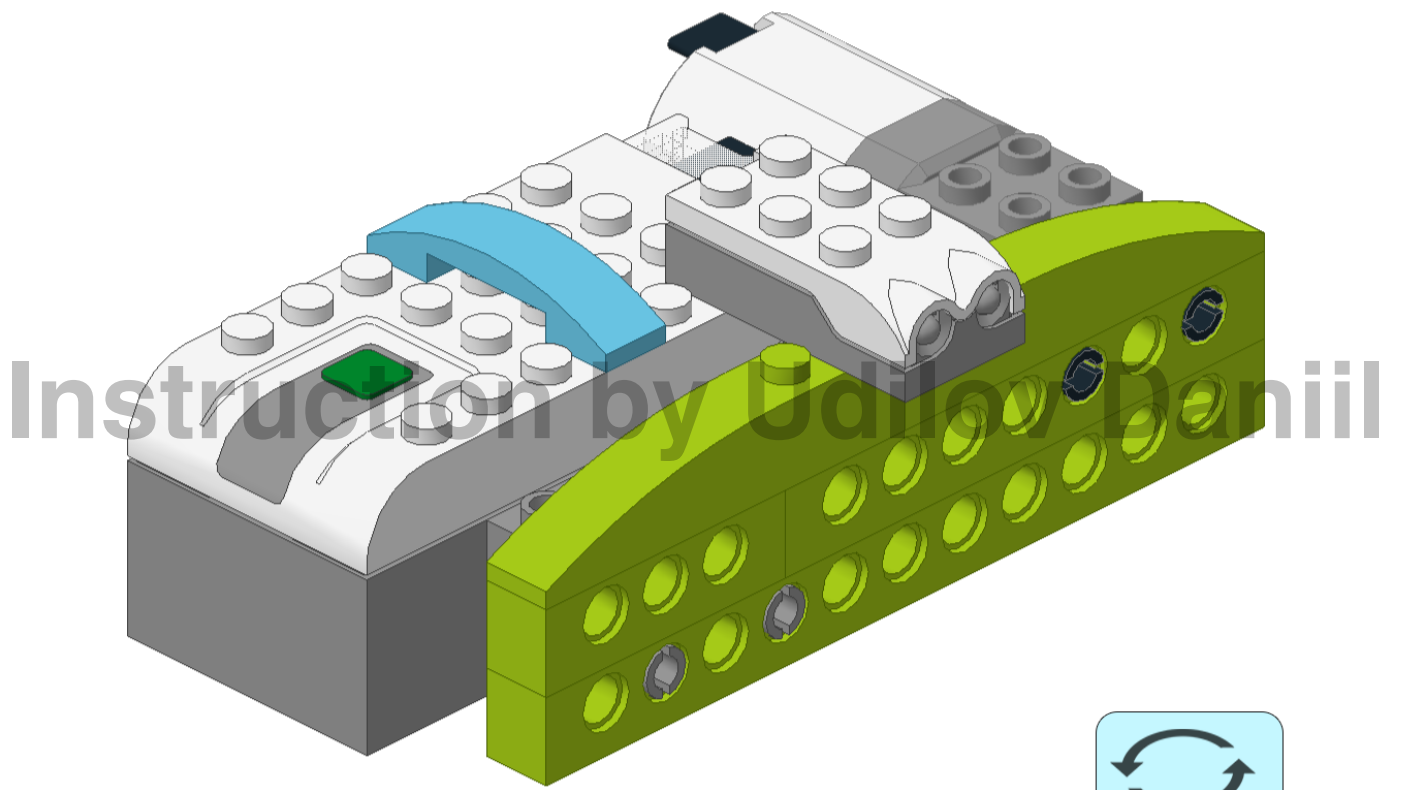
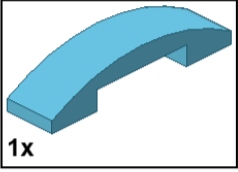

1

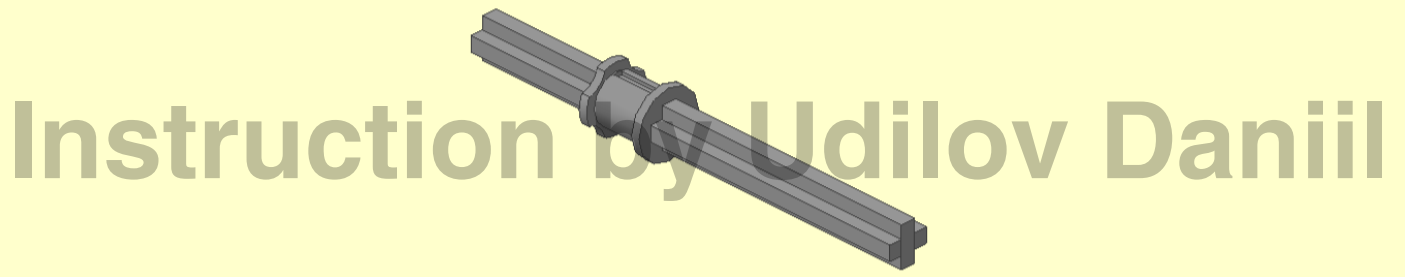
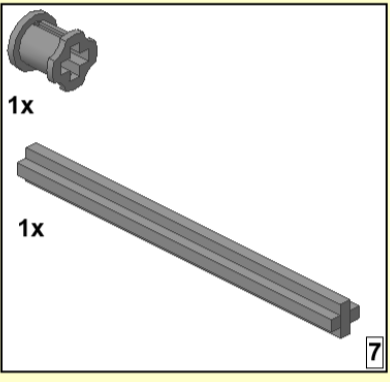

2

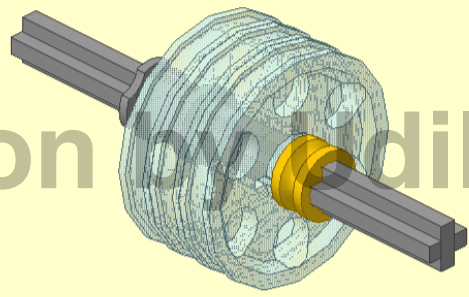
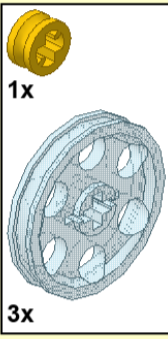

Instruction by **Yuridilov Daniil**

3

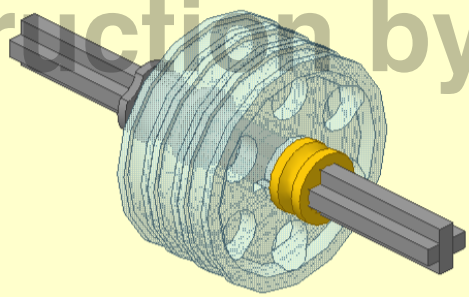
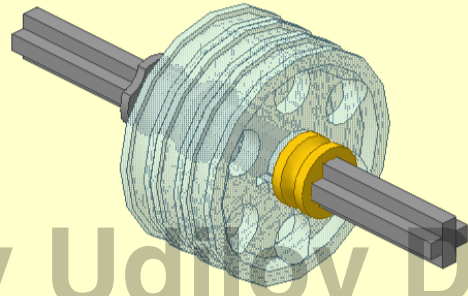
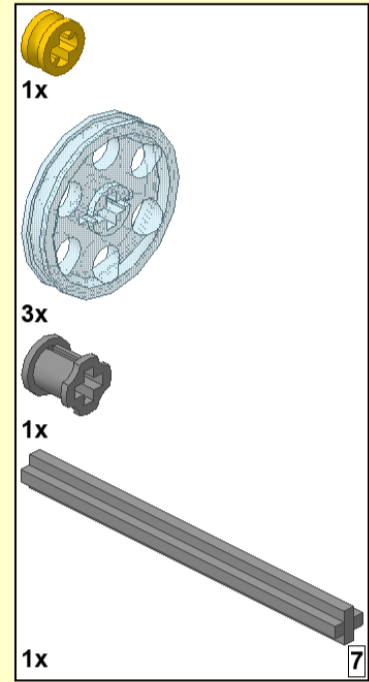

Instruction by Udilov Daniil

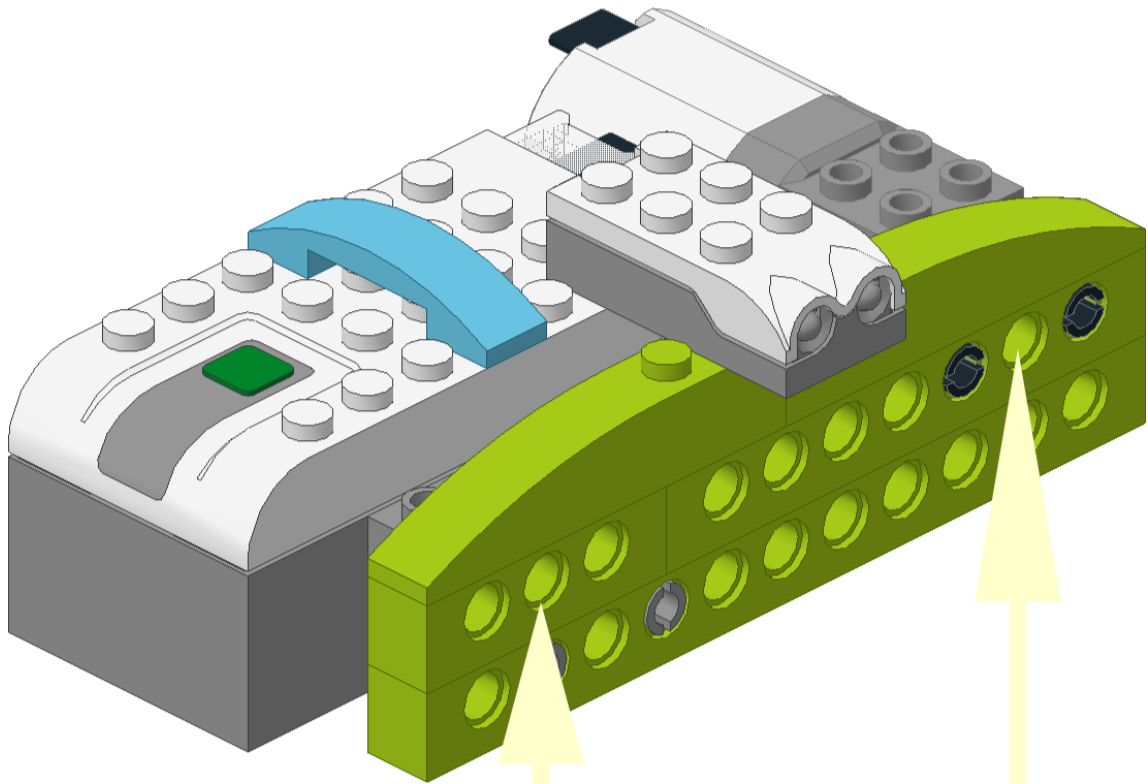

Instruction by Udilov Daniil

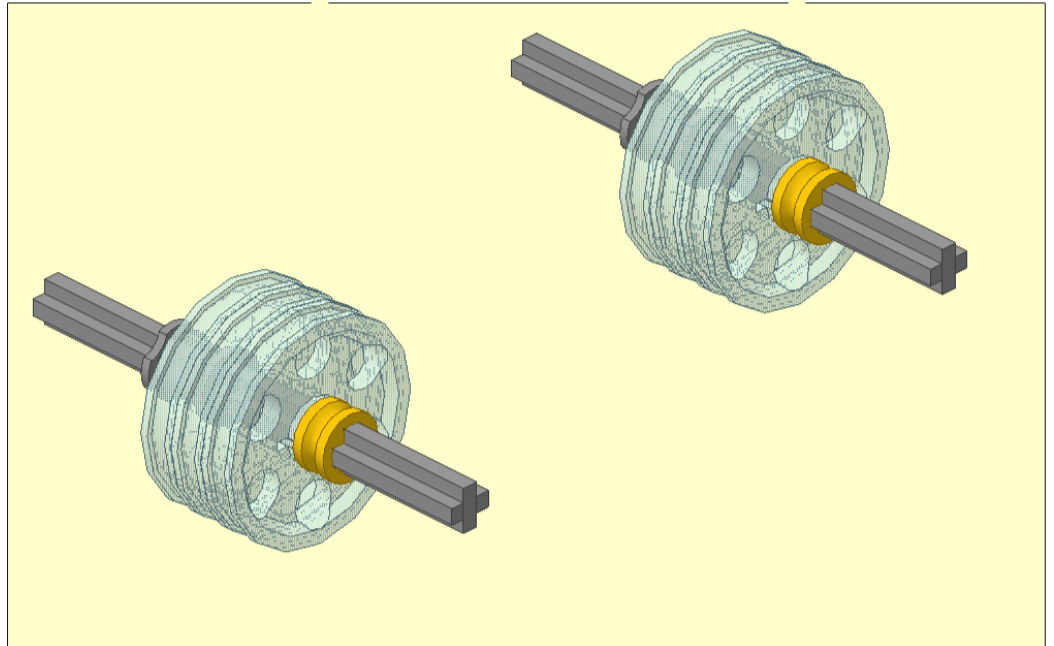

10

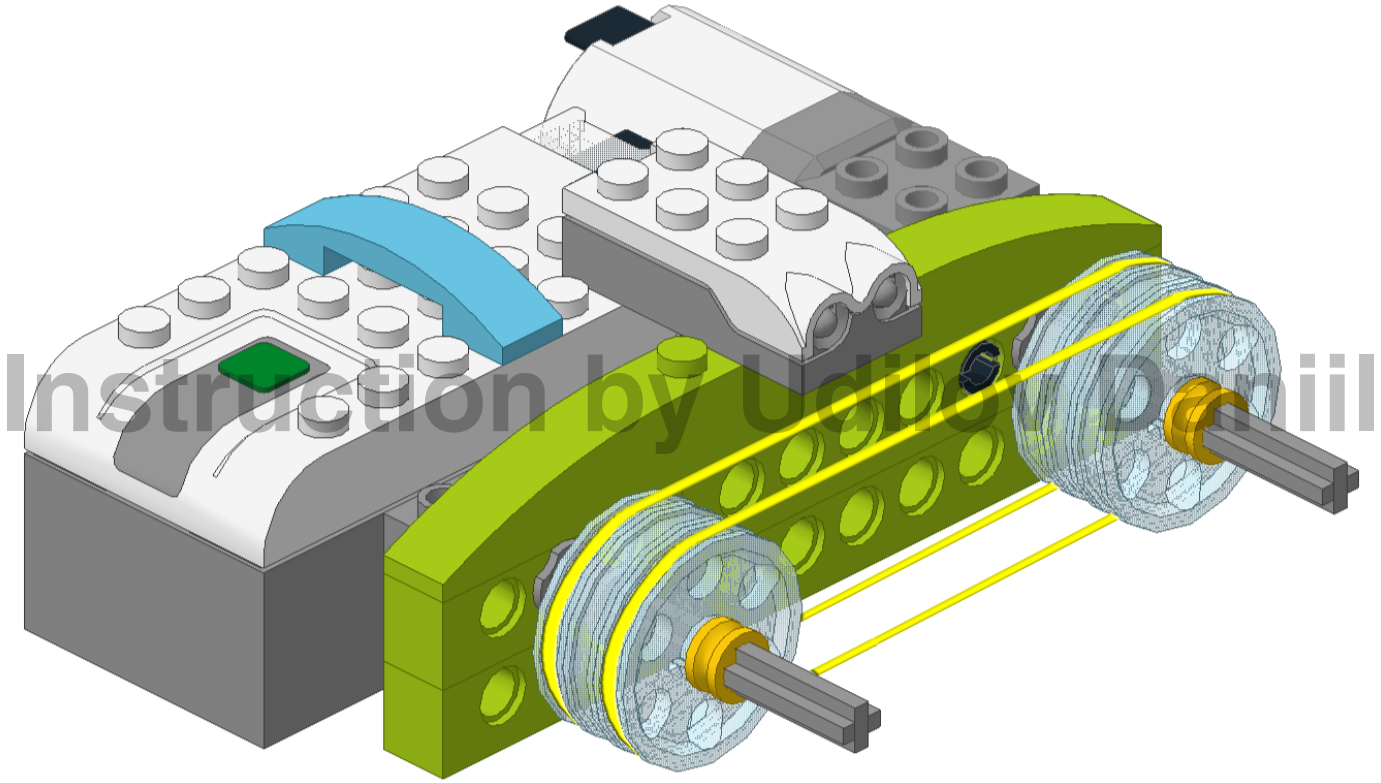
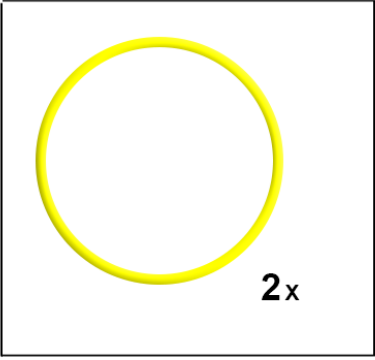

11

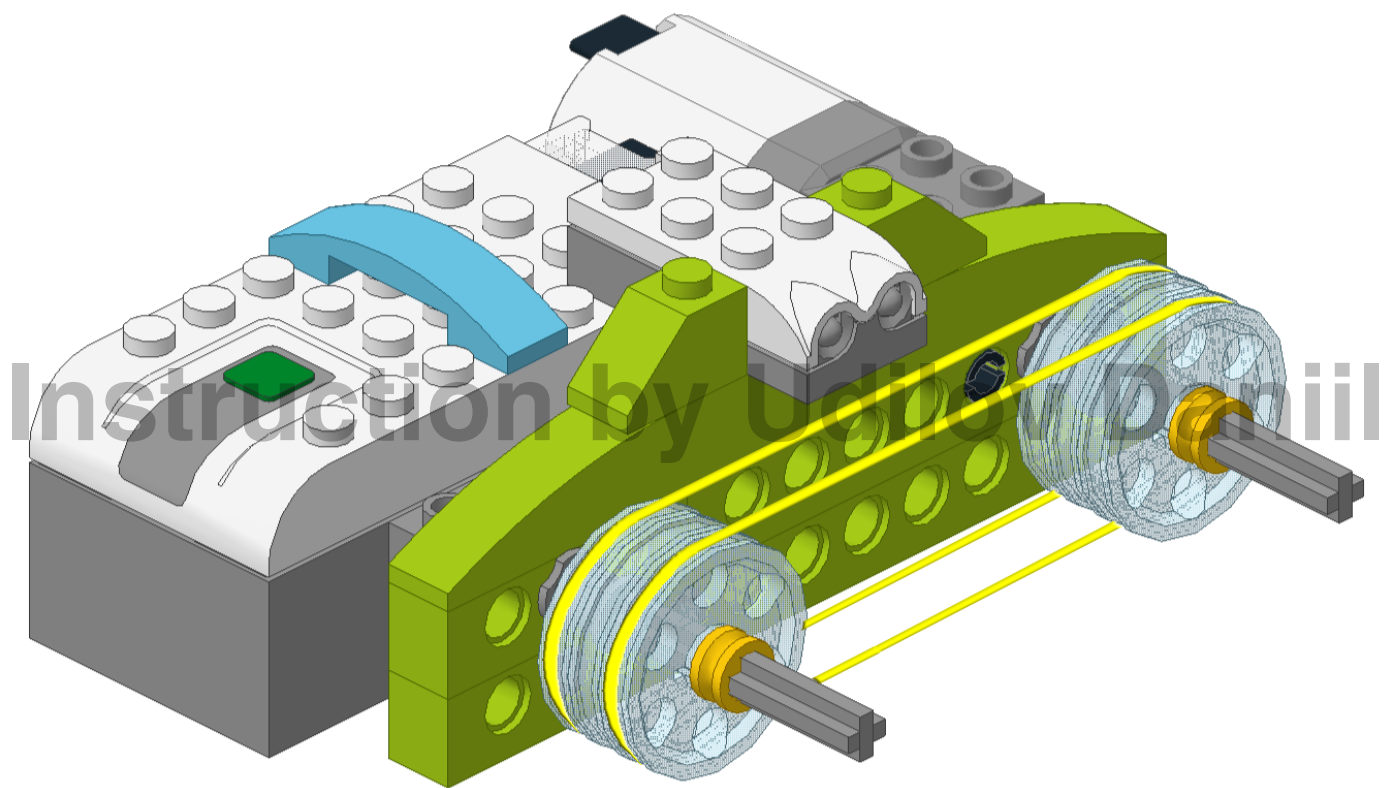
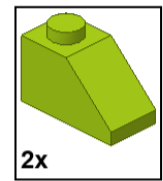

1

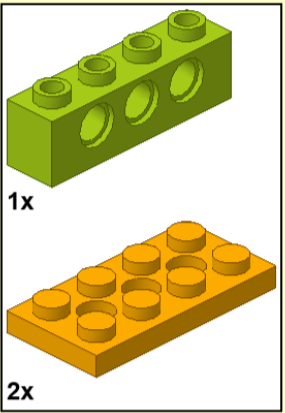

Instruction by Boilov Daniil

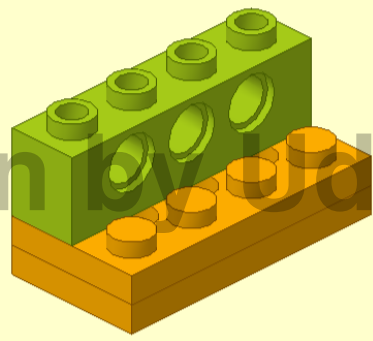

2

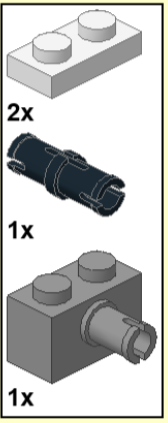

Instruction by Dilov Daniil

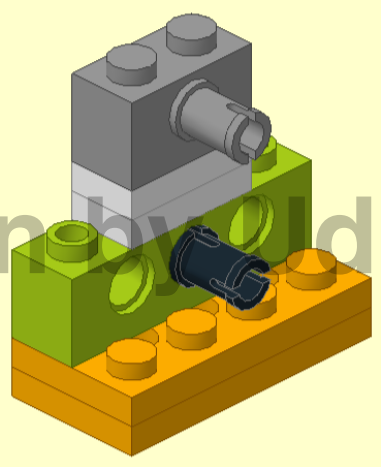

3

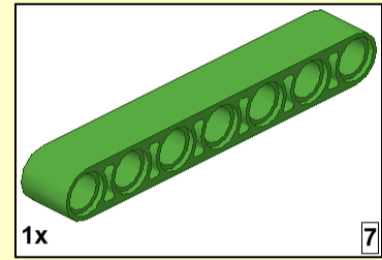

Instruction by Jdilov Daniil

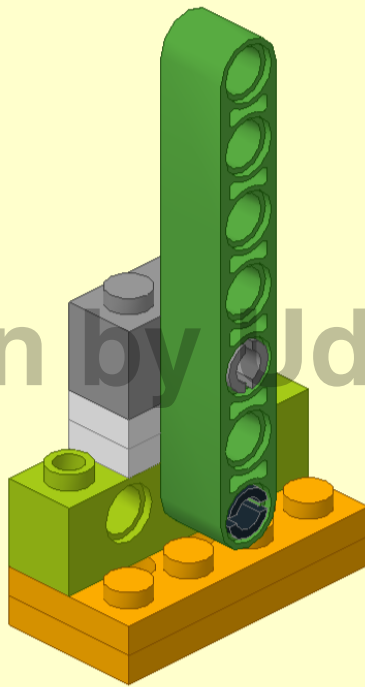

4



Instruction by Jdilov Daniil

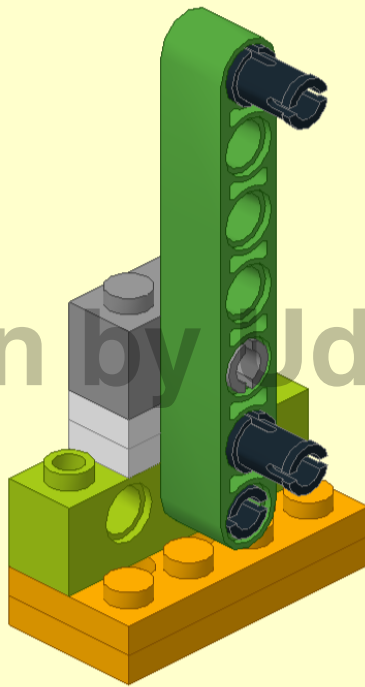

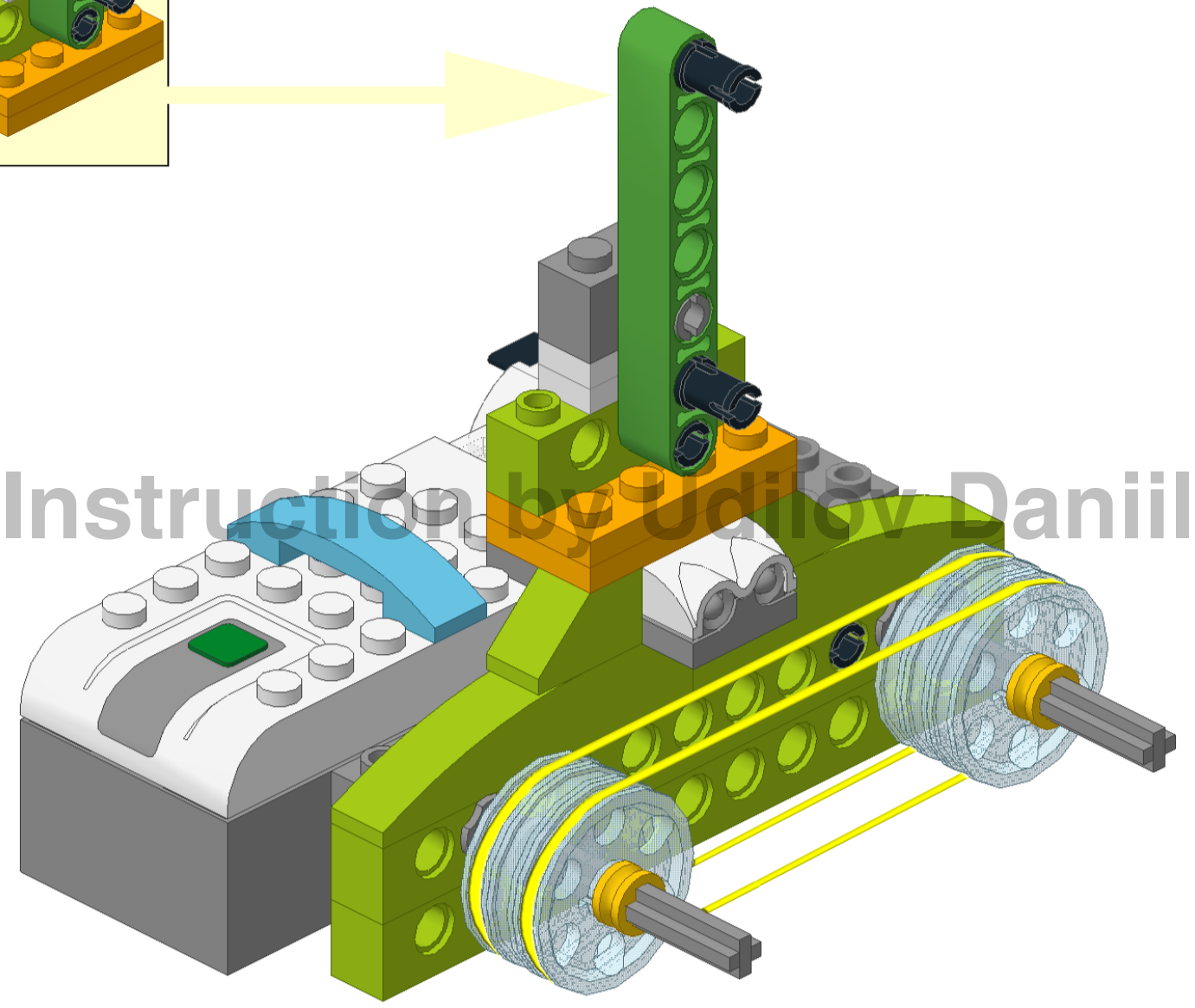
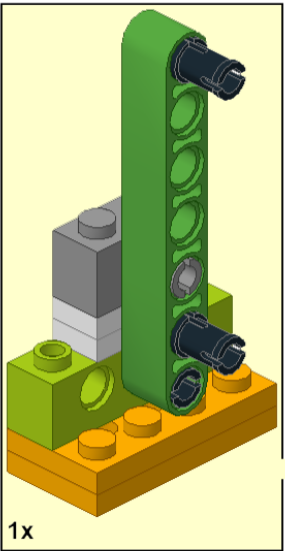

Instruction by Udilov Daniil

1

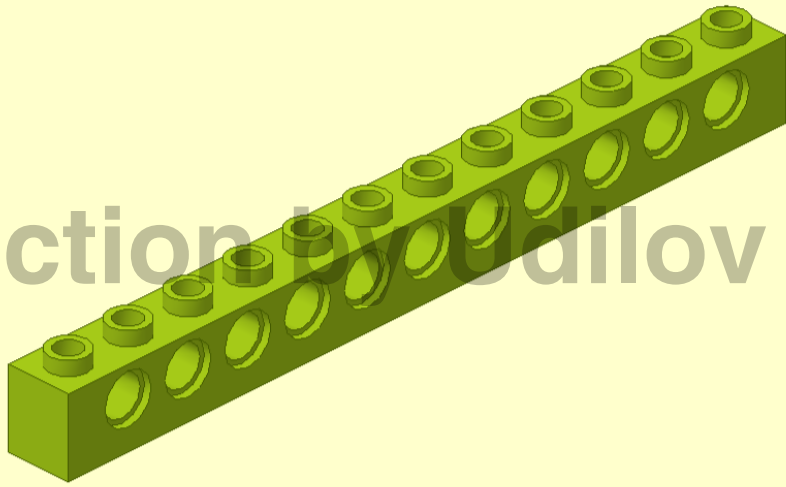
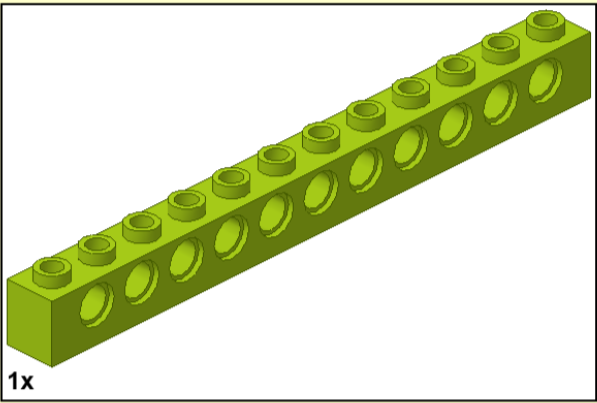

Instruction by Udilov Daniil

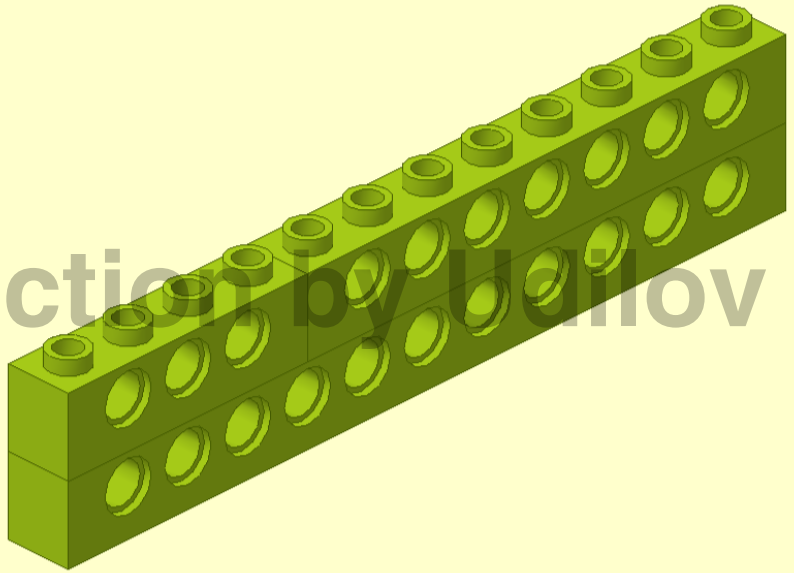
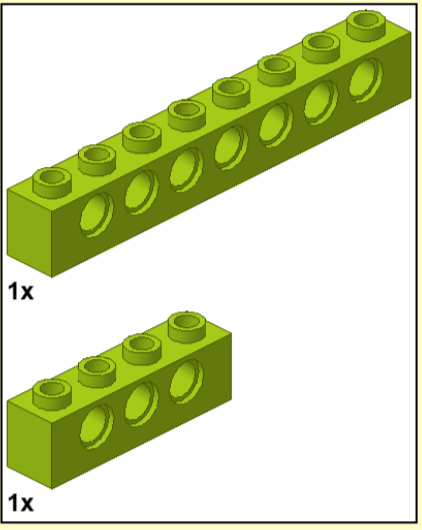

Instruction by Ushilov Daniil

3

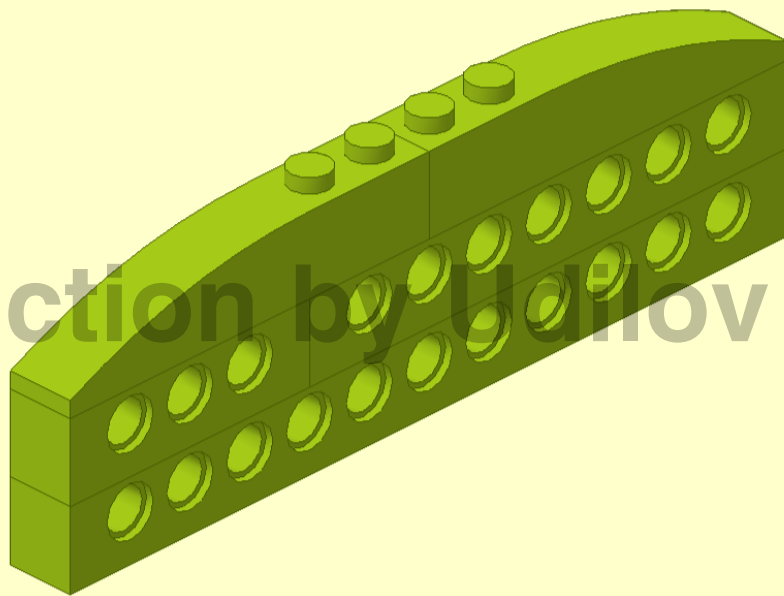
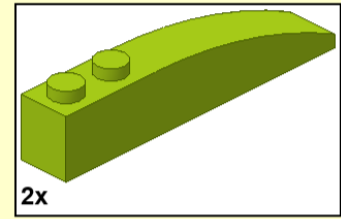

Instruction by Ushilov Daniil

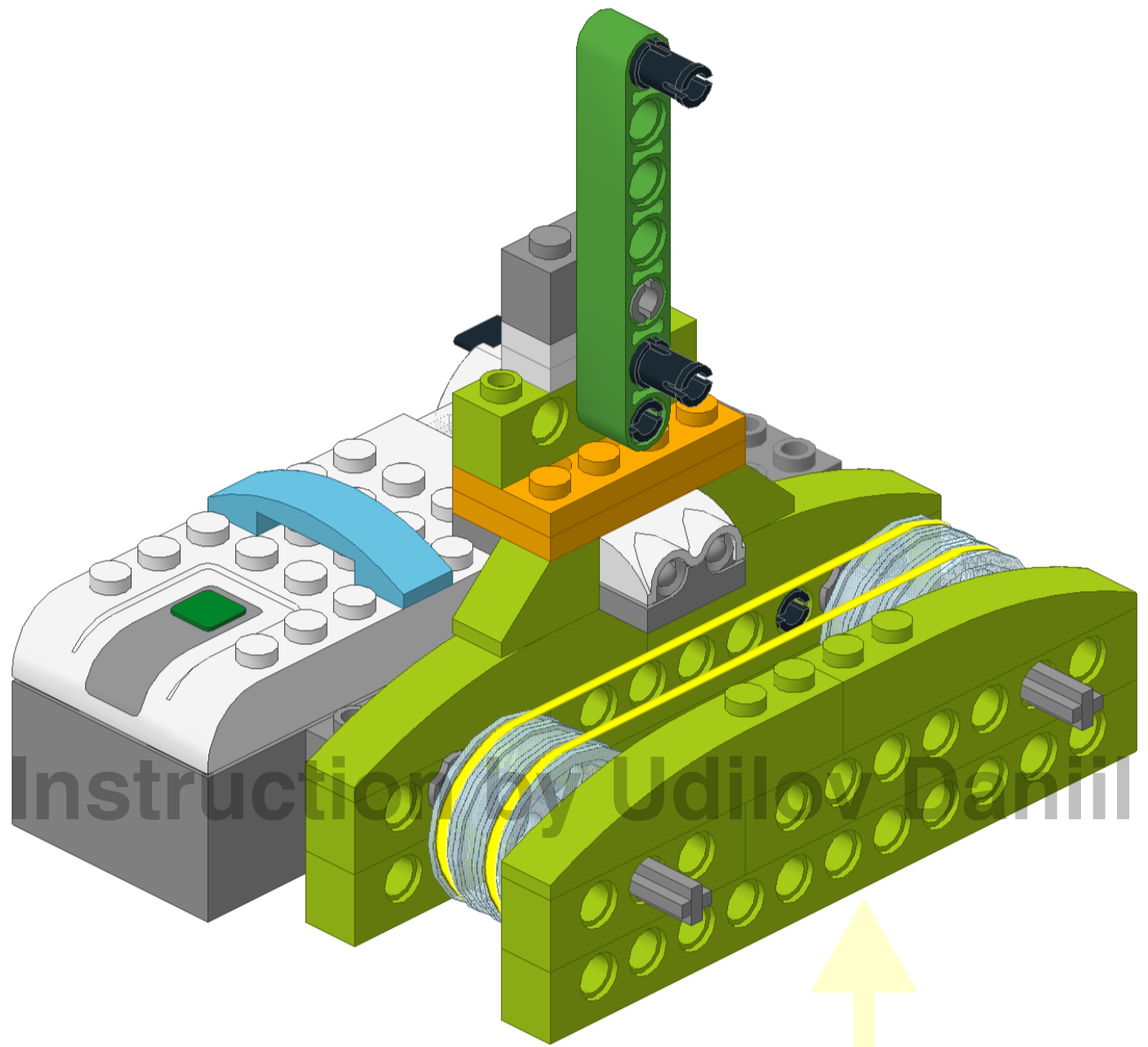

Instruction by Udilov Daniil

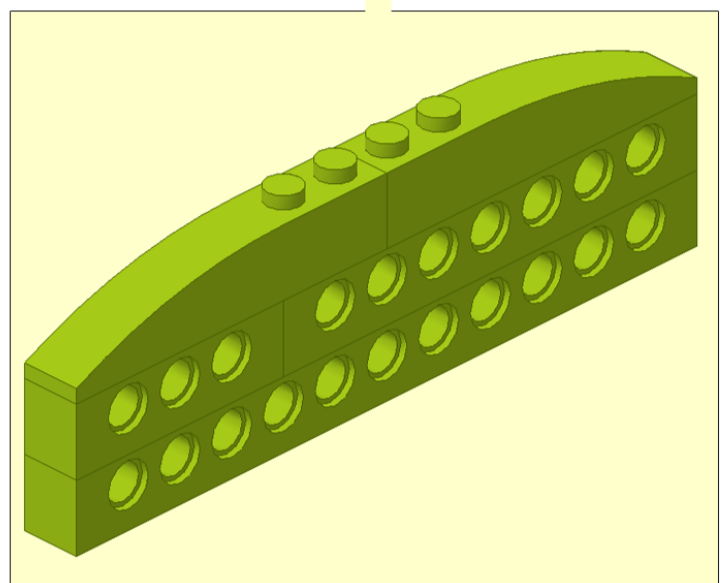

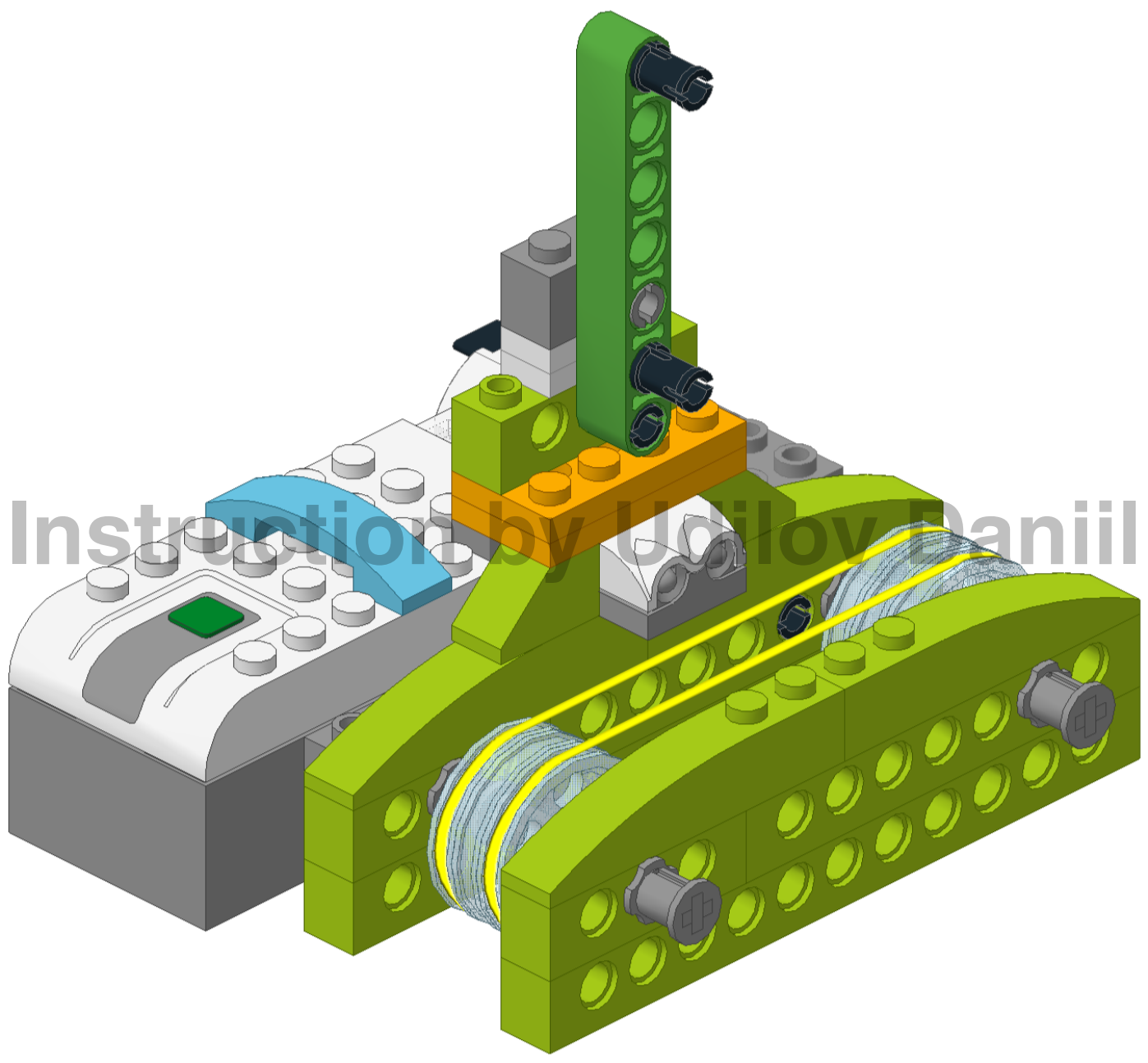
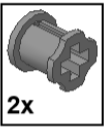

15

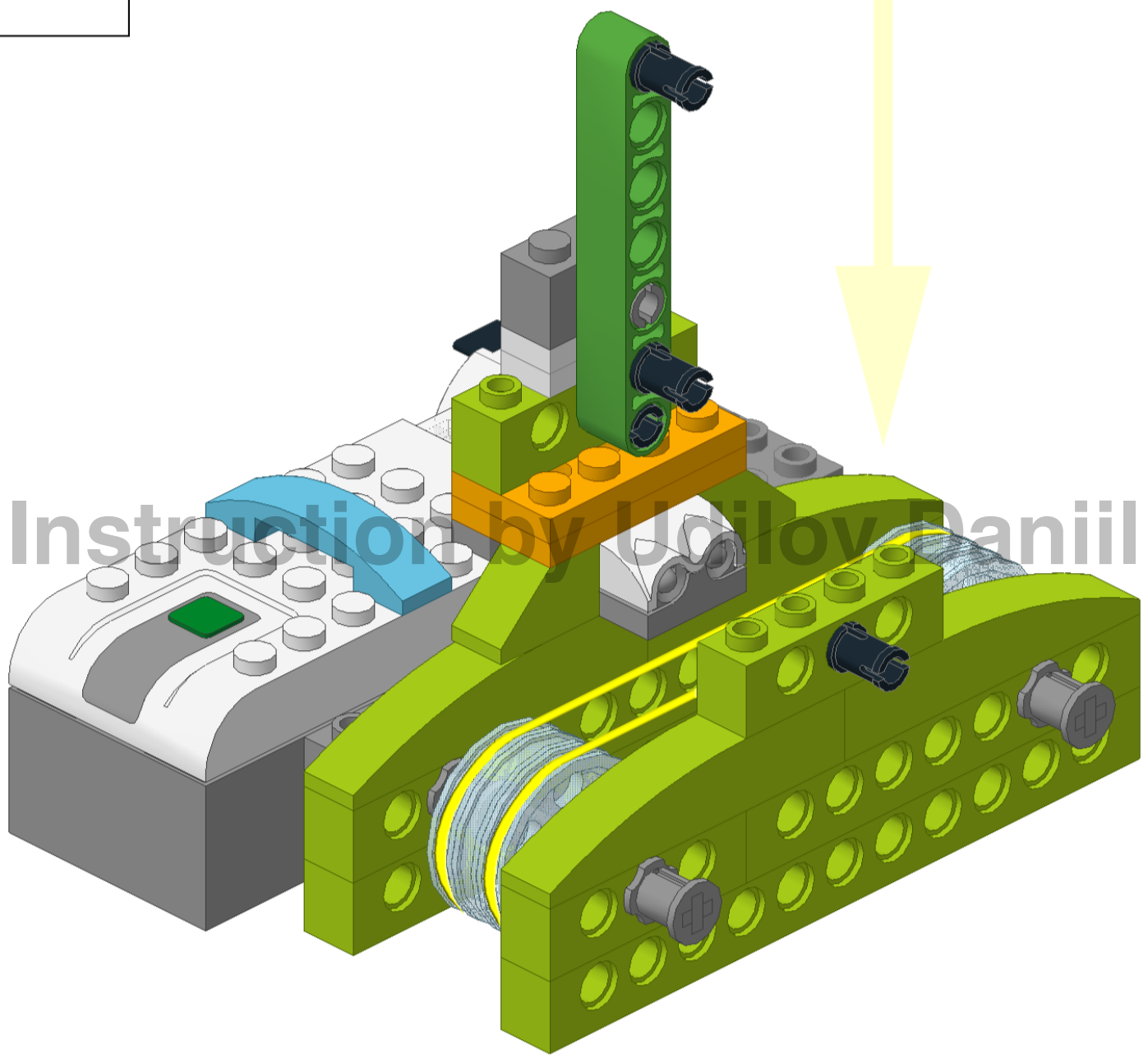
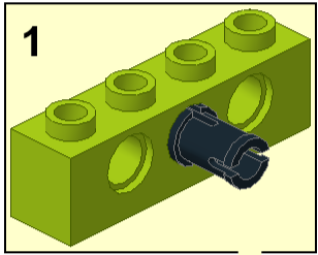
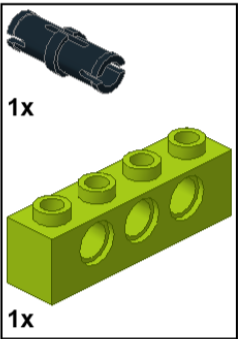

Instruction by Udirov Daniil

1

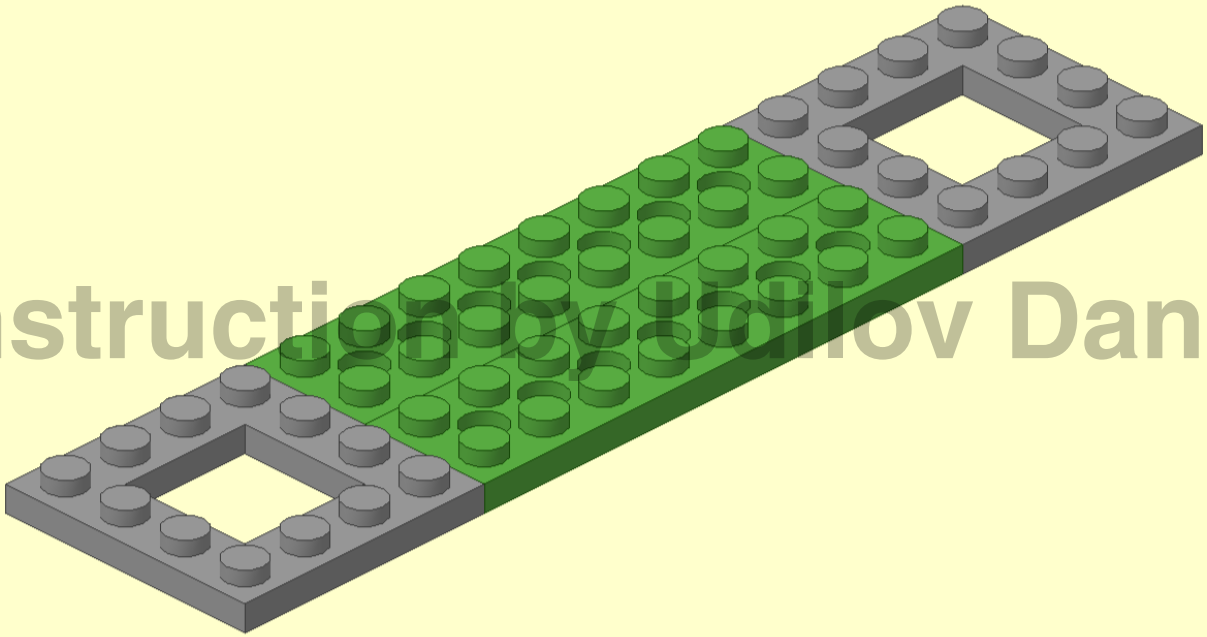
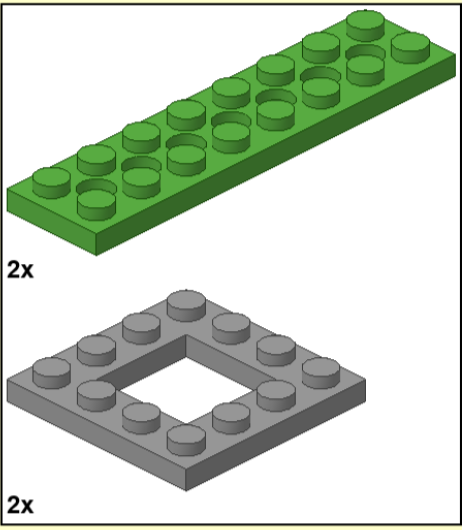

Instruction by Gollov Daniil

2

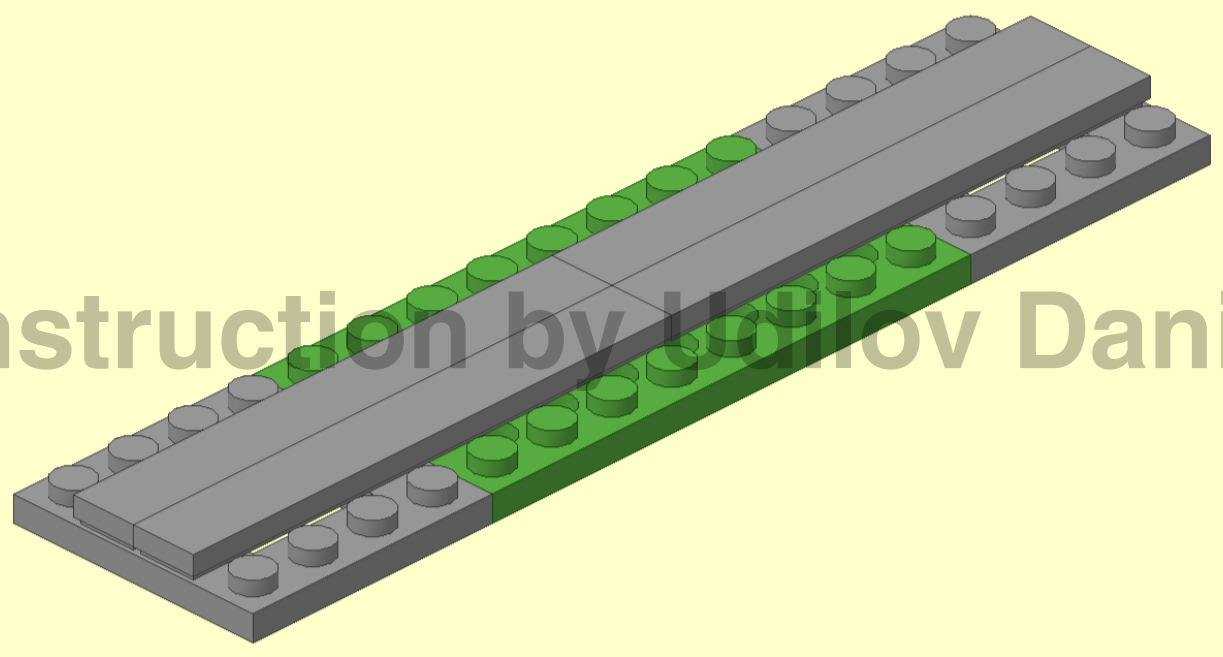
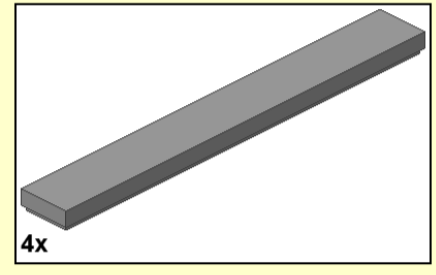

Instruction by HulloV Daniil

3

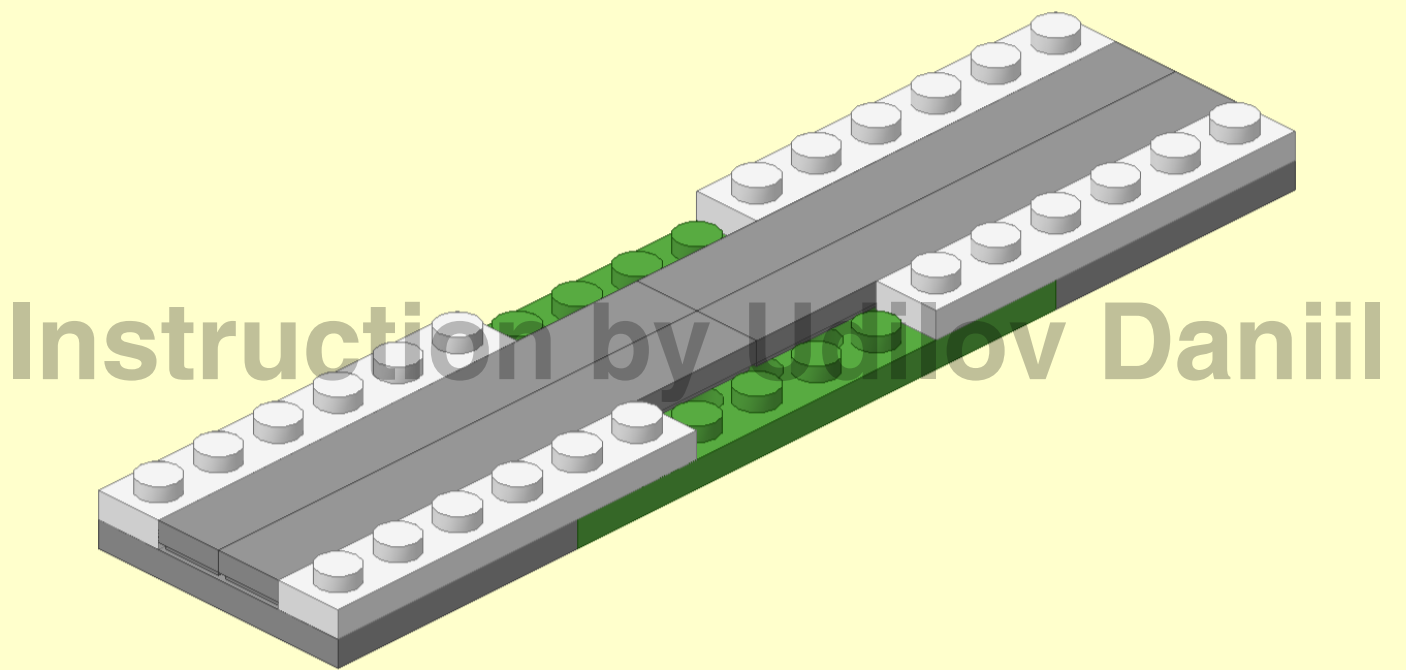
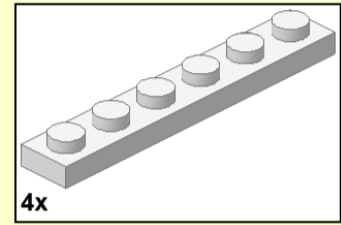

4

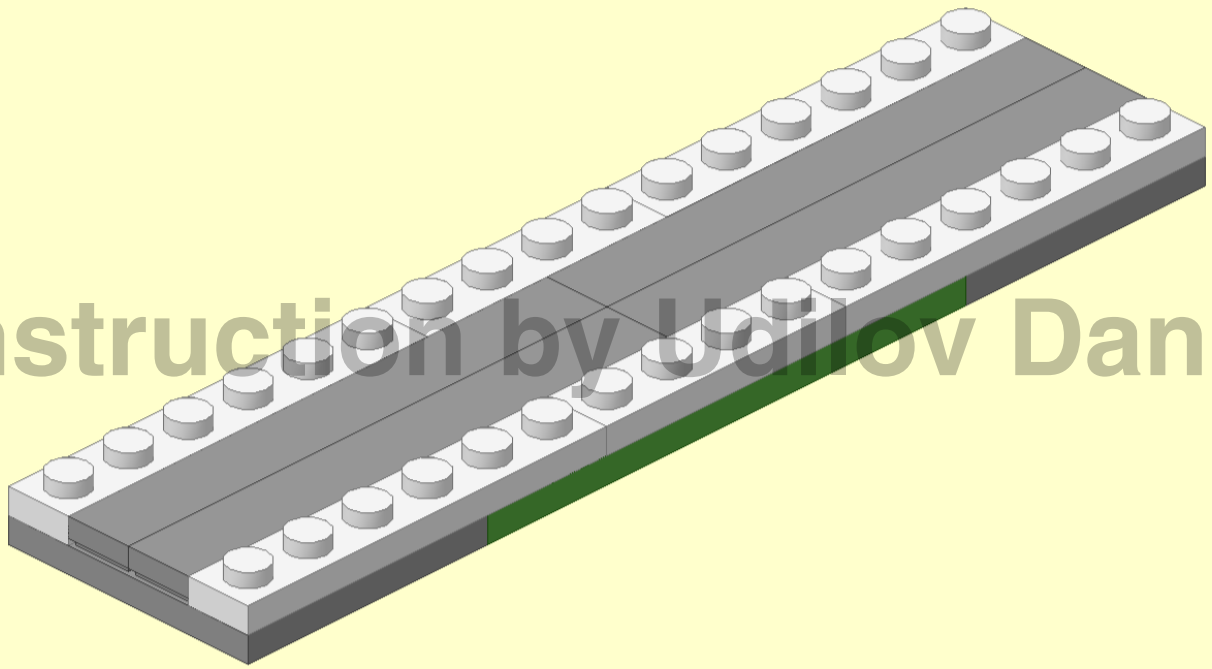
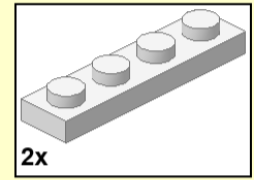

Instruction by Uollov Daniil

5

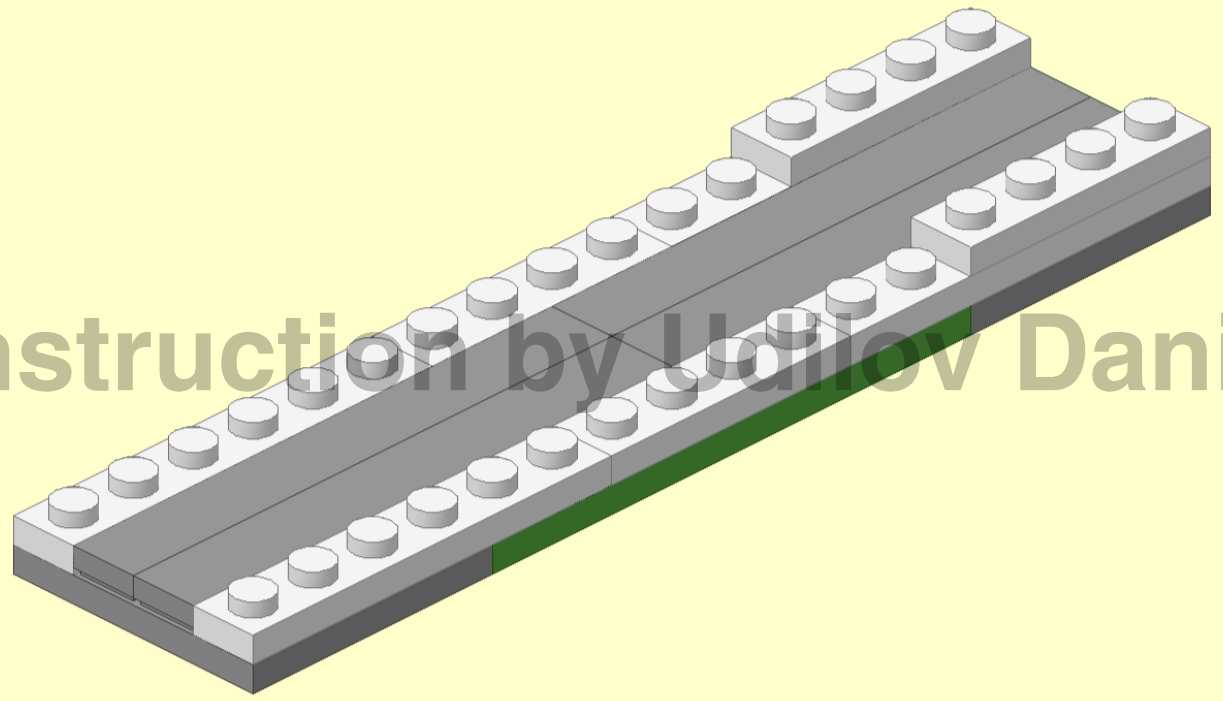
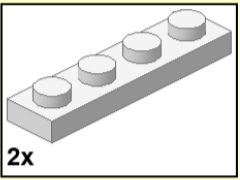

Instruction by Uallov Daniil

6

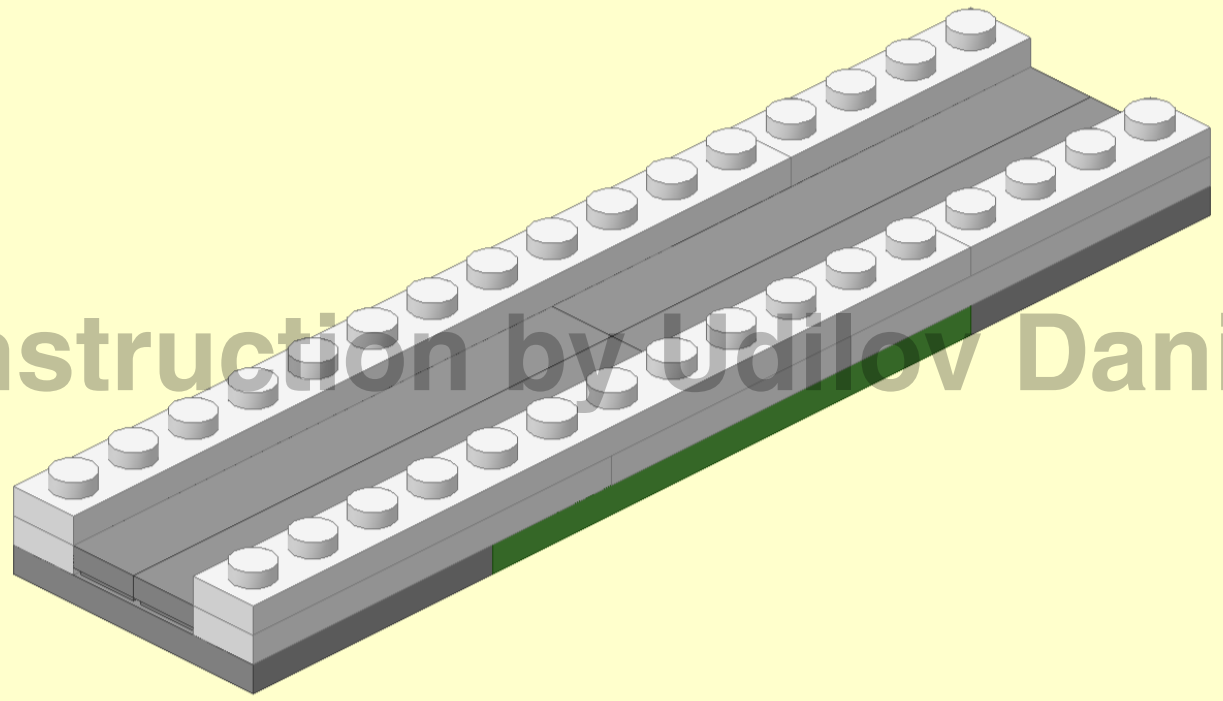
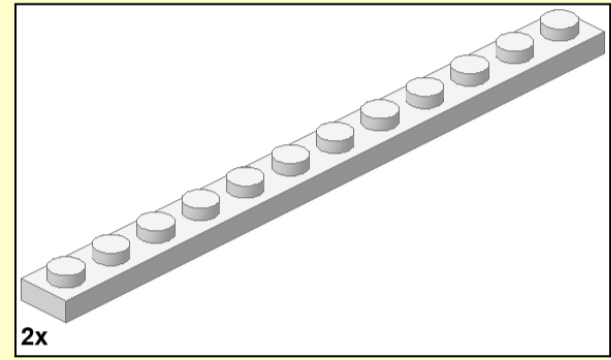

Instruction by Udilov Daniil

7

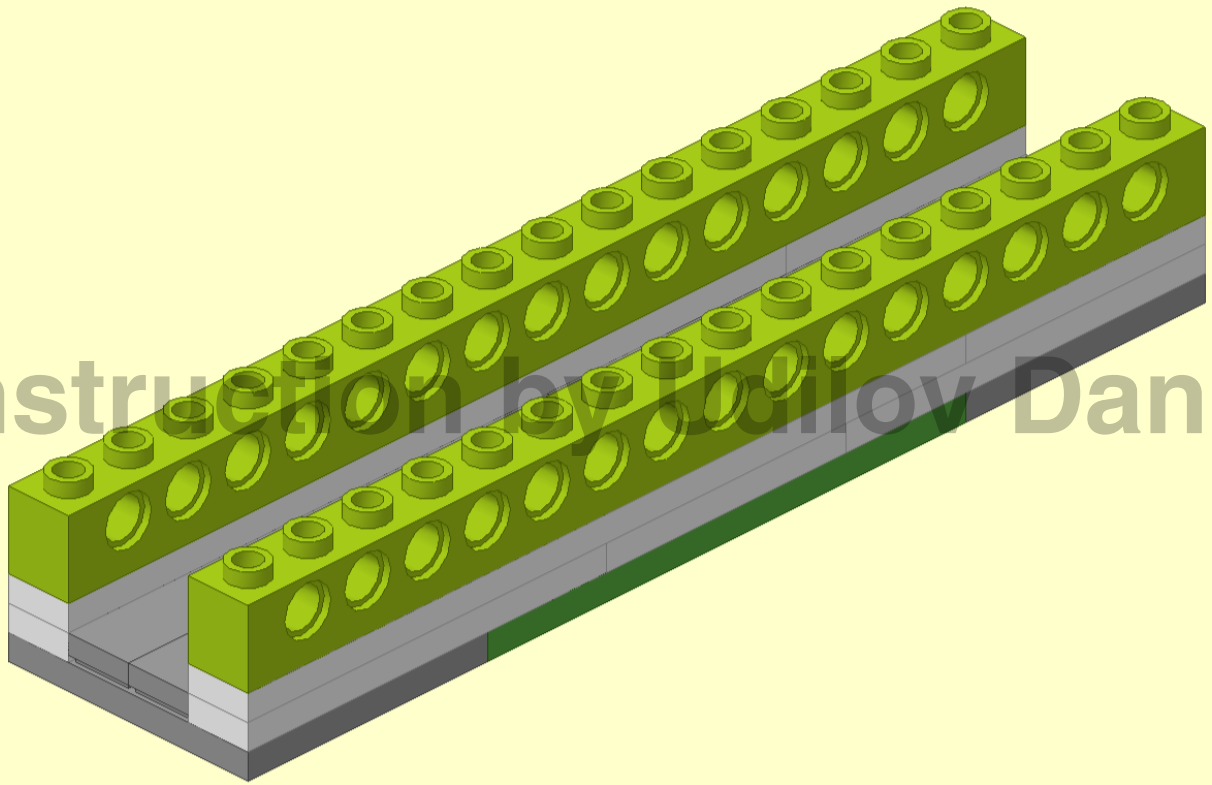
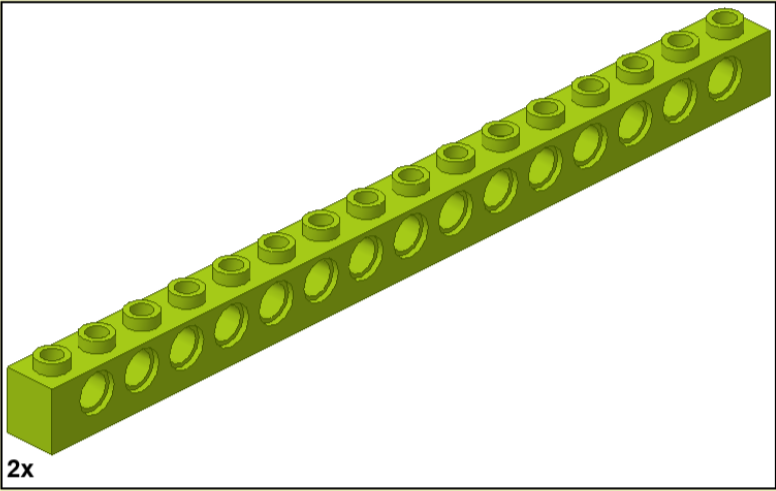

Instruction by Hollov Daniil

1

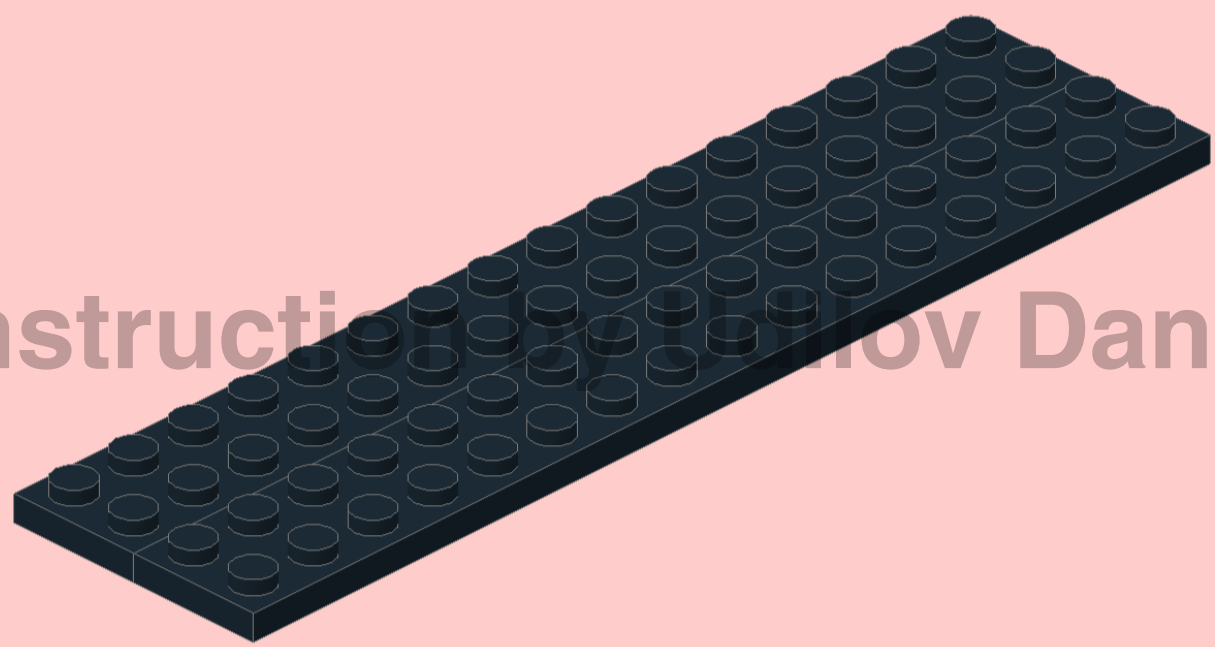
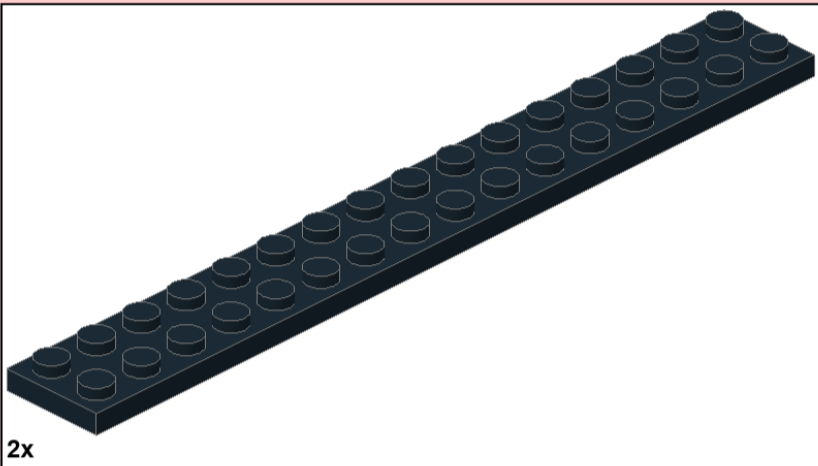

Instructional text: "Instruction" and "Nov Daniil" overlaid on the main image.

2

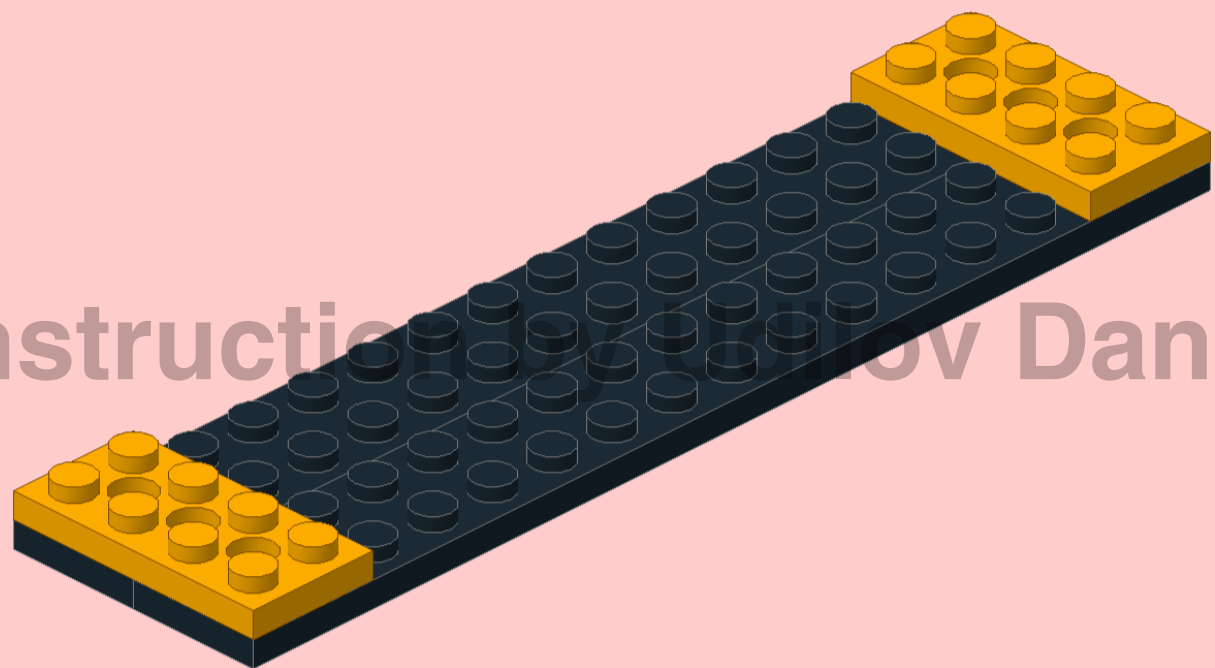
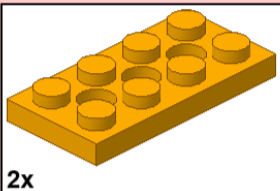

Instruction by Sergey Daniil

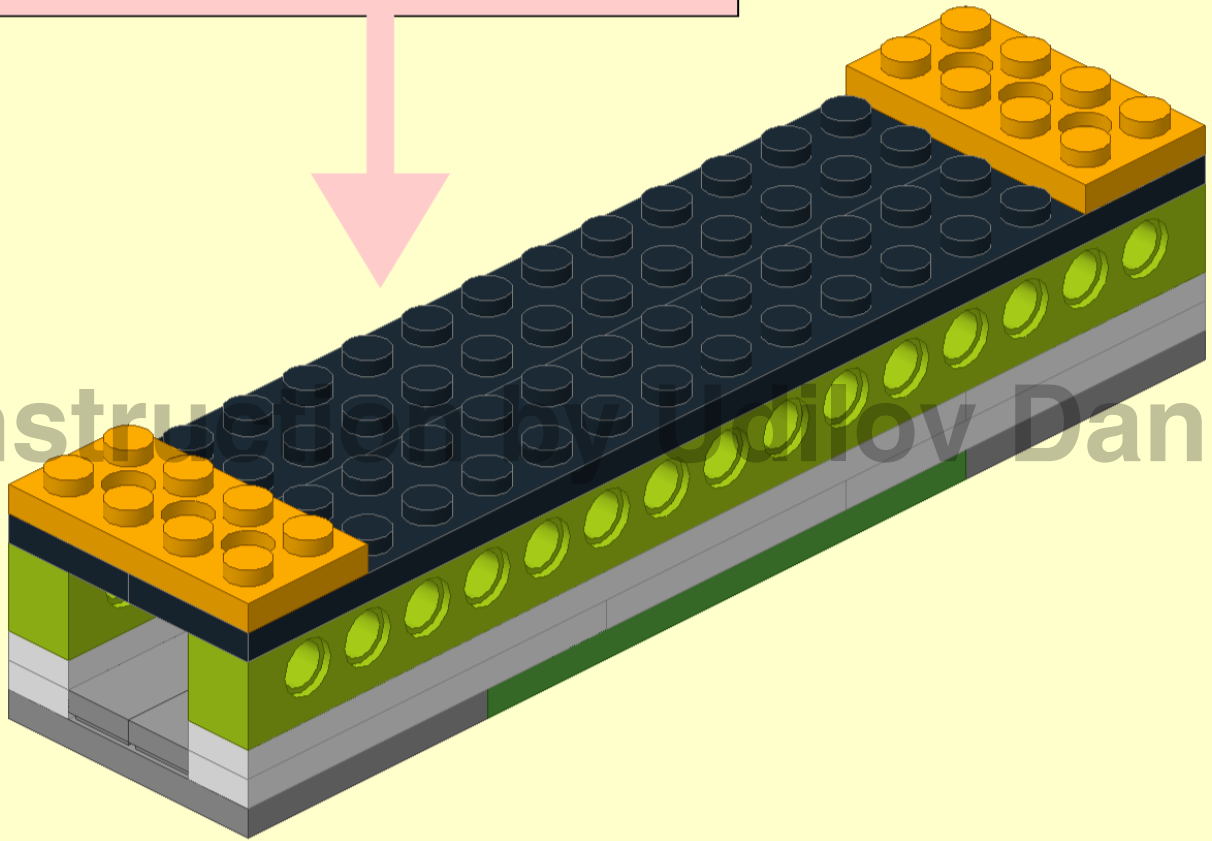
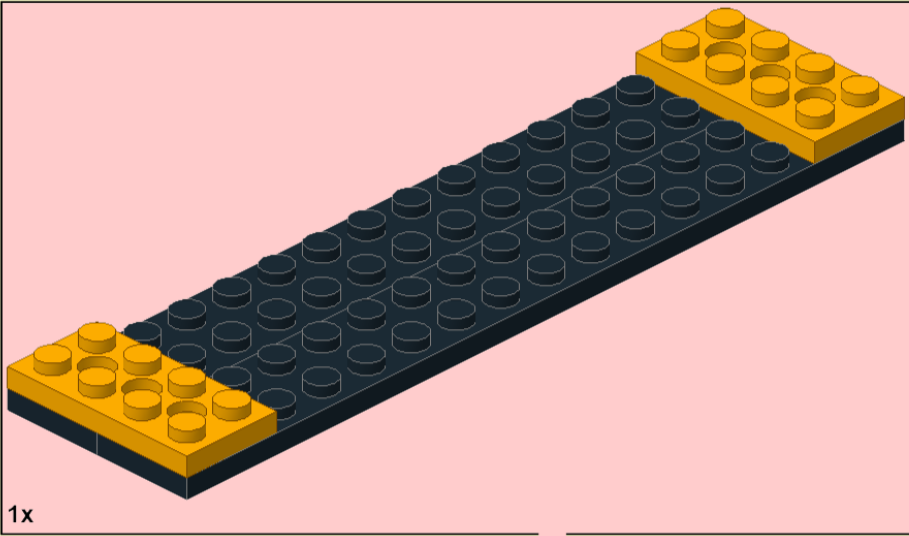

Instru...oy Daniil

10

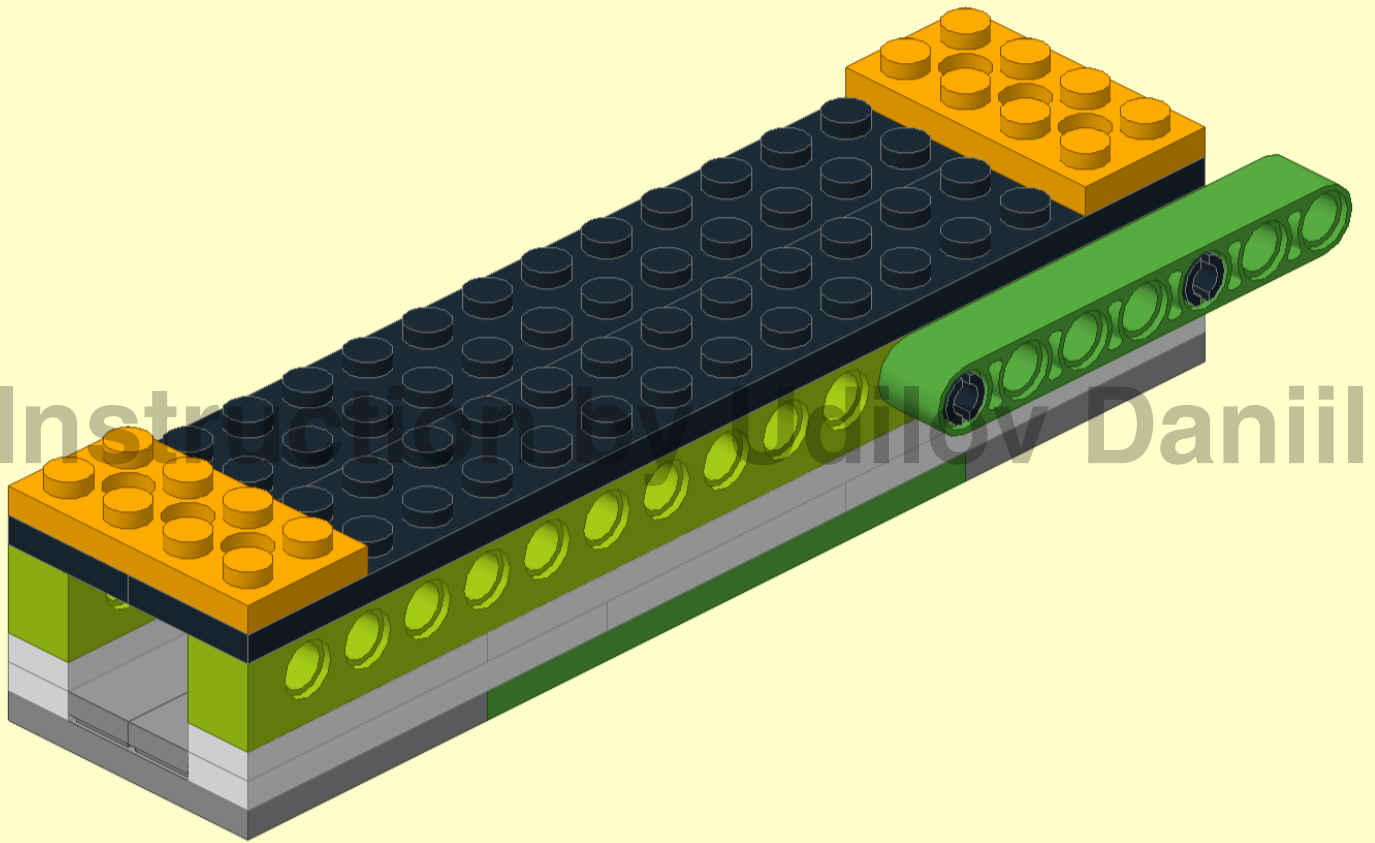
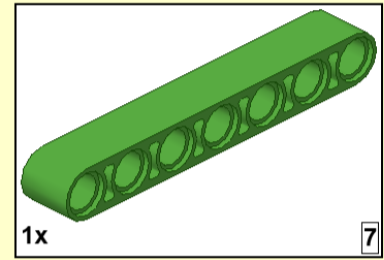

Instructions by Colley Daniil

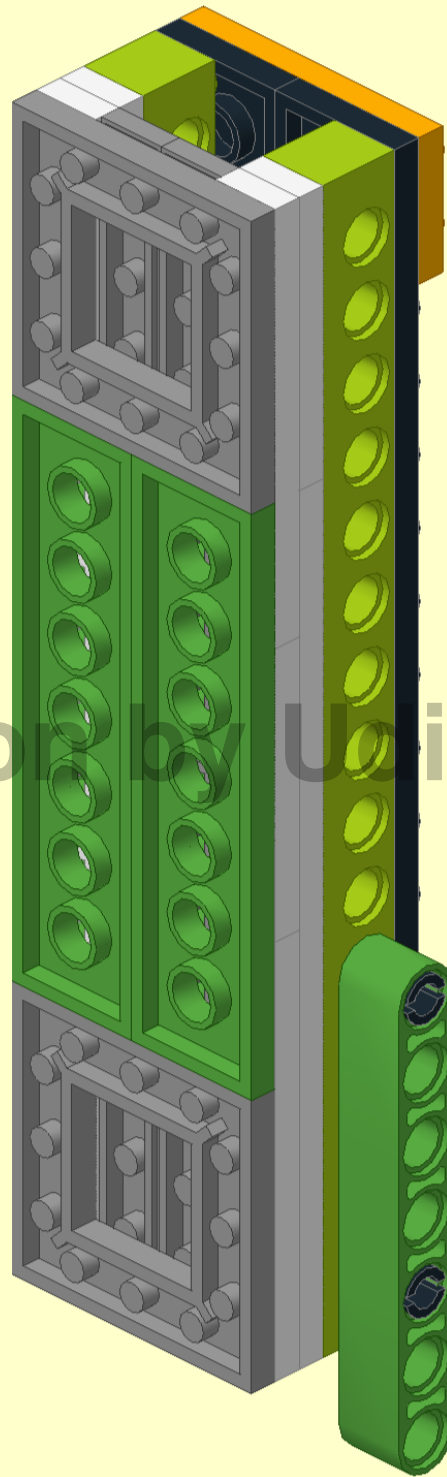

Instruction by Uvilov Daniil

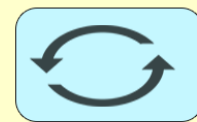

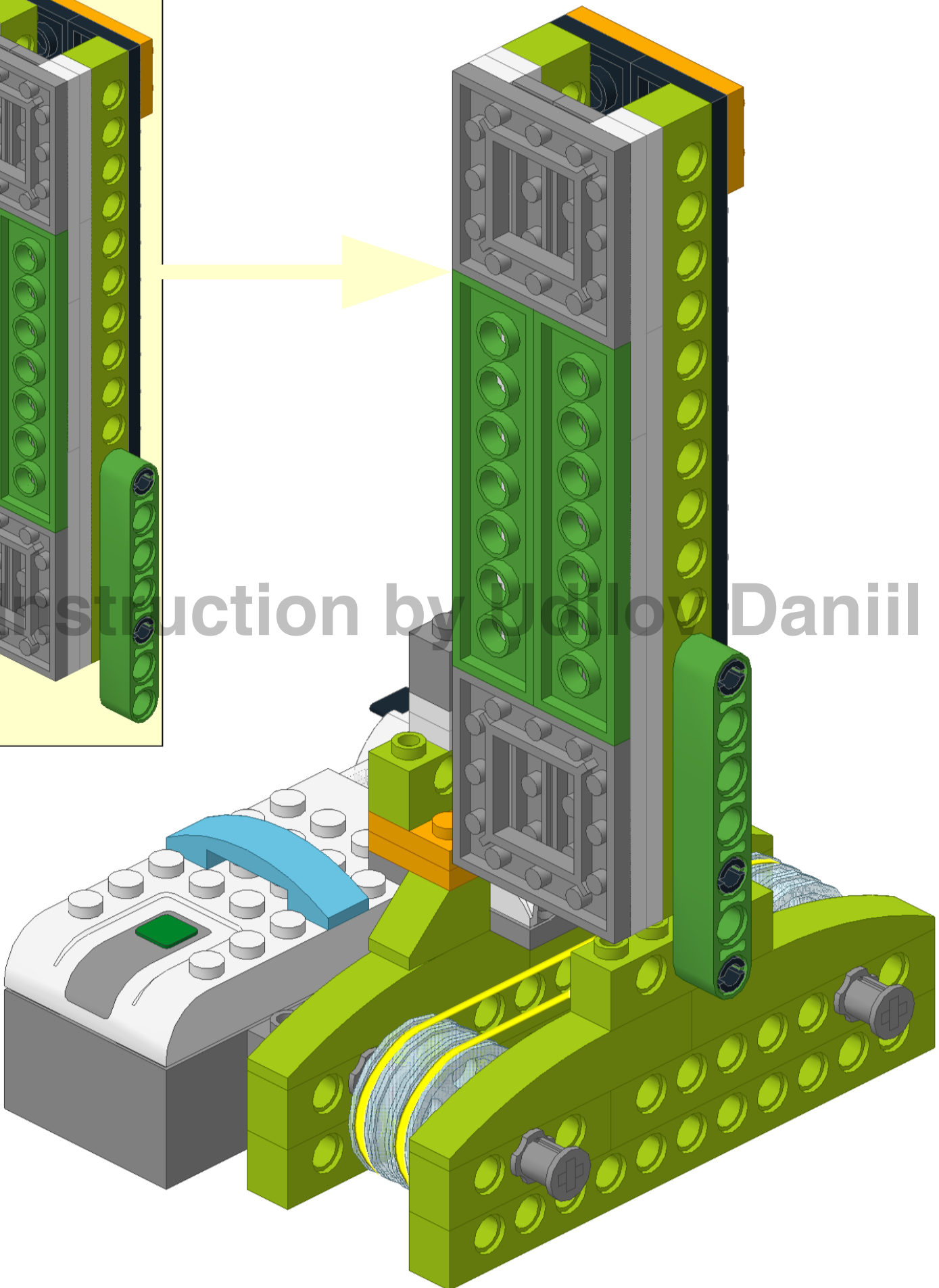
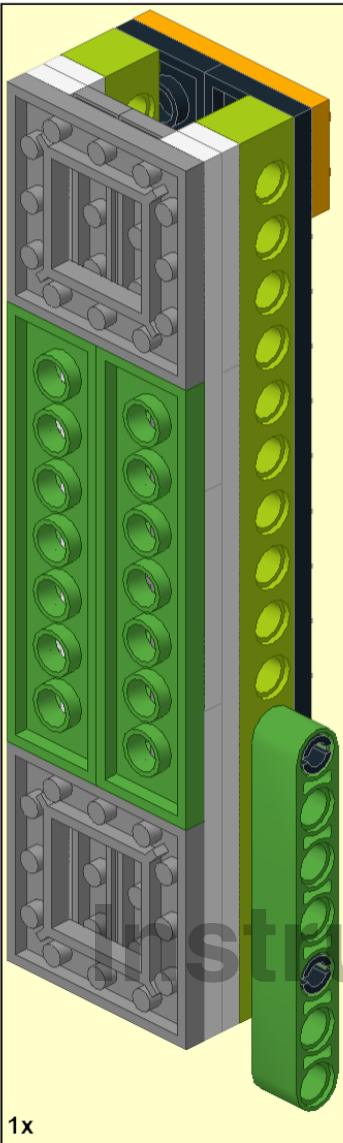

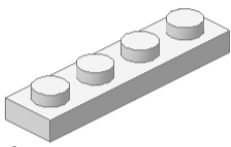

4x

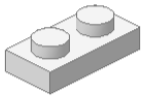

2x

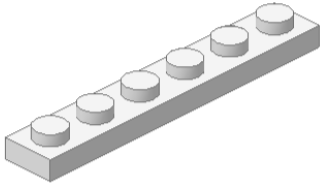

4x

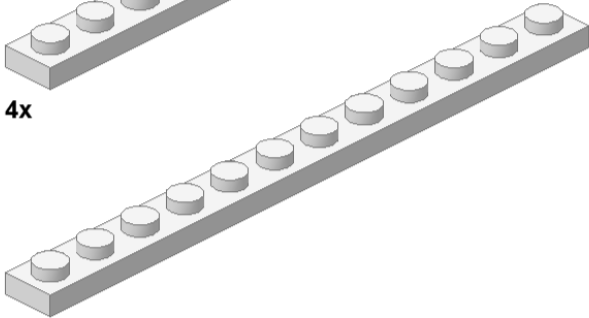

2x

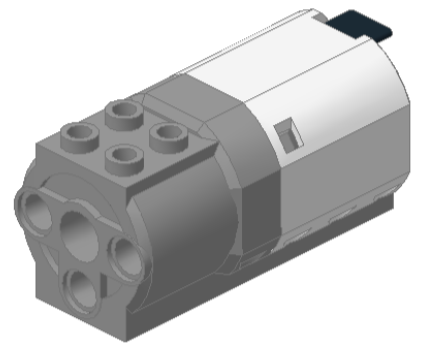

1x

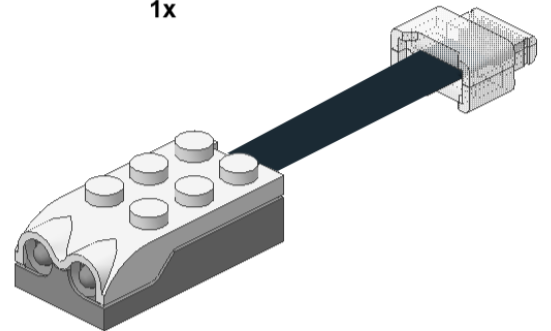

1x

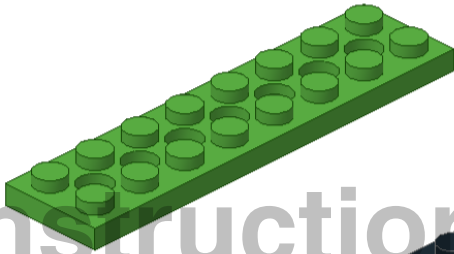

2x



2x

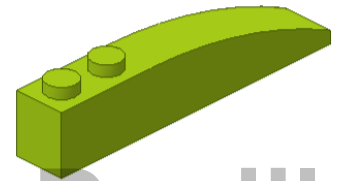

4x

Instruction by Udilov Daniil



8x



2x

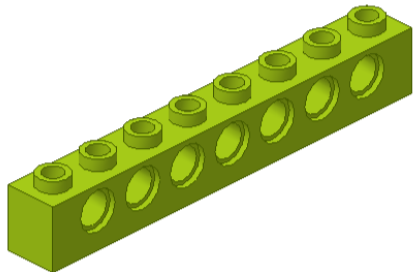

2x

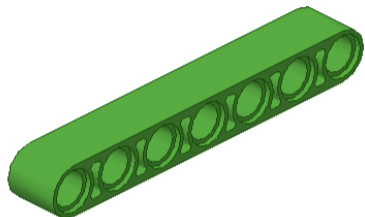

2x

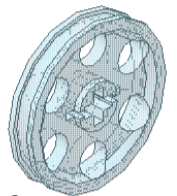

6x

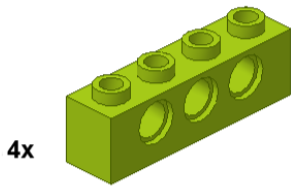
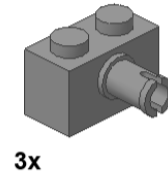
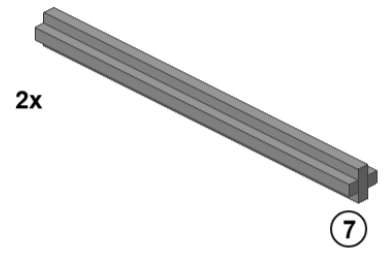
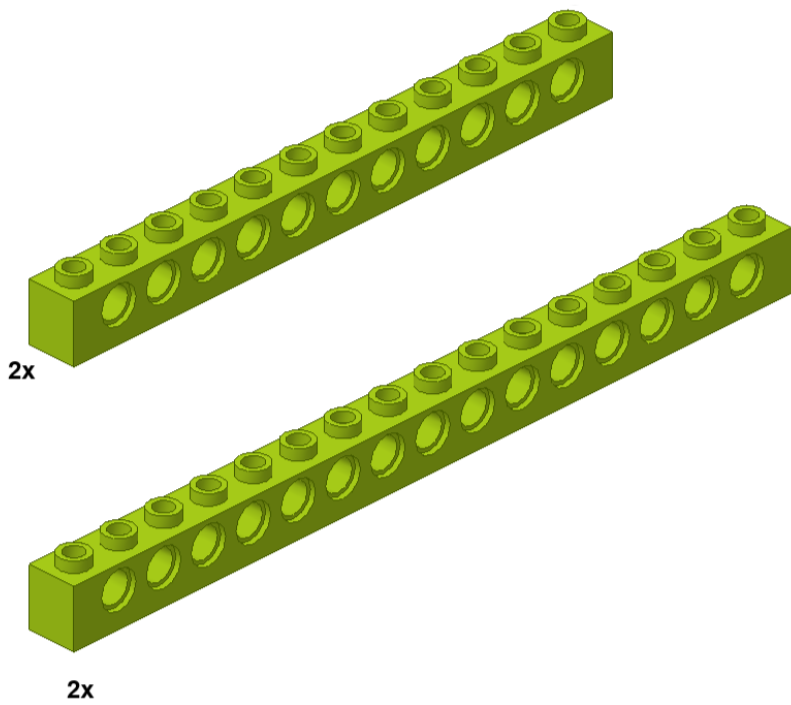

Instruction by Udilov Daniil

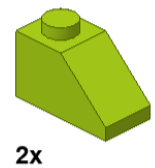
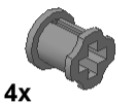
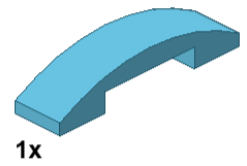
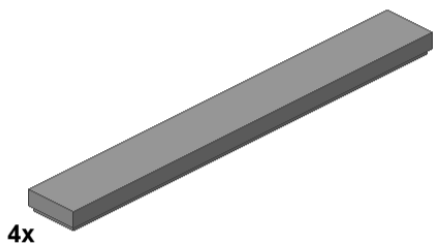
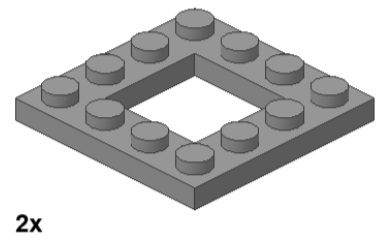
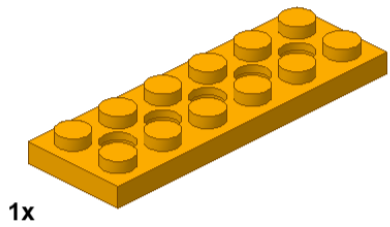
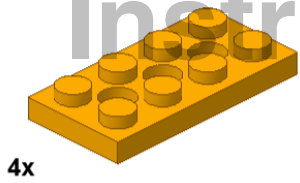

SORTER PROGRAM

Value determination from 0 to 10



Value of black color - move right



Value of white color - move left

