

1

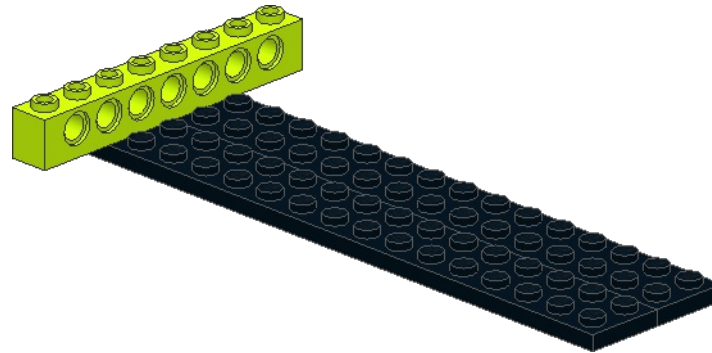

2

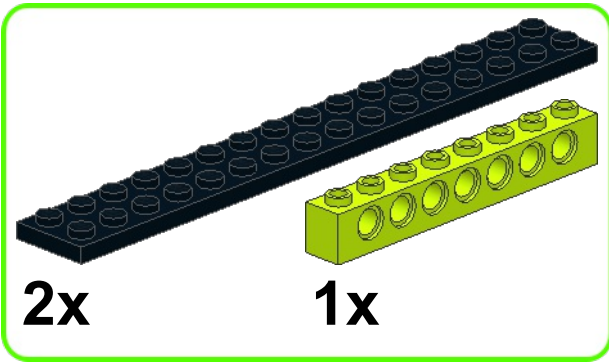
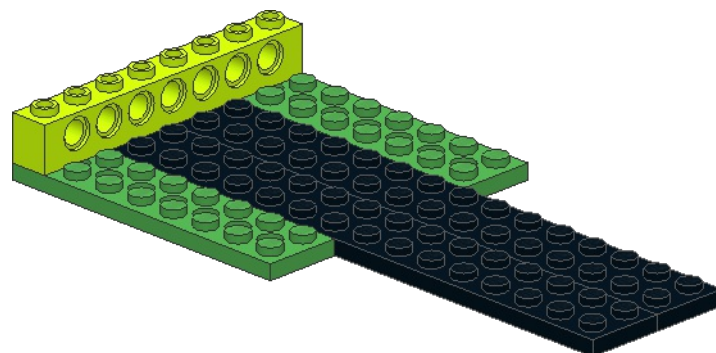
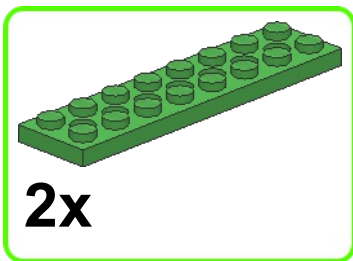

3

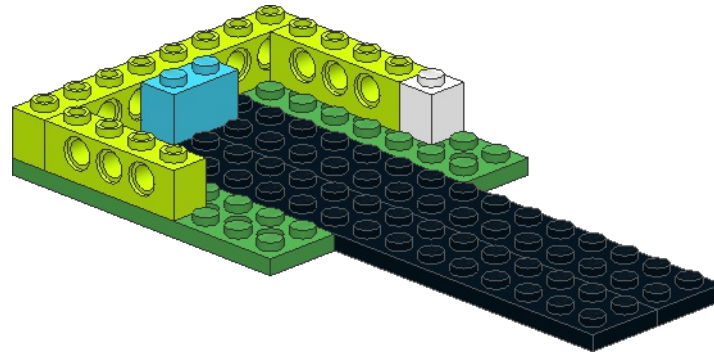
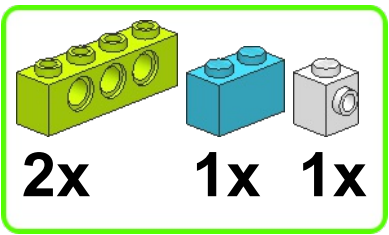

4

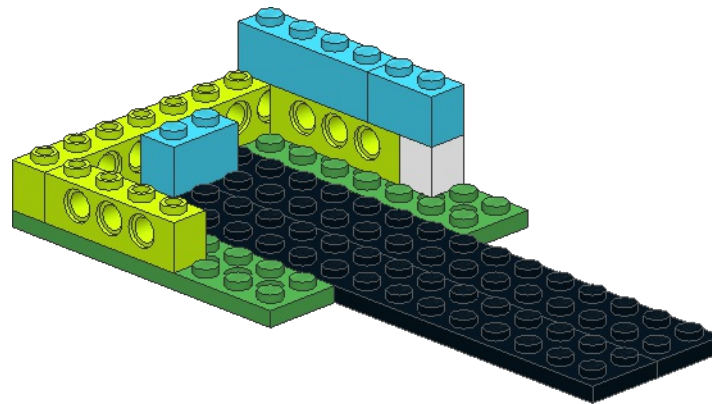
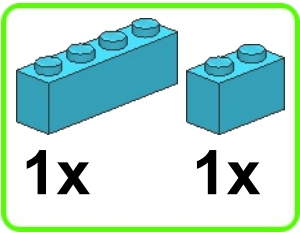

5

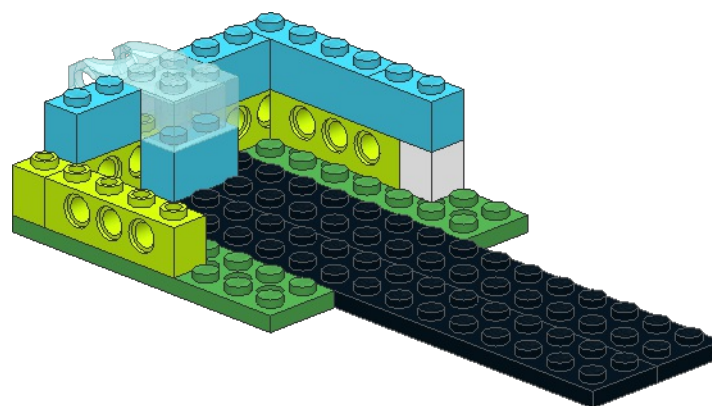
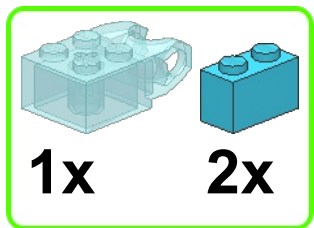

6

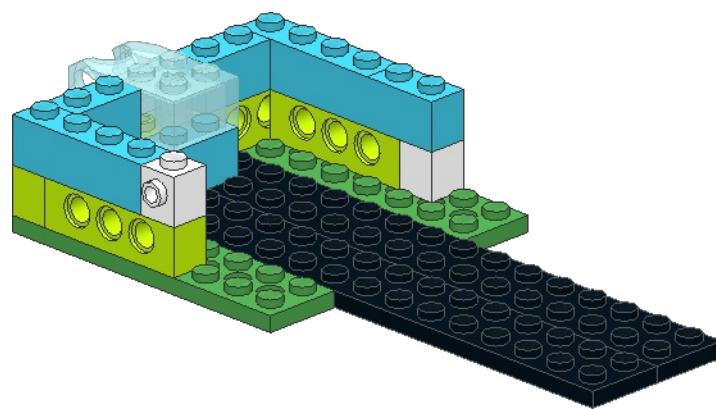
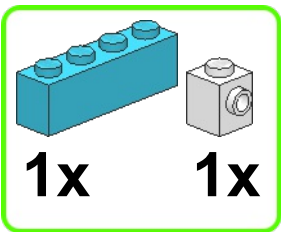

7

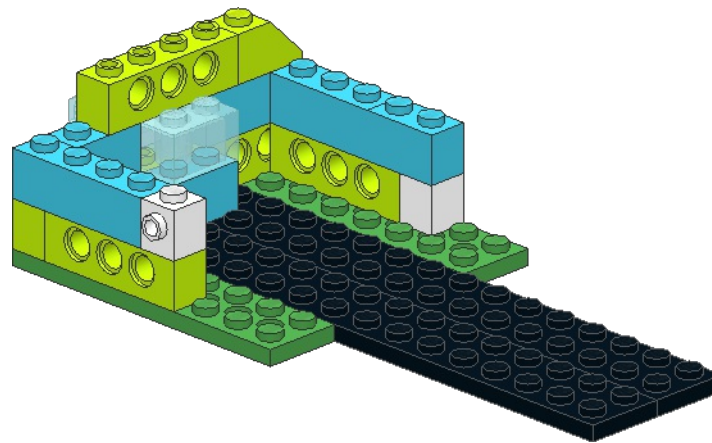
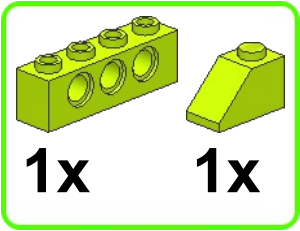



8

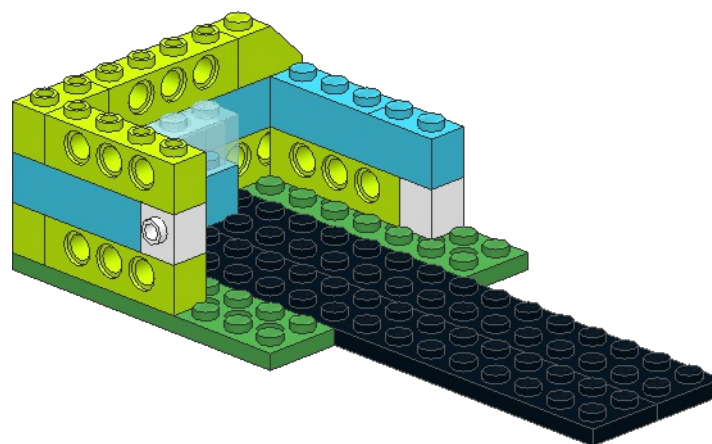
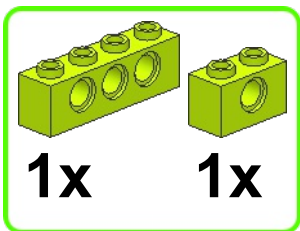

9

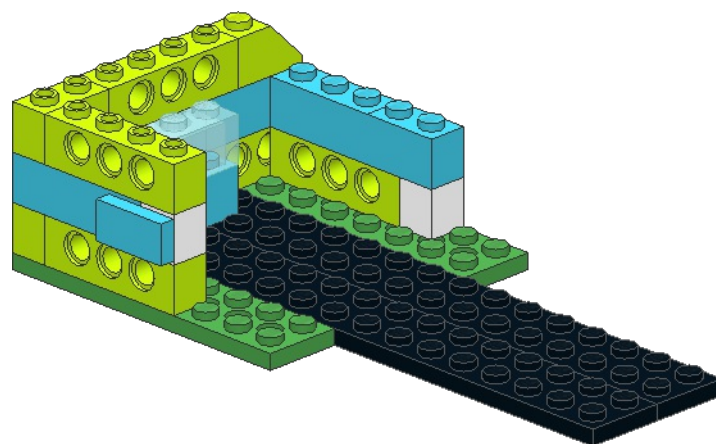
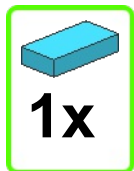

1



1x

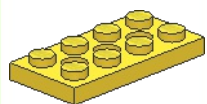

1x

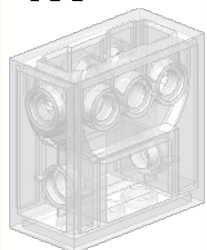

1x

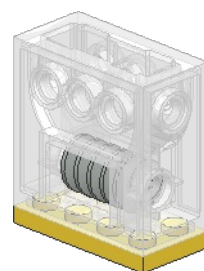

2

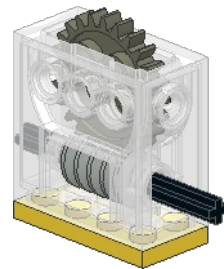
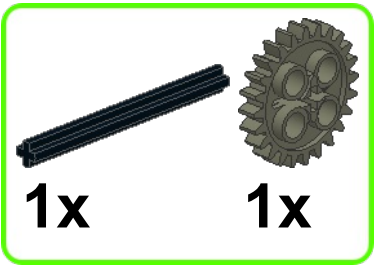

3

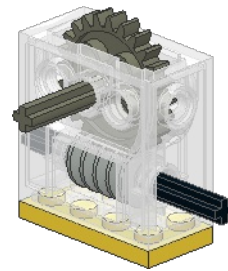

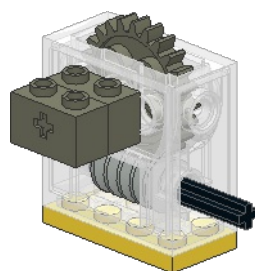
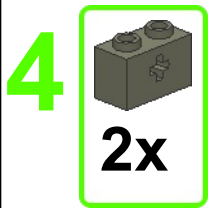

5

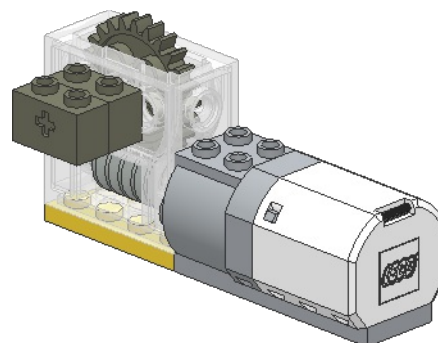
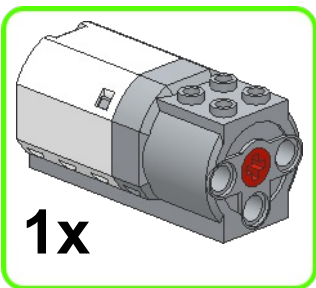

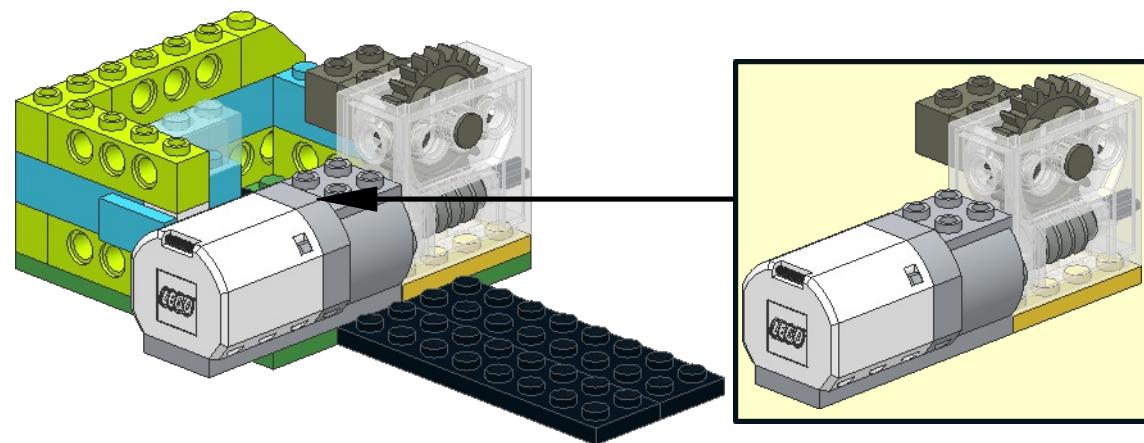



1

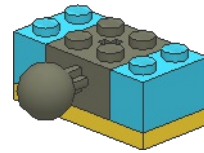
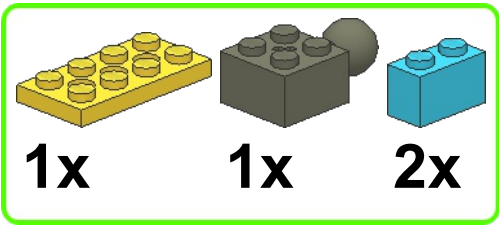

2

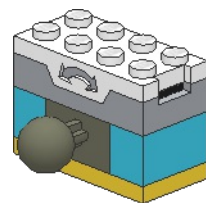
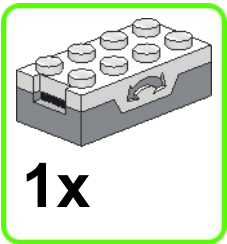

3

