

AQUA



612/612 *plus*

OWNERS MANUAL
AND
INSTALLATION INSTRUCTIONS

TROJAN TECHNOLOGIES INC.
845 Consortium Court
London, Ontario
N6E 2S8

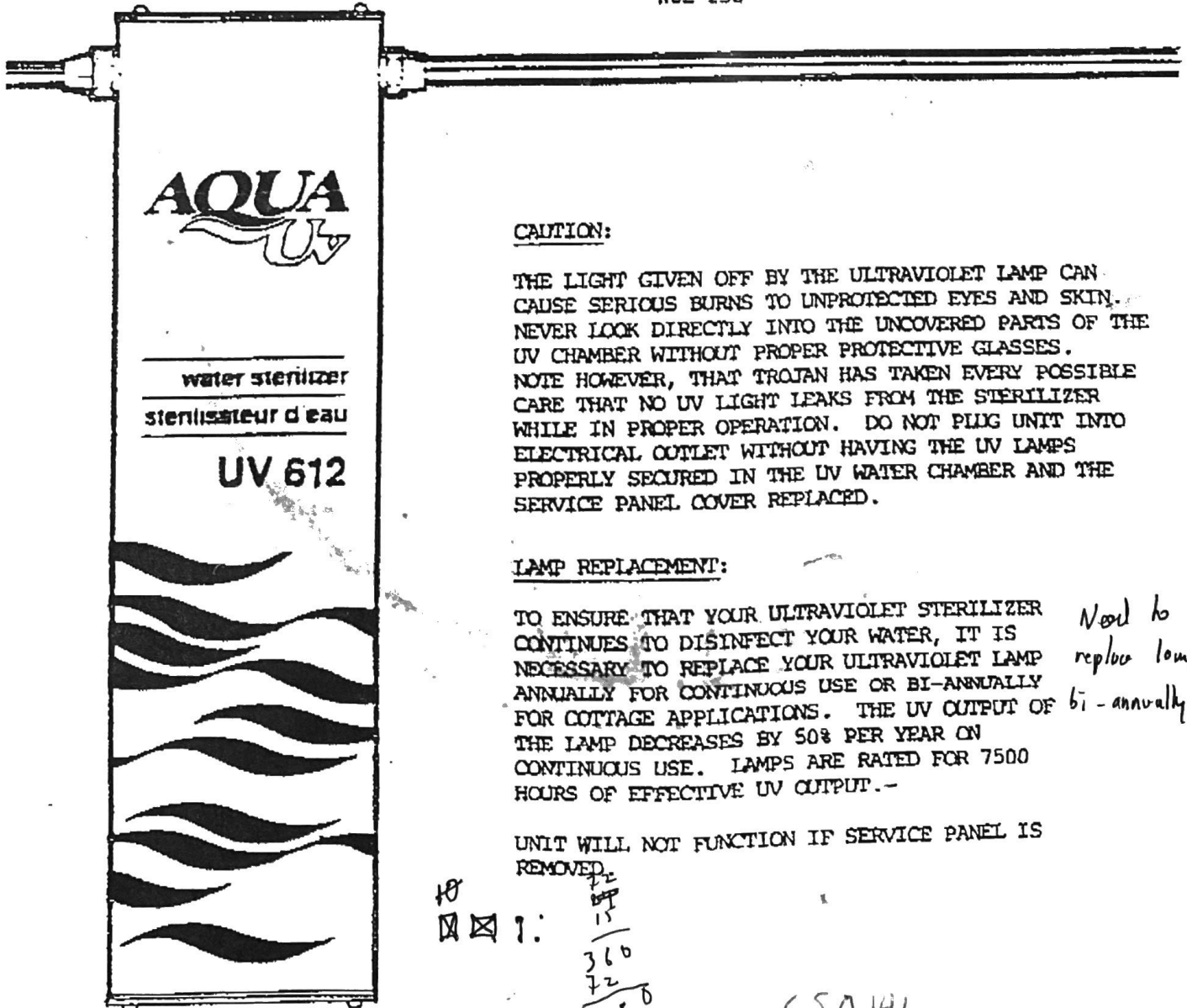

AQUA
UV

water sterilizer
sterilisateur d'eau

UV 612

CAUTION:

THE LIGHT GIVEN OFF BY THE ULTRAVIOLET LAMP CAN CAUSE SERIOUS BURNS TO UNPROTECTED EYES AND SKIN. NEVER LOOK DIRECTLY INTO THE UNCOVERED PARTS OF THE UV CHAMBER WITHOUT PROPER PROTECTIVE GLASSES. NOTE HOWEVER, THAT TROJAN HAS TAKEN EVERY POSSIBLE CARE THAT NO UV LIGHT LEAKS FROM THE STERILIZER WHILE IN PROPER OPERATION. DO NOT PLUG UNIT INTO ELECTRICAL OUTLET WITHOUT HAVING THE UV LAMPS PROPERLY SECURED IN THE UV WATER CHAMBER AND THE SERVICE PANEL COVER REPLACED.

LAMP REPLACEMENT:

TO ENSURE THAT YOUR ULTRAVIOLET STERILIZER CONTINUES TO DISINFECT YOUR WATER, IT IS NECESSARY TO REPLACE YOUR ULTRAVIOLET LAMP ANNUALLY FOR CONTINUOUS USE OR BI-ANNUALLY FOR COTTAGE APPLICATIONS. THE UV OUTPUT OF THE LAMP DECREASES BY 50% PER YEAR ON CONTINUOUS USE. LAMPS ARE RATED FOR 7500 HOURS OF EFFECTIVE UV OUTPUT.-

*Need to
replace lamps
bi-annually.*

UNIT WILL NOT FUNCTION IF SERVICE PANEL IS REMOVED.

10
11
15
360
72
10 8 0

650141

IMPORTANT NOTICE

To prevent the possibility of damage to the quartz sleeve and lamp in shipment, we have put a spring in the quartz sleeve.

If you install the sterilizer vertically with the inlet and outlet at the top, the spring should be removed. If the sterilizer is installed vertically with the inlet and outlet closest to the floor, or horizontally, the spring should be left in the unit for ease of lamp replacement.

UV612/UV612 PLUS ULTRAVIOLET WATER STERILIZER

INDEX

	<u>Page</u>
I. Introduction	1
II. UV612 basic sterilizer	2
III. UV612PLUS sterilizer	3
IV. Where to install your 612\612Plus sterilizer	4
V. Installing your 612\612Plus sterilizer	5
VI. Procedure for removing or replacing the UV lamp	6
VII. Procedure for removing or replacing the quartz sleeve	7
VIII. Procedure for cleaning the quartz sleeve	8
IX. Procedure for cleaning and removing the UV probe	9
X. Procedure for shocking the cold water pipelines	13
XI. Replacement parts	14
XII. Dimensions and specifications	15
XIII. Trojan Warranty	16

24 DEC 92 - REV#2

**UV612/UV612 PLUS
OWNERS MANUAL AND INSTALLATION INSTRUCTIONS
ULTRAVIOLET WATER STERILIZER**

IMPORTANT: Before proceeding with the installation of your equipment, read this manual and then retain it for reference in the future.

The Aqua UV612/UV612 Plus are sterilizers, not filters. It's only purpose is to destroy harmful bacteria and virus in your water supply. Preferably, a water filter with a sediment type cartridge with 15-30 micron rating and should be installed directly before the UV sterilizer. Failure to filter the water and remove sediment particles could limit effectiveness of your UV612/UV612 Plus ultraviolet sterilizer. An Activated Carbon filter will improve the effectiveness of your UV612/UV612 Plus ultraviolet sterilizer and the taste of your water. Note: water passed through the UV612/UV612 Plus sterilizer containing iron or filterable solids will require cleaning of the quartz sleeve periodically.

UV 612

The UV612 water sterilizer maintains your water supply free of bacteria, viruses, algae and fungi through irradiation of the water with ultraviolet light; an efficient and economical disinfecting agent which will disinfect your water without any chemical additives, therefore your water tastes natural.

These features make your UV612 a dependable unit that is easy to maintain:

- Quartz sleeve surrounding the ultraviolet source to ensure efficient operation at low water temperatures.
- Large 12 (U.S) gallons/45 litres per minute capacity to treat the whole house.
- Easy lamp replacement, no water shut down required for lamp replacement.
- Simple installation with basic household tools.
- Long lasting stainless steel water chamber.
- No chip, no rust anodized aluminum case.
- Easily removable quartz sleeve for cleaning if necessary.
- Audio alarm and LED indicators to advise you of premature lamp failure.
- Safety cut-off switch to prevent accidental exposure to UV when service panel is removed.

WARNING: THE LIGHT GIVEN OFF BY THE ULTRAVIOLET LAMP CAN CAUSE SERIOUS BURNS TO UNPROTECTED EYES AND SKIN. NEVER LOOK DIRECTLY INTO THE UNCOVERED PARTS OF THE UV CHAMBER WITHOUT PROPER PROTECTIVE GLASSES. NOTE HOWEVER, THAT TROJAN HAS TAKEN EVERY POSSIBLE CARE THAT NO UV LIGHT LEAKS FROM THE STERILIZER WHILE IN PROPER OPERATION. DO NOT PLUG UNIT INTO ELECTRICAL OUTLET WITHOUT HAVING THE UV LAMPS PROPERLY SECURED IN THE UV WATER CHAMBER AND THE SERVICE PANEL COVER REPLACED.

UV612 PLUS

Congratulations in choosing the UV612 Plus for your water disinfection. This unit offers all the features found in the basic UV612, but with the addition of "around the clock monitoring".

These are the additional features provided by your UV612 Plus:

- UV intensity meter with L.E.D bar graph display
- Low intensity audio alarm
- Output for an optional remote audio alarm
- External A/C plug to power an optional normally closed solenoid shut off valve

How it works:

An ultraviolet detector senses the amount of ultraviolet light transmitted from the lamp through 1 cm of water, and turns it into a small electrical current which is successively amplified to operate a visual display, audio alarms, etc.

Note that the intensity reading on the bar graph is affected by:

1. The output of the lamp.
2. The amount of UV energy transmittance through the water.
3. The amount of UV energy transmittance through the quartz sleeve to the probe.

The L.E.D bar graph display consists of a vertical array of 7 red lights. The first one at the bottom when installed vertically with the inlet and outlet at the top, simply indicates that the power is "ON", the second one - up to the seventh are an indication of the amount of UV passing through the water. When the intensity drops to the point that the second (from the bottom) L.E.D stops glowing, this means that the quartz sleeve and UV probe need cleaning (refer to the manual) or, if this doesn't help, the lamp output is no longer sufficient to provide proper disinfection. A new lamp will be required for proper disinfection.

WHERE TO INSTALL YOUR UV612/UV612 PLUS STERILIZER

- a) Your UV612/UV612 Plus should always be installed after the pressure tank or water meter and after all filtration and/or other water treatment equipment just prior to the line split for your hot and cold water.

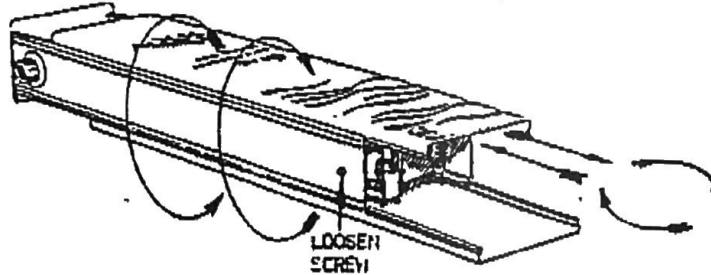

Typical installations of the UV612/UV612 Plus in most houses is:

"Between the Rafters" or "Wall Mounted", however in order to improve versatility, the front and back panels are reversible and interchangeable. This can be accomplished by removing the service panel and loosening the two screws, located one on each side of the sterilizer, closest to the service panel.

The unit can be installed in the following positions:

- a) Vertical with the inlet and outlet at the top. Inlet is on the plain side. The outlet is on the power cord side (recommended).
- b) Vertical with inlet and outlet at the bottom. The inlet is on the power cord side. The outlet is on the plain side.
- c) If the unit is installed in the horizontal position, the water must enter the unit through the lower water line connection. The inlet is on the plain side and the outlet is on the power cord side.

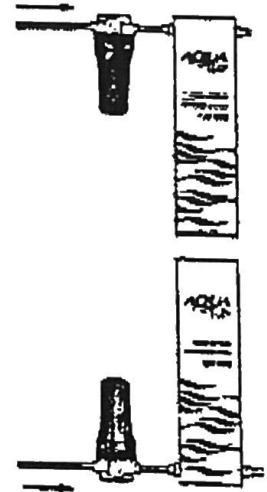

NOTE: It is not recommended that this unit be installed in any other positions.

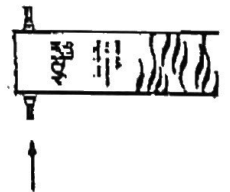

- Other requirements:
- a) Access to electrical outlet
 - b) 38" of clearance in front of the service panel (for maintenance and servicing).

INSTALLING YOUR UV612/UV612 PLUS STERILIZER

Once the location for the sterilizer has been selected and allowing 38" clearance for lamp removal, follow procedure A or B depending on the type on installation.

NOTE: The Trojan UV614 Quick Connector Kit is included for easy installation.

Procedure A: Between Rafters Installation

1. Support water line with pipe straps fastened to the rafters closest to where the sterilizer will be installed.

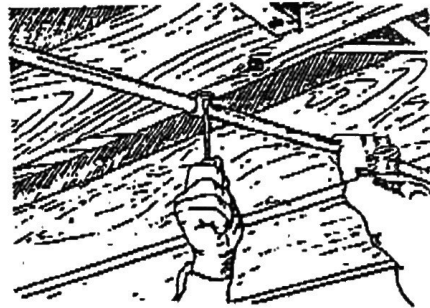

2. Shut off the water supply and drain lines.

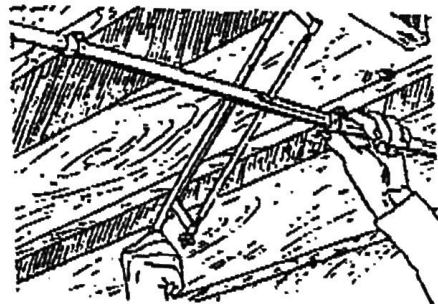

3. Cut a 7 1/2" segment out of the line where the sterilizer will be mounted.

NOTE: If a hacksaw is used to cut the pipe, burrs will have to be removed with the help of steel wool or sand paper.

4. Slip quick connectors (UV614) on each end of the pipe as shown.

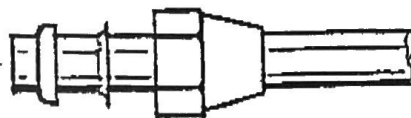
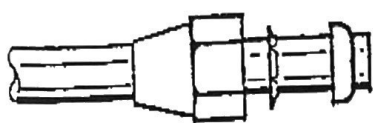

5. Position the sterilizer and tighten connectors.

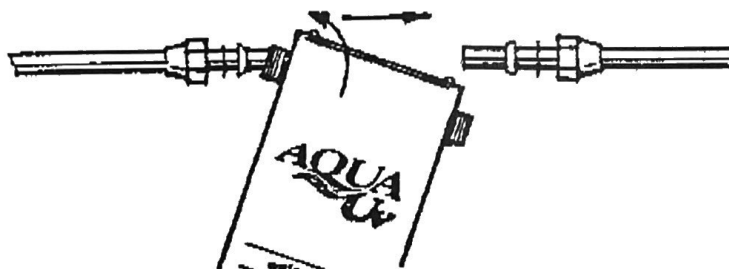

Procedure B: Wall Installation

1. Shut off water supply and drain lines.
2. Make sure water line can be lifted 1 3/4" from the wall.
- 3&4 Steps are the same as per "Between Rafter Installation".

5. Remove service panel and front panel of UV612/UV612 Plus to access the two mounting holes located at the top & bottom of the rear panel.

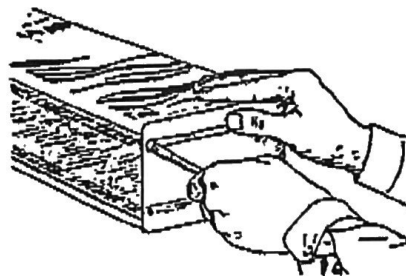

6. Place the sterilizer temporarily in the proper position, and mark the spots where the holes are to be drilled into the wall.

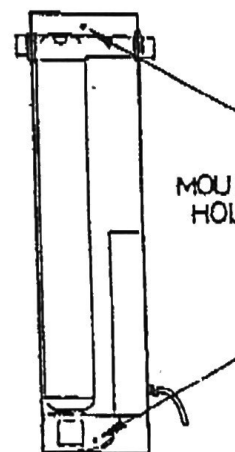
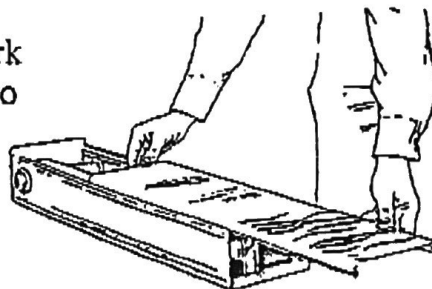

7. Remove sterilizer, drill holes and place anchors.

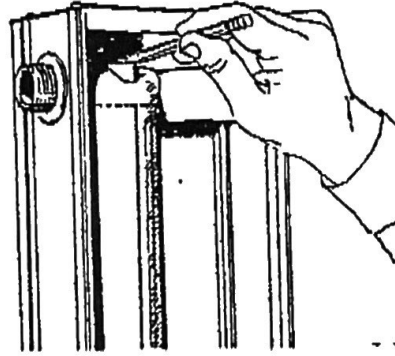

8. Put UV612/UV612 Plus back and fasten to the wall.

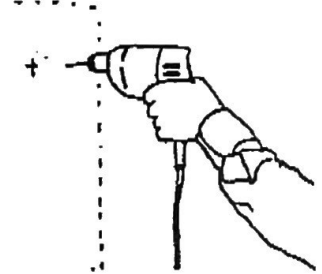

9. Tighten connectors.

10. Replace front panel and service panel.

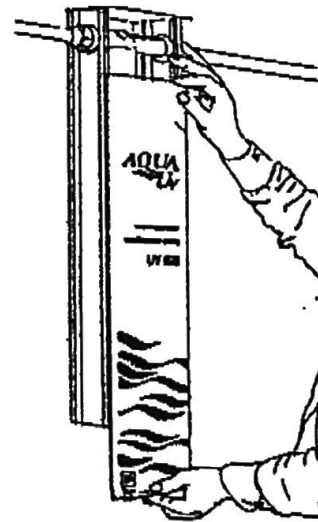

You should test the sterilizer at this point by plugging the sterilizer into your electrical outlet. Within a few seconds, the red monitor light on the side of the UV612 unit will start to glow steadily, the UV612 Plus bar graph will read full output - all 7 L.E.D's will come on.

After checking connections to ensure they are secure, turn water on and check for leaks. If all connections are water tight, plug in the sterilizer and wait for the red monitor light to glow steadily on the UV612 or the power indicator on the UV612 Plus.

Your sterilizer is now ready for use. Run water through the system by opening a tap for three or four minutes to clear any dirt and air.

WARNING: WHEN THE STERILIZER IS CONNECTED USING THE (UV614) CONNECTOR KIT, AN INTERRUPTION IN THE ELECTRICAL GROUND THROUGH THE PLUMBING LINE MAY OCCUR. THIS CAN EASILY BE REMEDIED BY RE-ROUTING THE GROUND CONNECTION TO A POSITION BEFORE THE STERILIZER, CHECK WITH LOCAL ELECTRICAL AUTHORITIES FOR PROPER WIRING.

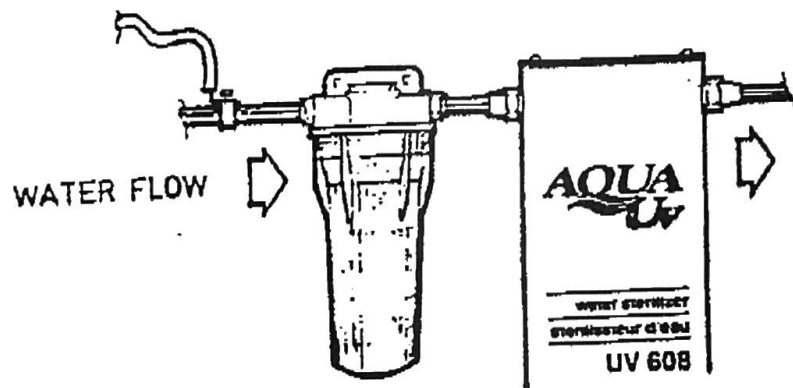

NO SOLDERING SHOULD BE DONE TO THE PIPES CLOSE TO THE STERILIZER AS THE HEAT COULD DAMAGE PLASTIC CONNECTORS, AND INTERNAL SEALS.

THE LIGHT GIVEN OFF BY THE ULTRAVIOLET LAMP CAN CAUSE SERIOUS BURNS TO UNPROTECTED EYES AND SKIN. NEVER LOOK DIRECTLY INTO THE UNCOVERED PARTS OF THE UV CHAMBER WITHOUT PROPER PROTECTIVE GLASSES. DO NOT PLUG UNIT INTO ELECTRICAL OUTLET WITHOUT HAVING THE UV LAMPS PROPERLY SECURED IN THE UV WATER CHAMBER AND THE BOX CLOSED.

PROCEDURES FOR REPLACEMENT OF THE ULTRAVIOLET LAMP

Replace Lamp Annually for proper UV disinfection.

Tools required: Narrowed-tip flat head and Phillips screwdriver

Step 1: Unplug sterilizer.

Step 2: Remove the service panel by unscrewing the 4 retaining screws.

Step 3: Remove the lamp holder in the sleeve bolt (black plastic knob at the bottom of the UV cell) by inserting a narrowed tip screw-driver into one of the slots at the side of the bolt and by applying pressure to the underside of the lamp socket, pry it out carefully.

Step 4: Carefully ease out the lamp socket with the lamp attached, unplug the socket and pull lamp out.

Step 5: Remove the new lamp from the packaging carefully handling it by the ends. Avoid touching lamp glass with fingers, as skin oils will prevent proper UV radiation. If skin contact occurs, wipe lamp off with alcohol.

Step 6: Insert new lamp into the sterilizer vessel.

Step 7: Plug lamp into the socket.

Step 8: Push lamp back in its original position, and press the lamp socket back in the sleeve bolt.

Step 9: Replace service panel and fasten with the 4 screws. (Unit will not function until the service panel is replaced)

Step 10: Plug in the sterilizer and check monitor light for a steady red glow on the UV612 and the power indicator to come on for the UV612 Plus.

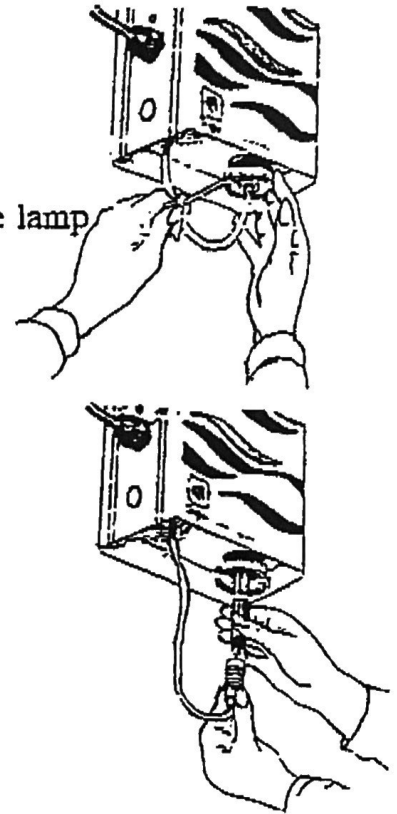

PROCEDURE FOR REMOVING OR REPLACING THE QUARTZ SLEEVE

- Step 1: Shut off water supply and drain the water lines by opening taps.
- Step 2: Follow steps 1 through 4 in "Procedure for Replacing UV Lamps".
- Step 3: If the unit is mounted upright, place a pail under it to collect the water draining from the UV chamber when opened.
- Step 4: Using the wrench provided, unscrew sleeve bolt and carefully extract the quartz sleeve and o-ring from the UV chamber.

NOTE: In many cases after the sterilizer has been in use for some time, the o-ring will tend to adhere to the quartz sleeve. This presents no problem if it is left alone, however, if it is removed from the sleeve, a new replacement o-ring is strongly recommended, as the surface of the old o-ring could be damaged during the removal, and be the cause of leakage.

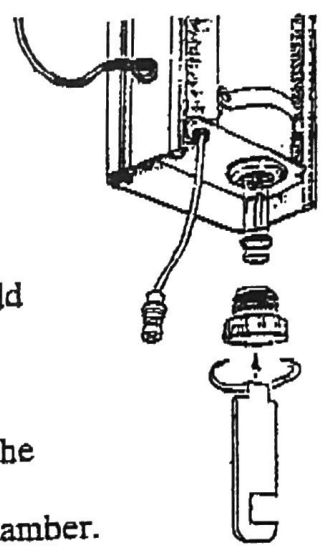

- Step 5: Re-assemble the sleeve, making sure the closed end of the sleeve is properly positioned in the centre of the UV chamber.

NOTE: IN CASES WHERE THE O-RING WAS REMOVED FROM THE SLEEVE, RE-INSERT THE REPLACEMENT AND POSITION IT ABOUT 3/4" FROM THE OPEN SLEEVE END.

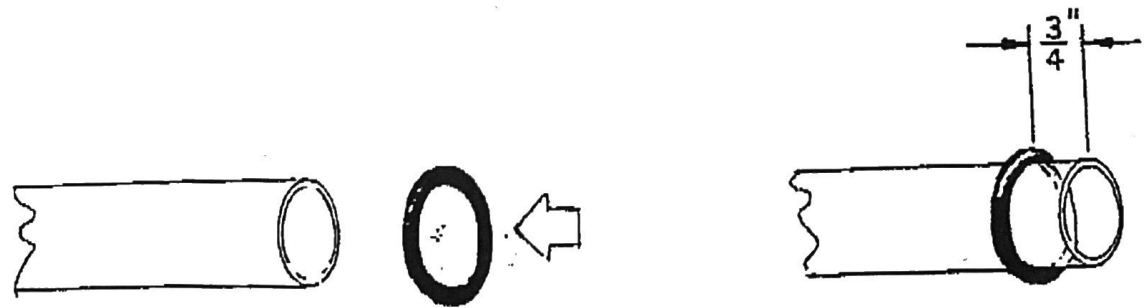

continue...

- Step 6: Re-assemble the sleeve bolt and tighten it up with the wrench provided.
- Step 7: Open the water taps and turn the water on. Check for leaks around and inside the sleeve bolt.
- Step 8: Re-assemble lamp and socket.
- Step 9: Re-assemble the service panel, plug in the electrical connector and check for a steady glow of the L.E.D light or the power indication on the bar graph.

PROCEDURE FOR CLEANING THE QUARTZ SLEEVE.

- Step 1: Follow steps 1 through 4 in "Procedure for Removing and replacing the quartz sleeve".
- Step 2: Clean the quartz sleeve by wiping with cloth soaked in a mild acidic solution such as vinegar or citric acid (recommend a product called "Lime Away").
- Step 3: Follow steps 5 through 9 in "Procedure for removing and replacing the quartz sleeve".

PROCEDURE FOR CLEANING AND REMOVING THE UV PROBE

NOTE: IF YOUR UNIT IS A 612 PLUS THE PROBE SHOULD BE CLEANED EVERY TIME THE QUARTZ SLEEVE IS CLEANED.

Step 1: Follow steps 1 through 5 in "Procedure for Removing and replacing the quartz sleeve".

Step 2: The UV probe is located on the side of the UV chamber and is accessible by removing service panel and sliding out the front panel (loosen one screw on each lower side of the side panels).

Step 3: Disconnect the white connector to prevent the wires from being twisted.

Step 4: Unscrew the probe from the chamber taking care not to lose the small o-ring.

Step 5: Clean the probe in the same manner as the sleeve. Avoid touching the light pipe on probe with fingers.

Step 6: To re-assemble, place the o-ring around the quartz rod, and then screw the probe back in its place. Tighten the probe snugly.

Step 7: Plug in the white connector.

Step 8: Follow steps 6 through 9 in "Procedure for removing and replacing the quartz sleeve".

Step 9: Re-install front panel and service panel and tighten screws.

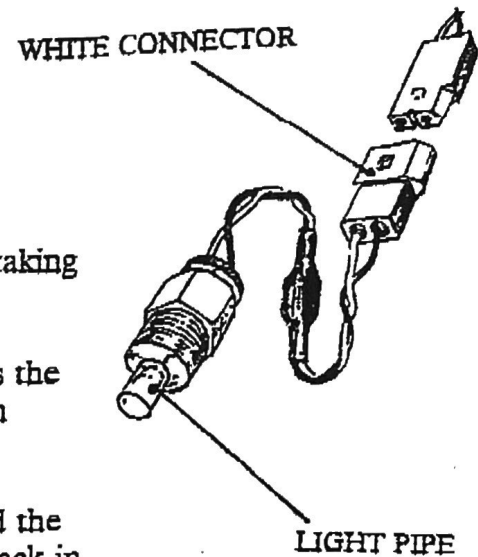

PROCEDURE FOR SHOCKING THE WATER LINES

- Step 1: Shut off water supply and drain the water lines by opening a tap.
- Step 2: Shock the system and the pipelines with bleach or chlorine. If you have a pre-filter, remove the filter from the filter sump and pour one cup of solution into the filter sump.
- Step 3: Replace the filter sump and tighten.
- Step 4: Open water supply and run water to all taps one at a time until you smell the bleach or chlorine at the taps.
- Step 5: Let the solution remain in the water lines for a minimum of two hours.
- Step 6: Flush the water lines until the smell of chlorine or bleach is no longer detected.
- Step 7: Shut off water supply and drain the water lines by opening a tap.
- Step 8: Replace filter into filter sump and tighten.
- Step 9: Turn on your water supply as your system is ready for use.

UV612/UV612 PLUS STERILIZERS

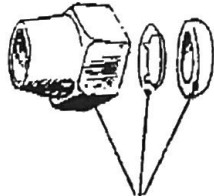

UV614
CONNECTOR KIT

UV689 WRENCH

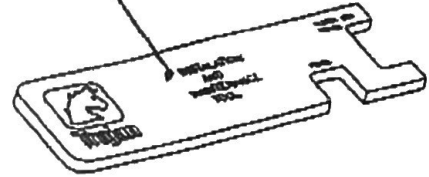

UV542 O-RING
OUTER PROBE

UV386 DETECTION PROBE
(Plus units only)

UV029 120V 60Hz BALLAST
UV212 220V 50Hz BALLAST

UV3614 LAMP

UV661 SLEEVE

UV645 LED BOARD
UV688 DETECTION BOARD
(Plus units only)

UV641 MICRO SWITCH

UV666 SLEEVE BOLT

UV082 O-RING

UV642 LAMP SOCKET

DIMENSIONS AND SPECIFICATIONS

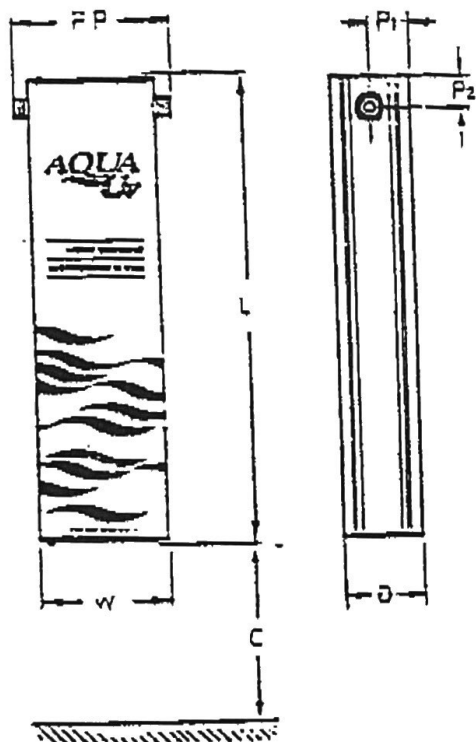

DIMENSIONS

L	=	38 1/2"	—	(98	cm)
W	=	6 3/4"	—	(17.2	cm)
D	=	4 1/2"	—	(11.5	cm)
PP	=	8 1/2"	—	(21.6	cm)
P1	=	2 1/4"	—	(5.8	cm)
P2	=	2"	—	(5.0	cm)
C	=	38"	—	(96	cm)

SPECIFICATIONS

Electrical:	120V/60Hz/50W 220V/50Hz/50W
Ambient Temperature:	36 - 104 Degrees F. 2 - 40 degrees C.
Maximum Recommended Flow:	12.0 U.S. GPM. 45 L/min.
Maximum Operating Pressure:	125 PSI (9 bar)
Pressure Drop at Rated flow:	3 PSI (0.2 bar)
In/Out Connector Size:	1" MNPT 2.54 CM

WARRANTY CERTIFICATE

THE TROJAN UV612 AND UV612 PLUS ULTRAVIOLET WATER STERILIZERS ARE GUARANTEED BY THE MANUFACTURER TO BE FREE FROM DEFECTS IN MATERIAL AND WORKMANSHIP FOR A PERIOD OF (1) ONE YEAR FROM DATE OF PURCHASE, 5 YEARS ON THE STAINLESS STEEL WATER CHAMBER. THIS WARRANTY WILL BE VOID IF THE PRODUCT IS ALTERED OR MISUSED IN ANY WAY.

TO ENSURE PROPER PERFORMANCE OF THE UV STERILIZER, THE WATER PASSED THROUGH THE STERILIZER UNIT SHOULD NOT CONTAIN MORE THAN .2 PARTS PER MILLION OF IRON; .3 PARTS PER MILLION MANGANESE; .125 PARTS PER MILLION OF HYDROGEN SULPHIDE OR ANY FILTERABLE SOLIDS.

THIS WARRANTY DOES NOT OBLIGATE THE MANUFACTURER TO BEAR THE COST OF TRANSPORTATION IN CONNECTION WITH THE REPLACEMENT OF DEFECTIVE PARTS.

NEITHER THE SELLER NOR THE MANUFACTURER WILL BE LIABLE FOR ANY INJURY, LOSS OR DAMAGE ARISING EITHER DIRECTLY OR CONSEQUENTLY FROM THE USE OF/OR THE INABILITY TO USE THE STERILIZER. THE USER ASSUMES ALL RESPONSIBILITY AND LIABILITY WHATSOEVER IN CONNECTION WITH THE INSTALLATION AND USE OF THE STERILIZER.

NO EXPRESSED, IMPLIED OR STATUTORY WARRANTY OTHER THAN HEREIN SET FORTH IS MADE OR AUTHORIZED TO BE MADE.

TROJAN TECHNOLOGIES INC.