



Emma Wireless

Wireless thermostat

User Guide
EN NL DE FR

Optional: Connect to Adam HA hub for smart functions

NL Optioneel: Slimme functies via de Adam HA hub

DE Optional: Smarte Funktionen über den Adam HA hub

FR Optionnel: Fonctionnalités via le Adam HA hub



Emma

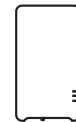

Adam HA



Plugwise Home



Daily use

NL Dagelijks gebruik

DE Tägliche Nutzung

FR Utilisation quotidienne

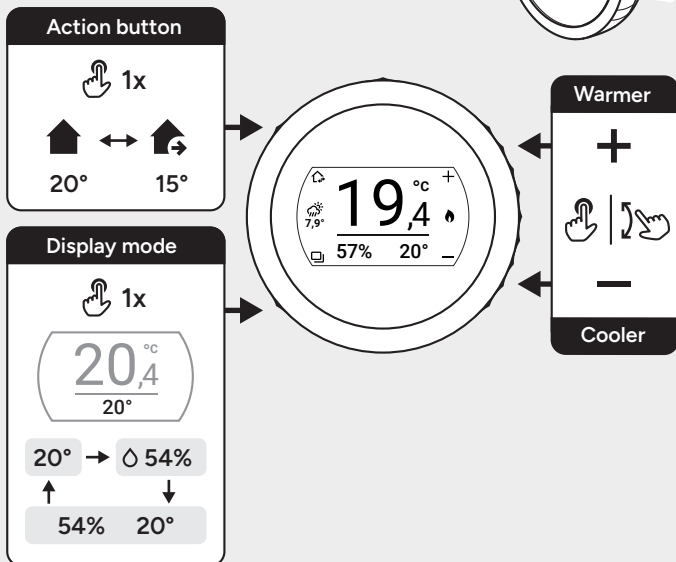

Adjusting Settings

NL Instellingen aanpassen

DE Einstellungen anpassen

FR Modifier les paramètres

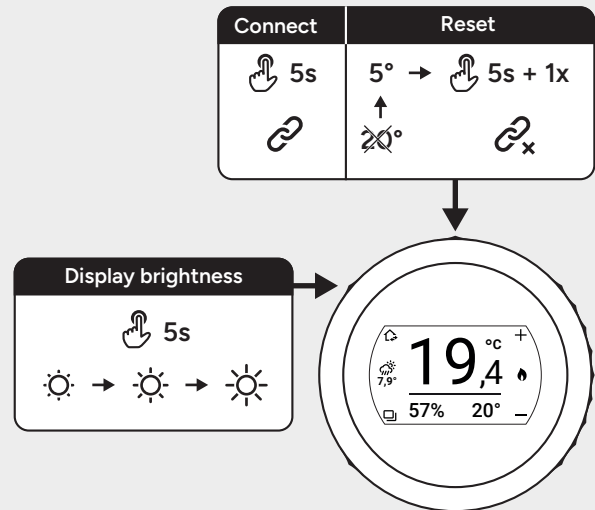

Screen information NL Scherminformatie DE Bildschirminformationen FR Informations sur les l'écran

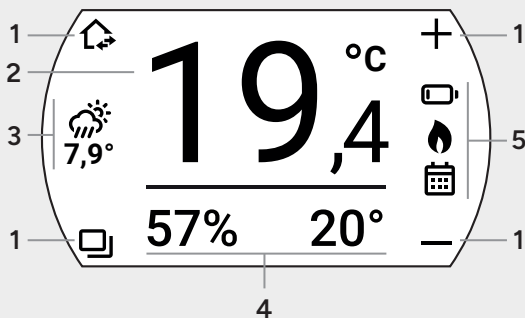

1. Side button indicator

NL Zijknoppenindicatoren

DE Seitliche Tastenanzeigen

FR Indicateurs de boutons latéraux

2. Measured temperature

NL Gemeten temperatuur

DE Gemessene Temperatur

FR Température mesurée

3. Outdoor weather ¹⁾

NL Weer buiten

DE Wetter draußen

FR Météo extérieure

4. Humidity & setpoint

NL Luchtvochtigheid & ingestelde waarde

DE Luftfeuchtigkeit & Eingestellte Temperatur

FR Humidité & température de consigne

5. System status

NL Systeemstatus











DE État du système

FR Systemstatus

¹⁾ Requires Plugwise hub NL Plugwise-hub vereist DE Erfordert Plugwise-Hub FR Nécessite un hub Plugwise

²⁾ Requires Plugwise hub or another zigbee compatible hub NL Vereist een Plugwise-hub of een andere Zigbee-compatibele hub DE Erfordert einen Plugwise-Hub oder einen anderen Zigbee-kompatiblen Hub. FR Nécessite un hub Plugwise ou un autre hub compatible Zigbee.

Icon guide NL Icoongids DE Symbolübersicht FR Guide des icônes

	Heating demand ¹⁾ NL Warmtevraag DE Wärmebedarf FR Demande de chaleur		Low battery NL Batterij bijna leeg DE Batterie schwach FR Batterie faible		Ready to connect ²⁾ NL Klaar om te verbinden DE Bereit zur Verbindung FR Prêt à se connecter
	Cooling demand ¹⁾ NL Koelvraag DE Kühlanforderung FR Demande de refroidissement		Schedule active ¹⁾ NL Schema actief DE Zeitplan aktiv FR Programme actif		Reconnecting... ²⁾ NL bezig met opnieuw verbinden... DE Verbindung wird wiederhergestellt... FR Reconnexion en cours...
	Off ¹⁾ NL Uit DE Aus FR Arrêt		Display brightness NL Schermhelderheid DE Display-Helligkeit FR Luminosité de l'écran		Connected ²⁾ NL Verbonden DE Verbunden FR Connecté
	Domestic Hot Water (DHW) active ¹⁾ NL Tapwater actief DE Warmwasser aktiv FR Eau chaude sanitaire active		Display locked ²⁾ NL Display vergrendeld DE Display gesperrt FR Écran verrouillé		

Replacing the batteries NL Batterijen vervangen DE Batterien ersetzen FR Remplacement des piles

Use alkaline or rechargeable batteries.
NL Gebruik alkaline- of oplaadbare batterijen.
DE Verwende Alkaline- oder wiederaufladbare Batterien.
FR Utilisez des piles alcalines ou rechargeables.

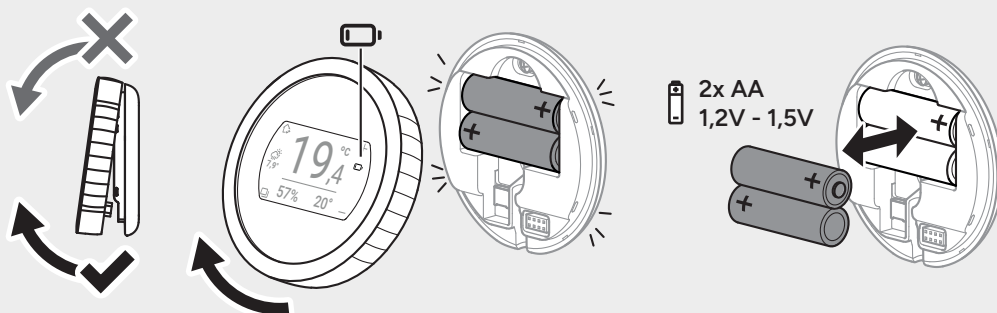

Troubleshooting NL Problemen oplossen DE Fehlerbehebung FR Dépannage



Blank screen
NL Leeg scherm
DE Leeres Display
FR Écran vide

No power to thermostat. Check USB-C cable or batteries.

Geen voeding naar de thermostaat. Controleer de USB-C-kabel of de batterijen.
Keine Stromversorgung des Thermostats. Überprüfen Sie das USB-C-Kabel oder die Batterien.
Pas d'alimentation du thermostat. Vérifiez le câble USB-C ou les piles.

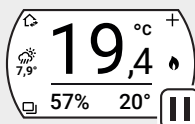

Display not updating
NL Display wordt niet bijgewerkt
DE Display wird nicht aktualisiert
FR L'écran ne se met pas à jour

Display retains last image when power is lost. Check USB-C cable or batteries. If you remove the front and put it back on, Emma will restart. You'll see the Plugwise logo while it's booting up.

Display toont laatste beeld bij stroomuitval. Controleer de USB-C-kabel of de batterijen. Als je de voorkant verwijdert en weer terugplaatst, start Emma opnieuw op. Tijdens het opstarten zie je het Plugwise-logo verschijnen.
Display zeigt letztes Bild bei Stromausfall. Überprüfen Sie das USB-C-Kabel oder die Batterien. Wenn du die Front abnimmst und wieder anbringst, startet Emma neu. Während des Startvorgangs wird das Plugwise-Logo angezeigt.
L'écran affiche la dernière image en cas de coupure. Vérifiez le câble USB-C ou les piles. Si vous retirez la façade et la remettez en place, Emma redémarrera. Vous verrez le logo Plugwise pendant le démarrage.