

CLUTCH PLATE DATA:		PART NUMBER 1742	MERCEDES 722.4 1984-UP K2 4th
NUMBER OF TEETH	6		
OUTSIDE DIAMETER	4.640±.010	ALLOMATIC 609 EAST CHANEY STREET SULLIVAN, INDIANA 47882 www.alloomatic.com	
INSIDE DIAMETER	3.250±.010		
OVERALL THICKNESS	.138±.003		

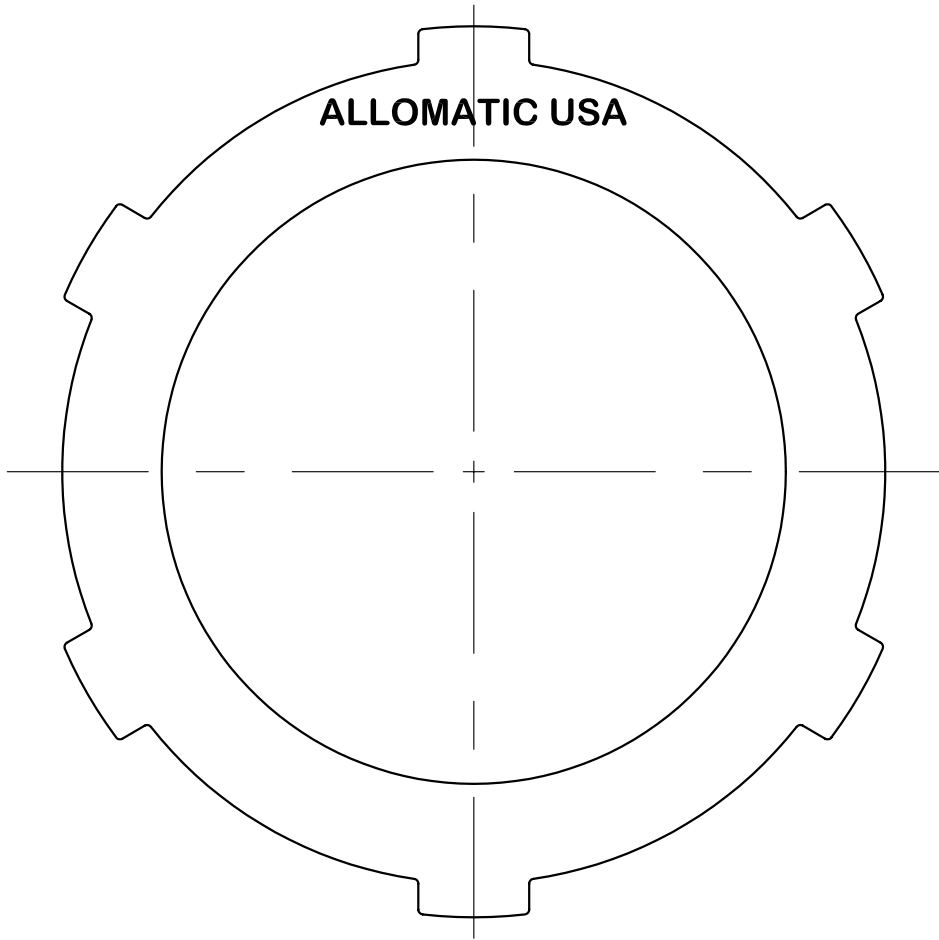

04/10/03