

<b>CLUTCH PLATE DATA:</b>		PART NUMBER <b>1785</b>	VW/AUDI AG4 1990-UP
NUMBER OF TEETH	3		
OUTSIDE DIAMETER	7.248±.010	<b>ALLOMATIC</b> 609 EAST CHANEY STREET SULLIVAN, INDIANA 47882 <a href="http://www.alloomatic.com">www.alloomatic.com</a>	<b>B2 BRAKE (FRONT) STEEL</b>
INSIDE DIAMETER	5.360±.010		
OVERALL THICKNESS	.118±.003		

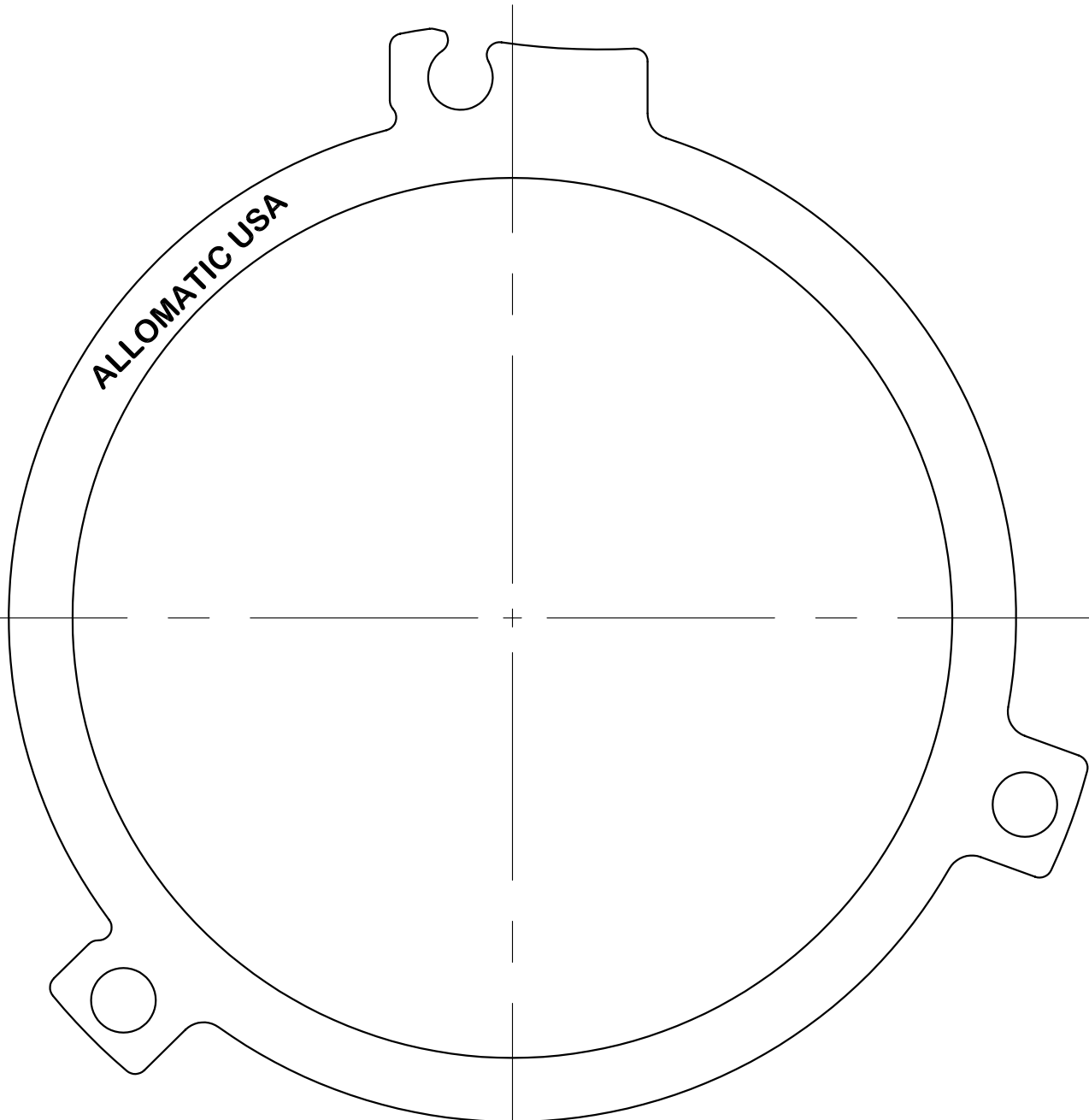

04/10/03