

SpectraMax iD3

Multi-Mode Microplate Reader User Guide

SpectraMax iD3 Multi-Mode Microplate Reader User Guide

This document is provided to customers who have purchased Molecular Devices equipment, software, reagents, and consumables to use in the operation of such Molecular Devices equipment, software, reagents, and consumables. This document is copyright protected and any reproduction of this document, in whole or any part, is strictly prohibited, except as Molecular Devices may authorize in writing.

Software that may be described in this document is furnished under a non-transferrable license. It is against the law to copy, modify, or distribute the software on any medium, except as specifically allowed in the license agreement. Furthermore, the license agreement may prohibit the software from being disassembled, reverse engineered, or decompiled for any purpose.

Portions of this document may make reference to other manufacturers and/or their products, which may contain parts whose names are registered as trademarks and/or function as trademarks of their respective owners. Any such usage is intended only to designate those manufacturers' products as supplied by Molecular Devices for incorporation into its equipment and does not imply any right and/or license to use or permit others to use such manufacturers' and/or their product names as trademarks.

Each product is shipped with documentation stating specifications and other technical information. Molecular Devices products are warranted to meet the stated specifications. Molecular Devices makes no other warranties or representations express or implied, including but not limited to, the fitness of this product for any particular purpose and assumes no responsibility or contingent liability, including indirect or consequential damages, for any use to which the purchaser may put the equipment described herein, or for any adverse circumstances arising therefrom. The sole obligation of Molecular Devices and the customer's sole remedy are limited to repair or replacement of the product in the event that the product fails to do as warranted.

For research use only. Not for use in diagnostic procedures.

The trademarks mentioned herein are the property of Molecular Devices, LLC or their respective owners. These trademarks may not be used in any type of promotion or advertising without the prior written permission of Molecular Devices, LLC.

Patents: <http://www.moleculardevices.com/patents>

Product manufactured by Molecular Devices, LLC.
3860 N. First Street, San Jose, California, 95134, United States of America.
Molecular Devices, LLC is ISO 9001 registered.
©2022 Molecular Devices, LLC.
All rights reserved.



Contents

Safety Information	5
Warnings, Cautions, Notes, and Tips	5
Chapter 1: Introduction	11
Computer Integration	11
Applications	15
Environmental Control	15
Optics	15
Plate Controls	16
Injectors	16
Chapter 2: Setting Up the Instrument	17
Package Contents	17
Unpacking the Instrument	19
Removing the Transport Locks	21
Connecting Instrument Cables	24
Assembling and Maintaining Injectors	25
Chapter 3: Getting Started	29
Welcome	30
Defining Date, Time, and Global Read Settings	31
Getting the Instrument on Your Network	32
Maintaining Users	33
Chapter 4: Home Page	35
Changing PIN/Logout	36
Quick Start and Favorites	37
Protocol Libraries	38
External Shake Settings	40
Temperature Settings	41
Maintaining Injectors	42
Maintenance Page	52
Loading and Unloading Plates	53
Chapter 5: Protocols	55
Viewing Protocol Settings	55
Defining Protocol Settings	57

Read	70
Result Library	71
Chapter 6: Read Modes and Read Types	77
Absorbance Read Mode	79
Fluorescence Intensity Read Mode	83
Luminescence Read Mode	87
Chapter 7: Maintenance and Troubleshooting	91
Preventive Maintenance	91
Cleaning the Instrument	91
Cleaning Injectors and Accessories	92
Troubleshooting	93
Before You Move the Instrument	95
Obtaining Support	100
Appendix A: Instrument Specifications	101
Measurement Specifications	101
Physical Specifications	104
Injector Specifications	106
Appendix B: Accessories	109
Injector Accessories	109

Safety Information

Information about the safe use of the instrument from Molecular Devices® includes an understanding of the user-attention statements in this guide, the safety labels on the instrument, precautions to follow before you operate the instrument, and precautions to follow while you operate the instrument.

Make sure that everyone involved with the operation of the instrument has:

- Received instruction in general safety practices for laboratories.
- Received instruction in specific safety practices for the instrument.
- Read and understood all Safety Data Sheets (SDS) for all materials being used.

Read and observe all warnings, cautions, and instructions. The most important key to safety is to operate the instrument with care.



WARNING! If the instrument is used in a manner not specified by Molecular Devices, the protection provided by the equipment might be impaired.

Warnings, Cautions, Notes, and Tips

All warning symbols are framed within a yellow triangle. An exclamation mark is used for most warnings. Follow the related safety information. Other symbols can warn of other types of hazards such as biohazard or electrical warnings as are described in the text of the warning.

The following user attention statements can display in the Molecular Devices user documentation. Each statement implies the amount of observation or a recommended procedure.



WARNING! A warning indicates a situation or operation that could cause personal injury if precautions are not followed.



CAUTION! A caution indicates a situation or operation that could cause damage to the instrument or loss of data if correct procedures are not followed.









Note: A note calls attention to significant information.



Tip: A tip provides useful information or a shortcut, but is not essential to the completion of a procedure.

Symbols on the Instrument













Each safety label on the instrument contains an alert symbol that indicates the type of potential safety hazard.

Symbol	Indication
	Consult the product documentation.
	Potential lifting hazard. To prevent injury, use a minimum of two people to lift the instrument.
	Potential pinch hazard.
	Potential biohazard.
	Potential heat hazard.
	Electrostatic sensitive device (ESD). Observe precautions to handle electrostatic sensitive devices.
	Potential laser hazard. The instrument is rated a Class 1 Laser Product because it can use an optional read module that contains a laser. The laser light cannot be accessed.

Near-field Communication

This equipment has been tested and found to comply with the limits for a Class A digital device, pursuant to part 15 of the FCC Rules. These limits are designed to provide reasonable protection against harmful interference when the equipment is operated in a commercial environment. This equipment generates, uses, and can radiate radio frequency energy and, if not installed and used in accordance with the instruction manual, may cause harmful interference to radio communications. Operation of this equipment in a residential area is likely to cause harmful interference in which case the user will be required to correct the interference at their own expense. Changes or modifications made to this equipment not expressly approved by the party responsible for compliance may void the FCC authorization to operate this equipment.

A sticker on the back of the instrument displays the following symbols:

Symbol	Indication
	The instrument serial number.
	The instrument manufacture date.
	You should consult the instructions for use.
	CSA certification.
	European technology conformity.
	United Kingdom and/or Korean technology conformity.
	The instrument complies with Australian radio communication requirements.
	This symbol is required in accordance with the Waste Electrical and Electronic Equipment (WEEE) Directive of the European Union. It indicates that you must not discard this electrical or electronic product or its components in domestic household waste or in the municipal waste collection system. For products under the requirement of the WEEE directive, contact your dealer or local Molecular Devices office for the procedures to facilitate the proper collection, treatment, recovery, recycling, and safe disposal of the device.
	Indicates the environmental friendly use period.
	There is an authorized representative in the European community.
	The instrument manufacturer.
	The manufacturer catalog number.



- California proposition 65 requires businesses to provide warnings to Californians about significant exposures to chemicals that cause cancer, birth defects, or other reproductive harm.

Laser Safety



WARNING! LASER LIGHT. This symbol indicates that a potential hazard to personal safety exists from a laser source. When this symbol displays in this guide, be careful to follow the specific safety information related to the symbol.

The SpectraMax iD5 is rated a Class 1 Laser Product because you can install an optional read mode module that contains a laser. The laser light cannot be accessed.

The instrument is equipped with a redundant laser safety system. A hardware interlock prevents the laser in the module from turning on, unless the plate chamber door and the instrument left hood are closed. The user or the service engineer is not exposed to radiation from any laser module during operation, maintenance, or service. The closed plate chamber provides the protective housing.



WARNING! LASER LIGHT. Operate the instrument only when the plate chamber door and the instrument left hood are closed.

Some modules can have a laser or laser diode up to Laser Class 4 that is inside the module. The lasers are non-operational until after the module is properly installed in the instrument.



Note: At the time this user guide was authored, no SpectraMax iD5 modules contain a laser but future modules are being considered.

Electrical Safety

To prevent electrical injuries and property damage, inspect all electrical equipment before use and report all electrical deficiencies. Contact Molecular Devices technical support for equipment service that requires the removal of covers or panels.



WARNING! HIGH VOLTAGE. Within the instrument is the potential of an electrical shock hazard existing from a high voltage source. Read and understand all safety instructions before you install, maintain, and service the instrument.

To prevent electrical shock, use the supplied power cord and connect to a properly grounded wall outlet.

To ensure sufficient ventilation and provide access to disconnect power from the instrument, maintain a 20 cm to 30 cm (7.9 in. to 11.8 in.) gap between the rear of the instrument and the wall.

Power off the instrument when not in use.

Moving Parts Safety

The instrument contains moving parts that can cause injury. Under normal conditions, the instrument is designed to protect you from these moving parts.



WARNING! If the instrument is used in a manner not specified by Molecular Devices, the protection provided by the equipment might be impaired.

To prevent injury:

- Never try to exchange labware, reagents, or tools while the instrument is operating.
- Never try to physically restrict the moving components of the instrument.
- Keep the instrument work area clear to prevent obstruction of the movement. Provide clearance in front of the instrument of 18 cm (7.1 in.) for the plate drawer.
- The instrument has adjustable optics to define the read height, or z-height. In a top read, the read height is the gap between the lens and the top of the plate, or the top of the lid if the plate is lidded.

A transport lock is placed on the plate drawer to protect the instrument from damage during shipping. You must remove the transport lock before you power on the instrument. See [Plate Controls](#), see page 16.



WARNING! Do not attempt to access the interior of the instrument unless specifically instructed to do so. The moving parts inside the instrument can cause injury. Do not operate the instrument with any covers or panels removed.

Chemical and Biological Safety

Normal operation of the instrument can involve the use of materials that are toxic, flammable, or otherwise biologically harmful. When you use such materials, observe the following precautions:

- Handle infectious samples based on good laboratory procedures and methods to prevent the spread of disease.
 - Observe all cautionary information printed on the original containers of solutions before their use.
 - Dispose of all waste solutions based on the waste disposal procedures of your facility.
 - Operate the instrument in accordance with the instructions outlined in this guide, and take all the required precautions when using pathological, toxic, or radioactive materials.
 - Splashing of liquids can occur. Take applicable safety precautions, such as using safety glasses and wearing protective clothing, when working with potentially hazardous liquids.
 - Observe the applicable cautionary procedures as defined by your safety officer when using hazardous materials, flammable solvents, toxic, pathological, or radioactive materials in or near a powered-up instrument.
-



WARNING! Never use the instrument in an environment where potentially damaging liquids or gases are present.



CAUTION! When you use aggressive or corrosive reagents, you should have the plate automatically move out of the instrument after a read.



The SpectraMax® iD3 Multi-Mode Microplate Reader from Molecular Devices is a monochromator-based, multi-mode plate reader. The touchscreen interface provides integrated instrument control, data display, and the ability to export results over your network for statistical data analysis.

There are several instrument configurations.

- Base
- SpectraMax® Injector System with SmartInject™ (factory installed or by a Molecular Devices field representative)

The instrument supports the following read modes:

- [Absorbance Read Mode, see page 79](#)
- [Fluorescence Intensity Read Mode, see page 83](#)
- [Luminescence Read Mode, see page 87](#)

The instrument supports four read types. See [Read Modes and Read Types on page 77](#):

- Endpoint
- Kinetic
- Well Scan
- Spectrum

You can integrate the instrument with the StakMax® Microplate Handling System.

Computer Integration

The instrument touchscreen uses the embedded SoftMax Touch Software to run basic non-injector reads. You must use a computer running the SoftMax® Pro Data Acquisition and Analysis Software to operate the instrument for advanced acquisition settings and for protocols that use the SpectraMax Injector System.

Optional integration of the instrument with a computer allows you to export data over your intranet or to a USB drive in an Excel format for further analysis.

You can use the SoftMax Pro Software - Standard edition or the SoftMax Pro Software - GxP edition to have the instrument collect data from one or more plates and store the data in a single file, using the same or different instrument settings for different plates. Assays that require a read in two or more read modes or read types can be combined in a single experiment and run with a single command in the SoftMax Pro Software, by defining separate plate reads and enabling Auto Read. See the *SoftMax Pro Data Acquisition and Analysis Software User Guide*.





Note: When you use a computer running the SoftMax Pro Software to operate the instrument, the instrument touchscreen is locked.

For users that use the SoftMax Pro Software - GxP edition to operate the instrument, the user must have the following permission to lock and unlock the instrument touchscreen:

- SoftMax Pro Software - GxP edition version 7.0.3 users require the Sign Signature permission.
- SoftMax Pro Software - GxP edition version 7.1.x users require the Lock/Unlock Instrument permission.

In the Ribbon, on the GxP tab, users with appropriate permission can use the following icons to lock and unlock the instrument touchscreen:

- Click  **GxP Mode On** to lock the instrument touchscreen and operate the instrument from the computer running the SoftMax Pro Software in GxP mode. This locks the instrument touchscreen for all users and you must operate the instrument from a computer running the SoftMax Pro Software - GxP edition.
- Click  **GxP Mode Off** to release the lock from the instrument touchscreen and allow users to use the instrument touchscreen to run experiments.



Note: The instrument remains locked until the user with the appropriate permission clicks  **GxP Mode Off** to stop the GxP mode. You cannot use the Instrument Connection dialog to disconnect from an instrument that is locked in GxP mode.

Installing SoftMax Touch Software Updates

The instrument's SoftMax Touch Software version number displays on the Maintenance page - System Information tab:  > **System Information**.

- SoftMax Touch Software version 1.1 is compatible with SoftMax Pro Software SoftMax® Pro Data Acquisition and Analysis Software version 7.0.2.
- SoftMax Touch Software version 1.2 is compatible with SoftMax Pro Software version 7.0.3 and later.



The SoftMax Touch Software update uses a USB drive. When you insert the USB drive into one of the USB ports below the touchscreen, the update automatically starts and runs with no other user interaction required. You cannot uninstall an update.

Update File Explanation

The update file has the following naming convention: iDx_update_n_n_nnnnnn.mdup

- **iDx_update:** Use the SoftMax Touch Software update files to update the software in both the SpectraMax iD3 AND the SpectraMax iD5 instruments. The update is intelligent and knows which instrument software to update.
- **<n>_<n>:** Major software version and minor software version, for example: 1.2 displays as 1_2.
- **<nnnnnn>:** Build number. This is the most relevant number that you should compare to what displays on the instrument Maintenance page.
- **.mdup:** File extension.

Requirements:

- 1 empty USB drive with at least 500 MB free space

To update the SoftMax Touch Software:

1. From any web-enabled computer, go to www.moleculardevices.com/touchscreenupdate to display the latest available iDx_update_n_n_nnnnnn.mdup file.
2. On the instrument touchscreen, tap  > **System Information** and confirm that the instrument software number/build number combination is lower than the iDx_update_n_n_nnnnnn.mdup file numbers. If yes, continue to update.
3. Download the **iDx_update_n_n_nnnnnn.mdup** file to the USB drive.
4. Right-click the **iDx_update_n_n_nnnnnn.mdup** file and select **Properties**.

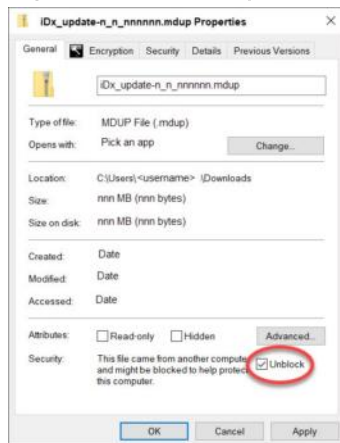

5. If the file is blocked (usually for downloads) select the **Unblock** check box and click **OK**.
6. Power on the instrument and wait for the initialization to complete. Confirm that the instrument is not performing any operations.
7. If the instrument is being operated by a computer running the SoftMax Pro Software or is locked by the SoftMax Pro GxP Software, turn off GxP mode and/or disconnect the instrument from the SoftMax Pro Software.

8. Insert the USB drive into one of the USB ports below the instrument touchscreen. The update starts automatically.







9. When the update message displays, tap **OK** to start the update process. An update can take up to 5 minutes.
10. When the update completes the instrument does a system restart. After the system restart finishes, remove the USB drive.
11. On the touchscreen, tap  > **System Information** and confirm that the software number/build number is same as the name of the update file.

Installing the QuickSync Tool

The QuickSync Tool allows a computer to receive the raw data that the instrument exports, within the security and firewall restrictions of your network. The computer on which you install the QuickSync Tool must be able to communicate with the instrument over your intranet or you can directly connect the computer to the instrument. This is usually the computer that runs the SoftMax Pro Software. After you synchronize the computer with the instrument, the instrument exports result data to the computer for further analysis. See [Using The QuickSync Tool on page 76](#).

 **Tip:** You can synchronize multiple computers to an instrument and multiple instruments to a computer.

To install the QuickSync Tool:

1. Insert the SoftMax Pro Software USB drive, DVD, or use alternative media. Locate and double-click **QuickSyncInstaller.n.n.exe** file to start the install.
2. When the "Do You Want to Allow This App..." message displays, click **Yes**. The installation starts.
3. On the Completing the Setup page, click **Finish**. The QuickSync Tool icon  appears on your desktop.
4. Double-click  to display the message QuickSync Ready and a smaller version of the  appears in the computer tray near the clock at the bottom of the computer screen. Wait for the computer to find the instrument.
5. Right-click  in the tray near the clock to display a menu and select **Available Services** to display the list of SpectraMax iD3 and SpectraMax iD5 instruments on your intranet and/or the instrument to which you connect the computer through an Ethernet cable.



6. Click the name of instruments to which to synchronize the computer. A check mark appears next to each instrument name to which the computer is synchronized.

Add Service by IP Address

If the name of the instrument does not appear in the list of available services, do the following:

1. Right-click  in the tray near the clock and select **Add Service by IP** to display the following.



2. Enter the IP address of the instrument to which to connect. See [Getting the Instrument on Your Network on page 32](#).
3. Click **Add Connect**.

 **Tip:** If the computer still cannot find the instrument, contact your IT help desk to make sure that your company network setup and company intranet security allow the communication between the computer and the instrument.

Applications

The high sensitivity and flexibility of the instrument make it useful for applications in the fields of biochemistry, cell biology, immunology, molecular biology, and microbiology.

Typical applications include ELISA, nucleic acid, protein, enzymatic type homogeneous and heterogeneous assays, microbial growth, endotoxin testing, and pipettor calibration.

Application notes with specific application protocol suggestions are in the Information Center and Knowledge Base on the Molecular Devices web site at www.moleculardevices.com.

Environmental Control

The instrument can maintain the temperature inside the plate chamber at 5°C (9°F) above ambient to 66°C (150°F). The temperature sensors detect the temperature of the air inside the chamber, not the temperature of the samples in the plate. If you use the instrument to warm the samples, use a seal or lid on the plate to prevent evaporation of the sample. See [Temperature Settings on page 41](#).

Optics

The 2x2 monochromators permit individual optimization of wavelengths for both excitation and emission in fluorescence readings. Mirrored optics shape the light, and a height-adjustable objective lens focuses the beam into the sample volume. PMT Gain can be set to automatic, high, medium, or low.

Dynamic Range

The dynamic range of detection is approximately from 10^{-6} to 10^{-12} molar fluorescein. Variations in measured fluorescence values are virtually eliminated by internal compensation for detector sensitivity, photomultiplier tube voltage and sensitivity, and excitation intensity. The photometric range is 0.000 to 4.000 ODs with a resolution of 0.001 OD.



CAUTION! Never touch the optic mirrors, lenses, filters, or cables. The optics are extremely delicate, and critical to the function of the instrument.



CAUTION! Use of organic solvents can cause harm to the optics in the instrument. Extreme caution is recommended when you use organic solvents. Always use a plate lid and do not place a plate that contains these materials in the plate chamber for prolonged periods of time. Damage caused by the use of incompatible or aggressive solvents is NOT covered by the instrument warranty.

Plate Controls

You can place plates up to a height of 22 mm in the instrument plate drawer. A camera detects the height of a plate and confirms that the height is consistent with the plate type you select and that you position the plate properly on the plate drawer.

Depending on the application, the instrument can read 6, 12, 24, 48, 96, and 384-well plates. For micro-volume measurements, the instrument supports SpectraDrop 24-well Low Volume Microplate and SpectraDrop 64-well Low Volume Microplate. See [Plate Format and Plate Type Settings on page 59](#).

To read cuvettes, the instrument supports the use of the SpectraCuvette™ adapter that has the 22 mm plate height sticker.



CAUTION! SpectraCuvette Adapters without a sticker have a plate height of 24 mm and cannot be used in the SpectraMax iD3 or SpectraMax iD5. To prevent damage to the instrument, the height of the plate must not exceed 22 mm, including the lid if the plate is lidded.

Shake

You can operate a shake feature independently from a protocol to mix the contents of the wells in a plate outside of the plate chamber for visual inspection. This makes it possible to do kinetic analysis of solid-phase, enzyme-mediated reactions. See [External Shake Settings on page 40](#).

You also define shake settings as part of each protocol. The protocol shake setting depends on the read mode you select. See [Shake Settings on page 68](#).

Injectors

Instruments configurations that include the SpectraMax Injector System can deliver a reagent to the wells of a plate. You can use injectors for all read modes.

When your instrument configuration includes injectors, the instrument right hood has a handle,

and the  icon is enabled on the left side of the Home page.



Note: You must use a computer running the SoftMax Pro Software to operate the instrument for advanced acquisition or injector protocols.

The SoftMax Pro Software can set up the instrument to inject and read well by well to reduce signal loss. To define the settings for a read with injection, you must use the Acquisition View on the Settings dialog. See the SoftMax Pro Software application help for details.

Use the Injector Maintenance page to wash, prime, and calibrate the injectors. See [Maintaining Injectors on page 42](#).



WARNING! BIOHAZARD. Depending on your usage, the injectors can have biohazardous material in and on them. Always use the personal protective equipment (PPE) prescribed by your laboratory.

Chapter 2: Setting Up the Instrument

2

Before you unpack and setup the SpectraMax iD3, prepare a flat work area that has sufficient space for the instrument and required cables. See [Instrument Specifications on page 101](#).

All software required to run basic non-injector reads is installed in the instrument and is accessible from the touchscreen.

You can export data to a computer over your intranet, through a direct Ethernet cable, or to a USB drive in an Excel format for further analysis.

You must use a computer running the SoftMax Pro Software to operate the instrument for advanced acquisition settings and for protocols that use the SpectraMax Injector System. If you use the SoftMax Pro Software to operate the instrument, you must install the QuickSync Tool software on the computer running the SoftMax Pro Software. See the *SoftMax Pro Data Acquisition and Analysis Software User Guide* and [Installing the QuickSync Tool on page 14](#).



Note: When you use a computer running the SoftMax Pro Software to operate the instrument, the instrument touchscreen is locked.

Package Contents

The package contains the instrument plus a box that contains the tools and accessories.

Illustration	Part Number	Description
	Latest Version	SoftMax Pro Software with Product Key and QuickSync tool
	5054744	Installation guide
	YW 000 006	Hex key, 2.0 mm
	YW 000 012	Holex HEXAGON ballhead bolt driver 3 mm
	5052189	CAT6 Ethernet cable, 2 meter (6.56 foot)
	4400-0002 or 4400-0036	Power cord, 115 V or Power cord, 230 V
	5061514	Near Field Communication (NFC) magnets.
	5056339	Near Field Communication (NFC) key fob (NTAG 213, 180 byte).

When your instrument has the SpectraMax Injector System the package also contains the following.

Package Contents for Injectors

Illustration	Part Number	Description
	5055247	Injector Nozzle
	5044164	Tubing
	5055251	Bottle Holder
	5044165	Bottle Adapters
	5044163	Waste Plate
	Cannot order from Molecular Devices Wide-neck bottle, HDPE 50 mL capacity 36 mm square by 68 mm high 24 mm diameter inside neck Recommended supplier: VWR (215-0440)	Bottles
	Cannot order from Molecular Devices Strip wells, polystyrene 1x8, clear, flat-bottomed Recommended supplier: Greiner Bio-One (762001)	Strip well

For a complete list of the contents of the package, see the enclosed packing list.

Unpacking the Instrument

The packaging is designed to protect the instrument during transportation.

Transport locks are placed on the transport slide and the plate drawer to protect the instrument from damage during shipment. You must remove the transport locks before you power on the instrument.



WARNING! LIFTING HAZARD. To prevent injury, use a minimum of two people to lift the instrument.



Note: Retain the shipping box and all packaging materials for future transport needs. Do not use tools that can damage the packaging or the instrument.



CAUTION! When transporting the instrument, warranty claims are void if improper packing results in damage to the instrument.

To unpack the instrument:

1. Check the box for damage that occurred during transportation. Inform the supplier immediately and keep the damaged packaging.
-



CAUTION! Keep the box upright. Do not tip or tilt the box or place it on its side.

2. With the box facing up as indicated, cut open the tape on the side of the box labeled **Open Here**.



3. Grasp the handle on the cardboard and slide the instrument out of the box.

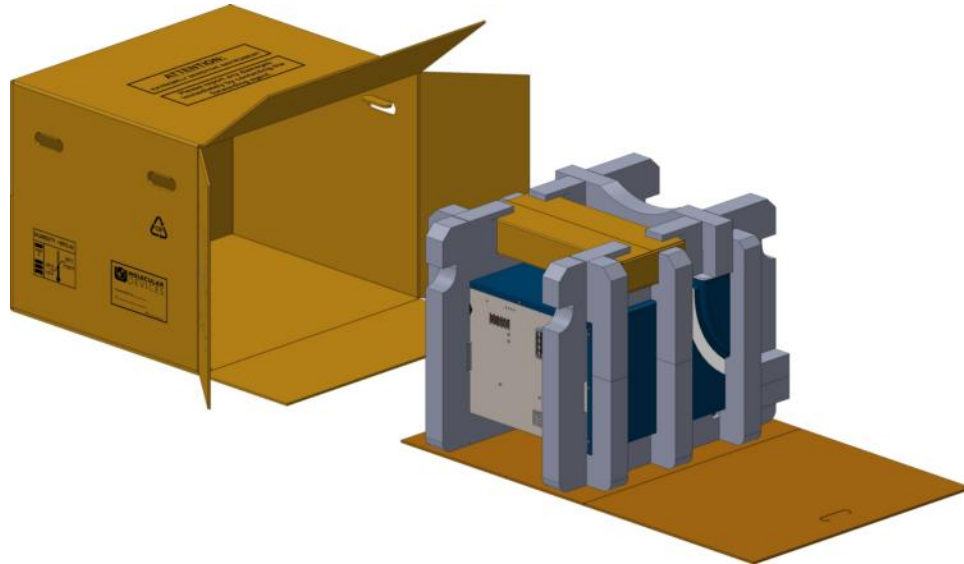

4. Remove the accessories tool box.

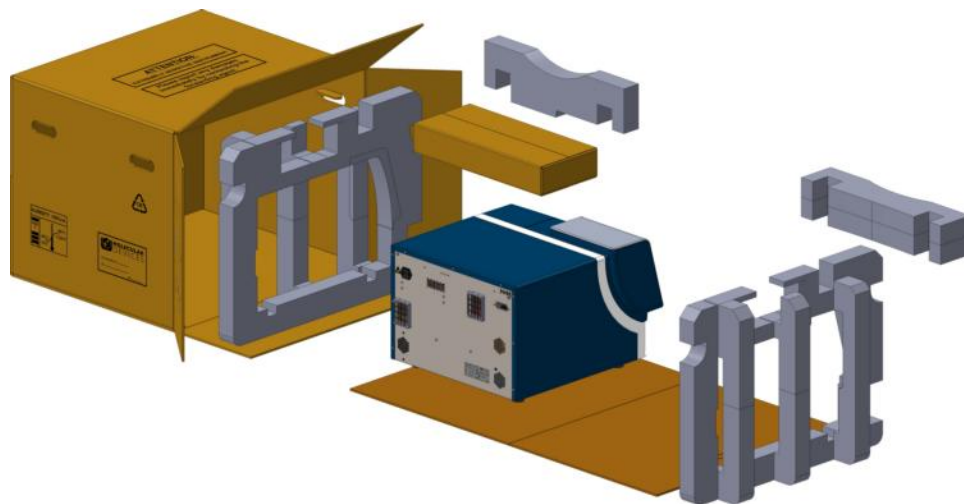

CAUTION! Keep the instrument upright and level when lifting. Do not tip or shake the instrument to prevent damage to the instrument.

5. Remove the foam packaging from both ends and then remove the plastic bag from the instrument.
6. With one person on each end, lift the instrument to a dry, flat area. You will need to access the back of the instrument to remove the transport lock and to connect the instrument cables.



Removing the Transport Locks



CAUTION! The instrument can be damaged if the transport locks are not removed before the instrument is powered on.

Transport locks are placed on the transport slide and the plate drawer to protect the instrument during shipment.

Required Tools

Illustration	Part Number	Description
	YW 000 006	Hex key, 2.0 mm
	YW 000 012	Hoxex HEXAGON ballhead bolt driver 3 mm



CAUTION! Do not touch or loosen screws or parts other than those specifically designated in the instructions. Doing so could cause misalignment and possibly void the warranty.

To remove the transport lock:

1. Remove the black cover from the travel lock opening in the center on the rear of the instrument. This cover prevents high dark counts for Luminescence reads and will be put back in after the following step.

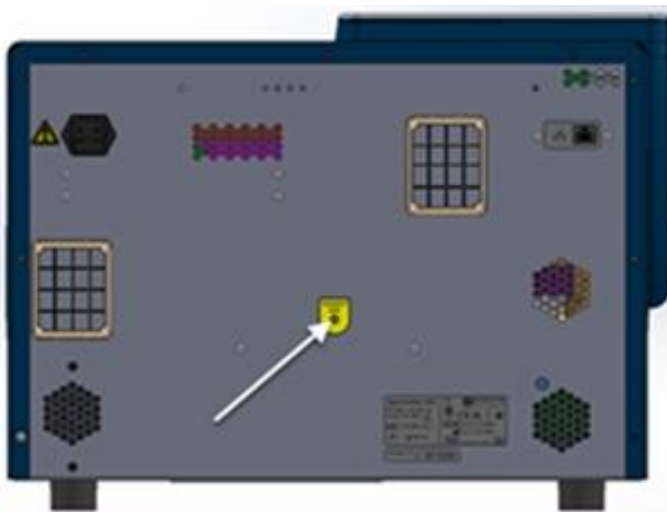

2. Use the provided 3.0 mm Horex HEXAGON ballhead bolt driver to loosen the screw located inside the Transport Lock opening until you feel the spring release. This unlocks the transport slide.

The screw remains inside the instrument. The screw is spring mounted and cannot get lost within the instrument.



Note: It can take a minimum of ten full turns to loosen the screw until you feel the spring release.



WARNING! If the instrument makes a grinding noise when you start a plate read, you have not released the transport slide.

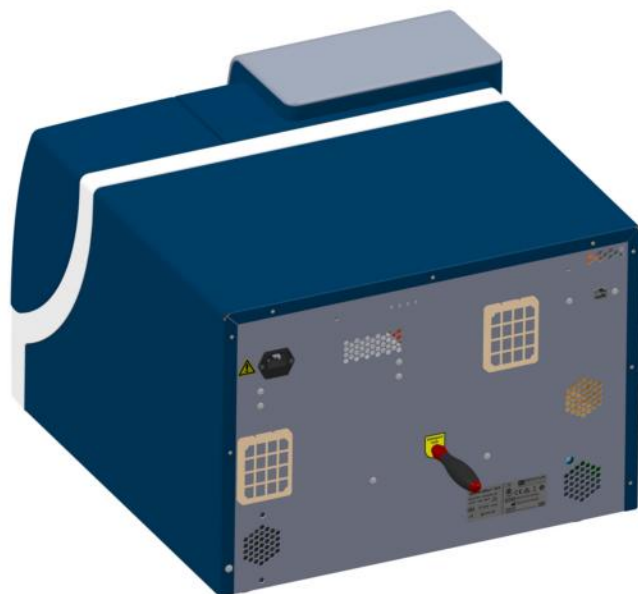

3. Replace the black cover in the travel lock opening. This cover prevents high dark counts for Luminescence reads.
4. On the front of the instrument, gently pull the yellow tab that protrudes from the plate chamber door to open the door. You must hold the plate drawer door open while you remove the transport lock.



Note: Be careful not to tear the yellow tab. It must remain attached to the transport lock to make it easier to open the plate chamber door.

- Use the provided 2.0 mm hex key to loosen screw #1 in the upper-left corner of the transport lock until the lock disconnects from the instrument frame. The screw has a retaining washer that prevents it from being removed from the lock.

*** Tip:** After you loosen screw #1, pull the plate drawer slightly out of the instrument to hold the chamber door open.

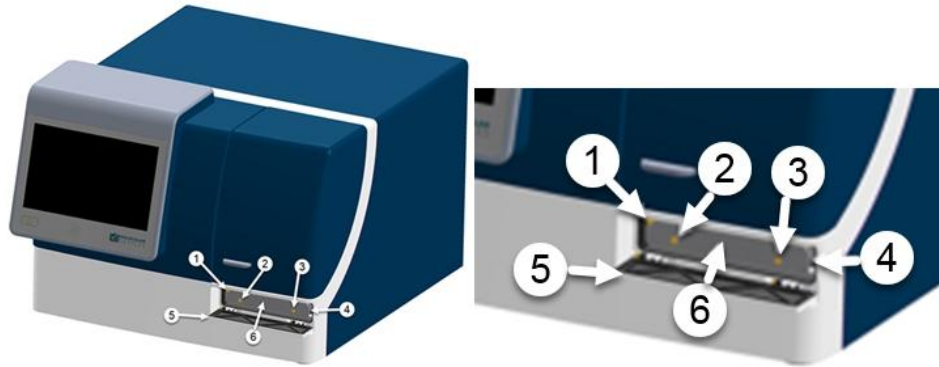

Plate Drawer Transport Lock



Item	Description
1	Screw #1 fastens the lock to the internal frame of the instrument
2	Screw #2 fastens the lock to the plate drawer
3	Screw #3 fastens the lock to the plate drawer
4	Plate drawer
5	Plate door in open position
6	Plate drawer transport lock

- Loosen screws #2 and #3 until the lock comes free of the plate drawer and you can remove the lock from the instrument. The screws have retaining washers that prevent them from being removed from the lock. Store the transport lock in the accessories tool box included with the microplate reader.
- Push the plate drawer back inside the instrument and close the chamber door.
- Save the original carton, foam inserts, accessories tool box, and transport locks for future shipments.

Connecting Instrument Cables

The power cord and Ethernet cable connect to the ports on the rear of the instrument. The Ethernet port allows you to connect the instrument to your intranet (like a printer) or to connect the instrument directly to a computer. When the instrument is connected to your intranet, you can synchronize any computer on the same intranet with the instrument, within security and firewall restrictions. You can synchronize multiple computers to an instrument and multiple instruments to a computer over your intranet.

Required Accessories

Illustration	Part Number	Description
	5052189	CAT6 Ethernet cable, 2 meter (6.56 foot)
	4400-0002 or 4400-0036	Power cord, 1 meter (3.3 foot)

To connect the cables to the instrument:

1. Connect one end of the supplied Ethernet cable to the Ethernet port on the instrument and then connect the other end of the Ethernet cable to a network wall outlet.

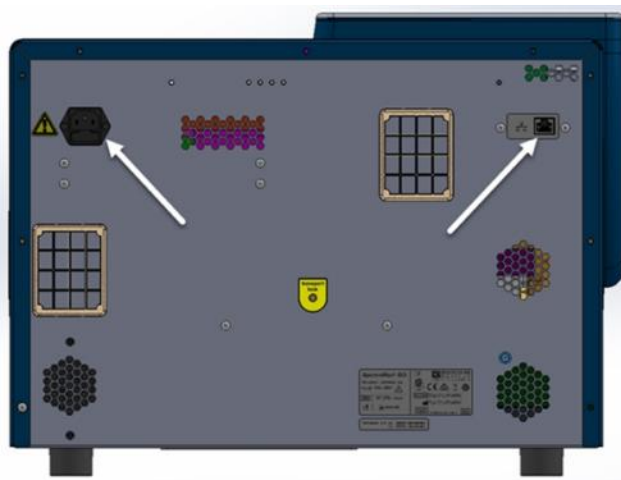

2. Use the power cord supplied with the instrument to connect the instrument to a grounded electrical wall outlet.

You can optionally connect the instrument directly to a computer.

1. Turn on the power to the computer.
2. Connect one end of an Ethernet cable to the port on the rear of the instrument and then connect the other end of the Ethernet cable to the Ethernet port on the computer. If the computer to which you intend to directly connect the instrument does not have an available Ethernet port, you can use an Ethernet (instrument side) to USB (computer side) adapter. (Adapter not included.)

Assembling and Maintaining Injectors

The SpectraMax Injector System is an optional addition to the base instrument configuration. If there is no handle on the instrument right hood, your instrument does not have injectors and the right hood is sealed shut. The hood should lift up with no resistance. Do not use excessive force to lift the hood.



WARNING! BIOHAZARD. Depending on your usage, the injector can have biohazardous material in and on it. Always use the personal protective equipment (PPE) prescribed by your laboratory.



The two injectors are located under the instrument right hood. Injector 1 is on the left and injector 2 is on the right as you face the instrument.

Bottle Holder



The bottle holder is mounted on two knobs.

1. Align the two slots on the bottle holder with the two pegs on the rail.
2. Lightly press the bottle holder into position.

Injector Tubing

Each injector has an injector tube. The tubing line connects to an injector tip on one end and a snorkel on the other end. From the tip, the tube passes around the injector pump to the snorkel. The tubing around the pump is held in position by two rubber bumpers and a stabilizer lid.

To deliver reagent, the SpectraMax Injector System uses peristaltic pumps. Peristaltic pump systems use rotors with rollers that compress and relax flexible tubing. Reagent enters the relaxed tubing and is then pushed through as the rotating roller compresses the tubing. Alternate relaxing and compressing of the tubing results in a continuous stream of reagent passing through the tubing.



Note: Over long periods of injector use, the elasticity of the tubing may decline and the volume delivered per pump turn may become smaller. See [Injector Tubing Status](#) on page 51.

The accuracy of the dispense volume is calibrated in the factory. You should periodically verify the dispense accuracy by running the gravimetric tubing calibration procedure. If the dispense accuracy changes, due to environmental conditions or the viscosity of the assay solution, use the volume adjustment setting to calibrate the dispense volume. When you replace worn out tubing, you should perform a before and after calibration to ensure consistent results. See [Injector Calibration](#) on page 49.

When not in use for long periods of time, open the stabilizer lids on top of the pumps to relieve compression on the tubing. This helps to retain uniformity of the tubing and ensure repeatability. Before use, make sure you close the stabilizer lids.

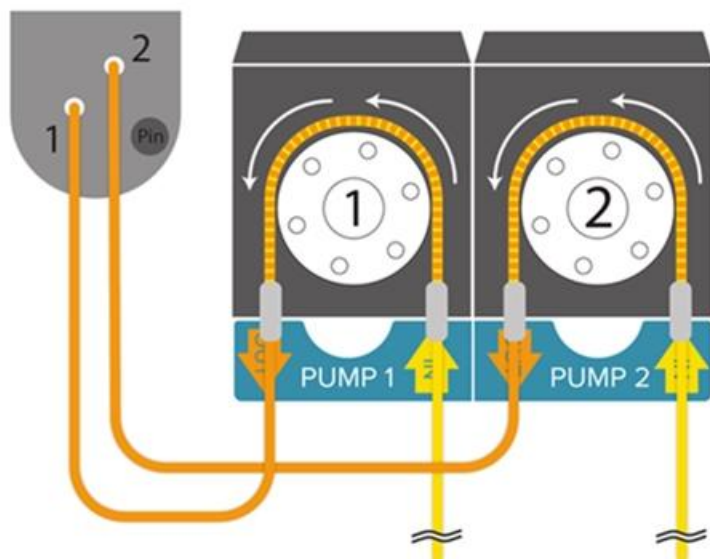

The tips slide into the nozzle. Move the nozzle to the injector arm above the open plate drawer for wash and prime functions. Move the nozzle to the opening located in the back left of the injector space within the instrument for injector protocols.

The snorkels are held in the bottles by snorkel clamps.

To install or replace the injector tubing:

1. Move the injector arm away from the instrument and insert the nozzle into the injector arm.

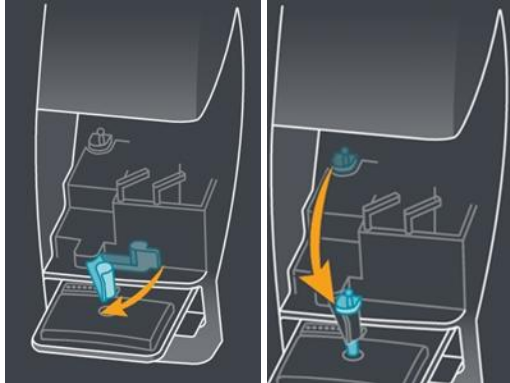

Do the following for both injectors.

2. Insert the snorkel into the bottle and then insert the snorkel into the snorkel clamp. Clamp for injector 1 is on the left and clamp for injector 2 is on the right.

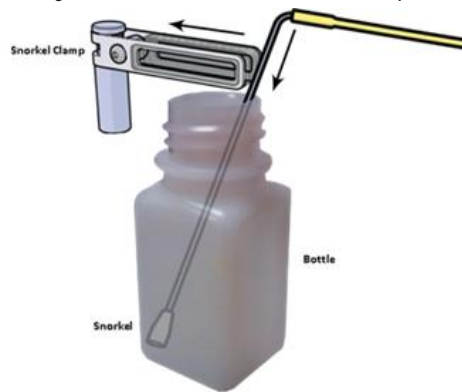

3. Pump 1 is on the left and pump 2 is on the right. Lift the stabilizer lid over the pump, press the bumper into the bumper slot on the input (right) side of the injector pump, gently pull the tubing around the injector pump, and then seat the bumper on the output (left) side of the injector pump.

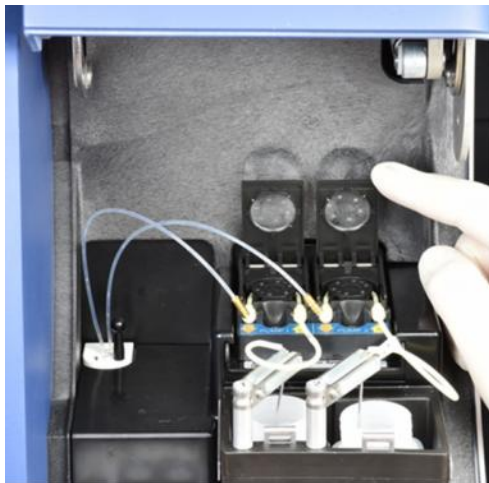

- Slide the tip into the nozzle, the slots are labeled 1 and 2 for injector 1 and injector 2.



- Use the black knob to move the nozzle back to the rear of the injector space. Align the nozzle with the opening and press straight down until you feel it snap into place.



- Move the injector arm to its original position.

All software required to run basic non-injector reads is installed in the instrument and is accessible from the touchscreen. You must use a computer running the SoftMax Pro Software to operate the instrument for advanced acquisition settings and for protocols that use the SpectraMax Injector System.

Near Field Communication (NFC) tags allow you to easily save and view the protocols that matter to you.

The power button and NFC sensor are directly below the touchscreen on the front of the instrument.



CAUTION! You must remove the transport locks before you power on the instrument. See [Removing the Transport Locks on page 21](#).

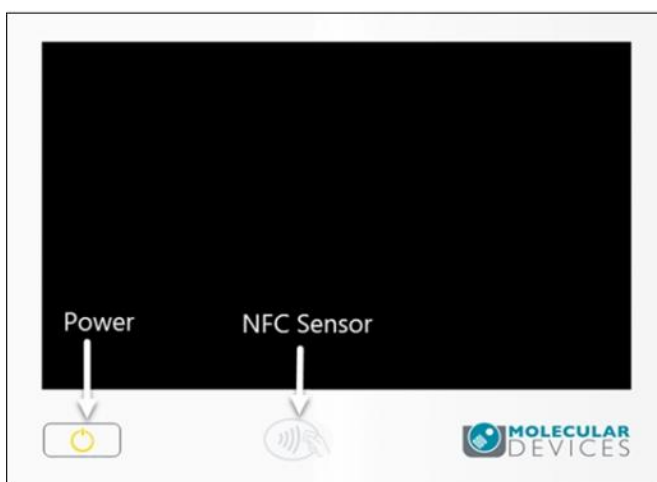

To power on the instrument:

1. If the instrument has injectors, close the injector hood.
2. Press the power button below the touchscreen.
3. Wait until the Welcome page displays and the  disappears.



Note: When the instrument has fully initialized, the  icon on the left displays a temperature.

If the instrument fails to initialize properly:

1. Make sure that the injector hood is closed.
2. Tap **OK** on the initialization message to shut down the system.
3. Press the power button to start the instrument again.
4. If the message continues to appear after several attempts, please contact Molecular Devices Technical Support. See [Obtaining Support on page 100](#).

Welcome

The Welcome page provides a list of the instrument features and allows you to select a user.

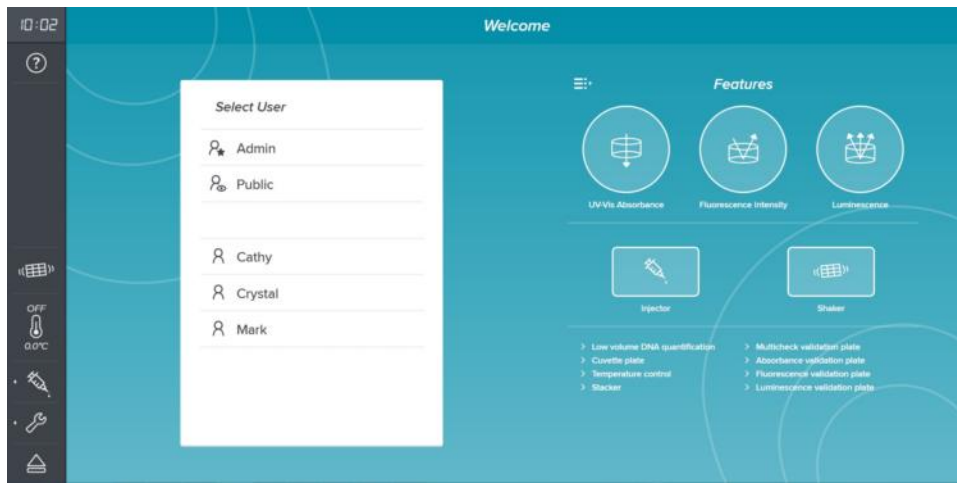

Tap each of the features to view the help topic related to each feature.









- Tap to hide the features.

The first time you power on the instrument, there are two users:

- **Admin** - User is responsible for user management. The Admin is restricted by a Personal Identification Number (PIN) that you must enter to use the instrument. See [Maintaining Users on page 33](#).
- **Public** - User is available to any user of the instrument and cannot be restricted by a PIN.
- **All Other Users** - In implementations where you want to maintain individual lists of protocols and/or you want to place restrictions on what users can see, the Admin can define user accounts.

The left side of the page provides the following icons that display in most workflows:

-  - Access page-specific application help.
-  - Shake plate outside of a defined protocol. See [External Shake Settings on page 40](#).
-  - Change the plate chamber temperature. See [Temperature Settings on page 41](#).
-  - Wash, prime, and calibrate the injectors. See [Maintaining Injectors on page 42](#).
-  - Access instrument maintenance settings. See [Maintenance Page on page 52](#).
-  - Open or close the plate drawer. See [Loading and Unloading Plates on page 53](#).

Defining Date, Time, and Global Read Settings





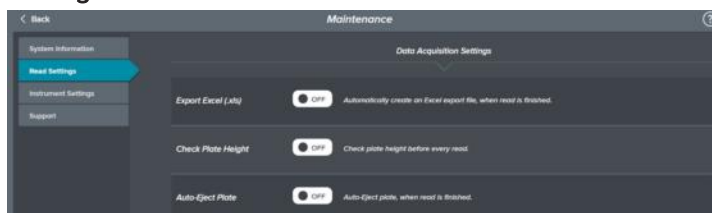

After you log in, you use the Maintenance page to define the system date/time and the global read settings that apply to all users of the instrument.

To Defining Date, Time, and Global Read Settings:

1. On the Welcome page, tap the **Public** user to display the Home page.
2. From the icons on the left, tap  to display the Maintenance page and tap the **Read Settings** tab.



3. The Read Settings tab provides the following options:

- Tap the **Export Excel**  to display  to have the instrument export data through an Ethernet cable to a computer that is on the same company network or is attached to the instrument. See [Exporting Result Data on page 75](#). You must insert a USB drive into the slot below the touchscreen or install the QuickSync tool on the computer. See [Installing the QuickSync Tool on page 14](#).
- Tap the **Check Plate Height**  to display  to have the instrument check the plate height before reads.
- Tap the **Auto-Eject Plate**  to display  to have the instrument open the plate drawer after each read completes.

4. Tap **Instrument Settings** to display the Instrument Settings tab.



5. The Instrument Settings tab provides the following options:
 - Use the **Brightness** slider to adjust the brightness of the touchscreen.
 - Use the **Volume** slider to change the volume of the instrument speakers that play the how-to videos. How-to videos are on the Support tab. See [Obtaining Support on page 100](#).
 - Tap the **Date Format** drop-down and select a format for date and time display.
 - Tap in the **Date/Time** field to display a calendar. Use the calendar to change the system date then tap the clock and use the scroll bars to change the time.
 - Tap **Set** to save the date/time changes.



Note: When you change the system date and time, the instrument software does an application re-start.

Getting the Instrument on Your Network

After you connect the Ethernet cable from the instrument to a networked wall outlet and after you power on the instrument, the instrument should automatically have an IP address assigned.



*** Tip:** You might have to work with your IT department to make sure your network will accept the addition of the instrument.

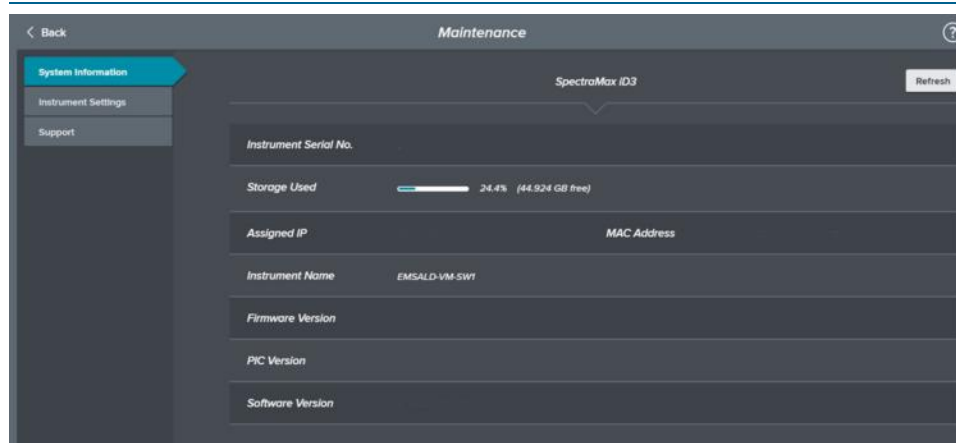

The Maintenance page has a System Information tab that allows you to view the instrument IP address. You do not need to log in as a user for this workflow.

1. From the buttons on the left, tap  to display the Maintenance page.
2. Tap **System Information** to display the System Information tab.
3. Tap **Refresh**. The instrument IP address can change due to network interruptions or when you power off the instrument. **Refresh** updates the display of the Assigned IP address.
4. The **Assigned IP** field displays the instrument IP address.



Note: If you plan to use a computer running the SoftMax Pro Software to operate the instrument, write down the IP address. You may need the IP address to connect the computer to the instrument.

Maintaining Users

The Admin user manages the user accounts on the instrument. When you log in as the Admin, the Maintenance page contains a Users tab. The Admin user can create user accounts to require a PIN and/or an NFC tag. If a user forgets their PIN, the Admin assigns the user a new PIN that they can use to log in.



Note: When an account has a PIN and an NFC tag, the user does not need to enter their PIN if they use their NFC tag to log in.

The first time you power on the instrument, the Welcome page displays two users:

- **Admin** - User is responsible for user management. The Admin account is restricted by a PIN. You should immediately change the Admin user PIN and you can assign the Admin user an NFC tag. You cannot otherwise edit or delete the Admin. See [Changing PIN on page 36](#).
- **Public** - User is available to any user of the instrument. You cannot edit or delete The Public user and you cannot restrict the Public user by a PIN or NFC tag.

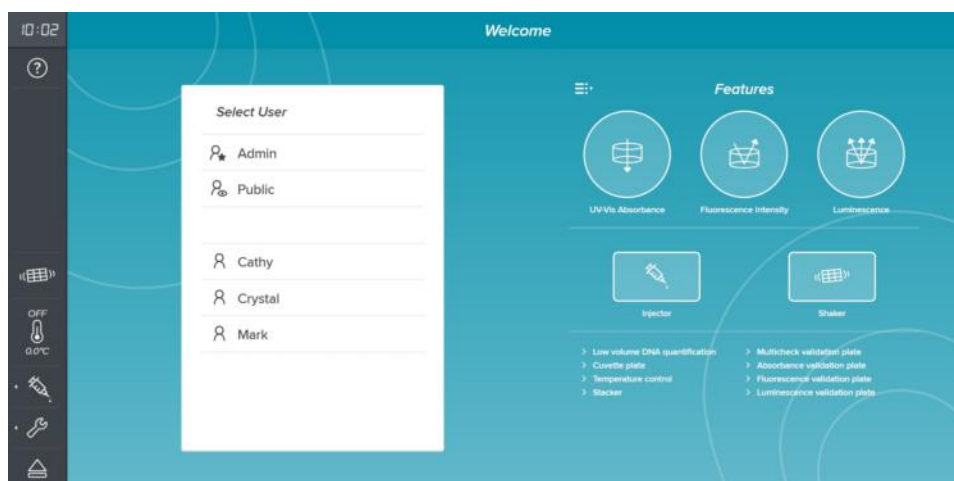

To have the Admin user manage users:





1. On the Welcome page, tap the **Admin** user to display the Enter PIN dialog.
2. Use the keypad to enter the Admin user's PIN and tap **Login**.

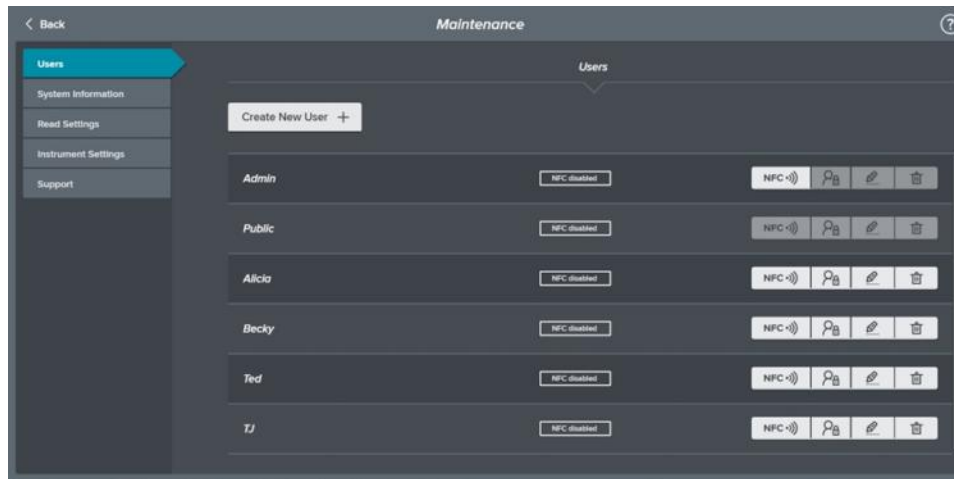

Note: For a new instrument enter 0000. You should change the Admin user PIN. See [Changing PIN on page 36](#).

- From the icons on the left, tap  to display the Maintenance page and tap **Users** to display the Users tab, if needed.



- Tap **Create New User** to display the New User dialog where you add a user.
- Tap the following to manage existing users:
 - Tap  to display the NFC Pairing dialog where you assign a user an NFC tag.
 - Tap  to display the Set PIN dialog where you assign the user a PIN to restrict access to the user account.
 - Tap  to display the Rename User dialog where you rename the user.
 - Tap  to delete a user.



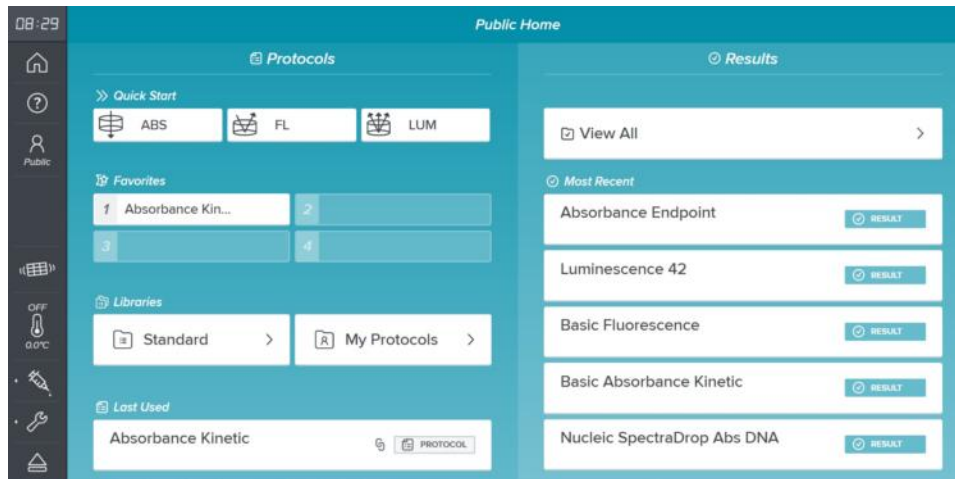

Note: Use the  in the icons on the left to log out, change your PIN, and return to the Welcome page. If you use an NFC tag, hold your tag over the NFC sensor below the touchscreen to change users.

The Home page displays your favorite protocols, your recent protocols, and your result information. From the Welcome page, tap a user to display the Home page. Your login credentials determine what protocol information displays. See [Welcome on page 30](#).



The following icons are added to the left side of the page:

-  - Return to your Home page.
-  - Change your PIN or log out. See [Changing PIN/Logout on page 36](#).

The Home page provides the following controls:

- **Quick Start** - Tap to start a new protocol or to quickly run a basic read that uses default settings. See [Quick Start and Favorites on page 37](#).
- **Favorites** - You can save four protocols as your favorite protocols to provide easy access from the Home page. See [Viewing Protocol Settings on page 55](#).
- **Libraries:** See [Protocol Libraries on page 38](#).
 - **Standard** - Tap to select from the protocols included with the instrument software.
 - **My Protocols** - Tap to select from the protocols you save for future use or to export your protocols for others to use or to use on a different instrument.
- **Last Used** - Tap to display the settings from your most recently used protocol. See [Viewing Protocol Settings on page 55](#).
- **View All** - Tap to view, manage, and export the read results in your Result Library. See [Result Library on page 71](#).
- The **Most Recent** list displays your most recent results with the date and time the read was run. Tap a result to display the read result details. See [Managing Results on page 72](#).

Changing PIN/Logout

Use the Change PIN/Logout dialog to change your PIN and to logout. The Change PIN option does not appear for users that do not have a PIN.



Note: If your account does not have a PIN and you want to add a PIN, use the Admin account to update your user account.

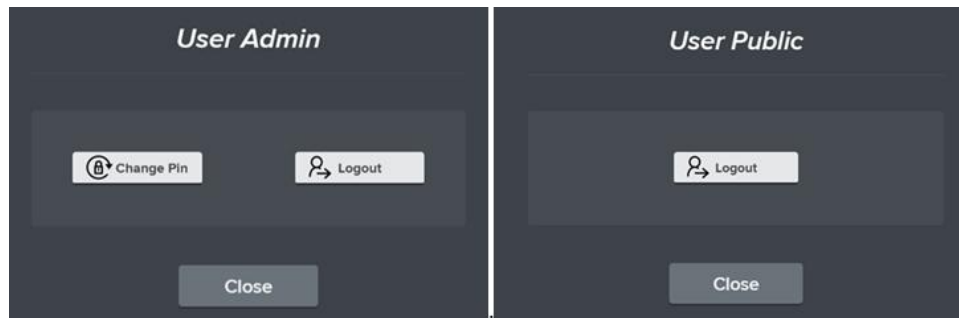

From the icons on the left, tap  to display the Change PIN/Logout dialog.

- Tap **Change PIN** to change your personal identification number.
- Tap **Logout** to logout of the instrument and return to the Welcome page.

Changing PIN

Use the Enter New PIN dialog to change the PIN that restricts access to your user account. If your account does not have an assigned PIN, the Admin user must update your account to add a PIN.

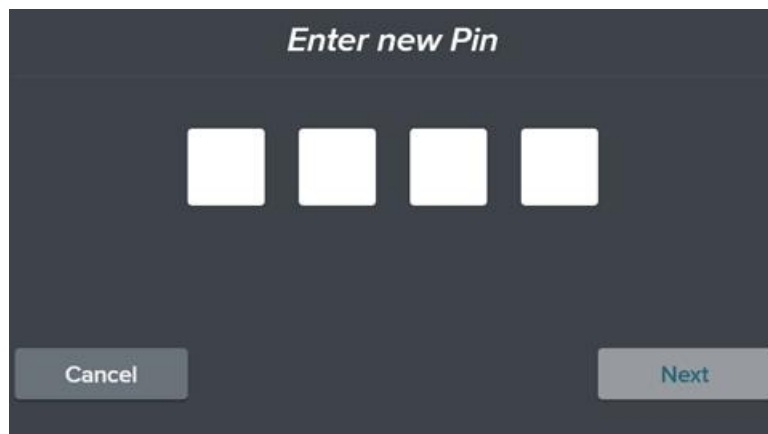

To change your PIN:

1. On the Welcome page, tap your user name.
2. Enter your PIN and tap **Login**.
3. From the icons on the left, tap  to display the Change PIN/Logout dialog.
4. Tap **Change PIN** to display the Enter New PIN dialog.
5. Enter your new four digit PIN and tap **Next** to display the Enter Old PIN dialog.
6. Enter your old PIN and tap **Save**.

Reset Admin PIN

If you forget the Admin user PIN, you can reset the Admin user PIN to the default 0000. The unlock code is the last four digits of the instrument serial number found on the Maintenance - System Information page and the sticker on the back of the instrument.

To reset the Admin PIN:

1. On the Welcome page, tap **Admin**.
2. Enter four digits and tap **Login** to display Reset PIN button.
3. Tap **Reset PIN** to display the Reset PIN dialog.
4. Enter the unlock code (last four digits of the instrument serial number) and tap **Reset**.





Note: The Admin user PIN is reset to the default 0000.

Quick Start and Favorites

The Home page provides Quick Start icons to allow you to quickly start to define protocol settings or to run a protocol that uses default settings. Default settings use the Endpoint read type for a 96-well plate, along with common settings for the read mode you tap. When you modify the protocol settings, you can save the new settings to your protocol library for future use.

Use the Favorites icons to run your favorite protocols. Use the Protocol Settings page to save a protocol as one of your favorites.

Tap the Quick Start icons or your Favorites to display the Protocol Settings page. See [Viewing Protocol Settings on page 55](#).

-  **ABS** - See [Absorbance Read Mode on page 79](#)
-  **FL** - See [Fluorescence Intensity Read Mode on page 83](#)
-  **LUM** - See [Luminescence Read Mode on page 87](#)

Protocol Libraries

Use the protocol libraries to access pre-defined protocol files that have settings but no data. The Home page provides access to the Standard library that contains the protocols included with the instrument software and the My Protocols library that contains the protocols you save. When you insert a USB drive into the USB port below the touchscreen, the Protocol Library includes an Import Protocols tab that allows you to import protocols created by a different user or created on a different instrument into your My Protocols library.

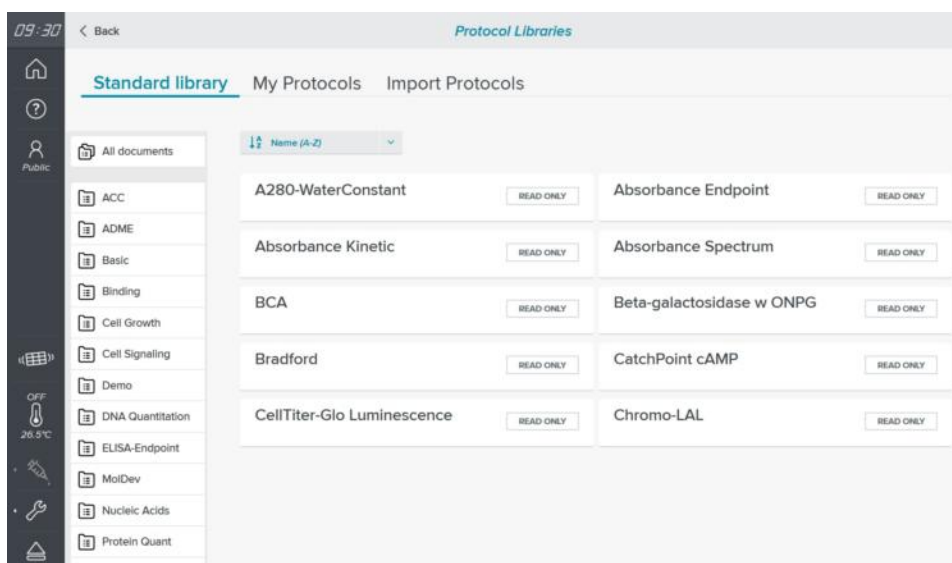

From the Home page, tap **Standard** or **My Protocols** to display the Protocol Libraries. After you access either protocol library, tabs allow you to navigate between the libraries.

There are two tabs on the Protocol Libraries page. When you insert a USB drive in the USB port below the touchscreen, an Import Protocols tab displays.

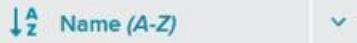
- Tap  to sort the protocols alphabetically or by date.
- Tap the page numbers below the list to display additional protocols.

Standard Library



Tap **Standard** above the protocol list to display the Standard library that contains pre-loaded protocols included with the instrument. The software organizes Standard library protocols in folders on the left. Tap a folder to display the protocols in the folder. The content of a folder can span several pages.

Standard library protocols are read only and are available to all users. You can run these protocols as they are defined or use them to help you create your own protocols that have similar settings. Tap the protocol to display its settings. You can then tap **Options** > **Save As** to save the protocol in your My Protocols library.

My Protocols Library

Tap **My Protocols** above the protocol list to display your My Protocols library that contains protocols associated to your user account. My Protocols protocols are only visible to you. You can add, export, copy, and delete your protocols.

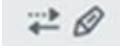
To manage the protocols in your My Protocol library:

- Tap a protocol to display the protocol settings. See [Viewing Protocol Settings on page 55](#).
- Tap  to add a protocol to your My Protocols library on the Create New Protocol dialog.
- Tap  for the following options to manage your My Protocols library list:
 - Select a protocol in the list and tap  to make a copy of the protocol.
 - Select one or more protocols in the list and tap  to export the protocol.



Note: You must insert a USB drive into the USB port below the touchscreen and/or synchronize the instrument with a computer that runs the QuickSync tool.

- Select one or more protocols in the list and tap  to delete the protocols you select.

Import Protocols

Use the Import Protocols tab on the Protocol Libraries page to import the protocols created by a different user or created on a different instrument into your My Protocols library.

To import protocols:

1. Insert a USB drive that contains the protocols you want to import into the USB port below the touchscreen to display a message.
2. On the message, tap **Import Protocols** to display the Import Protocols tab on the Protocol Libraries page. The Protocol Libraries caption changes to USB Storage.
3. Tap to select each protocol to import.
4. Tap  above the protocol list to import the protocols you select into your My Protocols library. Wait for the confirmation message to display.

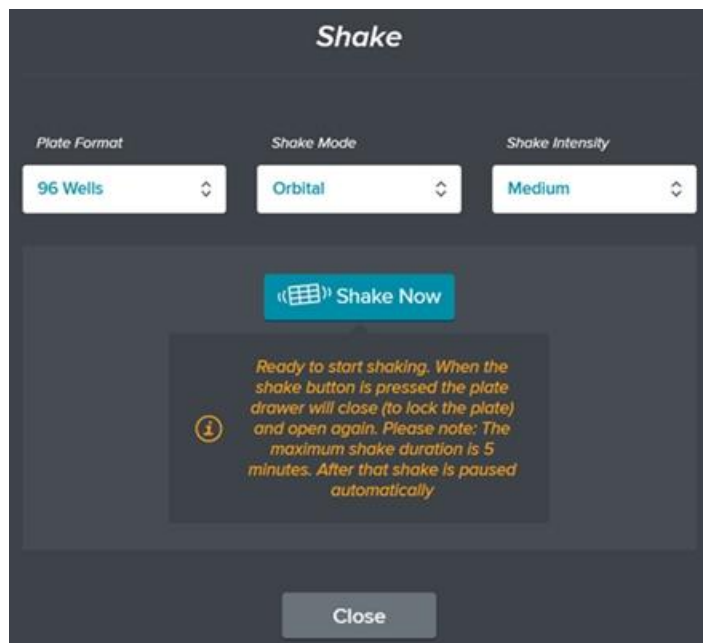

External Shake Settings

Use the external shake feature to shake a plate outside of the instrument. This shake process is independent of a protocol. When you create a protocol, the Settings page allows you to define how to shake the plate as part of the protocol. See [Defining Protocol Settings on page 57](#).



To shake a plate outside the instrument:

1. From the icons on the left, tap  to open the plate drawer and insert the plate.

 **Note:** Leave the plate drawer open.
2. From the icons on the left, tap  to display the Shake dialog.
3. Tap the **Plate Format** drop-down and select the number of wells the plate contains.
4. Tap the **Shake Mode** drop-down and select **Linear**, **Orbital** or **Double Orbital**.
5. Tap the **Shake Intensity** drop-down and select **Low**, **Medium**, or **High**.
6. Tap **Shake Now**. The Shake Now button changes to Pause.
 - The plate drawer closes to lock the plate and then opens again.
 - The plate shakes until you tap Pause or for five minutes. After five minutes the shake process stops. Tap Resume for a shake duration longer than five minutes.
7. To stop the shake, tap **Pause**. The Pause button changes to Resume.
8. Tap one of the following:
 - Tap **Resume** to start the shake again.
 - Tap **Close Drawer** to close the plate drawer to start a read.
 - Tap **Remove Plate** to remove the plate from the plate drawer.



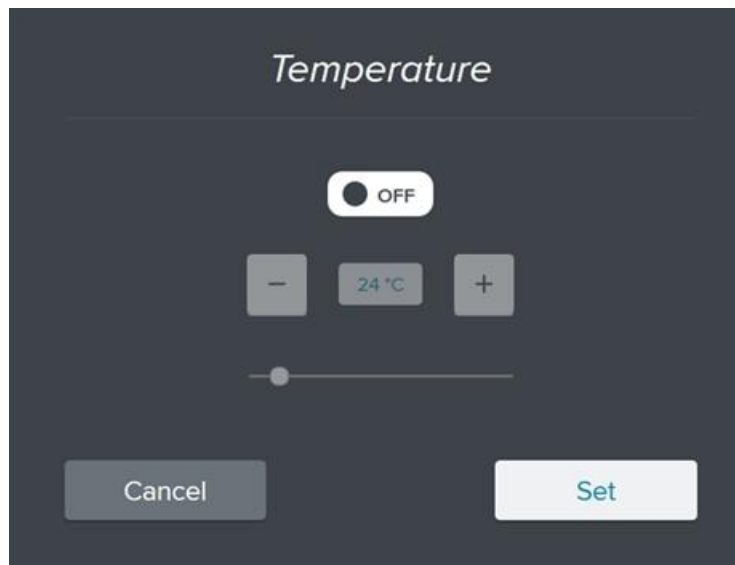

 **Note:** The plate drawer closes to release the lock then reopens to allow you to remove the plate.

Temperature Settings

The temperature inside the plate chamber can be maintained at 5°C (9°F) above ambient to 66°C (150.8°F). The temperature sensors detect the temperature of the air inside the chamber, not the temperature of the samples in the plate. If you use the instrument to warm, the samples, use a seal or lid on the plate to prevent evaporation of the sample. The seal or lid also helps to maintain a uniform temperature. It can take an hour or more for a prepared sample to equilibrate inside the plate chamber. You can speed up equilibration by pre-warming the sample and the assay reagents to the desired temperature before you place the plate in the chamber. Validate the data quality to determine whether the seal or lid can stay on the plate for the read.



To set the temperature of the plate chamber:

1. From the icons on the left, tap  to display the Temperature dialog.
2. Tap  to display  to activate the controls on the page.
3. Tap:
 -  - To granularly decrease the target temperature.
 -  - To granularly increase the target temperature.
 - The slider to broadly set the temperature.
4. Tap **Set**.

Maintaining Injectors

Use the Injector Maintenance page to wash, prime, and calibrate the injectors and to view the status of the amount of liquid that has been dispensed through the tubing to help you determine when to replace the tubing.

There are three tabs on the Injector Maintenance page:

- **Preparation** - Use this tab to wash and prime the injectors. See [Washing Injector Tubing on page 42](#) and [Priming Injector Tubing on page 45](#).
- **Calibration** - Use this tab to calibrate the injectors. See [Injector Calibration on page 49](#).
- **Tubing Change** - Use this tab to determine when to replace the injector tubing. See [Injector Tubing Status on page 51](#).



Note: You must use a computer running the SoftMax Pro Software to operate the instrument for advanced acquisition or injector protocols.

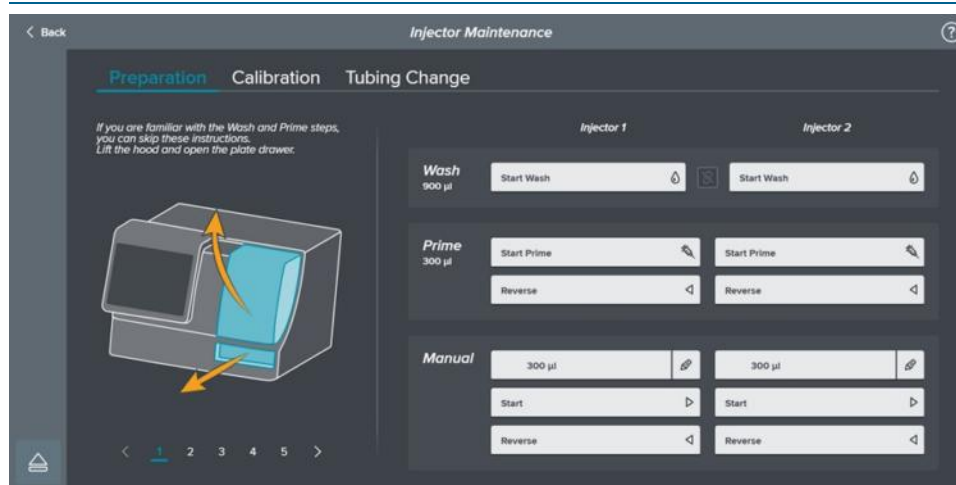

From the icons on the left, tap  to display the Preparations tab on the Injector Maintenance page. The Preparation tab displays several pages of instructions on the left.

Washing Injector Tubing

To ensure optimal operation of the injector, periodically wash the injector tubing. You should wash the injector tubing with deionized or distilled water for rinse cycles and 70% alcohol for a disinfectant cycle. You can configure the wash operation to dispense up to three solutions. For a list of compatible solutions, see [Compatible Solutions on page 110](#).



Note: You do not need to scroll through the instruction pages on the left to perform the wash and prime steps when you are familiar with the wash and prime procedures.

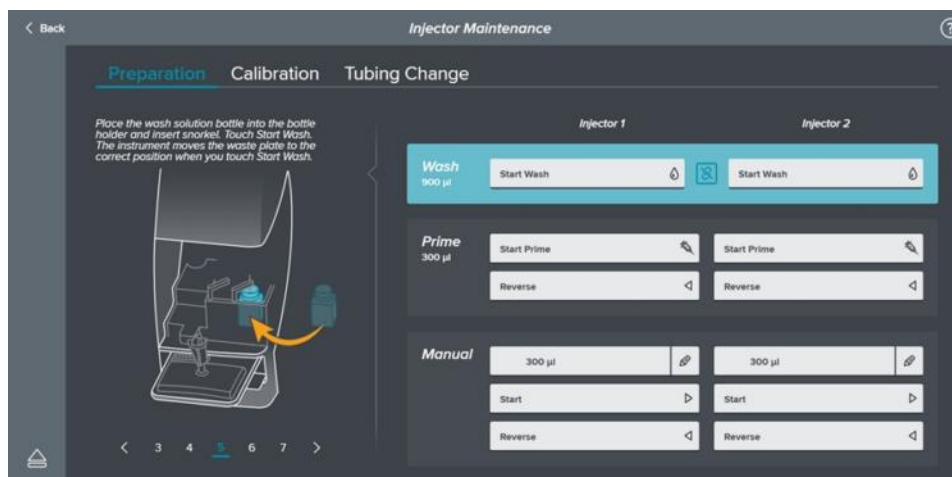

You can choose to use the predefined wash process that dispenses 900 µl or you can use the Manual section to define how much solution to dispense, to do reverse wash, and to do air aspiration steps.

During a wash or a read the nozzle that contains the injector tips lowers to 0.5 mm above the opening of the waste plate or the top of the plate to inject the reagent.



 **Tip:** Instead of switching the bottles in and out of the bottle holder between the solutions, you can put both snorkels into one bottle and run each solution through the tubing for both injectors at the same time.







To wash the injector tubing:

1. From the icons on the left, tap  to display the Injector Maintenance page. Tap the **Preparation** tab, if needed.
2. Use the handle to lift the instrument right hood.
3. Close the tube stabilizer lids over the injector pumps, if needed.
4. If reagent is still in the tubing, run a **Reverse** operation from the Prime settings or the Manual settings. See [Priming Injector Tubing on page 45](#).
Use the Manual settings to control the amount of liquid to move through the injector tubing for a wash or prime.
5. Tap  to open the plate drawer.
6. Insert an empty waste plate and empty strip wells on the plate carrier. See [Injector Waste Plate and Strip Wells on page 47](#).
7. Position the injector arm over the waste plate.



Note: The injector arm does not line up with the hole in the waste plate. The instrument moves the waste plate to the proper position when you tap Wash or Prime.

8. In the left rear area of the injector space, use the black knob to pull the nozzle straight up until the nozzle is free from the instrument. Then move the nozzle from the rear of the injector space to the injector arm.
9. Fill a bottle with enough solution for each injector tubing to wash and place the filled bottle in the left side of the bottle holder. See [Injector Bottles on page 48](#).
10. Fill another bottle with enough solution for each injector tubing to wash and place the filled bottle in the right side of the bottle holder.
If you use a third solution for the wash operation, fill a third bottle with enough solution for each injector tubing to wash and place the bottle to the side until the third wash step.
11. Place the snorkel for the injector to wash into the bottle on the left.
To wash the injector tubing for both injectors, place both snorkels in the bottle.

12. Tap:
 -  to simultaneously run both injectors for the wash.
 - **Start Wash** to dispense 900 µl for the wash.
 - **Manual**  to enter the amount of liquid to dispense then tap **Start**.
13. After the first wash step completes, move the snorkel or snorkels to the bottle on the right.
14. Tap:
 -  to simultaneously run both injectors for the wash.
 - **Start Wash** to dispense 900 µl for the wash.
 - **Manual**  to enter the amount of liquid to dispense then tap **Start**.
15. After the second wash step completes, remove one of the bottles and replace it with the third bottle. Move the snorkel or snorkels to the bottle that contains the third solution.
16. Tap:
 -  to simultaneously run both injectors for the wash.
 - **Start Wash** to dispense 900 µl for the wash.
 - **Manual**  to enter the amount of liquid to dispense then tap **Start**.
17. After the third wash step completes, empty the bottles and optionally return them to the bottle holder.
18. Return the snorkel for injector 1 to the left side snorkel clamp and the snorkel for injector 2 to the right side snorkel clamp.
19. Use the black knob to move the nozzle back to the rear of the injector space. Align the nozzle with the opening and press the nozzle straight down until you feel it snap into place.
20. Move the injector arm to its original position.
21. Remove the waste plate from the plate carrier and empty the contents to waste as prescribed by your laboratory procedures.
22. Tap  to close the plate drawer.

 **Tip:** When the injector is not in use and the tube is empty, open the tube stabilizer lid over the injector pump to extend the tubing lifetime.

Priming Injector Tubing



Before you run a read with the injectors, prime the injector tubing with the reagent that you use for the experiment.

You can use the predefined prime process that dispenses 300 μl or you can use the Manual section to define how much solution to dispense, to do reverse prime, and to do air aspiration steps.

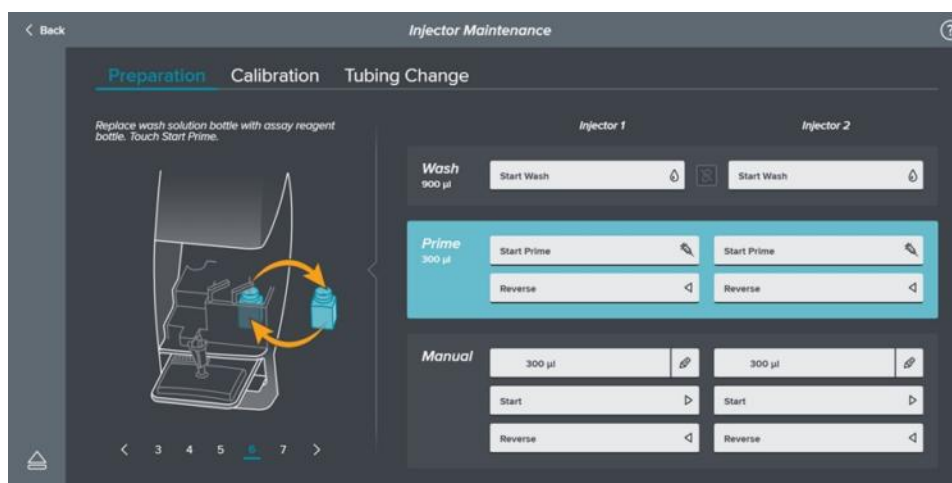
During a prime or a read the nozzle that contains the injector tips lowers to 0.5 mm above the opening of the waste plate or the top of the plate to inject the reagent.





To prime the injectors:

1. From the icons on the left, tap  to display the Injector Maintenance page. Tap the **Preparation** tab, if needed. Use the Manual settings to control the amount of liquid to move through the injector tubing for a wash or prime.
2. Use the handle to lift the instrument right hood.
3. Close the tube stabilizer lids over the injector pumps, if needed.
4. If reagent is still in the tubing, run a **Reverse** operation from the Prime settings or the Manual settings.
5. Tap  to open the plate drawer.
6. Insert the empty waste plate and the empty strip wells on the plate carrier. See [Injector Waste Plate and Strip Wells on page 47](#).
7. Position the injector arm over the waste plate.



Note: The injector arm does not line up with the hole in the waste plate. The instrument moves the waste plate to the proper position when you tap Wash or Prime.

8. In the left rear area of the injector space, use the black knob to pull the nozzle straight up until the nozzle is free from the instrument. Then move the nozzle from the rear of the injector space to the injector arm.

9. Fill the bottles with enough reagent for your experiment plus at least 2 mL to account for the prime operation and the quick-prime operation before the plate is read, and for the dead volume in the bottle and the tubing. Place the bottle for injector 1 on the left and the bottle for injector 2 on the right. See [Injector Bottles on page 48](#).
10. Place the left side snorkel for injector 1 into the bottle on the left and the right side snorkel for injector 2 into the bottle on the right.
11. Tap:
 - **Start Prime** for injector 1 to dispense 300 µl from the bottle on the left.
If the protocol uses both bottles, tap **Start Prime** for injector 2 after the first prime operation completes.
 - **Manual**  to enter the amount of liquid to dispense then tap **Start**.
12. Use the black knob to move the nozzle back to the rear of the injector space. Align the nozzle with the opening and press the nozzle straight down until you feel it snap into place.
13. Move the injector arm to its original position.
14. Remove the waste plate from the plate carrier and replace it with the prepared plate for your experiment.
15. Tap  to close the plate drawer.

Reverse

After you finish a read that uses the injectors, do a reverse prime to clear the reagent from the injector tubing and return it to the bottle. This can save valuable reagents from going to waste.

1. Tap  to open the plate drawer and remove the plate from the plate carrier, if applicable.
2. Insert the empty waste plate on the plate carrier.
3. Tap **Reverse** for each injector that has reagent in its tubing.
4. After you clear the injector tubes, you can remove the bottles from the instrument.

 **Tip:** When the injector is not in use and the tube is empty, open the tube stabilizer lid over the injector pump to extend the tubing lifetime.

Injector Waste Plate and Strip Wells

The waste plate captures excess liquid during the wash and prime operations. You use the strip wells during the quick-prime of the injectors that occurs when you start a read with injectors.



Note: Make sure that the waste plate and strip wells are empty before you insert them.



Tap  to open the plate drawer.

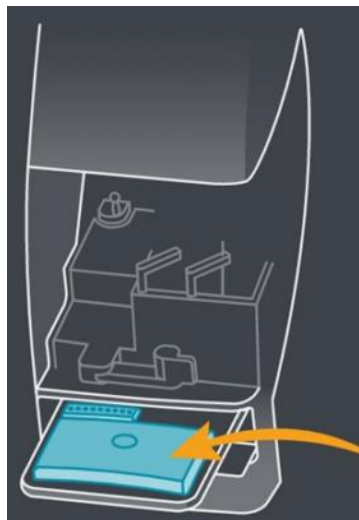

- Insert the empty waste plate in the same location as a plate.
- Insert the empty strip wells in the smaller slot next to the plate.



Note: The injector arm does not line up with the hole in the waste plate. The instrument moves the waste plate to the proper position when you tap Wash or Prime.

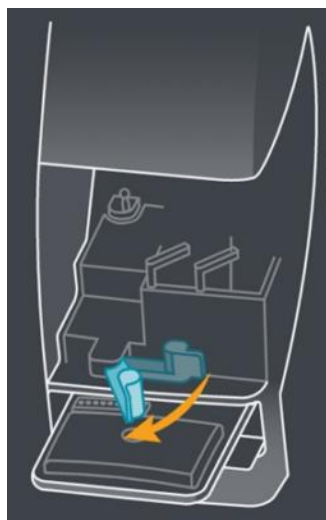

When you are ready to run an experiment, replace the waste plate with your prepared plate. The empty strip wells remain in the plate drawer for use during the 10 μ L quick-prime of the injectors when you start an injector read.

Injector Bottles

The bottle holder holds two bottles that correspond with the two injectors. Fill the bottles with enough reagent for your experiment plus at least 2 mL to account for the prime operation and the quick-prime operation that occur before the plate is read, and for the dead volume in the bottle and the tubing.

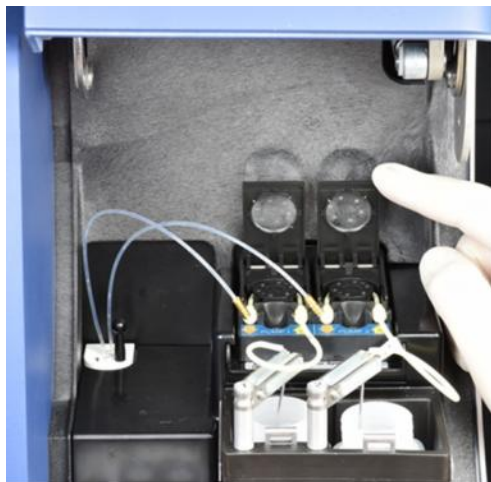

Place the bottle for injector 1 on the left and the bottle for injector 2 on the right. The injector comes with adapters that you can insert in the bottle holder to accommodate smaller labware. Each adapter has several hole positions, one for 1 mL tubes and others for larger vessels. Insert the adapters in the bottle holder before you insert the alternate labware. After you install the labware, insert the snorkels into the labware and secure the snorkels in the snorkel clamps.

To insert bottles in the bottle holder:

1. Use the handle to lift the instrument right hood.
2. Slide the snorkel tube out of the open side of the snorkel clamp and then slide it upward out of the bottle.

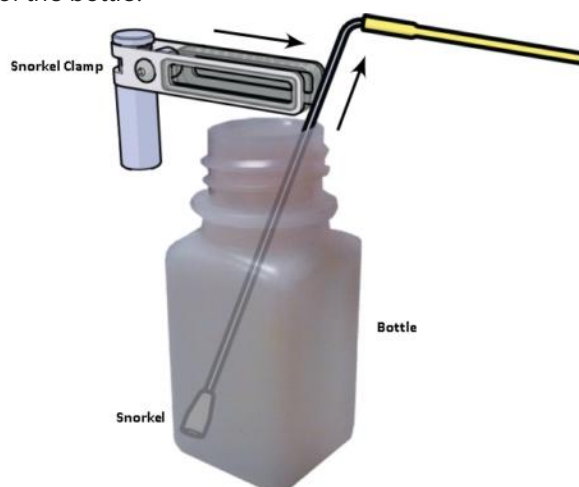

3. Twist the snorkel clamp to clear the position where the bottle is to be placed.
4. Remove the old bottle, if present, and then place the new bottle into its position.
5. Move the snorkel clamp back into position over the bottle.

- Slide the snorkel all the way down into the bottle and then slide the snorkel tube into the open end of the snorkel clamp.

The bottle holder is slightly tilted toward one corner. To extract the maximum amount of liquid from the bottle, place the end of the snorkel in the lowest point that is located in the corner of the bottle closest to the closed end of the snorkel clamp.



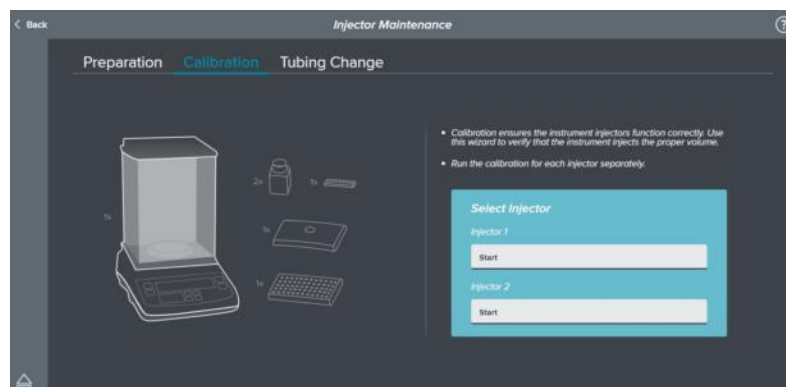

Injector Calibration

Use the Calibration tab on the Injector Maintenance page to calibrate the injector dispense volume. This workflow uses only the weight of the dispensed water. You may need to write down the weight of the plate and subtract that value from your entries when the scale is not exclusively available during calibration.















To calibrate the injectors:

- From the icons on the left, tap  to display the Injector Maintenance page. Tap the **Preparation** tab, if needed.
- Use the handle to lift the instrument right hood.
- Close the tube stabilizer lids over the injector pumps, if needed.
- If reagent is still in the tubing, run a **Reverse** operation in the Prime settings or the Manual settings. See [Priming Injector Tubing on page 45](#).
- Tap **Calibration** to display the first page of the Calibration wizard.
- In the Select Injector area, for injector 1, tap **Start**.
- Tap  to open the plate drawer.
- Place empty strip wells and an empty waste plate on the plate carrier. See [Injector Waste Plate and Strip Wells on page 47](#).

9. Position the injector arm over the waste plate.



Note: The injector arm does not line up with the hole in the waste plate. The instrument moves the waste plate to the proper position when you tap the Start buttons.

10. In the left rear area of the injector space, use the black knob to pull the nozzle straight up until the nozzle is free from the instrument. Then move the nozzle from the rear of the injector space to the injector arm.
11. Tap  to display the next page of the Calibration wizard.
12. Place two bottles, each filled with 50 ml distilled water, into the bottle holder.
13. Place the injector 1 snorkel in the bottle on the left and the snorkel for injector 2 in the bottle on the right.
14. Tap **Start Rinse** and wait for the rinse to finish.
15. Tap  to display the next page.
16. Use the black knob to move the nozzle back to the rear of the injector space and remove the waste plate.
17. Tap  to display the next page.
18. Use a scale to get the tare weight of a 96-well plate.
19. Tap  to display the next page.
20. Place the plate on the plate carrier.
21. Tap **Start Dispense** and wait for the dispense to complete.
22. Remove the plate from the carrier and weigh the plate with the first dispense liquid.
23. Tap the **Enter Weight**  and enter the weight of the dispensed liquid.
24. Tap  to display the next page.
25. Use a scale to get the tare weight of a 96-well plate.
26. Tap  to display the next page.
27. Place the plate on the plate carrier.
28. Tap **Start Dispense** and wait for the dispense to complete.
29. Remove the plate from the carrier and weigh the plate with the second dispense.
30. Tap the **Enter Weight**  and enter the weight of the dispensed liquid.
31. Tap  to display the next page.
32. Use a scale to get the tare weight of a 96-well plate.
33. Tap  to display the next page.
34. Place the plate on the plate carrier.
35. Tap **Start Verify** and wait for the verification dispense to complete.
36. Remove the plate from the carrier and weigh the plate with the verify dispense.
37. Tap the **Enter Weight**  and enter the weight of the dispensed liquid.
38. Tap .
 - If the weights are within the valid range the Calibration wizard steps are complete for injector 1.
 - If the weights are outside of the valid range, tap **Cancel** to enter a new weight or tap **Restart** to start the Calibration wizard again.

39. Repeat the steps in the Calibration wizard for injector 2.
40. After you complete the Calibration wizard for injector 2, remove the plate from the carrier, remove the snorkels from the bottles, remove the bottles from the bottle holder, tap  to close the plate drawer, lift the tube stabilizer lids over the injector pumps, and then close the instrument right hood.

Overfill Detection

An overfill detection sensor helps reduce the chance of spillage from dispensing too much liquid into a plate well. To avoid overfill errors, make sure that the dispense volume you define in the Manual section or the SoftMax Pro Software is less than the volume of the well minus the volume of the sample in the well. See the *SoftMax Pro Data Acquisition and Analysis Software User Guide* or the application help.

If an overfill detection error occurs, do the following:

- Clean the bottom of the injector. See [Cleaning Injectors and Accessories on page 92](#).
- Make sure the dispense volume you enter is less than the volume of the well minus the volume of the sample in the well.
- Make sure you specify the correct plate type and the plate definition is accurate.

Injector Tubing Status

The Tubing Change tab on the Injector Maintenance page display how many milliliters (ml) of liquid have been dispensed through the tubing. The lifetime of the tubing is limited and you must replace the tubing when worn.

The left side of the tab displays pages of instructions to change the tubing.

After you replace the tubing, tap **Reset Counter** to reset the counters to zero and then calibrate the injectors.

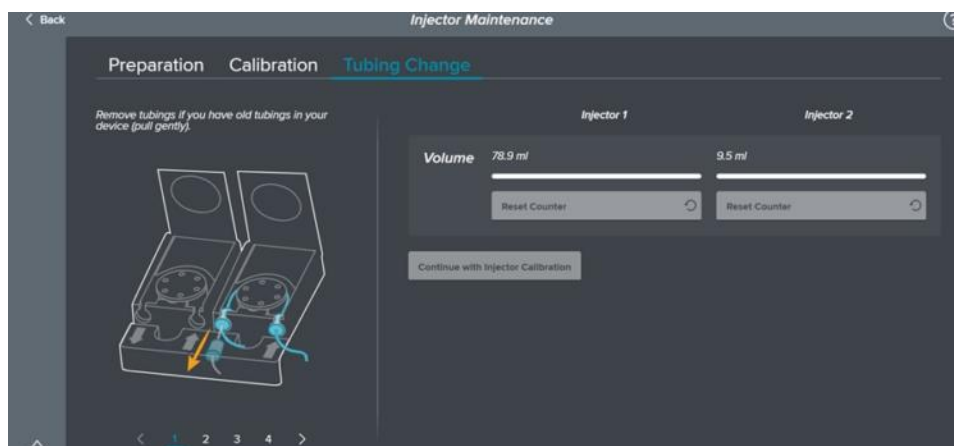

The SoftMax Pro Software displays messages as the dispensed volume reaches the following milestones:

- After 2000 ml have been dispensed through the tubing, a message appears to remind you that the tubing needs to be changed soon.
- After 3000 ml have been dispensed through the tubing, you must change the tubing before you can use the injectors.

Maintenance Page

All users can use the Maintenance page to view instrument information, manage reader settings, manage system settings, and to do support tasks.

The Admin user can use the Maintenance page to manage users.

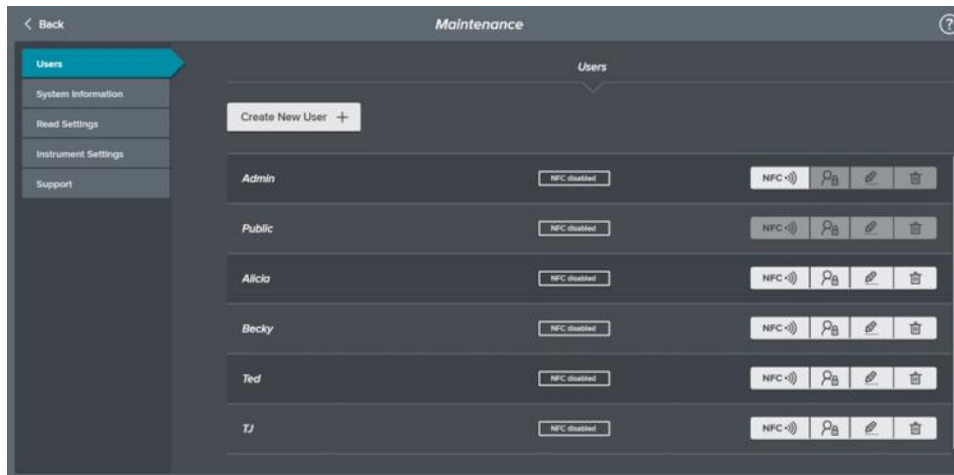

From the icons on the left, tap  to display the Maintenance page. The Maintenance page has the following tabs on the left:

- Tap **Users** to maintain the list of users. The Users tab is available only to the Admin user. The Admin user can add, rename, and delete users. This tab also allows the Admin user to assign user accounts a PIN and to associate user accounts with an NFC tag. See [Maintaining Users on page 33](#).
- Tap **System Information** to view the instrument serial number, storage used, assigned IP address, MAC address, instrument name, firmware version, PIC version, and software version. This information is useful for support purposes and when you want to get the instrument onto your network. See [Getting the Instrument on Your Network on page 32](#).
- Tap **Read Settings** to set preferences for protocol reads such as result export, check plate height, and auto plate eject. See [Defining Date, Time, and Global Read Settings on page 31](#).
- Tap **Instrument Settings** to adjust the brightness, volume, date format, and date/time. See [Defining Date, Time, and Global Read Settings on page 31](#).
- Tap **Support** to view how-to videos, access the log files that are useful for support purposes, and to set the transport slide in a position to accept the transport lock for shipment and storage. See [Obtaining Support on page 100](#).

Loading and Unloading Plates

The icons on the left include  to load or unload a plate:

1. Tap  to move the plate drawer outside of the instrument.
2. Place the plate onto the plate carrier or remove the plate from the plate carrier.



Note: Place the plate on the plate carrier in landscape orientation with well A1 in the left corner closest to the touchscreen.



3. Tap  to move the plate drawer inside the instrument.



CAUTION! To prevent damage to the instrument, the height of the plate must not exceed 22 mm, including the lid if the plate is lidded.



Protocols are experiment files that contain plate well layout assignments and reader configuration information, but no data. Protocol files allow you to repeat experiments without having to define the settings each time.

On the Home page, tap **ABS**, **FL**, or **LUM** to display the protocol settings page with the default settings that correspond to the read mode you tap. The Endpoint read type for a 96-well plate along with common read mode specific settings are the default settings. You can use the default settings or you can modify the settings and save the protocol in your My Protocols library. The protocols you save as your favorites also allow you to quickly run an experiment.

Tap **Standard** or **My Protocols** to select protocols stored in the file system.

Application notes with specific application protocol suggestions can be found in the Information Center and the Knowledge Base on the Molecular Devices web site at www.moleculardevices.com.

Viewing Protocol Settings

Use the protocol settings page to manage the name of the protocol file, to select the plate for which to define settings, and to start a read. Protocol settings for the plate you select display on the right.



Note: You must use a computer running the SoftMax Pro Software to operate the instrument for advanced acquisition or injector protocols.

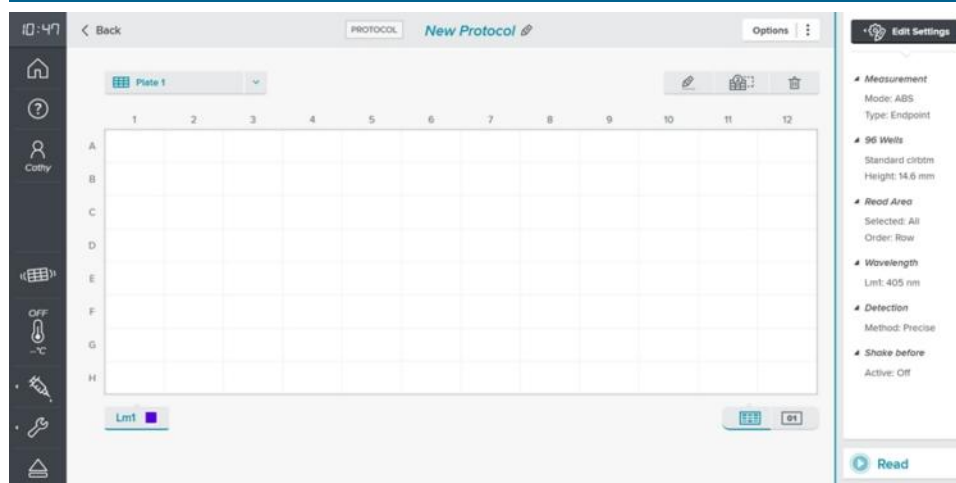







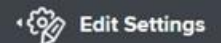





To view and manage protocol settings:

1. On the Home page, tap a quick start protocol or a favorite, or tap a protocol from the protocol libraries to display the protocol settings.



Note: Standard library protocols are read only. You can tap **Options > Save As** or  to save a copy of the Standard library protocol to your My Protocols library.



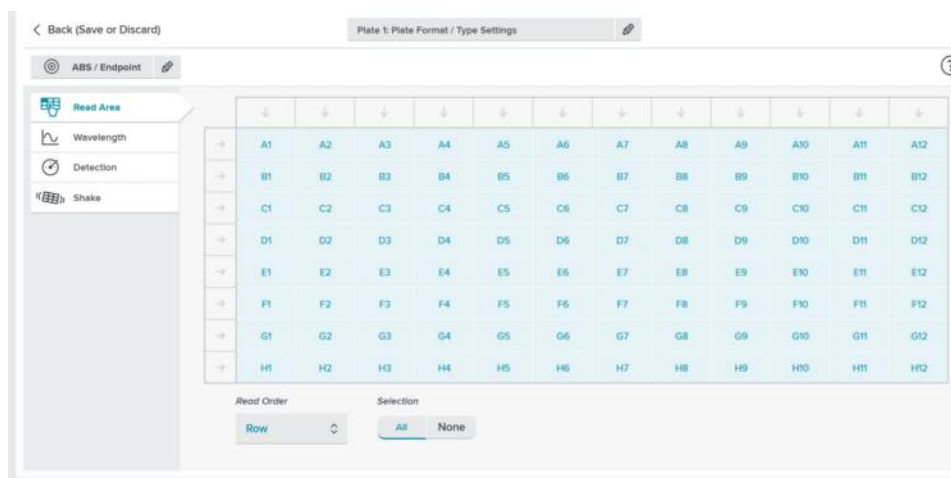

2. To name the protocol:
 - From the My Protocols library, tap  to display the Create New Protocol dialog.
 - From an existing protocol, tap **<protocol name>**  to rename the protocol on the Rename Protocol dialog.
 - Tap **Options** and tap **Save As** to create a copy of the protocol on the Save as New Protocol dialog.
3. The plate name ( **<plate name>** ) appears above the plate layout diagram. Use the following to define the plate format and type along with the read area etc. as part of the plate-specific protocol settings: See [Defining Protocol Settings on page 57](#).
 - Tap  **<plate name>**  and select the plate for which to define settings.
 - Tap  to change the name of the plate on the Rename Plate dialog.
 - Tap  to add a plate based on the Copy Plate dialog.
 - Tap  to delete the plate.
4. Settings for the plate you select appear on the right. Tap  **Edit Settings** to edit the plate-specific protocol settings. See [Defining Protocol Settings on page 57](#).
5. Tap **Options**:
 - Select **Save As** to change the protocol name.
 - Select **Export** to export the protocol to a USB drive or to the computers to which you synchronize the instrument. See [Exporting Result Data on page 75](#).
 - Select **Add to Favorites** to display the protocol in one of the four favorite protocol slots on your Home page. You can change the protocol name that appears as your favorite in this workflow, if needed.
6. Tap  **Read** to read the plate.
7. Tap  **<plate name>**  and select another plate to read, view, or manage the settings for any additional plates in the experiment.

Defining Protocol Settings

























Use the plate-specific settings page to define the settings for each plate in the protocol. Settings vary depending upon the read mode and read type you select.



Do the following for each plate in the protocol to define the plate format/plate type, read mode/read type, and other settings:

1. On the protocol settings page, tap  next to  <plate name>  and select the plate to define.
2. Tap  **Edit Settings** to define the plate settings and read settings for the plate you select.
3. The plate name appears at the top center of the page. Tap <plate name> **Plate Format/Type Settings**  to select the plate format and plate type on the Plate Settings dialog. See [Plate Format and Plate Type Settings on page 59](#).

4. The read mode and read type appear on the upper left side of the page. Tap **<read mode/read type>**  to select the read mode and read type in the Read Mode/Type dialog. See [Read Mode and Read Type Settings on page 60](#).

-  **ABS / Endpoint**  - Absorbance mode - Endpoint type
-  **ABS / Kinetic**  - Absorbance mode - Kinetic type
-  **ABS / Well Scan**  - Absorbance mode - Well Scan type
-  **ABS / Spectrum**  - Absorbance mode - Spectrum type
-  **FL / Endpoint**  - Fluorescence Intensity mode - Endpoint type
-  **FL / Kinetic**  - Fluorescence Intensity mode - Kinetic type
-  **FL / Well Scan**  - Fluorescence Intensity mode - Well Scan type
-  **FL / Spectrum**  - Fluorescence Intensity mode - Spectrum type
-  **LUM / Endpoint**  - Luminescence mode - Endpoint type
-  **LUM / Kinetic**  - Luminescence mode - Kinetic type
-  **LUM / Well Scan**  - Luminescence mode - Well Scan type
-  **LUM / Spectrum**  - Luminescence mode - Spectrum type

5. The **Read Area** tab displays for all read mode/read type combinations. Tap to select the wells to read. See [Read Area Settings on page 61](#).
6. The **Wavelength** tab displays for all read mode/read type combinations. Tap to define the wavelengths. See [Wavelength Settings on page 63](#).
7. The **Detection** tab displays for all read mode/read type combinations. Tap to define detection settings. See [Detection Settings on page 66](#).
8. The **Shake** tab displays for all read mode/read type combinations. Tap to define shake settings. See [Shake Settings on page 68](#).
9. The **Timing** tab displays for Kinetic read types. Tap to define the timing settings. See [Timing Settings on page 69](#).
10. The **Well Scan** tab displays for Well Scan read types. Tap to define well scan settings. See [Well Scan Settings on page 69](#).

Plate Format and Plate Type Settings

Depending on the application, the instrument can read 6, 12, 24, 48, 96, and 384-well plates and strip wells. For micro-volume measurements, the instrument supports SpectraDrop 24-well Micro-Volume Microplates and SpectraDrop 64-well Micro-Volume Microplates.

To read optical density at wavelengths below 340 nm, special UV-transparent, disposable, or quartz plates that permit transmission of the far UV spectra must be used.

To read cuvettes, the instrument supports the use of the SpectraCuvette™ adapter that has the 22 mm plate height sticker.



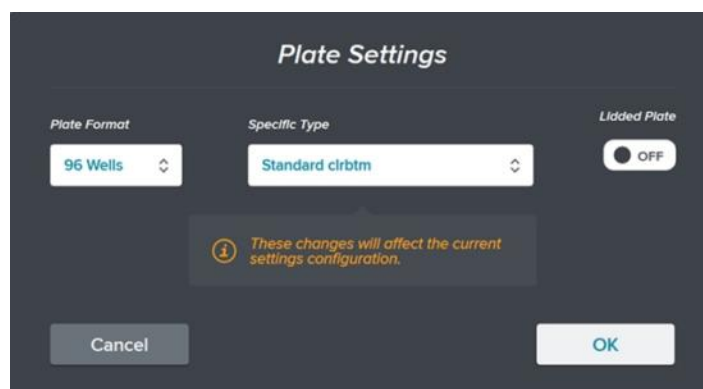

CAUTION! SpectraCuvette Adapters without a sticker have a plate height of 24 mm and cannot be used in the SpectraMax iD3 or SpectraMax iD5. To prevent damage to the instrument, the height of the plate must not exceed 22 mm, including the lid if the plate is lidded.

Use the Plate Settings dialog to select the plate format and plate type. Changes you make here affect the other protocol settings. See [Defining Protocol Settings on page 57](#).



To define the plate settings:

1. On the plate-specific settings page, tap **<plate name>**  to display the Plate Settings dialog.
2. Tap the **Plate Format** drop-down and select the number of wells in the plate.
3. Tap the **Specific Type** drop-down and select the plate type.
4. Tap the **Lidded Plate**  to display  if the plate has a lid.

The type of plate and the way it is handled can have an effect on the measurement performance of the instrument. Select a plate type with properties suited for the application.

- Never touch the clear well bottom of plates.
- Visually inspect the bottom and the rim of the plate before use to make sure that it is free of dirt and contaminants.
- Keep unused plates clean and dry.
- Make sure that the strips on strip plates are inserted correctly and level with the frame.
- Do not use V-bottom plates unless the performance has been tested and validated with this instrument. Irregular plastic density in the tip of the well can cause inaccurate measurements.

Read Mode and Read Type Settings

Use the Read Mode/Type dialog to set the protocol read mode and read type. After you select the read mode and read type on this dialog, the read mode/type displays at the top left on the plate-specific settings page. Any changes you make here affect the other protocol settings. See [Viewing Protocol Settings on page 55](#).





For a description of the supported read modes and read types, see [Read Modes and Read Types on page 77](#).

To set the protocol read mode and read type:





1. On the plate-specific settings page, tap  **ABS / Endpoint**  to display the Read Mode/Type dialog.



Note: The icon changes depending upon the read mode and read type. This example is for an Absorbance read mode, Endpoint read type.

2. Tap a read mode.
 -  - Absorbance
 -  - Fluorescence
 -  - Luminescence

3. Tap a read type.

-  - Endpoint
-  - Kinetic
-  - Well Scan
-  - Spectrum

Read Area Settings

Use the plate-specific settings page to define the read area. All read mode read type combinations have a Read Area tab on the left to allow you to define which wells on the plate to read.

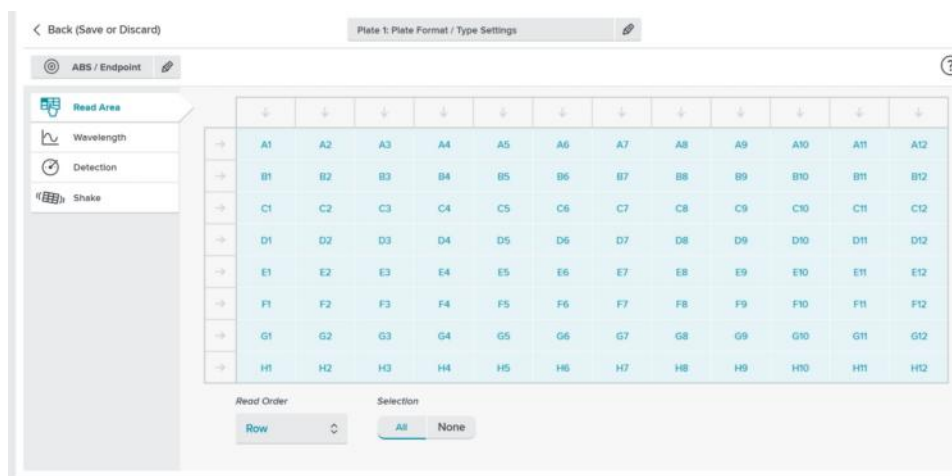

Your plate format selection adjusts the display of the Read Area tab.

You can choose to read an entire plate or a subset of wells. Columns do not need to start with column one. Wells in the read area that display a shaded background and the well number will be read.

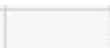
-  - Well read
-  - Well not read

To define which wells on the plate to read:

1. Start at the bottom of the tab. Select a **Read Order**:
 - Select **Row** to read each row in sequence.
 - Select **Column** to read each column in sequence.
 - Select **Well** to read each well individually with all wavelengths and intervals defined for the read before the next well is read.
2. Select a **Selection** option:
 - Select **All** to read all wells, then do the following to de-select the wells to not read.
 - Select **None** to read only well A1, then do the following to select additional wells to read.
3. Tap the following to select/de-select wells:



- - Tap to select all wells in a row. If all wells in the row are selected, this de-selects the entire row.



- - Tap to select all wells in a column. If all wells in the column are selected, this de-selects the entire column.
- Tap individual wells to select/de-select the well.
- To select a section of a plate:

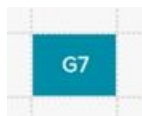

- Long tap (tap and hold) the well in the corner of the area to select until the well turns dark blue.
- Tap the well in the opposite corner. All wells in between appear selected/de-selected.

Wavelength Settings

Use the plate-specific settings page to define the wavelength. All read mode read type combinations have a Wavelength tab on the left that allows you to define which wavelengths to use for the plate read.

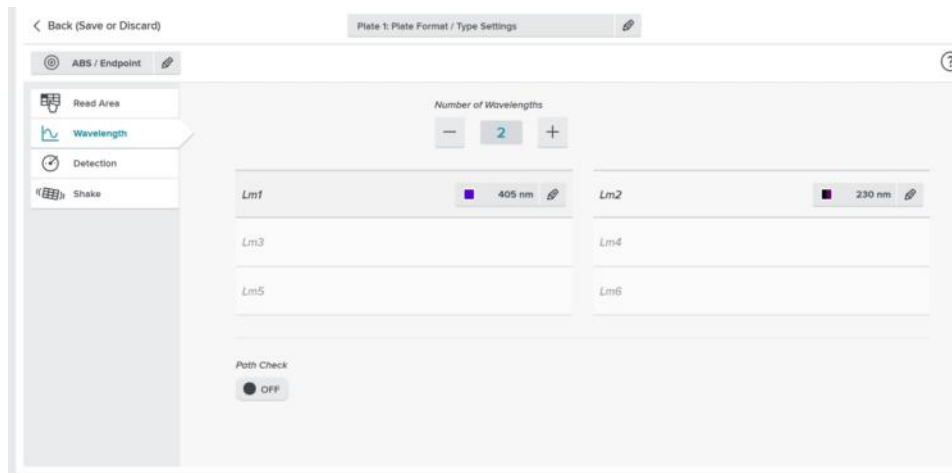



The read mode and read type setting determines which wavelength settings are applicable.

Absorbance Mode Wavelength

Absorbance - Endpoint

Wavelength settings for the Absorbance mode with the Endpoint type:

1. Tap the **Number of Wavelengths** $-$ or $+$ to define up to six wavelengths.
2. Tap  for each wavelength and enter the wavelength value. The wavelength range can be set from 230 - 1000 nm.
3. Tap the **Path Check**  to display  to use PathCheck® technology. The temperature-independent PathCheck Pathlength Measurement Technology normalizes your absorbance values to a 1 cm path length based on the near-infrared absorbance of water. See [PathCheck Technology on page 80](#).

Absorbance - Kinetic

Wavelength settings for the Absorbance mode with the Kinetic type:

1. Tap the **Number of Wavelengths** $-$ or $+$ to define up to six wavelengths.
2. Tap  for each wavelength and enter the wavelength value. The wavelength range can be set from 230 - 1000 nm.



Absorbance - Well Scan

Wavelength settings for the Absorbance mode with the Well Scan type:

1. Tap  and enter the wavelength value. The wavelength range can be set from 230 - 1000 nm.





Absorbance - Spectrum

Wavelength settings for the Absorbance mode with the Spectrum type: (Start and stop range from 230 - 1000 nm.)

1. Tap the **Start**  and enter the excitation start wavelength.
2. Tap the **Stop**  and enter the stop wavelength value.
3. Tap the **Step**  and enter the step wavelength increment between reads.



Fluorescence Mode Wavelength**Fluorescence - Endpoint and Kinetic**

Wavelength settings for the Fluorescence mode with the Endpoint and Kinetic types:

1. Tap the **Number of Wavelength Pairs**  or  to define up to four wavelength pairs.
2. Tap each **Excitation**  and enter each excitation wavelength.
3. Tap each **Emission**  and enter each emission wavelength.





Fluorescence - Well Scan

Wavelength settings for the Fluorescence mode with the Well Scan type:

1. Tap the **Excitation**  and enter the excitation wavelength.
2. Tap the **Emission**  and enter the emission wavelength.

Fluorescence - Spectrum

Wavelength settings for the Fluorescence mode with the Spectrum type:





1. Tap  to change between:
 - **Excitation Scan** where you define a fixed emission wavelength and sweep an excitation wavelength range.
 - **Emission Scan** where you define a fixed excitation wavelength and sweep an emission wavelength range.
2. For the sweep wavelengths, tap **Start**  and enter the start wavelength, tap **Stop**  and enter the stop wavelength. Then tap the **Step**  and enter the step increment between reads.
3. For the fixed wavelength, tap  and enter the **Excitation** or **Emission** wavelength.

Luminescence Mode Wavelength**Luminescence - Endpoint and Kinetic**

Wavelength settings for the Luminescence mode with the Endpoint and Kinetic types:

Set the **All Wavelength**  to use all wavelengths.

OR



1. Set the **All Wavelength**  to define wavelength settings.
2. Tap the **Number of Wavelengths**  or  to define up to four wavelengths.
3. Tap  for each wavelength and enter the wavelength value.

Luminescence - Well Scan

Wavelength settings for the Luminescence mode with the Well Scan type:



Set the **All Wavelength**  to use all wavelengths.

OR

1. Set the **All Wavelength**  to define wavelength settings.
2. Tap the wavelength  and enter the wavelength value.

Luminescence - Spectrum

Wavelength settings for the Luminescence mode with the Spectrum type:

1. Tap the **Start**  and enter the start emission wavelength value.
2. Tap the **Stop**  and enter the stop wavelength value.
3. Tap the **Step**  and enter the increment value.

Detection Settings

Use the plate-specific settings page to define the detection settings. All read mode read type combinations have a Detection tab on the left.



The read mode setting determines which detection settings are applicable.

Absorbance Mode Detection Settings

For the Absorbance read mode, there are two plate detection speeds:

- **Precise** - The instrument stops above each selected well and does the read. This provides more precise results than the Fast mode for demanding assays.
- **Fast** - The instrument continually moves the plate and the read is timed to occur when the plate reaches the read position.

The following table compares the read time for different plate types in each detection speed. These read times do not include the time needed for the plate drawer to move the plate into the instrument and start the read, and then move the plate out of the instrument, which can add approximately 25 seconds to the overall read time.

Plate Read Times (± 5 seconds)





Mode	96-Well	384-Well
Precise - Optimized for performance	28 seconds	45 seconds
Fast - Optimized for speed	20 seconds	33 seconds

Select a **Read Method**:

- Select **Precise** to use a slightly slower more precise detection method.
- Select **Fast** to use a faster less precise detection method.

Fluorescence Mode Detection Settings

Detection settings for the Fluorescence read mode:



1. Tap the **PMT Gain** drop-down:
 - Select **Auto** to have the instrument adjust the PMT voltage automatically for varying concentrations of samples in the plate (not available for Kinetic type).
 - Select **High** for samples that have lower concentration (dim samples).
 - Select **Medium** for samples that have average concentration.
 - Select **Low** for samples that have higher concentration (bright samples). If you select Low, tap the **Attenuation** drop-down and select an Optical Density between **0** and **3**.
2. **Read From Bottom**:
 - Set **Read From Bottom**  to read the plate down from above. Tap the **Read Height**  and enter the distance between the objective lens and the plate in millimeters.
 - Set **Read From Bottom**  to read the plate up from below rather than down from above.
3. Tap the **Integration Time**  and enter the integration time in milliseconds.



Note: Integration time is the interval to allow the instrument to acquire information per each flash.

Luminescence Mode Detection Settings

Detection settings for the Luminescence read mode:

1. Tap the **Read Height**  and enter the distance between the objective lens and the plate in millimeters.
2. Tap the **Integration Time**  and enter the integration time in milliseconds.



Note: Integration time is the interval to allow the instrument to acquire information per each flash.

Shake Settings

Use the plate-specific settings page to define the plate shake settings. All read mode read type combinations have a Shake tab on the left.

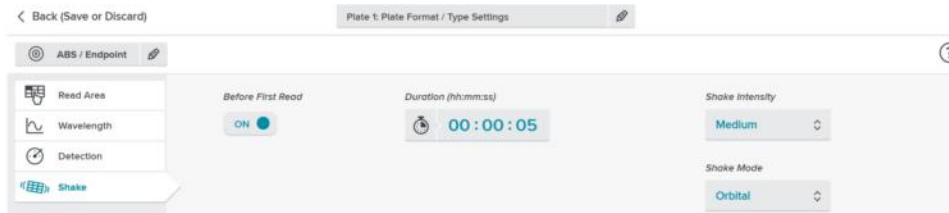

To define how to shake the plate:

Set **Before First Read** OFF to not shake the plate as a part of the read.

OR

1. Set **Before First Read** ON to shake the plate before the first read.
2. Tap the **Duration** field and then use the scroll bars to set the number of minutes and seconds to shake the plate.
3. Tap **Shake Intensity** and select **Low**, **Medium**, or **High**.
4. Tap **Shake Mode** and select **Linear**, **Orbital**, or **Double Orbital**.
5. For Kinetic read types:
 - Set **Between Reads** OFF to not shake the plate between reads. No other steps are required.
 - Set **Between Reads** ON and complete the following steps to define the shake duration between subsequent reads.
6. Tap the **Duration** field and then use the scroll bars to set the number of minutes and seconds to shake the plate.
7. Tap **Shake Intensity** and select **Low**, **Medium**, or **High**.
8. Tap **Shake Mode** and select **Linear**, **Orbital** or **Double Orbital**.

Timing Settings

For Kinetic read types, use the plate-specific settings page to define timing settings. All read mode Kinetic read types have a Timing tab on the left.

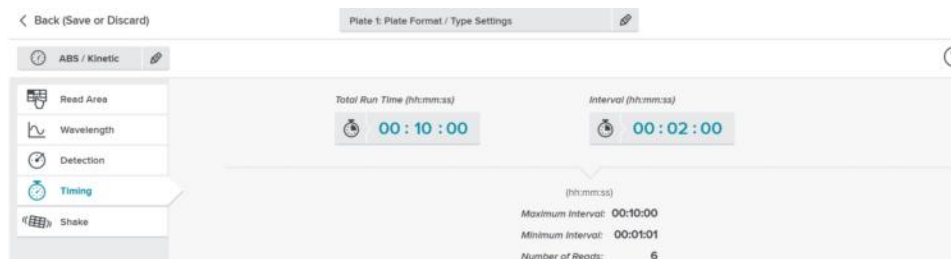

The instrument calculates the number of reads based on the value you enter for the Total Run Time and the Interval. The maximum total run time is 72 hours when you use the touchscreen. You can set longer run times when you use the SoftMax Pro Software.

To define the total run time and interval for Kinetic read types.



1. Tap the **Total Run Time** field and then use the scroll bars to set the total run time hours, minutes, and seconds. If you select Well on the Read Area tab, the maximum Total Read Time is 10 minutes.
2. Tap the **Interval** field and then use the scroll bars to set the interval hours, minutes, and seconds. If you select Well on the Read Area tab, the maximum Interval is 600 seconds and you can set the time down to the millisecond. Interval cannot be greater than Total Run Time.

Well Scan Settings

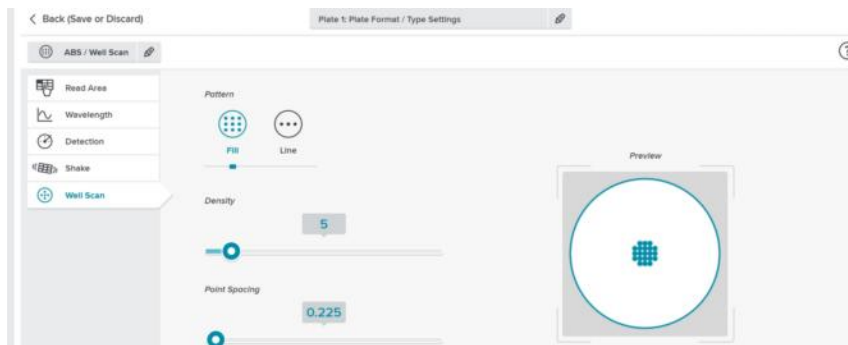
For Well Scan read types, use the plate-specific settings page to define from where in the well to take readings. All read mode Well Scan read types have a Well Scan tab on the left.



To define the well scan pattern, density, and point spacing.

1. Select a Pattern:
 -  - Tap for a fill pattern.
 -  - Tap for a horizontal line pattern.
2. Tap the **Density** slide to set the read density.
3. Tap the **Point Spacing** slide to set the point spacing.
4. View the **Preview** display.

Read

After you define the protocol settings for your read, tap  **Read** to display a status bar.

When you log in to the instrument as a user with PIN access, you can tap **Lock Screen** to prevent other users from interrupting your read. Users without a PIN and the Public user cannot lock the screen.



You and any other user can tap **Abort** or **Cancel** if there is a need to end the read.



After the read completes, the screen remains locked.



You can tap **Unlock Screen** and enter your PIN to unlock the screen and continue using the instrument.

Other users can tap **Logout** to log the user out, if needed.



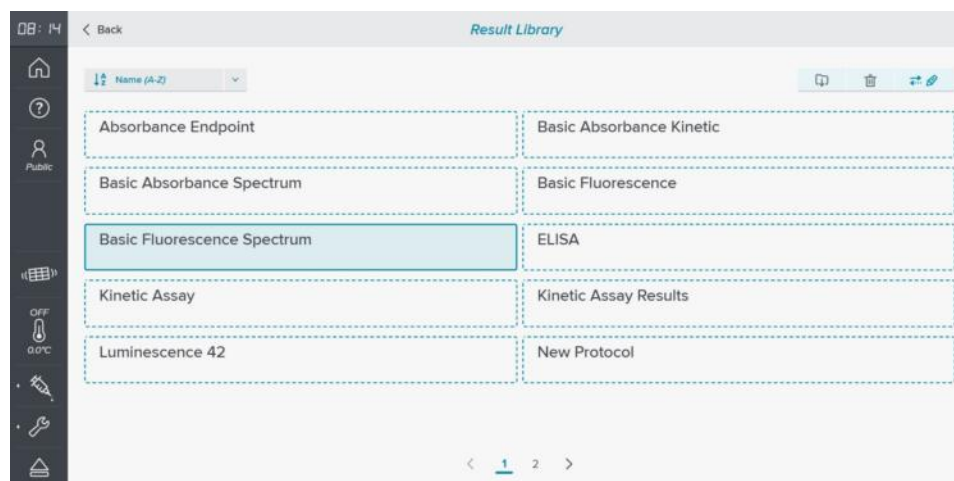

Result Library

The Result library displays the list of results for your reads.

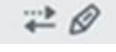

From the Results side of the Home page, tap **View All** to display the Result library. You can tap a result in your Most Recent results list to go directly to the Manage Results page. See [Managing Results on page 72](#).

To use the Result library:

- Tap  **Name (A-Z)**  to sort the results alphabetically or by date.
- Tap  to manage your results library:
 - Select one or more results in the list and tap  to export the protocol to a USB drive or to a computer over your intranet. See [Exporting Result Data on page 75](#).
 - Select one or more results in the list and tap  to delete the results you select.
- Tap a result to display the result details. See [Managing Results on page 72](#).

Endpoint Read Type Results

Depending on the read mode, Endpoint type raw absorbance, fluorescence, or luminescence data values are reported as optical density (OD), % Transmittance (%T), relative fluorescence units (RFU), or relative luminescence units (RLU).

Kinetic Read Type Results

Kinetic type results provide improved dynamic range, precision, and sensitivity relative to endpoint analysis. Raw data displays the change in optical density (OD), relative fluorescence units (RFU), or relative luminescence units (RLU) over time, displayed as a plot. The SoftMax Pro Software can do the following calculations based on raw data: VMax, VMax per Sec, Time to VMax, and Onset Time. Kinetic reads can be single wavelength or multiple wavelength reads.

Well Scan Read Type Results

Depending on the read mode, Well Scan type raw absorbance, fluorescence, or luminescence data values are reported as optical density (OD), % Transmittance (%T), relative fluorescence units (RFU), or relative luminescence units (RLU) that display as shades of blue to red in a heat map.

Spectrum Read Type Results











Depending on the read mode, a Spectrum type raw absorbance, fluorescence, or luminescence data displays optical density (OD), % Transmittance (%T), relative fluorescence units (RFU), or relative luminescence units (RLU) across a spectrum of wavelengths that display as a plot.

Managing Results

From the Result Library page or from your Most Recent results list, tap a result to display the raw data results of a read.

	1	2	3	4	5	6	7	8	9	10	11	12
A	2.202	3.868	1.290	2.675	1.489	3.088	3.728	2.024	2.775	1.044	1.950	0.537
B	3.023	0.956	2.324	3.048	3.344	3.221	3.823	0.913	3.463	0.483	1.656	1.231
C	1.696	3.868	2.420	0.930	0.771	2.729	0.863	1.851	2.331	3.764	2.445	1.639
D	2.030	1.011	3.402	2.155	2.770	1.053	3.442	2.294	3.768	1.036	1.062	0.270
E	3.436	0.975	3.250	3.381	0.946	0.936	3.214	1.630	2.232	0.087	0.979	1.181
F	0.647	2.797	1.852	3.976	0.201	3.299	2.226	3.258	1.310	0.685	1.017	2.232
G	2.498	0.687	1.403	2.370	1.341	3.361	1.462	0.660	2.806	2.270	1.434	3.196
H	3.439	1.482	0.904	1.283	0.930	2.005	3.426	1.943	0.032	1.821	1.488	3.912

To manage results:

- Tap **<result name>**  to rename the result. The Rename Result dialog displays.
- Tap **Options** then **Save As** to save the protocol settings in your My Protocols library, as a new protocol without result data, for future reads. The Save as New Protocol dialog displays.
- Tap **Options** then **Export** to export raw protocol data over your network or to a USB drive for further analysis.
- Tap  **<plate name>**  and select a plate to view the results for each plate in the experiment.
- Tap the following:
 - Tap  to change the plate name. The Rename Plate dialog displays.
 - Tap  to make a copy of the plate. The Copy Plate dialog displays.
 - Tap  to delete the plate.
- Pinch  the screen to zoom in or zoom out and swipe left or right as needed.
- Tap  to view the results for each wavelength.
- Tap  to view numeric results.
- Tap  to view heat map results.

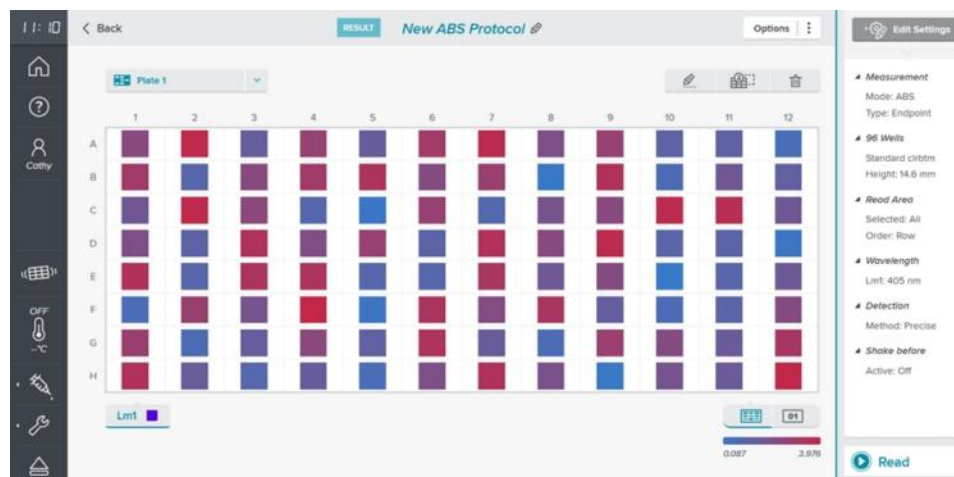

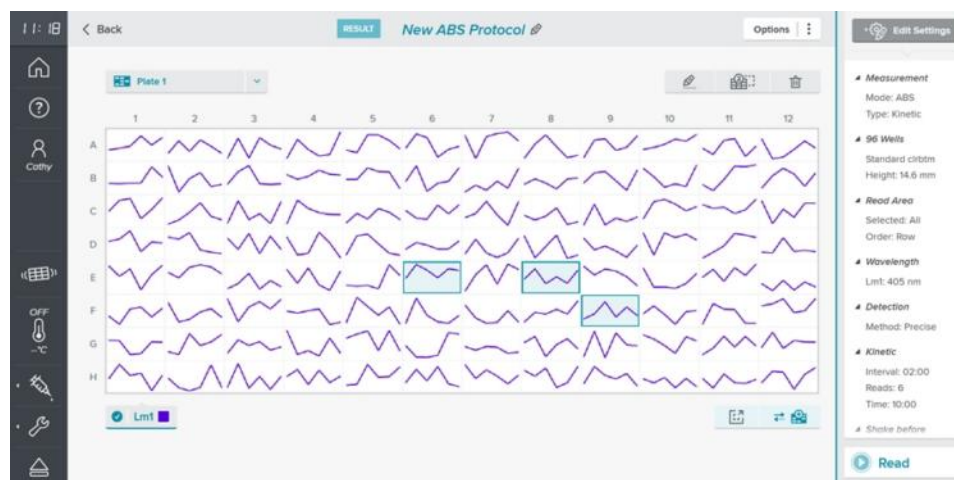

Compare Wells

Some results allow you to compare data in the wells.



To compare data in wells:

1. Tap  to compare the results in several wells. The icon spins and an additional icon appears.
2. Tap up to four wells to compare. Each well you select displays a shaded background.
3. Tap  to display the well comparison.

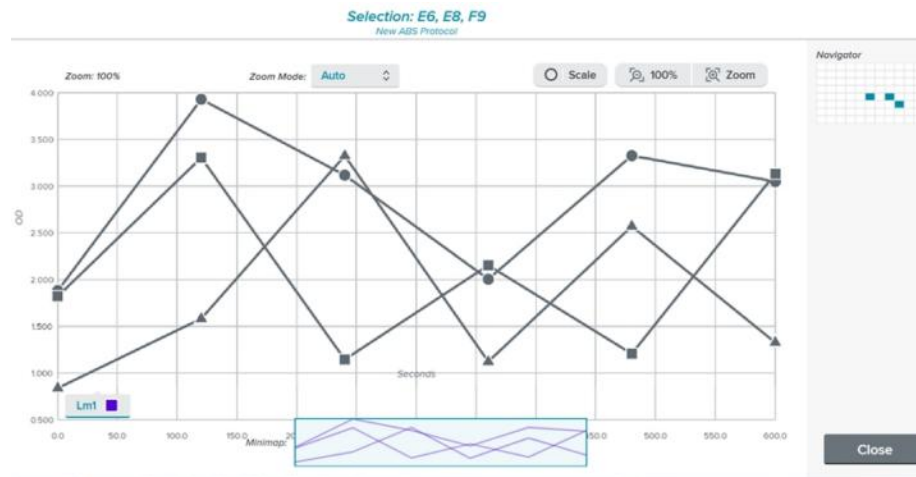

Well Specific Linear Results

Tap a single well in the result or select to compare multiple wells to display a view of a single well with the one result or the compared results.



The Navigator on the top right displays the well you select or the wells you select to compare. Tap the arrows below the Navigator to navigate the plate to view results in other wells.

For linear graph results:

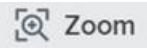
- Tap **Zoom Mode** and select:
 - **Auto** to use the Auto zoom mode.
 - **Ratio** to use the Ratio zoom mode.
 - **Horizontal** to zoom horizontally.
 - **Vertical** to zoom vertically.
- Pinch  the screen to zoom in and to zoom out.
- Tap  **Scale** to scale the image.
- Tap  **100%** to zoom to the original depth that displays for all wells in the result.
- Tap  **Zoom** to zoom to the depth where individual points become visible.



Use the mini map to orient what you view within the well after you zoom in.

Exporting Result Data

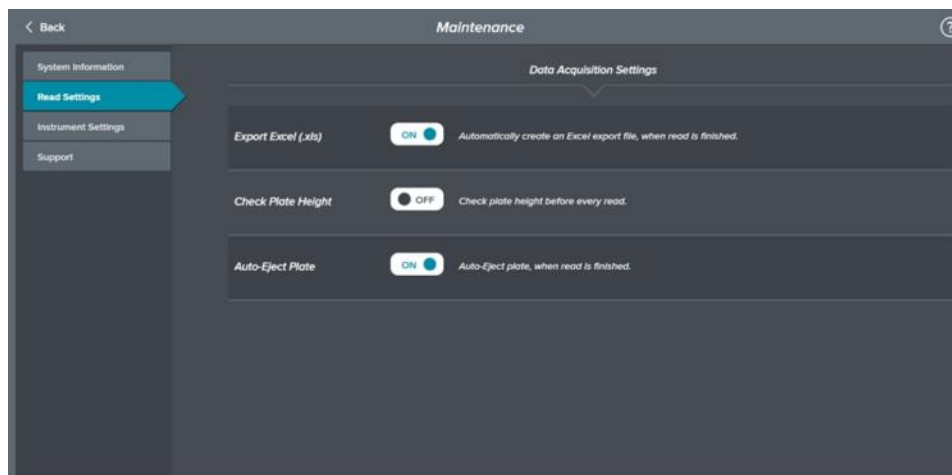
When you connect the instrument to your intranet or you connect the instrument directly to a computer with an Ethernet cable, you must install the QuickSync Tool on the computer to which you want to export data. See [Installing the QuickSync Tool on page 14](#).



The Read Settings tab on the Maintenance page provides an **Export Excel** option that allows the instrument to automatically export raw protocol data for further analysis.

1. From the icons on the left, tap  to display the Maintenance page.
2. Tap the **Read Settings** tab.
3. Tap the **Export Excel (.xls)**  to display  to export read results to an Excel format for further analysis.

If you operate the instrument from a computer running the SoftMax Pro Software, the touchscreen is disabled and all results appear in the SoftMax Pro Software. Remember to install the QuickSync Tool. See [Installing the QuickSync Tool on page 14](#).

You do not need to connect the instrument to your network or directly to a computer to export raw result data. When your instrument is not connected to your intranet or to a computer, leave the Maintenance - Reader Settings - Export Excel option to .

- Insert a USB drive into the USB port located below the front of the touchscreen.
- On the Result Manager page, tap **Options** then **Export** to export raw data to the USB drive.

 **Tip:** The file extension is .xml so you will need to open the Excel program on the computer and drag the file into an open Excel spreadsheet to view the data.

Using The QuickSync Tool



Use the QuickSync Tool to make the raw data the instrument exports available for further analysis.

This is optional. The steps in this topic are done on a computer, not on the instrument touchscreen.



Note: The microplate reader cannot have a USB drive in the USB slot below the touchscreen.

To use the QuickSync tool:

1. Use the instrument to run the read and leave the results displayed on the touchscreen.
2. On the computer running the QuickSync Tool, double-click the  on the desktop or in the task bar. A message appears that states "*QuickSync Ready!*"
3. Click ^ by the computer clock (Show Hidden Icons) to display a smaller version of the  in the computer tray.
4. Right-click  in the tray to display a menu and select **Available Services** to display the list of SpectraMax iD3 and SpectraMax iD5 instruments on your intranet and/or the instrument to which you connect the computer through an Ethernet cable.

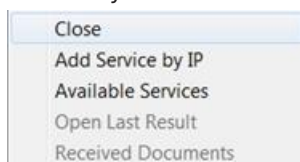

5. Click the name of instruments to which to synchronize the computer. A check mark appears next to each instrument name to which the computer is synchronized.

If the name of the instrument does not appear in the list of available services, right-click  and select **Add Service by IP** and enter the IP address of the instrument to which to connect.

6. On the upper left of the instrument touchscreen, tap **Export**. The computer running the SoftMax Pro Software displays a confirmation message.
7. On the computer running the SoftMax Pro Software, right-click  and select **Open Last Result**.
8. To copy single wavelength endpoint results from the QuickSync tool into the SoftMax Pro Software, you must have an entry in each well field. Enter **0** into any well that was not read.



Note: If a well result is saturated, the touchscreen displays #SAT.

The instrument can measure samples in Absorbance (ABS), Fluorescence Intensity (FL), and Luminescence (LUM) read modes. This chapter describes these read modes and their associated read types.

Application notes with specific application protocol suggestions can be found in the Information Center and the Knowledge Base on the Molecular Devices web site at www.moleculardevices.com.

Read Types

The touchscreen allows you to define the settings to achieve the expected results for the read mode using the Endpoint read type, Kinetic read type, Well Scan read type, and Spectrum read type.

Endpoint Read Type

In an Endpoint type, a read of each plate well is taken in the center of each well, at a single wavelength or at multiple wavelengths. Depending on the read mode, raw data values are reported as optical density (OD), % transmittance (%T), relative fluorescence units (RFU), or relative luminescence units (RLU).

Kinetic Read Type

In a Kinetic type, the instrument collects data over time with multiple reads taken in the center of each well at regular intervals.

The SoftMax Pro Software can do the following calculations based on raw data: VMax, VMax per Sec, Time to VMax, and Onset Time. Kinetic reads can be single wavelength or multiple wavelength reads.

The Kinetic type can collect data points in time intervals of seconds, minutes, or hours.

Kinetic analysis has many advantages to determine the relative activity of an enzyme in different types of plate assays, including ELISAs and the purification and characterization of enzymes and enzyme conjugates. Kinetic analysis is capable of providing improved dynamic range, precision, and sensitivity relative to endpoint analysis.

Spectrum Read Type

Spectrum type reads can measure across the spectrum of absorbance wavelengths 230 nm to 1000 nm. Fluorescent intensity reads scan excitation wavelengths between 250 nm to 830 nm and emission wavelengths between 270 nm to 850 nm, where the emission wavelength must be a minimum of 20 nm greater than the excitation wavelength. Luminescence reads scan emission wavelengths between 300 nm to 850 nm.

Depending on the read mode selected, a Spectrum read measures optical density (OD), %Transmittance (%T), relative fluorescence units (RFU), or relative luminescence units (RLU) across a spectrum of wavelengths.

Well Scan Read Type

A Well Scan type can read at more than one location within a well. A Well Scan read takes one or more reads of a single well of a plate on an evenly spaced grid inside of each well at single or multiple wavelengths.

Some applications involve the detection of whole cells in large-area tissue culture plates. Well Scan reads can be used with such plates to permit maximum surface area detection in whole-cell protocols. Since many cell lines tend to grow as clumps or in the corners of plate wells, you can choose from several patterns and define the number of points to be scanned to work best with your particular application.

The following scan patterns are available:

- A horizontal line
- A fill pattern

The fill pattern can be either round or square to match the shape of the well.

You can set the density of the well scan to determine the number of points to read in a line pattern or the maximum number of horizontal and vertical points included in a cross or fill pattern.

Depending on the read mode selected, the values are reported as optical density (OD), %Transmittance (%T), relative fluorescence units (RFU), or relative luminescence units (RLU).

Absorbance Read Mode

The instrument uses the Absorbance (ABS) read mode to measure the Optical Density (OD) of the sample solutions.

Absorbance is the quantity of light absorbed by a solution. To measure absorbance accurately, it is necessary to eliminate light scatter. If there is no turbidity, then absorbance = optical density.

$$A = \log_{10}(I_0 / I) = -\log_{10}(I/I_0)$$

where I_0 is intensity of the incident light before it enters the sample divided by the light after it passes through the sample, and A is the measured absorbance.

The temperature-independent PathCheck technology normalizes absorbance values to a 1 cm path length based on the near-infrared absorbance of water.

The instrument allows you to choose whether to display absorbance data as Optical Density (OD) or %Transmittance (%T).

Optical Density

Optical density (OD) is the quantity of light passing through a sample to a detector relative to the total quantity of light available. Optical Density includes absorbance of the sample plus light scatter from turbidity and background. You can compensate for background using blanks.

A blank well contains everything used with the sample wells except the chromophore and sample-specific compounds. Do not use an empty well for a blank.

Some applications are designed for turbid samples, such as algae or other micro-organisms in suspension. The reported OD values for turbid samples are likely to be different when read by different instruments.

For optimal results, you should run replicates for all blanks, controls, and samples. In this case, the blank value that will be subtracted is the average value of all blanks.

% Transmittance

%Transmittance is the ratio of transmitted light to the incident light for absorbance reads.

$$T = I/I_0$$

$$\%T = 100T$$

where I is the intensity of light after it passes through the sample and I_0 is incident light before it enters the sample.

Optical Density and %Transmittance are related by the following formulas:

$$\%T = 10^{2-OD}$$

$$OD = 2 - \log_{10}(\%T)$$

The factor of two comes from the fact that %T is expressed as a percent of the transmitted light and $\log_{10}(100) = 2$.

When in %Transmittance analysis mode, the instrument converts the raw OD values reported by the instrument to %Transmittance using the above formula. All subsequent calculations are done on the converted numbers.

Applications of Absorbance

Absorbance-based detection is commonly used to evaluate changes in color or turbidity, permitting widespread use including ELISAs, protein quantitation, endotoxin assays, and cytotoxicity assays. With absorbance readers that are capable of measuring in the ultraviolet (UV) range, the concentration of nucleic acids (DNA and RNA) can be found using their molar extinction coefficients.

For micro-volume measurements, you can use SpectraDrop 24-well Low Volume Microplate and SpectraDrop 64-well Low Volume Microplate.

PathCheck Technology

The temperature-independent PathCheck technology normalizes absorbance values to a 1 cm path length based on the near-infrared absorbance of water.

The Beer–Lambert law states that absorbance is proportional to the distance that light travels through the sample.

$$a - b = c d e + f$$

where a is absorbance, b is blank, c is concentration, d is the depth of sample layer, e is extinction (coefficient of...), and f is further terms, e.g., non-linearity caused from turbidity.

Microplate readers use a vertical light path so the distance of the light through the sample depends on the volume. This variable pathlength makes it difficult to do extinction-based assays and makes it confusing to compare results between microplate readers and spectrophotometers.

The standard pathlength of a 1 cm cuvette is the conventional basis to quantify the unique absorptivity properties of compounds in solution. Quantitative analysis can be done on the basis of extinction coefficients, without standard curves (for example, NADH-based enzyme assays). When you use a cuvette, the pathlength is known and is independent of sample volume, so absorbance is directly proportional to concentration when there is no background interference.

In a plate, pathlength is dependent on the liquid volume, so absorbance is proportional to both the concentration and the pathlength of the sample. Standard curves are often used to determine analyte concentrations in vertical-beam photometry of unknowns, yet errors can still occur from pipetting the samples and standards. The PathCheck technology determines the pathlength of aqueous samples in the plate and normalizes the absorbance in each well to a pathlength of 1 cm. This way of correcting the microwell absorbance values is accurate to within $\pm 4\%$ of the values obtained directly in a 1 cm cuvette.

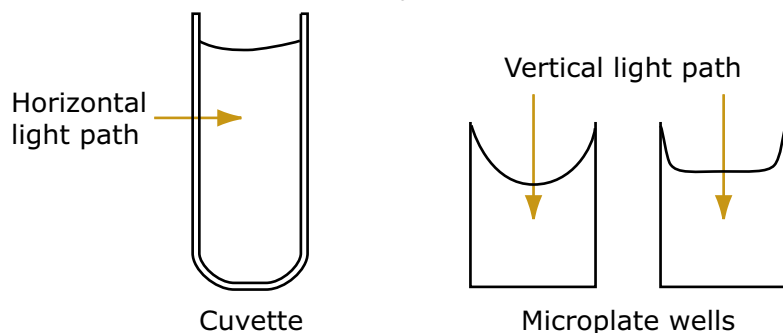

PathCheck technology normalizes the data acquired from an absorbance read mode endpoint read type to a 1 cm pathlength, correcting the OD for each well to the value expected if the sample were read in a 1 cm cuvette. The instrument uses the factory installed water constant to obtain the 1 cm values.



Note: You must select the PathCheck check box before a read because you cannot apply the PathCheck technology after the read. After you read a plate with PathCheck technology turned on, the software stores PathCheck information permanently within the document.

Water Constant

The PathCheck technology is based on the absorbance of water in the near infrared spectral region (between 900 nm and 1000 nm). If the sample is completely aqueous, has no turbidity and has a low salt concentration (less than 0.5 M), the water constant correction method is sufficient. The water constant is determined for each instrument during manufacture and is stored in the instrument.

Eliminating the Pathlength Independent Component

Raw OD measurements of plate samples include both pathlength-dependent components (sample and solvent) and a pathlength-independent component (OD of plate material). The pathlength-independent component must be eliminated from the calculation to get valid results that have been normalized by the PathCheck technology. You can do this using a plate blank or using a plate background constant.

Using a Plate Blank

You can use this method if all samples in the plate are the same volume and the read does not depend on the PathCheck technology to correct for variability in volumes.

To use a plate blank:

1. Designate a minimum of one well (preferably several) as Plate Blank.
2. Pipette buffer (for example, your sample matrix) into those wells and read along with the samples. Do not use an empty well for a blank.
The instrument automatically subtracts the average of the blank wells from each of the samples. The OD of the plate material is subtracted as part of the blank.
3. Select the Use Plate Blank check box in the Data Reduction dialog in the SoftMax Pro Software.

Using a Plate Background OD

If your sample volumes are not identical or if you choose not to use a Plate Blank, then you must use a Plate Background OD. Omitting a Plate Background OD results in artificially high values after being normalized by the PathCheck technology.

To determine the Plate Background OD:

1. Fill a clean plate with water.
2. Read at the wavelengths you will use for the samples.

The average OD value is the Plate Background OD. If you intend to read your samples at more than one wavelength, there should be a corresponding number of Plate Background OD values for each wavelength.



Note: It is important that you put water in the wells and do not read a dry plate for the Plate Background OD. A dry plate has a slightly higher OD value than a water filled plate because of differences in refractive indices. Use of a dry plate results in PathCheck technology normalized values that are lower than 1 cm cuvette values.

Interfering Substances

Material that absorbs in the 900 nm to 1000 nm spectral region could interfere with PathCheck technology measurements. Fortunately, there are few materials that do interfere at the concentrations generally used.

Turbidity is the most common interference. If you can detect turbidity in your sample, you should not use the PathCheck technology. Turbidity elevates the 900 nm measurement more than the 1000 nm measurement and causes an erroneously low estimate of pathlength. Use of the Cuvette Reference does not reliably correct for turbidity.

Samples that are highly colored in the upper-visible spectrum might have absorbance that extends into the near-infrared (NIR) spectrum and can interfere with the PathCheck technology. Examples include Lowry assays, molybdate-based assays, and samples that contain hemoglobins or porphyrins. In general, if the sample is distinctly red or purple, you should check for interference before you use the PathCheck technology.

To determine possible color interference:

- Measure the OD at 900 nm and 1000 nm (both measured with air reference).
- Subtract the 900 nm value from the 1000 nm value.

Do the same for pure water.

If the delta OD for the sample differs significantly from the delta OD for water, then you should not use the PathCheck technology.

Organic solvents could interfere with the PathCheck technology if the solvents have absorbance in the region of the NIR water peak. Solvents such as ethanol and methanol do not absorb in the NIR region, so the solvents do not interfere, except to cause a decrease in the water absorbance to the extent of their presence in the solution. If the solvent absorbs between 900 nm and 1000 nm, the interference would be similar to the interference of highly colored samples. If you add an organic solvent other than ethanol or methanol, you should run a Spectrum scan between 900 nm and 1000 nm to determine if the solvent would interfere with the PathCheck technology.

Fluorescence Intensity Read Mode

Fluorescence occurs when absorbed light is re-radiated at a longer wavelength. In the Fluorescence Intensity (FL) read mode, the instrument measures the intensity of the re-radiated light and expresses the result in Relative Fluorescence Units (RFU).

The governing equation for fluorescence is:

$$\text{Fluorescence} = \text{extinction coefficient} \times \text{concentration} \times \text{quantum yield} \times \text{excitation intensity} \times \text{pathlength} \times \text{emission collection efficiency}$$

Fluorescent materials absorb light energy of a characteristic wavelength (excitation), undergo an electronic state change, and instantaneously emit light of a longer wavelength (emission). Most common fluorescent materials have well-characterized excitation and emission spectra. The following figure shows an example of excitation and emission spectra for a fluorophore. The excitation and emission bands are each fairly broad with half-bandwidths of approximately 40 nm, and the difference between the wavelengths of the excitation and emission maxima (the Stokes shift) is generally fairly small, about 30 nm. There is considerable overlap between the excitation and emission spectra (gray area) when a small Stokes shift is present.

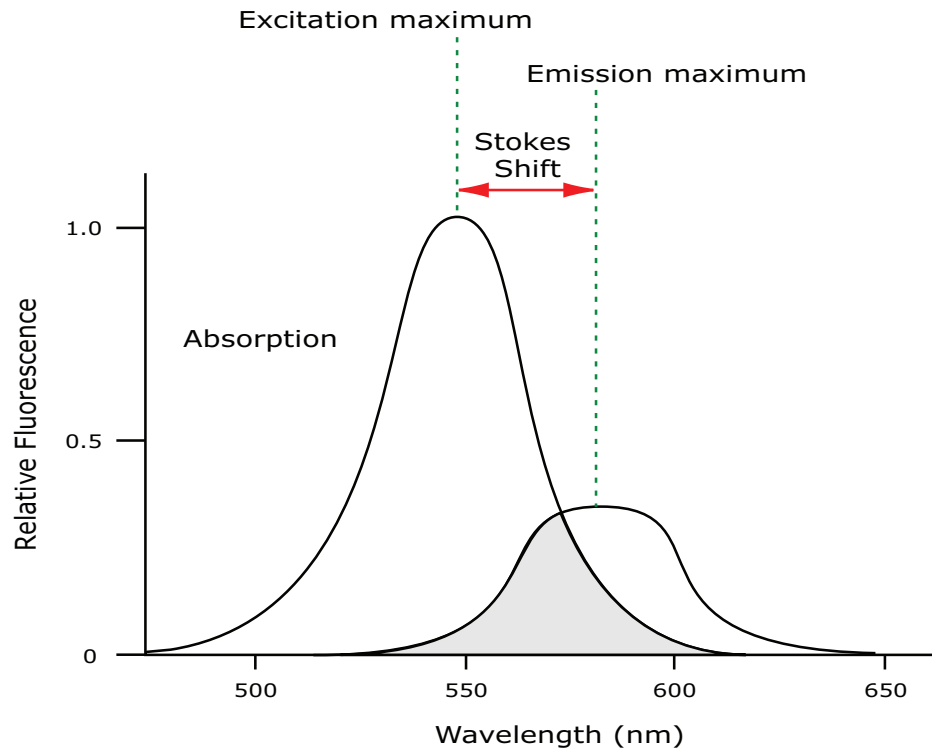

Excitation and Emission Spectra

Because the intensity of the excitation light is usually many tens of thousands of times greater than that of the emitted light, you must have sufficient spectral separation to reduce the interference of the excitation light with detection of the emitted light.

*** Tip:** If the Stokes shift is small, you should choose an excitation wavelength that is as far away from the emission maximum as possible while still able to stimulate the fluorophore so that less of the excited light overlaps the emission spectrum, which permits better selection and quantitation of the emitted light.

The Spectral Optimization wizard in the SoftMax Pro Software provides the best method to maximize the signal to background window (S-B)/B while minimizing the optimization time.

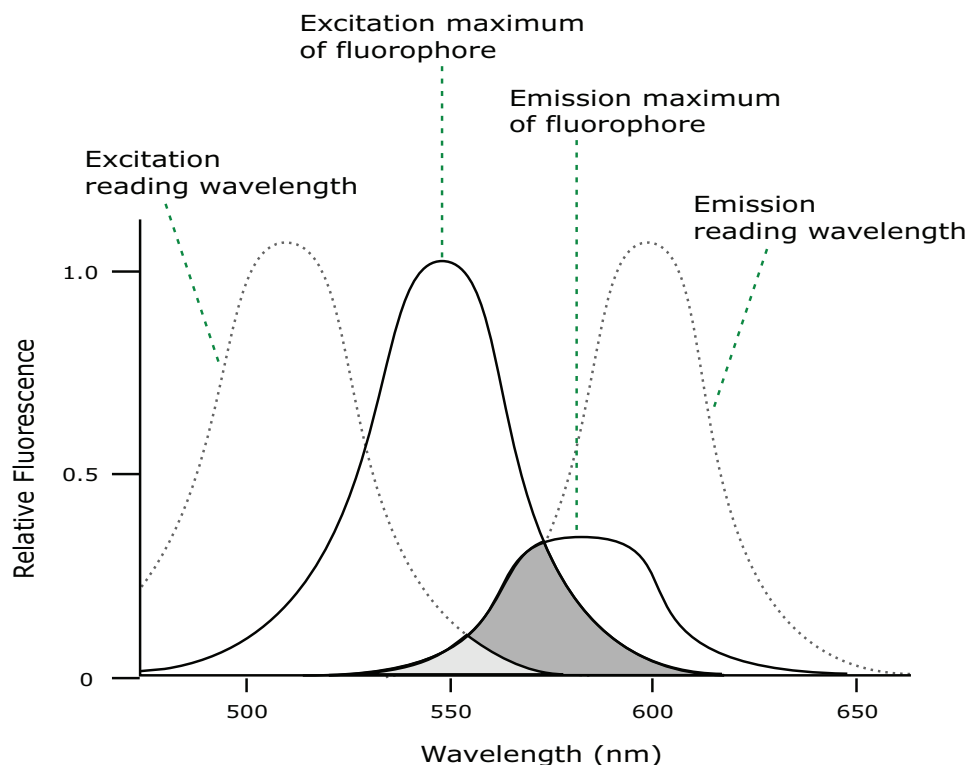

Optimized Excitation and Emission Read Wavelengths

The previous figure shows that the best results are often obtained when the excitation and emission wavelengths you use for the read are not the same as the peak wavelengths of the excitation and emission spectra of the fluorophore. When the read wavelengths for excitation and emission are separated, a smaller quantity of excitation light passes through to the emission monochromator (gray area) and on to the PMT, which results in a purer emission signal and more accurate data.

The instrument allows you to scan both excitation and emission wavelengths, using separate tunable dual monochromators. One benefit of scanning emission spectra is that you can determine more accurately whether the emission is, in fact, the expected fluorophore, or multiple fluorophores, and not one generated by a variety of background sources or by contaminants. One more benefit is that you can find excitation and emission wavelengths that prevent interference when interfering fluorescent species are present.

For this reason, it is desirable to scan emission for both an intermediate concentration of labeled sample, as well as the background of unlabeled sample. The optimal setting is where the ratio of the sample emission to background emission is at the maximum.

Fluorescence intensity data is dependent on several variables.

Applications of Fluorescence Intensity

Fluorescence intensity is used widely in applications such as fluorescent ELISAs, protein assays, nucleic acid quantitation, reporter gene assays, cell viability, cell proliferation, and cytotoxicity. One more major application is to study the kinetics of ion release.

Some assays use a fluorescent label to selectively attach to certain compounds. The quantity or concentration of the compound can then be quantified by measuring the fluorescence intensity of the label, which is attached to the compound. Such methods are often used to quantify low concentrations of DNA or RNA, for example.

Background Correction and Quantification

A blank well contains everything used with the sample wells except the label and sample-specific compounds. Do not use an empty well for a blank.

The blank sample reveals the offset underlying each data sample. This offset does not carry information on the label and is generally subtracted before data reduction is done.

Within the linear detection range, the blank-subtracted raw data are proportional to the quantity of label in a sample such that the label concentration is quantified by the following equation.

$$\text{conc}_{\text{label}} = \frac{(\text{sample-blank})}{\left(\frac{\text{std-blank}}{\text{conc}_{\text{std}}}\right)}$$

where conc_{std} is the concentration of the *standard*, and *sample*, *blank*, and *std* are average values of replicates for the sample, blank, and standard wells. In the general case where the standard curve covers a concentration range of more than a few linear logs, $(\text{std} - \text{blank}) / \text{conc}_{\text{std}}$ is equivalent to the slope of the standard curve, and so the concentration of the label is determined by $(\text{sample} - \text{blank}) / (\text{slope of standard curve})$.

For optimal results, you should run replicates for all blanks, controls, and samples. In this case, the blank value that will be subtracted is the average value of all blanks.

Detection Limit

The detection limit is the smallest sample concentration that can be detected reliably above the blank. Determining the detection limit requires taking a number of blank measurements and calculating an average value and standard deviation for the blanks. The detection threshold is defined as the average blank plus three standard deviations. If the average sample value measures above the threshold, the sample can be detected at a statistically significant level.

The detection limit can be described by the following equation:

$$\text{Det Limit} = \frac{3 \text{ StDev}_{\text{blank}}}{\left(\frac{\text{std-blank}}{\text{conc}_{\text{std}}}\right)}$$

where conc_{std} is the concentration of the standard, $\text{StDev}_{\text{Blank}}$ is the standard deviation of the blank replicates, and *blank* and *std* are average values of the replicates for the blank and standard wells.

Determining detection limits for assays requires multiple blanks to calculate their standard deviation.

Linearity and the Linear Dynamic Range

Within a wide range at moderately high concentrations, blanked raw data is proportional to the quantity of label in a sample.

The linear dynamic range (LDR) is defined by:

$$\text{LDR} = \log_{10} \left(\frac{\text{max conc lin}}{\text{detection limit}} \right)$$

where *LDR* is expressed as a log, and *max conc lin* is the highest concentration in the linear range that can be quantified.

When the standard curve after blank reduction is not linear in concentration at the lower end, there might be an incorrect or contaminated blank.

When the standard curve levels are off at the highest concentrations, this can be addressed to the inner filter effect: excitation does not reach as deep into the sample for lower concentrations, without being more significantly attenuated (absorbance) layer by layer.

Luminescence Read Mode

Luminescence is the emission of light by processes that derive energy from essentially non-thermal changes, the motion of subatomic particles, or the excitation of an atomic system by radiation. Luminescence detection relies on the production of light from a chemical reaction in a sample.

In luminescence (LUM) read mode, no excitation is necessary as the measured species emit light naturally. For this reason, the lamp does not flash, so no background excitation interference occurs.

For the luminescence read mode, the instrument provides measurements in Relative Light Units (RLUs).

To help eliminate background luminescence from a plate that has been exposed to light, you should dark adapt the plate by placing the sample-loaded plate inside the instrument for several minutes before you start the read.

The instrument bypasses the emission monochromator for luminescence reads that detect all wavelengths.

You can choose the wavelength where peak emission is expected to occur. Also, multiple wavelength choices let species with multiple components be differentiated and measured easily.

Concentrations or qualitative results are derived from raw data with a standard curve or by comparison with reference controls.

Applications of Luminescence

Chemiluminescent or bioluminescent reactions can be induced to measure the quantity of a particular compound in a sample. Examples of luminescent assays include the following:

- Reporter gene assays (the measurement of luciferase gene expression)
- Quantitation of adenosine triphosphate (ATP) as an indication of cell counts with cell-proliferation, cytotoxicity, and biomass assays
- Enzyme measurements with luminescent substrates, such as immunoassays

Luminescence Reads with Injectors

Injectors deliver a specified volume of a reagent to the wells of a plate. You generally use injectors when delivery of the reagent initiates a reaction that occurs rapidly and results in a luminescent or fluorescent signal that you must quickly detect.

Common inject-and-read assays include calcium flux assays.

Common inject-and-read assays include luciferase reporter assays.

The SpectraMax Injector cartridge is DLReady™ certified by Promega for the Dual-Luciferase Reporter (DLR™) assay system.

DLReady, DLR, and the DLReady logo are trademarks of Promega Corporation.



Analyzing Luminescence Data

The conversion rate of photons to counts is individual for each reader. Therefore, raw data from the same plate can seem significantly different from one instrument to the next. Also, the data format used by other manufacturers might not be counts per second and can be different by several orders of magnitude. It is important to know that the number of counts and the size of figures is not a benchmark of sensitivity.

Concentrations or qualitative results are derived from raw data with a standard curve or by comparison with reference controls. The raw data can then be expressed in equivalent concentration of a reference label. The raw data is normalized to counts per second by dividing the number of counts by the read time per well.

Background Correction

The light detected in a luminescent measurement generally has two components: specific light from the luminescent reaction and an approximately constant level of background light caused by various factors, including the plate material and impurities in the reagents. The background can be effectively measured using blank replicates. Blanks should include the luminescent substrate (chemical energy source) but not the luminescence agent (generally an enzymatic group which makes the substrate glow).

A blank well contains everything used with the sample wells except the label and sample-specific compounds. Do not use an empty well for a blank.

The blank sample reveals the offset underlying each data sample. This offset does not carry information on the label and is generally subtracted before data reduction is done.

For optimal results, you should run replicates for all blanks, controls, and samples. In this case, the blank value that will be subtracted is the average value of all blanks.

To help eliminate background luminescence from a plate that has been exposed to light, you should dark adapt the plate by placing the sample-loaded plate inside the instrument for several minutes before you start the read.

Sample Volumes and Concentration of Reactants

The concentration of the luminescent agent impacts the quantity of light output in a luminescent reaction. Light is emitted as a result of a reaction between two or more compounds. Therefore, the quantity of light output is proportional to the quantity of the limiting reagent in the sample.

For example, in an ATP/luciferin-luciferase system, when total volume is held constant and ATP is the limiting reagent, the blanked light output is proportional to the concentration of ATP in the sample. Even if the reaction begins with a high concentration of ATP, as it gets used up it can become rate-limiting. In this case, the non-linearity is an effect of the assay and not caused by the microplate reader.

Data Optimization

Measurement noise is dependent on the read time per sample (time per plate or time per well). The detection limit improves when you increase the read time. It is important to enter the read time when you compare measurements.

All low-light-level detection devices have some measurement noise in common. To average out the measurement noise, optimization of the time per well involves accumulating as many counts as possible. Within some range, you can reduce noise (CVs, detection limit) by increasing the read time per well, as far as is acceptable from throughput and sample stability considerations.

Z' is the standard statistical parameter in the high-throughput screening community to measure the quality of a screening assay independent of test compounds. Use this as a measure of the signal separation between the positive controls and the negative controls in an assay.

Use the following formula to determine the value of Z':

$$Z' = 1 - \frac{3(SD_{c+}) + 3(SD_{c-})}{| \text{Mean}_{c+} - \text{Mean}_{c-} |}$$

where **SD** is the standard deviation, **c+** is the positive control, and **c-** is the negative control.

A Z' value greater than or equal to 0.4 is the generally acceptable minimum for an assay. You can use higher values when results are more critical.

Z' is not linear and can be made unrealistically small by outliers that skew the standard deviations in either population. To improve the Z' value, increase the quantity of label in the sample, if acceptable for the assay, or increase the read time per well.



Perform only the maintenance tasks described in this guide. Contact a Molecular Devices service engineer to inspect and perform a preventive maintenance service on the instrument each year. See [Obtaining Support on page 100](#).

Before operating the instrument or performing maintenance operations, make sure you are familiar with the safety information in this guide. See [Safety Information on page 5](#).

The following topics describe maintenance and troubleshooting procedures that can be done by users to ensure optimal operation of the instrument.



CAUTION! Maintenance procedures other than those specified in this guide must be performed by Molecular Devices. When service is required, contact Molecular Devices technical support.

Preventive Maintenance

To ensure optimal operation of the instrument, do the following preventive maintenance procedures as required:

- Wipe off visible dust from exterior surfaces with a lint-free cloth to avoid dust build up on the instrument.
- Wipe up all spills immediately.
- Follow applicable decontamination procedures as instructed by your laboratory safety officer.
- Respond as required to all error messages the software displays.

You should power off the instrument when not in use.

Cleaning the Instrument



WARNING! BIOHAZARD. Always wear gloves when operating the instrument and during cleaning procedures that could involve contact with either hazardous or biohazardous materials or fluids.

Always turn the power off and disconnect the power cord from the main power source before you use liquids to clean the instrument.

- Wipe up all spills immediately.
 - Periodically clean the outside surfaces of the instrument using a cloth or sponge that has been lightly dampened with water.
 - If required, clean the surfaces using a mild soap solution diluted with water or a glass cleaner and then wipe with a damp cloth or sponge to remove all residue.
 - If needed, clean the plate drawer using a cloth or sponge that has been lightly dampened with water.
 - If a bleach solution has been used, wipe the instrument using a lint-free cloth that has been lightly dampened with water to remove the bleach residue.
-



CAUTION! Do not use abrasive cleaners. Do not spray cleaner directly onto the instrument or into any openings. Do not let water or other fluids drip inside the instrument.

Clean Touchscreen

The touchscreen is made of coated glass. The coating that covers the glass is soft and can be scratched. Do not touch, push or rub the touchscreen with anything harder than an HB pencil lead. Do not put or attach anything on the display area to avoid leaving marks.

If the display surface becomes contaminated, breathe on the surface and gently wipe it with a soft dry cloth. If it is heavily contaminated, moisten cloth with one of the following solvents:

- Isopropyl alcohol
- Ethyl alcohol



CAUTION! Do not scrub hard and do not use solvents other than those mentioned above. Do not use: water, ketone, or aromatic solvents.

Cleaning Injectors and Accessories



CAUTION! Do not clean the inside of the injector other than the inside of the bottle holder. Cleaning the inside can cause damage.

Periodically clean the outside surfaces, the inside and outside of the bottle holder, the snorkel clamps, and the snorkel end of the injector tubing with a lint-free cloth that has been lightly dampened with water. You can remove the bottle holder for cleaning. See [Assembling and Maintaining Injectors on page 25](#).

If decontamination is required, use a lint-free cloth that has been lightly dampened with a decontaminating solution, such as 70% ethanol or 3% sodium hypochlorite. See [Compatible Solutions on page 110](#).



Note: After you use a decontamination solution, always wipe the areas with a lint-free cloth that has been lightly dampened with water to remove the residue. If you use sodium hypochlorite, wipe the areas with a lint-free cloth that has been lightly dampened with 70% alcohol before you wipe again with water.



CAUTION! Do not use abrasive cleaners. Do not spray cleaner directly onto the instrument. Do not immerse the injector.

To clean the waste plate, strip wells, bottles, and adapters, use a lightly dampened, lint-free cloth. After you clean these accessories, let them air dry on absorbent paper or cloth. Invert the waste plate, strip wells, and bottles so that they drain as they dry. These accessories can be replaced if cleaning is no longer practical. See [Injector Specifications on page 106](#).

To clean the injector tips, remove the bottles from the bottle holder. Dab the surface of the injectors with a lightly dampened, lint-free cloth. Do not insert anything into the injector tips as this can damage their internal non-stick coating.

To clean the inside of the injector tubing, use the Wash operation. See [Washing Injector Tubing on page 42](#).

Troubleshooting



CAUTION! Maintenance procedures other than those specified in this guide must be performed by Molecular Devices. When service is required, contact Molecular Devices technical support.



WARNING! BIOHAZARD. It is your responsibility to decontaminate components of the instrument before you request service by a service engineer or you return parts to Molecular Devices for repair. Molecular Devices does not accept items that have not been decontaminated where applicable to do so. If parts are returned, they must be enclosed in a sealed plastic bag that states that the contents are safe to handle and are not contaminated.

Observe the cleaning procedures outlined in this guide for the instrument.

Do the following before you clean equipment that has been exposed to hazardous material:

- Contact the applicable Chemical and Biological Safety personnel.
- Review the Chemical and Biological Safety information contained in this guide. See [Chemical and Biological Safety on page 9](#).

Do only the maintenance described in this guide. Maintenance procedures other than those specified in this guide must be done by qualified Molecular Devices personnel only. See [Obtaining Support on page 100](#).

To clean the instrument, use disinfectant wipes according to the supplier instructions. Disinfect the entire instrument outer surface with an emphasis on the following areas you will handle when packing, unpacking and servicing the instrument:

- Plate Carrier
- Instrument Top
- Touchscreen
- Cover Edges
- Underneath Between Instrument Feet
- Rear Edges (do not damage the warranty seal)

Replacing Fuses

If the instrument does not seem to get power after you switch it on, check to see whether the power cord is securely plugged into a functioning power outlet and to the power port on the rear of the instrument.

If the power failed while the instrument was on, verify that the power cord is not loose or disconnected and that power to the power outlet is functioning properly.

If these checks fail to remedy the loss of power, replace the fuses. You can obtain replacement fuses from Molecular Devices. For fuse specifications and part numbers, see [Physical Specifications on page 104](#)



CAUTION! Do not touch or loosen screws or parts other than those specifically designated in the instructions. Doing so could cause misalignment and possibly void the warranty.

The fuses are located in the fuse carrier which is part of the power outlet on the rear of the instrument.

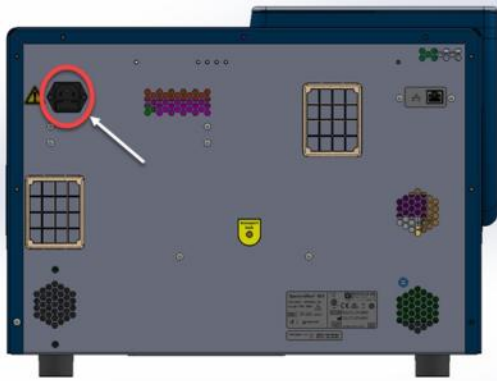

To replace the fuses:



WARNING! HIGH VOLTAGE Always turn off the power and disconnect the power cord from the main power source before you do a maintenance procedure that requires removal of a panel or cover or disassembly of an interior instrument component.

1. Press and hold the power button to power off the instrument.
2. Unplug the power cord from the power port.
3. Use a small slot-head screwdriver to gently press on the carrier-release tab and then pull the fuse carrier to remove it from the instrument.
4. Gently pull the old fuses from the carrier by hand.
5. Gently place new fuses into the carrier by hand.
6. Press the fuse carrier into the instrument until the carrier snaps into place.
7. Plug the power cord into the power port.
8. Turn on power to the instrument.



Note: If the instrument still does not power on after you change the fuses, contact Molecular Devices technical support. See [Obtaining Support on page 100](#).

Before You Move the Instrument

When you move the instrument from one location to a new location, there are several things you must do before you power off the instrument.

This procedure requires the following tool included in the accessories tool box:



WARNING! LIFTING HAZARD. To prevent injury, use a minimum of two people to lift the instrument.

Illustration	Part Number	Description
	YW 000 012	Horex HEXAGON ballhead bolt driver 3 mm



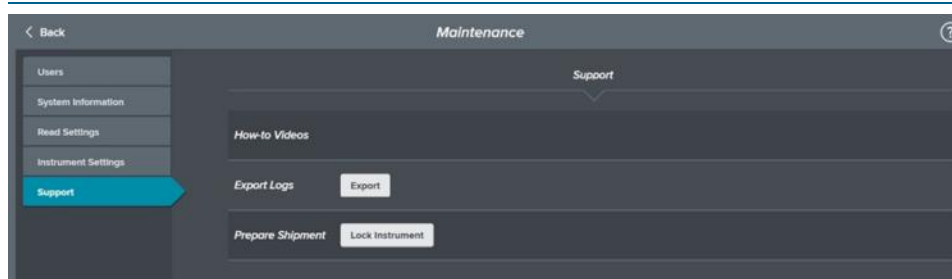

CAUTION! When transporting the instrument, warranty claims are void if improper packing results in damage to the instrument.



If you directly connect a computer to the instrument, make sure that the SoftMax Pro Software is not running and turn off the computer.

Before you power off the instrument, do the following to prepare the instrument for a move.

1. Tap  and remove the plate from the plate drawer, if present.
2. Tap  to display the Maintenance page.
3. Tap **Support** to display the Support tab.
4. Tap **Lock Instrument** to move the transport slide into a position that can accept the transport lock.
5. You are prompted to confirm that there is no plate in the drawer. When there is no plate in the drawer, tap **OK**.

6. On the rear of the instrument, remove the black cover from the travel lock opening in the center.

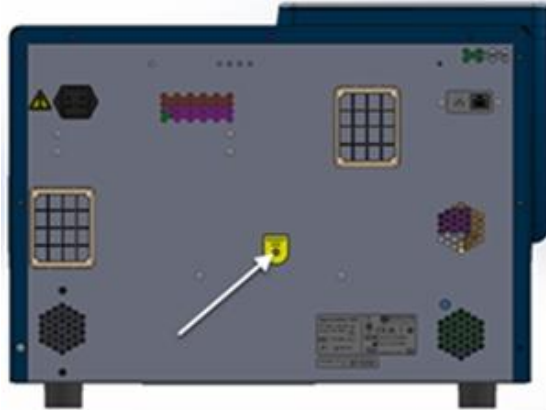

7. Insert the 3.0 mm Hoxlex HEXAGON ballhead bolt driver into the Transport Lock opening and tighten the interior screw into the transport slide.

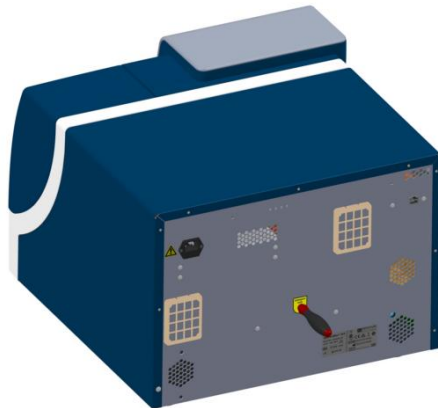

Note: The screw remains inside the instrument. The screw is spring mounted and cannot get lost within the instrument. Tighten the screw until it is snug. This locks the transport slide.

8. Replace the black cover in travel lock opening.
9. Move to the front of the instrument and tap **OK** to confirm that the transport slide has been locked. The plate drawer opens to allow you to install the transport lock on the plate drawer and the instrument proceeds to shut down.
10. Unplug the power cord and Ethernet cable from the rear of the instrument and from the wall outlet. Store the power cord and Ethernet cable in the accessories tool box.
11. Install the transport lock on the plate drawer. See [Installing Transport Locks on page 97](#).
12. If you plan to store the instrument, ship the instrument, or transport the instrument to a different building, pack the instrument in the original packaging. See [Packing the Instrument on page 98](#).
13. Make sure that the new location is a dry, flat work area that has sufficient space for the instrument and required cables. See [Instrument Specifications on page 101](#).

Installing Transport Locks

Before you move or pack the instrument, do all the steps in [Before You Move the Instrument on page 95](#) to move the transport slide and the plate drawer into the position to accept the transport locks and to remove the cables from the instrument. The transport locks protect the instrument from damage during a move or shipment.

CAUTION! Do not touch or loosen screws or parts other than those specifically designated in the instructions. Changes to other screws or parts can cause misalignment and possibly void the warranty.

When you do all the steps in [Before You Move the Instrument on page 95](#) section, the transport slide moves to the correct position, you lock the transport slide, the plate drawer door opens, and the plate drawer moves into the position to accept the transport lock.

If you did not insert the 3.0 mm Horex HEXAGON ballhead bolt driver into the Transport Lock opening and tighten the interior screw into the transport slide you must power on the instrument and perform the steps in the [Before You Move the Instrument on page 95](#) topic.

To install the transport lock on the plate drawer:

1. Place the plate drawer transport lock on the end of the plate drawer.
2. Use the 2.0 mm hex key to tighten screws #2 and #3 until the lock is attached to the plate drawer.

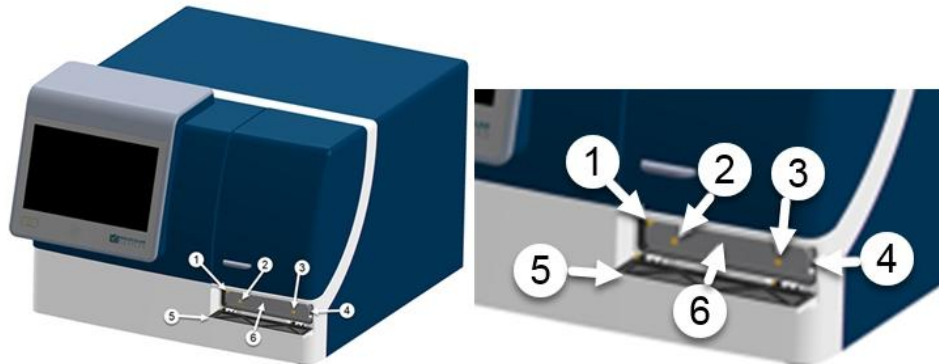

Plate Drawer Transport Lock

Item	Description
1	Screw #1 fastens the lock to the internal frame of the instrument
2	Screw #2 fastens the lock to the plate drawer
3	Screw #3 fastens the lock to the plate drawer
4	Plate drawer
5	Plate door in open position
6	Plate drawer transport lock

3. Gently push the plate drawer into the instrument and as far to the left as possible until screw #1, which fastens the lock to the internal frame of the instrument, lines up with the hole on the internal frame. The plate door must be held open manually until you fasten the transport lock.
4. Tighten screw #1 until the plate drawer is securely locked in place.

5. Route the yellow tab connected to the transport lock so that it will pass over the top of the plate door when the door is closed.
6. Gently close the plate door.

Packing the Instrument

To minimize the possibility of damage during storage or shipment, the instrument should be repacked in the original packaging materials.



CAUTION! When transporting the instrument, warranty claims are void if improper packing results in damage to the instrument.

Do all steps in [Before You Move the Instrument on page 95](#) and [Installing Transport Locks on page 97](#) before you proceed with the following procedures. Correct packaging of the instrument also includes applicable decontamination procedures.



CAUTION! Keep the box upright. Do not tip or tilt the box or place it on its side.

The instrument should be stored in a dry, dust-free, environmentally controlled area. For more information about acceptable storage environments, see [Instrument Specifications on page 101](#).



WARNING! LIFTING HAZARD. To prevent injury, use a minimum of two people to lift the instrument.

To pack the instrument in the original packaging:

1. Make sure you have done all the steps in [Before You Move the Instrument on page 95](#) and [Installing Transport Locks on page 97](#).
2. Store the power cord and Ethernet cable in the instrument accessories toolbox.
3. Wrap the instrument in static-free plastic.
4. Replace the molded foam packaging around the instrument.

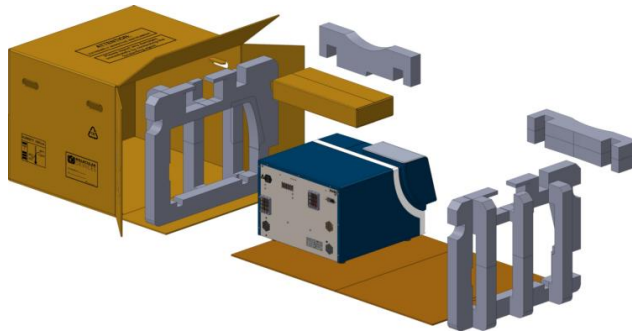

CAUTION! Keep the instrument upright and level when lifting. Do not tip or shake the instrument to prevent damage to the moving components inside the instrument.

5. Place the accessories tool box in the foam packaging above the instrument.

6. Place the instrument and accessories tool box on the flat cardboard piece and slide it into the original box.

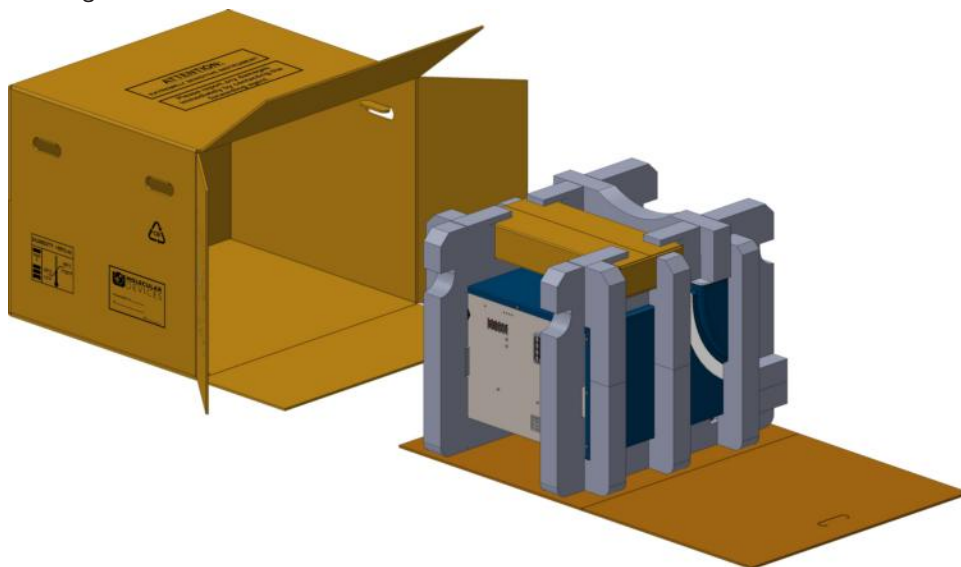

7. Fold up the cardboard flap inside the box.



8. Along the side labeled **Open Here**, close the box and seal it with packing tape.

Obtaining Support

Use the Support tab on the Maintenance page to view how-to videos, to export log files to a location from where you can send the log file to a support engineer, and to move the transport slide into a position where it can accept the physical transport lock in preparation for instrument shipment or storage. See [Installing Transport Locks on page 97](#).



From the icons on the left, tap  to display the Maintenance page and then tap **Support** to display the Support tab.

- Tap a how-to video for instrument instructions.
- Tap **Export** to export a log file to assist with technical support.
- Tap **Lock Instrument** to lock the instrument for shipment. This moves the transport slide into a position where it can accept the transport lock and then powers off the instrument. See [Before You Move the Instrument on page 95](#).

Molecular Devices is a leading worldwide manufacturer and distributor of analytical instrumentation, software, and reagents. We are committed to the quality of our products and to fully supporting our customers with the highest level of technical service.

Our Support website, support.moleculardevices.com, has a link to the Knowledge Base, which contains technical notes, software upgrades, safety data sheets, and other resources. If you still need assistance after consulting the Knowledge Base, you can submit a request to Molecular Devices Technical Support.

You can contact your local representative or Molecular Devices Technical Support at 800-635-5577 x 1815 (North America only) or +1 408-747-1700. In Europe call +44 (0) 118 944 8000.

To find regional support contact information, visit www.moleculardevices.com/contact.

Please have your instrument serial number or Work Order number, and your software version number available when you call. You can find this information on the Maintenance page - Instrument tab. See [Maintenance Page on page 52](#).

Appendix A: Instrument Specifications



This appendix provides specifications for the iD3 basic instrument.

Measurement Specifications

The following tables list the instrument measurement specifications.

Table A-1: Read Times Using Quick Read (plate in/out may add 10-15 seconds)

Read Mode	96-Wells	384-Wells
Absorbance	0.5 min	1.5 min
Fluorescence Intensity	0.5 min	1.5 min
Luminescence	0.5 min	1.5 min

Table A-2: Absorbance Measurement Specifications

Item	Description
Wavelength range	230 - 1000 nm
Wavelength selection	Monochromator tunable in 1 nm increments
Wavelength bandwidth	4.0 nm full width half maximum
Wavelength accuracy	± 2.0 nm across wavelength range
Wavelength repeatability	± 1.0 nm
Photometric range	0 - 4.0 OD
Photometric resolution	0.001 OD
Photometric accuracy	$< \pm 0.010$ OD $\pm 1.0\%$, 0 - 3 OD VIS 0 - 3 OD UV
Photometric precision (repeatability)	$< \pm 0.003$ OD $\pm 1.0\%$, 0 - 3 OD VIS 0 - 3 OD UV
Stray light	$\leq 0.05\%$ at 260 nm, 280 nm
Photometric stabilization	Instantaneous
Photometric drift	None (continuous referencing of monochromatic input)
Calibration	Automatic before every endpoint read and before the first kinetic read
Optical alignment	None required
Photodetectors	Silicon Photodiode

Table A-3: Fluorescence Intensity Measurement Specifications

Item	Description
Wavelength range	EX 250 - 830 nm EM 270 - 850 nm
Wavelength selection	Monochromators tunable in 1.0 nm increments
Wavelength accuracy	±2 nm
Wavelength precision	±1 nm
Bandwidth (EX/EM)	EX: 15 nm EM: 25 nm
Number of excitation/emission pairs per plate	4
Dynamic range	>6 logs
Sensitivity top read mono*	Fluorescein
96-wells	4 pM - Guaranteed 1 pM - Optimized
384-wells	6 pM - Guaranteed 1 pM - Optimized
Sensitivity bottom read mono*	Fluorescein using glass bottom Greiner Sensoplate™ glass bottom multiwell plates
96-wells	10 pM - Guaranteed 2 pM - Optimized
384-wells	10 pM - Guaranteed 2.5 pM - Optimized
System validation	Self-calibrating with built-in fluorescence calibrators
Light source	High power xenon flash lamp
Average lamp lifetime	1 billion flashes or 2 years normal operation

Table A-4: Luminescence Measurement Specifications

Item	Description
Wavelength selection	Choice of simultaneous detection of All Wavelengths or selection in 1.0 nm increments
Wavelength range	300 - 850 nm 300 - 650 nm for "All Wavelengths" setting
Wavelength accuracy	±2 nm
Wavelength precision	±1 nm
Dynamic range	>7 decades
Sensitivity top read*	Perkin Elmer ATPlite 1step Luminescence Assay System
96-well	10 pM - Guaranteed 2 pM - Optimized
384-well	20 pM - Guaranteed 4 pM - Optimized
Crosstalk	<0.1% in white 96-well half area plate <0.2% in white 384-well Costar small volume

*For properly functioning, operating, and maintained equipment.

Physical Specifications

The following tables list the physical specifications of the instrument.

Table A-5: Physical Specifications

Item	Description
Environment	Indoor use only
Power requirements	100-240 VAC \pm 10%, 2 A, 50/60 Hz
Dimensions	53.2cm W x 40.1cm H x 59.8cm D (20.94 in. W x 15.79 in. H x 23.54 in. D)
Front clearance	11 cm (4.33 in.) for plate drawer
Rear clearance	20 cm to 30 cm (7.9 in. to 11.8 in.) between the rear of the instrument and the wall for ventilation and cable disconnects
Size	Width: 53.2 cm (20.94 in.) height: 40.1 cm (15.79 in.) depth: 59.8 cm (23.54 in.) height of plate drawer: 9.5 cm (3.7 in.)
Weight	40 kg (88.1 lbs)
Plate formats	6, 12, 24, 48, 96, 384-well plates ANSI/SLAS conformant Maximum height: 22 mm
Reading capability	Plates and cuvettes (with adapter) SpectraCuvette Adapters without a sticker have a plate height of 24 mm and cannot be used in the SpectraMax iD3 or SpectraMax iD5.
Robotic compatible	Yes
Shake	Orbital, double orbital, and linear
Temperature control	5°C (7.2° F) above ambient up to 66°C (150.8° F) At temperature range from 55°C (131°F) up to 66°C (150.8°F) ambient temperature of 25°C (77°F) is required.
Chamber temperature	<5°C ambient 25°C, under DutyCycle of: FL Top, 400ms/well, complete 384-wells, pause to achieve 10 min cycle time, eject, wait 30 sec, load.
Temperature uniformity	\pm 0.75°C (1.35°F)
Temperature accuracy	\pm 1°C (1.8°F) at 37°C (98.6°F) Set Point
Wavelength selection	1.0 nm Increments
Ambient operating temperature	15°C to 40°C (59°F to 104°F)

Table A-5: Physical Specifications (continued)

Item	Description
Ambient storage temperature	-5°C to 40°C (23°F to 104°F) continuous; -20°C to 50°C (-4°F to 122°F) transient (up to 10 hours)
Humidity restrictions	15% to 75% (non-condensing) at 30°C (86°F)
Altitude restrictions	Up to 2000 m (6562 ft)
Air pressure restrictions	54 kPa to 106 kPa (7.8 PSI to 15.4 PSI)
Sound pressure level	Maximum sound pressure: 73 dBA Maximum sound pressure at one meter: 68 dBA
Installation category	II
Pollution degree	2
Data connection	One Ethernet port
NFC antenna reader/writer	SANGOMA-MSMA 2V5 13.56 Mhz Multi Standard - Multi Antenna Reader/Writer Contains FCC ID: 2AKHW-SANGMSMA4 Contains IC: 22202-SANGMSMA4 Changes or modifications made to this equipment not expressly approved by the party responsible for compliance may void the FCC authorization to operate this equipment.

Regulatory for Canada (ICES/NMB-001:2006)

This ISM device complies with Canadian ICES-001.

Cet appareil ISM est conforme à la norme NMB-001 du Canada.

ISM Equipment Classification (Group 1, Class A)

This equipment is designated as scientific equipment for laboratory use that intentionally generate and/or use conductively coupled radio-frequency energy for internal functioning, and are suitable for use in all establishments, other than domestic and those directly connected to a low voltage power supply network which supply buildings used for domestic purposes.

Injector Specifications

When your instrument has the SpectraMax Injector System, the specifications for measurements using the injector are shown in the following table.

Table A-6: Measurement Specifications For the Injector

Item	Description
Name	Injector
Weight	1.7 kg (3.7 lbs)
Plate formats	6, 12, 24, 48, 96, and 384-well plates
Read modes	The injector system is method independent. You can use injectors for Absorbance, Luminescence (all wavelength), Luminescence Monochromator, Fluorescence Intensity top, and Fluorescence Intensity bottom read modes.
Type	Single emission
Light source	None
Labels/Substrates	Labels compatible with the wavelength range
Detection limit, optimized	20 amol ATP ("Flash" luminescence using Promega ENLITEN [®] ATP Assay System)
Detection limit, guaranteed	50 amol ATP (<=> 250 fM @ 0.2mL/well, "Flash" luminescence using Promega ENLITEN ATP Assay System)
Linear dynamic range	5 logs in a single plate read
Injectors	2
Dispense volume	1 μ L increments from 1 μ L to the maximum allowable volume of the well, based on the selected plate type
Dispense accuracy	$\pm(4\%$ of volume + 1 μ L) / volume x 100%
Dispense precision	$\leq 2\%$ of volume + 1 μ L) / volume [μ L] x 100% cv
Dispense speed	100 μ L per second
Dead volume	50 mL bottle: 1 mL Injector tubing: 250 μ L Fill the bottles with enough reagent for your experiment plus at least 2 mL to account for the prime operation and the quick-prime operation before the plate is read, and for the dead volume in the bottle and the tubing.
Minimum delay between injection and ABS	Injector 1 800 msec after injection ends Injector 2 800 msec after injection ends
Minimum delay between injection and LUM (top) read	Injector 1: 500 msec after injection ends Injector 2: 500 msec after injection ends
Minimum delay between injection and FL (bottom) read or FL (top)	Injector 1: 500 msec after injection ends Injector 2: 500 msec after injection ends

Table A-7: Plate Selection Guidelines For the Injector

Read Mode	Plate Type	Other Considerations
Luminescence (LUM), top read	Solid white If luminescence crosstalk is high, then use a black plate to improve sensitivity.	When an application specifies a surface treatment, use only plates with the correct treatment. For reads with injection, plates must be unlidded.
Fluorescence Intensity (FL), bottom read	Black-sided, clear bottomed	When an application specifies a surface treatment, use only plates with the correct treatment.



Note: White plates provide significantly higher signal for luminescence than black plates, and are recommended if high sensitivity is required. However, white plates can exhibit some detectable phosphorescence that increases background after being exposed to light (in particular under neon lights). For maximum sensitivity, you should prepare plates under reduced ambient light conditions, and place the plate inside the instrument for 1 to 10 minutes to adapt the plates to darkness before you start the read.



Appendix B: Accessories



Validation Packages Part Numbers

Part Number	Item Name	Compatible Instruments
0200-6191	SpectraTest ABS2 Absorbance Validation Plate	FlexStation 3, SpectraMax ABS, SpectraMax ABS Plus, SpectraMax i3, SpectraMax i3x, SpectraMax iD3, SpectraMax iD5, SpectraMax M2, SpectraMax M2e, SpectraMax M3, SpectraMax M4, SpectraMax M5, SpectraMax M5e, SpectraMax Plus 384
0200-5060	SpectraTest FL1 Fluorescence Validation Plate	FlexStation 3, Gemini EM, Gemini XPS, SpectraMax i3, SpectraMax i3x, SpectraMax iD3, SpectraMax iD5, SpectraMax M2, SpectraMax M2e, SpectraMax M3, SpectraMax M4, SpectraMax M5, SpectraMax M5e
0200-6186	SpectraTest LM1 Luminescence Validation Plate	FlexStation 3, SpectraMax i3, SpectraMax i3x, SpectraMax iD3, SpectraMax iD5, SpectraMax L, SpectraMax M3, SpectraMax M4, SpectraMax M5, SpectraMax M5e
0200-2420	Cuvette Absorbance Validation Set	SpectraMax ABS Plus, SpectraMax M2, SpectraMax M2e, SpectraMax M3, SpectraMax M4, SpectraMax M5, SpectraMax M5e, SpectraMax Plus 384
0200-7200	Multi-Mode Validation Plate	FilterMax F3, FilterMax F5, SpectraMax i3*, SpectraMax i3x*, SpectraMax iD5*, SpectraMax Paradigm * Specific read modes or cartridges.

Injector Accessories

The injector and the following accessories are available to order from Molecular Devices.

Injector and Injector Accessories

Part Number	Description
ID5-INJ-UPG	Injector upgrade kit (Installed by Molecular Devices)
5055251	Bottle holder
5044163	Waste plate
5044164	Tubing
5044165	Bottle adapter
Cannot order from Molecular Devices	Wide-neck bottle, HDPE 50 mL capacity 36 mm square by 68 mm high 24 mm diameter inside neck Recommended supplier: VWR (215-0440)
Cannot order from Molecular Devices	Strip wells, polystyrene1x8, clear, flat-bottomed. Recommended supplier: Greiner Bio-One (762001)

Compatible Solutions

Use only compatible solutions with the injector.

The following table gives a partial list of commonly used compatible and incompatible solutions for dispensing through the injector tubing or for exterior cleaning of the injector and accessories. Most reagents are compatible with the injector, as long as the components used in the solution are in the compatible list. For a complete substance compatibility list, visit the knowledge base on the Molecular Devices technical support site.

Before you use a substance that is not listed, contact Molecular Devices technical support. See [Obtaining Support on page 100](#).



CAUTION! The information in this table is based on substance-compatibility information provided by suppliers of the materials used in the injector and other reputable sources. Before you run an assay, always test the behavior of substances under the specific conditions of your application.

List of Compatible and Incompatible Solutions

Compatible Solutions	Do Not Use
Alcohol, Ethyl (Ethanol), 70% solution or less	Acetone
Alcohol, Isobutyl (Isobutanol), 70% solution or less	Alcohol, Benzyl (Phenylcarbinol)
Alcohol, Methyl (Methanol), 70% solution or less	Hydrochloric Acid (HCl)
Ammonia, 10% solution or less	Ketones
Sodium Hypochlorite (NaClO), 3% solution or less	Sulfuric Acid (H ₂ SO ₄)
Water (deionized, distilled, or fresh)	Water (salt or saline)



CAUTION! Always read the label or Safety Data Sheet (SDS) to determine the actual percentage of the substance in a solution. For example, household bleach generally contains approximately 5% sodium hypochlorite, so a 50% reduction yields less than a 3% solution of NaClO.

Contact Us

Phone: [+1-800-635-5577](tel:+18006355577)
Web: moleculardevices.com
Email: info@moldev.com

Visit our website for a current listing of worldwide distributors.