

3D HISTECH

Pannoramic SCAN II
2.0
User's Guide

June 4, 2018
Rev. 2

PSII123-UG-EN-Rev2

For research and education uses only, not for use in diagnostic procedures.

Contents

Disclaimer.....	5
Character Formats and Symbols.....	7
Declaration of Conformity.....	8
Notes Regarding Operational Safety.....	9
Notes on Warranty.....	11
Terms and Abbreviations.....	12
1 Product Description.....	13
1.1 Product Overview.....	13
1.1.1 Intended Use.....	13
1.1.2 Features and Benefits.....	13
1.1.3 Warning and Information Labels.....	15
1.1.4 Base Unit.....	16
1.2 System Overview.....	17
1.2.1 Pannoramic SCAN II system.....	17
1.2.2 Hardware Options.....	18
1.2.3 Control Software.....	20
2 Installation.....	22
2.1 Control computer ports.....	22
2.2 Connectors and cables.....	23
2.3 Coupling the Lumencor SOLA SM II unit with the scanner.....	24
2.4 Coupling the Lumencor Spectra 6 unit with the scanner.....	24
3 Operating Slides and Magazines.....	26
3.1 Preparing Slides and Magazines.....	26
3.2 Affixing Barcode Stickers to Slides.....	27
3.3 Inserting and Removing Slides.....	28
4 Software Description.....	32
4.1 Starting / Exiting Pannoramic Scanner Software.....	32
4.1.1 Starting the software.....	32
4.2 Main window functions.....	33
5 Scanning modes and settings.....	46
5.1 Brightfield Scanning Mode.....	46

5.1.1 Profile Settings Panel.....	47
5.1.2 Microscope Control Panel.....	54
5.1.3 Quick microscope functions.....	65
5.2 Fluorescence Microscope Mode.....	68
5.2.1 Profile Settings panel.....	68
5.2.2 Microscope Control Panel.....	77
5.2.3 Hidden functions.....	88
5.2.4 Quick Microscope functions.....	89
5.2.5 Bottom menu bar of the main window.....	92
5.3 Planner mode.....	94
5.3.1 General functions at the main menu.....	95
5.3.2 General functions at the magazine menu.....	97
5.3.3 General functions at the slide menu.....	97
5.3.4 Slide view with card.....	98
5.3.5 Table view mode.....	101
5.3.6 Card collection view mode.....	102
5.4 Profile and Preview overview on the Planner.....	103
5.5 Progress features.....	104
5.6 Services and Settings.....	104
5.6.1 Services.....	104
5.6.2 Settings.....	111
5.7 Hosting.....	115
5.8 Using Profiles.....	117
6 Troubleshooting and Maintenance.....	119
6.1 Safety Information.....	119
6.1.1 Cleaning the device.....	120
6.1.2 Cleaning the magazine.....	120
6.1.3 Preventive maintenance.....	120
6.2 Troubleshooting.....	121
6.2.1 Fluorescent Applications (optional).....	123
6.3 Maintenance.....	124
6.3.1 Removing the protective covers.....	124
6.3.2 Removing a slide.....	125
6.3.3 Installing and Removing the Filter Module (Fluorescent Option).....	127
6.3.4 Removing the magazine from the transporting system.....	129
6.3.5 Transporting Pannoramic SCAN II.....	130
7 Technical Data.....	132
Appendix – Packaging instructions.....	136
Preparations.....	136
Main parts and their accessories.....	136
Packaging.....	138

Packing the SCAN II scanner.....	140
Packing the accessories.....	140
Closing the package.....	140
Handling of the package.....	141
Index.....	142

Disclaimer

Copyright © 2001-2018 3DHISTECH Ltd.
All rights reserved.

Intellectual property related to the 3DHISTECH products are as follows:

EP 1,789,831; US 7,663,078; EP 2,024,772; JP 2009-512685; US 12/301,781; EP 1,644,767; JP 2007-516451; US 7,327,515; EP 1,994,398; JP 2008-557835; US 12/281,566; U0700210; US 6,246,785; HU0900142; HU0700404; PCT/HU2007/000065; EP 08762668.5; US 12/663,537; PCT/AT2006/000492; JP 2008-542552; EP 06817469; US 12/095,545; PCT/AT2006/000493; EP 06817470.5; US 12/095,596; HU0900741; US 61/264,732; US 11/826,752; P0401870; PCT/IB2005/050344; US 11/662,976; HU0700409; US 12/042,050; US 77/636,144 and 007502032.

The above mentioned granted patents, granted utility model, registered trademarks, pending international and national patent applications and the other corresponding IP are the sole properties of the 3DHISTECH Ltd.

CAUTION

For research and education uses only, not for use in diagnostic procedures. This product has not been approved or cleared as a medical device by the U.S. Food and Drug Administration or the European Union.

Do not use this device in close proximity to sources of strong electromagnetic radiation (e.g. unshielded intentional RF sources), as these may interfere with the proper operation.

Further Information

For the latest information on 3DHISTECH products and services, please visit our website at the following URL: <http://www.3dhitech.com>.

Or contact the distributor:

Richard Allan Scientific Co.
Subsidiary of Thermo Fisher Scientific
4481 Campus Drive
Kalamazoo Mi 49008, USA
US Toll Free 1(800) 522-7270

Tudor Road, Manor Park
Runcorn, WA7 1TA
United Kingdom
+44 (0) 800 018 9396
+44 (0) 1928 534 000

Character Formats and Symbols

Example	Words or characters that appear on the screen. These include field names, screen and window titles, pushbutton and menu names, paths or options. Keys on the keyboard. For example, function keys (such as F11) or the Ctrl+M key combination.
Example	Cross-references within the document or to other documents.
Warning!	It might cause irreversible damage or harm to the user of the product or the product itself if this instruction is not followed.
Caution!	It might cause the product to not work properly if this instruction is not followed and alerts to a potential danger situation.
Note:	Calls attention to some important features.

Declaration of Conformity

3DHISTECH Ltd. declares that the product Pannoramic SCAN II slide scanner is designed and produced with consideration of specified requirements according to the standards listed below:

IEC 61010-1:2010, "Safety Requirements for Electrical Equipment for Measurement, Control, and Laboratory Use - Part 1: General Requirements"

IEC 61010-2-101:2015, " Safety Requirements for Electrical Equipment for Measurement, Control, and Laboratory Use

IEC 61010-2-081:2015, "Safety requirements for electrical equipment for measurement, control and laboratory use - Part 2-081: Particular requirements for automatic and semi-automatic laboratory equipment for analysis and other purposes"

IEC 62471:2006, "Photobiological safety of lamps and lamp systems"

IEC 61326-2-6:2012, "Electrical equipment for measurement, control and laboratory use - EMC requirements - Part 2-6: Particular requirements - In vitro diagnostic (IVD) medical equipment"

There is no further operator (user) action required in case of residual risks.

Further information may be obtained from the distributor:



Richard Allan Scientific Co.
Subsidiary of Thermo Fisher Scientific
4481 Campus Drive
Kalamazoo MI 49008, USA
US Toll Free 1(800) 522-7270

Tudor Road, Manor Park
Runcorn, WA7 1TA
United Kingdom
+44 (0) 800 018 9396
+44 (0) 1928 534 000

Notes Regarding Operational Safety







The below section of this User's Guide contains information and warnings of a kind that must be followed by owner/operator personnel.











Warning and advisory symbols which are used on the base unit of the Pannoramic SCAN II and in section **1.1.3 Warning and Information Labels** have the following meanings:

	CAUTION Disconnect mains plug before any kind of intervention into the device!
	CAUTION Crush hazard!

The Pannoramic SCAN II, including any of its original accessory components, should not be operated in any other way than described in section **1.1.1 Intended Use**.

Any of the following notes should be strictly observed:

 Warning!	If operating the device other than specified by the manufacturer, the level of safety will decrease.
 Caution!	In the event of any non-conforming type of use, including non-conforming use of assemblies or single parts, no liability will be assumed by the Manufacturer. This shall also apply to service or repair work of any kind, which is performed by other than duly authorized service personnel. All claims for warranty and warranty services will be null and void in any such case.
 Note:	The safety level of the equipment after servicing will be identical with level of the original equipment.
 Warning!	Insert the power cord plugs only into a grounding outlet. The protective action must not be rendered ineffective by extension cables without protective conductor. The Pannoramic SCAN II has a built-in protection which must not be rendered ineffective by extension cables without protective (earth-ground) conductor.
 Warning!	Never operate the device in explosion-risk environment.
 Warning!	If protective devices are found to be ineffective, the Pannoramic SCAN II must be shut down and precautions must be taken to prevent unintended usage. For necessary repair work or work to restore proper operating condition, you should contact the Thermo Fisher Scientific Customer Service.
 Note:	Electric power to the Pannoramic SCAN II is supplied via an external mains power supply unit. It allows for operation at line voltages in the range of 100 V to 240 V $\pm 10\%$, 50/60 Hz, without any extra facilities required for voltage transformation.

 Warning!	Check that your local line voltage is compatible with Pannoramic SCAN II specifications before you turn power on.
 Disconnect plug!	Remember to unplug the power cord before you open the Pannoramic SCAN II main unit for maintenance.
 Warning!	Only connect external devices to the instrument which are approved to avoid the risk of electrical shock.
 Warning!	Pannoramic SCAN II does not include any special facilities to protect from samples with an etching, potentially infectious, toxic, radioactive or other health-damaging effect. You are under obligation to comply with all currently binding legislation, notably, national accident prevention rules when handling samples of this kind.
 Caution!	Dirt or dust may adversely impact the operating capability of the Pannoramic SCAN II. For this reason, measures must be taken to eliminate such influences to a maximum possible degree. During periods of non-use, the Pannoramic SCAN II must be protected with a dust cover. Check that power is turned off before you put the cover on.
 Caution!	Do not position the equipment so that it is difficult to operate and to disconnect the device if necessary.
 Crush hazard!	There is crush hazard in the movement area of the slide insert during operation. Please note that the digitizing process has to be interrupted and the insert moved via software to the output position before removing the insert.
 Warning!	A defective Pannoramic SCAN II is not classified as domestic waste. It must be properly disposed in accordance with currently valid legal requirements.
 Warning!	The Pannoramic SCAN II may not be operated by other than properly instructed persons. Operating personnel must be fully aware of the potential dangers which a particular field of application involves. The Pannoramic SCAN II is a precision instrument which may suffer a significant reduction in operational functions or even physical destruction following intervention performed in any nonconforming manner.
 Warning!	If a Lumencor SOLA SM II illumination unit is used, the corresponding warnings included in the manufacturer's operating manual have to be observed.

Notes on Warranty

We at Thermo Fisher Scientific are proud of our quality, reliability and of our after-sales service. We continuously strive to improve our service to our customers.

Please ask a Thermo Fisher Scientific representative about Service Contracts which can keep your purchase in peak condition for many years to come.

Warranty provisions necessarily vary to comply with differences in national and regional legislation. Specific details can be found in the delivery documentation or from your dealer or representative.

Please note that your warranty may be invalidated if:

- This instrument is modified in any way.
- Accessories and reagents which have not been approved by Thermo Fisher Scientific are used.
- The instrument is not operated or maintained in accordance with the instructions in the Operator Guide.

Terms and Abbreviations

CSV	Comma Separated Value
FOV	Field of View
NA	Numerical Aperture
Virtual Slide / Slide	<p>A digital image of a thin glass plate on which specimens are mounted for microscopic study:</p> <p>a dynamic, interactive image that you can manage, save, magnify, zoom, name, evaluate, annotate, mark, comment, send it to a colleague electronically for co-operation or advice, and so on.</p>

1 Product Description

1.1 Product Overview

1.1.1 Intended Use

The Pannoramic SCAN II is designed to use transmitted light and reflected light fluorescence to digitize biological samples and specimens (histological sections, typically).

**Warning!**

After each scanning make sure to inspect the digital slide for over-exposed areas. If the slide is scanned based on improperly set parameters, it can highly affect the results because of information loss.

**Warning!**

Any modification to a hardware or software component of the PC will highly affect the functionality of the scanner program.

1.1.2 Features and Benefits

The Pannoramic SCAN II offers world class brightfield and fluorescent whole slide scanning on up to 9 channels. An outstanding 0.12 $\mu\text{m}/\text{pixel}$ (in Brightfield) and 0.16 $\mu\text{m}/\text{pixel}$ (in Fluorescent) resolution is achieved with the 40 \times /NA 0.95 (equivalent to 80 \times magnification in BF and 62 \times magnification in FL) Plan-Apochromat objective.

Key features of the Pannoramic SCAN II Scanner are:

- A single monochrome camera is used both for Brightfield and Fluorescent scanning
- LED-based RGB illumination unit
- Up to 9 freely selectable color filters for fluorescence
- High-end fluorescent illumination device – Lumencor Spectra 6 Light Engine
- Multiband filter support

- FL scanning with a low noise, 16-bit scientific CMOS pco.edge 4.2 camera
- Software-aided flat-field correction compensation method to create homogenous slide image
- 150 slide automatic loading and scanning
- Improved permanent autofocus
- 3MP camera for barcode reading and preview image
- Image sharpening (both for Fluorescence and Brightfield) feature which improve the visual appearance of digital slides
- Focus algorithm finds the focus which is most appealing to the human eye
- Compact and robust device
- Good quality and stable manufacturing

Pannoramic SCAN II is an optimal choice for customers who need high quality daily throughput granted by the loading capacity of 150 slides.

1.1.3 Warning and Information Labels

The following figure contains the labels used on the Pannoramic SCAN II main unit, the external mains power supply unit, and the Lumencor SOLA SM II illumination unit.

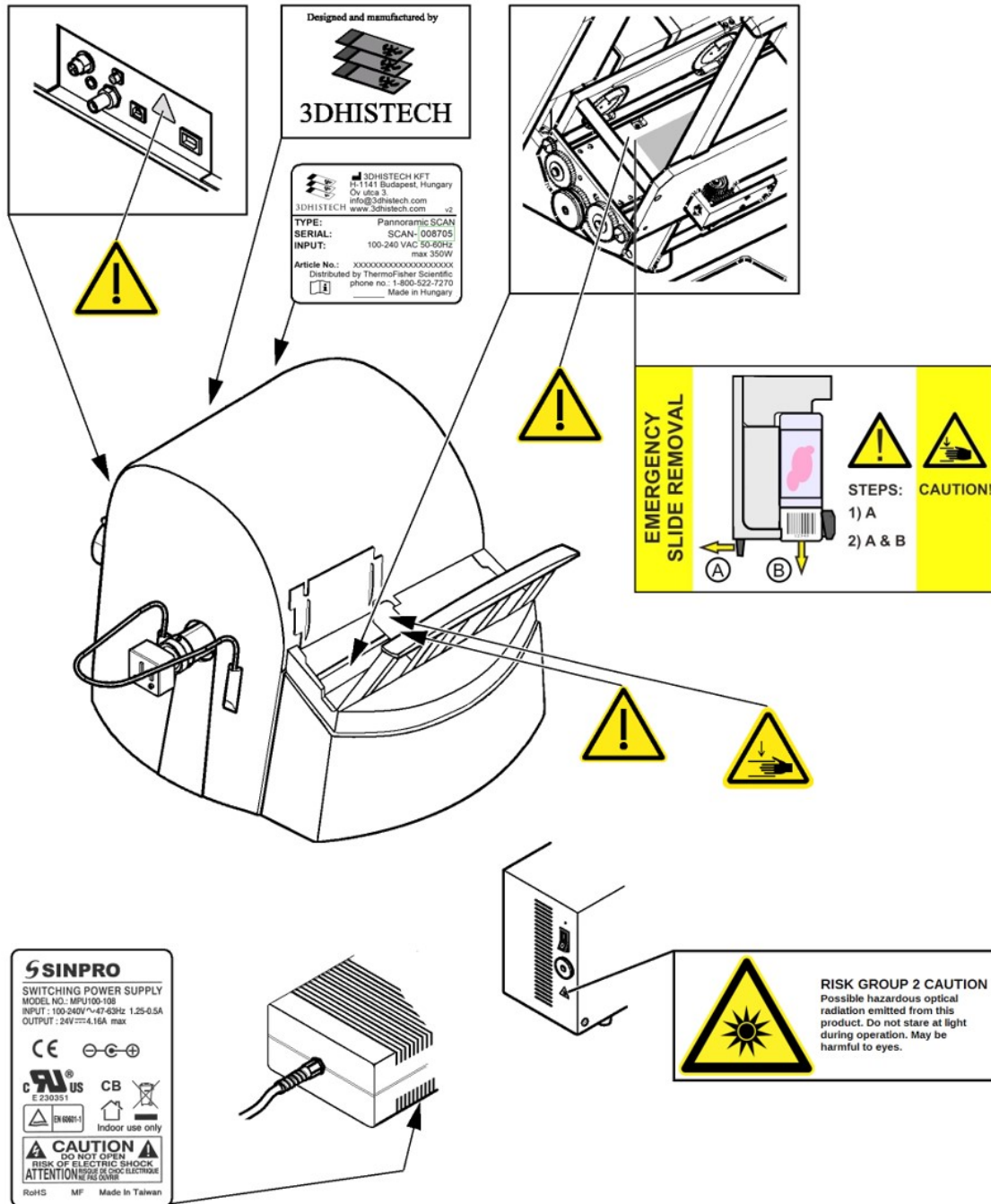

Figure 1 – Warning and information labels

NOTE: The symbol at the feeder slot calls attention to biohazardous materials in use.

1.1.4 Base Unit

The following figure shows the main parts of the base unit.

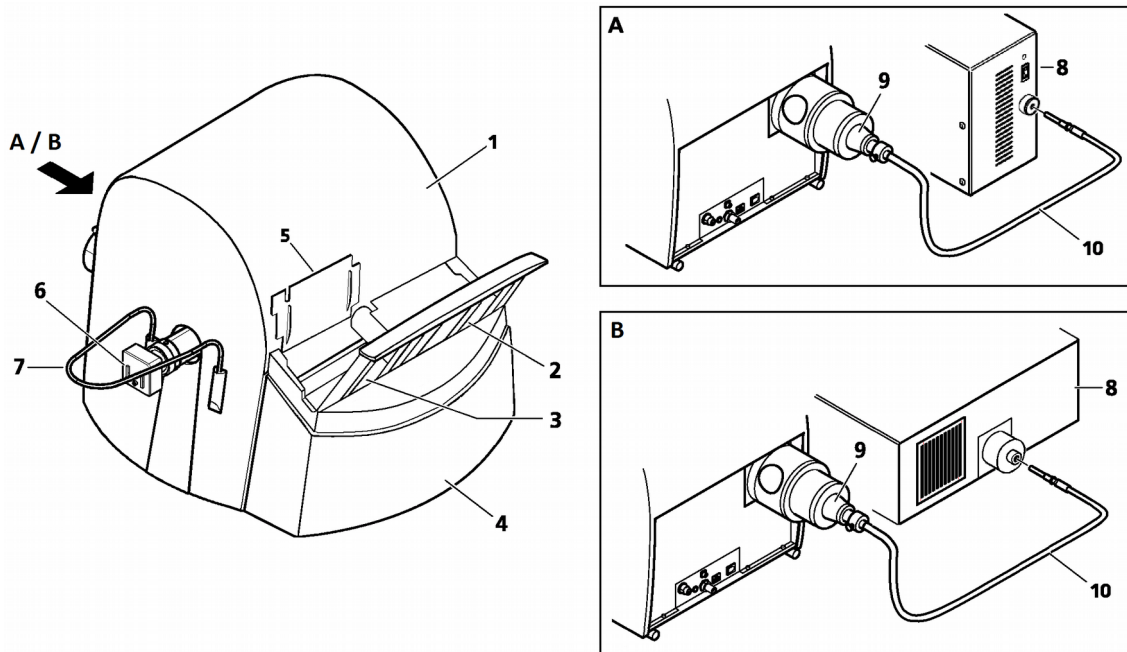

Figure 2 – Main parts of base unit

1. Protective cover
2. Output stack for magazines
3. Input stack for magazines
4. Protective cover for magazine loader
5. Magazine feeder door/cover
6. Point Grey Grasshopper 3 or pco.edge 5.5 camera
7. Protective rails

Fluorescent option A

8. Lumencor SOLA SM II fiber-coupled illumination unit (can be used with Point Grey Grasshopper 3 camera only)
9. Lumencor illumination adapter and cable

Fluorescent option B

8. Lumencor SPECTRA 6 Light Engine fiber-coupled illumination unit

1.2 System Overview

The standard scope of delivery of the product includes the following hardware and software components.

1.2.1 Pannoramic SCAN II system

The following figure shows the main parts of the Pannoramic SCAN II system.

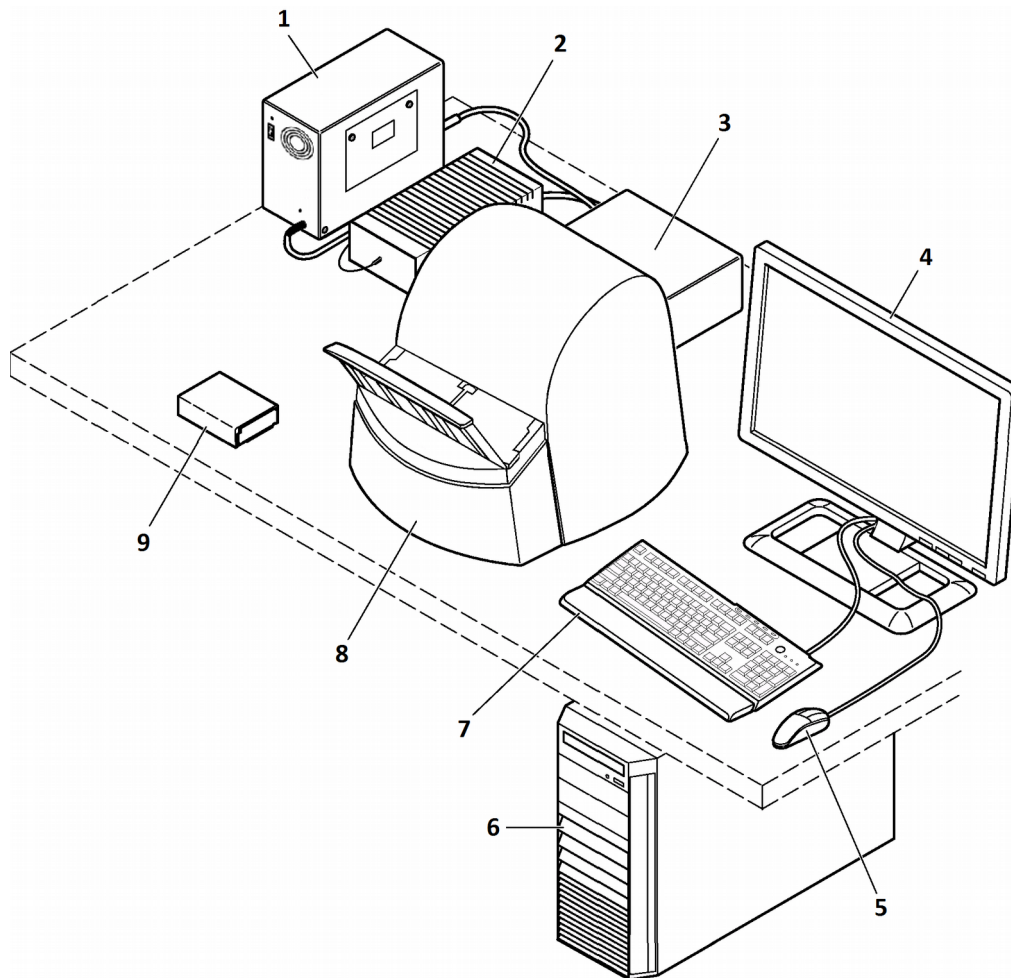

Figure 3 – Pannoramic SCAN II system overview

1. Lumencor SOLA SM II fiber-coupled illumination unit (optional)
2. 24 V external power supply unit
3. Lumencor Spectra 6 Light Engine (optional)
4. Monitor
5. Mouse

- 6. Control computer
- 7. Keyboard
- 8. Pannoramic SCAN II base unit
- 9. Slide magazine with cover

1.2.2 Hardware Options

The configuration of the control computer and monitor can vary depending on the product order.

Cameras

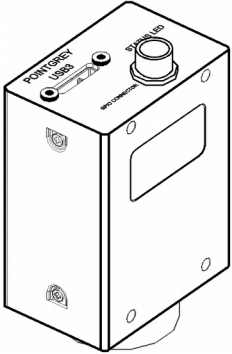
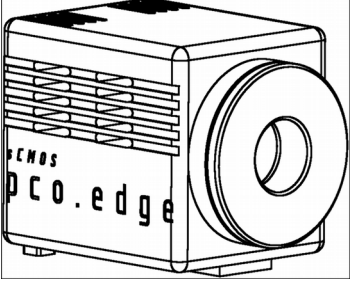
	<p>Point Grey Grasshopper 3</p> <p>1 CCD monochrome camera for high-quality sensitive fluorescent applications.</p>
	<p>pco.edge 4.2</p> <p>Equipped with a high-quality sCMOS image sensor for fluorescent applications allowing fast scanning and an outstanding low read out noise. High quantum efficiency, cooled with Peltier element.</p>

Camera adapters

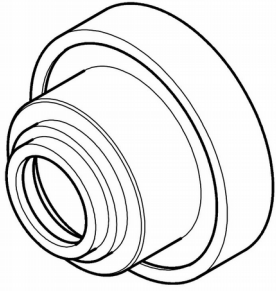
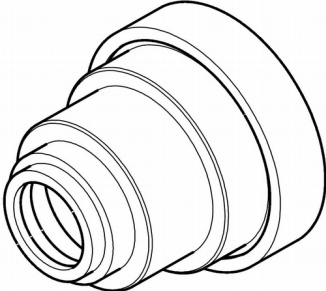
	
<p>0.63× adapter (for Point Grey Grasshopper 3 only)</p>	<p>1× adapter</p>

**Warning!**

The installation of the cameras in Pannoramic SCAN II must be carried out by trained professionals, otherwise the warranty will be automatically voided. The supplier or distributor is not liable for any damages caused by an installation carried out by an unprofessional person.

Base Unit options

- Pannoramic SCAN II Basic Scan Option / Fast Option – base unit equipped with Point Grey Grasshopper 3 camera for Brightfield scanning (no fluorescent accessories included)
- Pannoramic SCAN II Basic Brightfield and Fluorescence Option – base unit completely equipped with Point Grey Grasshopper 3 camera and Lumencor SOLA SM II (non-triggered) or Lumencor SPECTRA 6 fluorescent illumination unit, with filters for fluorescence scanning
- Pannoramic SCAN II Advanced Brightfield and Fluorescence Option – base unit completely equipped with pco.edge 4.2 camera and Lumencor SPECTRA 6 fluorescence illumination unit, trigger cable and filters for fluorescence scanning

NOTE: If Lumencor SPECTRA 6 is ordered, the custom light source and filter modules can be variable. For more information, contact Thermo Fisher Scientific customer service.

Objectives

- Plan-Apochromat 20×/NA 0.8
- Plan-Apochromat 40× Corr/NA 0.95

**Warning!**

Do not change correction collar settings on the 40×/NA objective, if you need it to be set, contact customer service.

Fluorescent Options for Pannoramic SCAN II

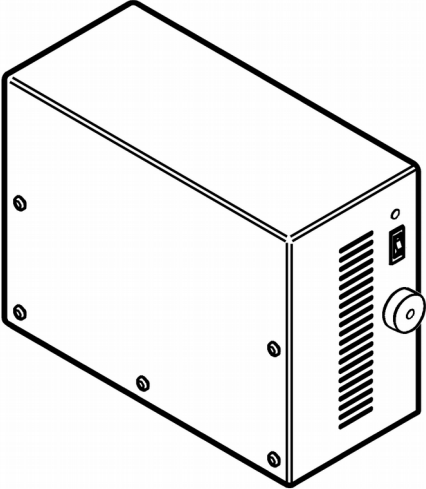
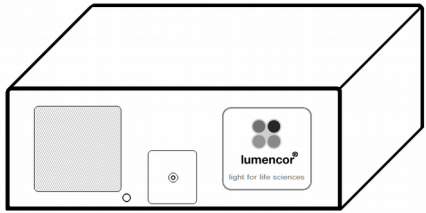
Fluorescent illumination unit	Description
	<p>Lumencor SOLA SM II Fluorescent illumination unit (can be used with Point Grey Grasshopper 3 camera only)</p>
	<p>Lumencor Spectra 6 Light Engine illumination unit</p>

1.2.3 Control Software

Pannoramic Scanner control software

Optional (licensed features):

- Fluorescence
- Extended focus
- Z-stack
- Barcode reader

Pannoramic Viewer software (fully functional)

Optional:

- CaseCenter

- TMA module
- 3D Reconstruction module
- QuantCenter, HistoQuant, NuclearQuant, MembraneQuant, CISHQuant, FISHQuant, and DensitoQuant modules
- TumorBoard module
- E-School Encoder

2 Installation



Warning!

The installation of the Pannoramic SCAN II must be carried out by a trained professional! In any other case the warranty will be automatically voided. The supplier or distributor is not liable for any damages caused by an installation carried out by an unauthorized person.

Only qualified service assistants are allowed to install the hardware and software. The product is ready for use after installation.



Caution!

Make sure that the device is placed so that there is enough space for ventilation and for safe and efficient operator maintenance.

2.1 Control computer ports

The following figure shows the location of the connectors in order to enable easier transportation of the product for a short distance, by disconnecting cables and detaching hardware components from each other.

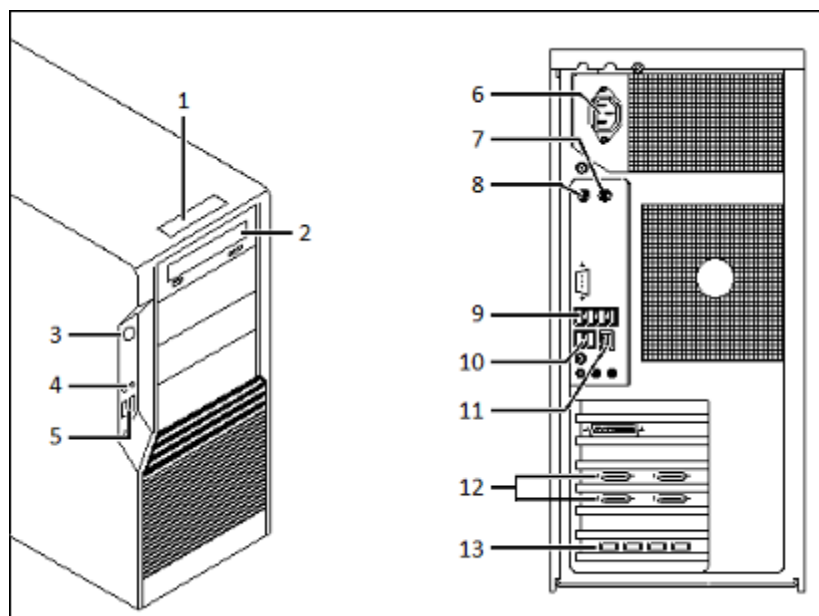

Figure 4 – Ports on control computer

1. Status display
2. DVD drive (RW)
3. Power on/off button
4. Earphone and microphone 3.5mm Jack ports
5. 2x USB port
6. Power supply connector
7. PS/2 mouse port
8. PS/2 keyboard port
9. 4x USB port
10. 2x USB port
11. Network port
12. Matrox Solios CameraLink ports (for pco.edge 4.2 camera)
13. 4x USB 3.0 ports for Point Grey Grasshopper 3 camera

2.2 Connectors and cables



Caution!

It is not recommended to use USB and FireWire cables longer than 2.5 meters.

- Control – USB (between scanner and control computer)
- Preview camera – USB cable (between scanner and control computer)
- Point Grey Grasshopper 3 – USB 3.0 cable (between Point Grey Grasshopper 3 camera and control computer)
- pco.edge 4.2 – a pair of CameraLink cables (between pco.edge 4.2 camera and control computer)
- Video cable (between monitor and control computer)
- Power supply cable (between 230V/110V and monitor)

- Power supply cable (between 230V/110V and Lumencor SPECTRA 6 unit)
- Power supply cable (between 230V/110V and control computer)
- Power supply cable (between 230V/110V and external power supply unit)
- Power supply cable (between 230V/110V and Lumencor SOLA SM II fluorescent illumination unit)
- Power supply cable (between 230V/110V and pco.edge 4.2 camera)
- Optical cable (between Lumencor SOLA SM II fluorescent illumination unit and scanner)
- Trigger cable (between pco.edge 4.2 or Point Grey Grasshopper 3 camera and Lumencor SPECTRA 6 fluorescent illumination unit)
- USB-to-RS232 serial communication cable (between Lumencor SPECTRA 6 fluorescent illumination unit and control computer)

**Warning!**

Only connect external devices that are safety extra low voltage rated to the instrument to avoid the risk of electrical shock.

2.3 Coupling the Lumencor SOLA SM II unit with the scanner

To operate the Lumencor SOLA SM II fluorescent illumination unit, it has to be connected to the Pannoramic SCAN II base unit.

1. Turn the control computer and the Pannoramic SCAN II unit off.
2. Connect both ends of the fiber optic cable to the coupling ports of the scanner and the illumination unit (see **Figure 2 – option A**).
3. Connect power supply cables both of the scanner and the illumination unit.

2.4 Coupling the Lumencor Spectra 6 unit with the scanner

To operate the Lumencor Spectra 6 Light Engine fluorescent illumination unit, it has to be connected to the Pannoramic SCAN II base unit, the camera, and the control computer.

1. Turn the control computer and the pco.edge 4.2 camera off.
2. Attach Lumencor SPECTRA 6 fluorescent illumination unit to the coupling adapter of the Pannoramic SCAN II scanner (see **Figure 2 – option B**).
3. Connect power supply cables both of the scanner and the illumination unit.

4. Connect TTL trigger cable between pco.edge 4.2 camera (out 4) or Point Grey Grasshopper 3 camera and the Lumencor SPECTRA 6 unit (TTL port), and USB-to-RS232 communication cable between the Lumencor SPECTRA 6 unit and the computer.

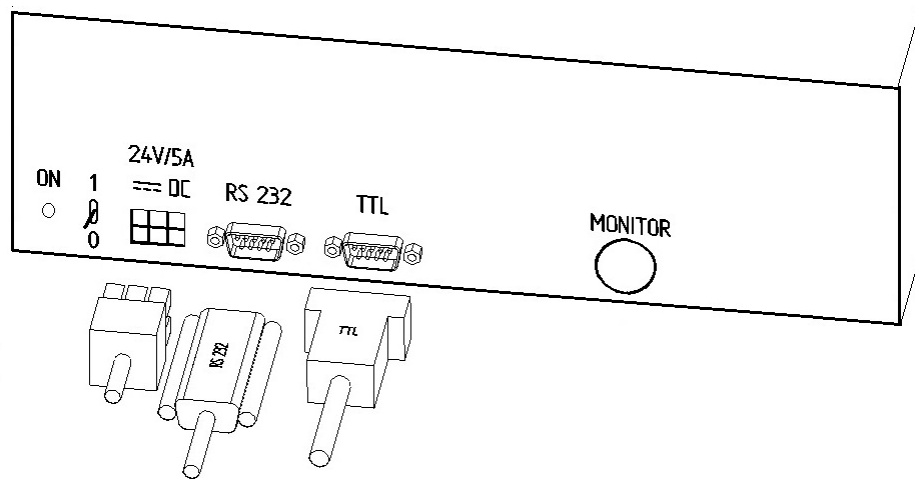

Figure 5 – Lumencor SPECTRA 6 Light Engine connecting ports

3 Operating Slides and Magazines

3.1 Preparing Slides and Magazines

This section demonstrates how to prepare slides and magazines. You can use slides and coverslips that meet the following specifications:

	Slides	Cover slips
Length	75.0 to 76.0 mm	max. 50 mm
Width	25.0 to 26.0 mm	max. 24 mm (recommended: 22 mm)
Thickness	0.9 to 1.2 mm	No. 1 and No. 1.5 (0.13 to 0.16 mm and 0.16 to 0.19 mm)
Corners	45° beveled corners	
Edges	Grounded or cut	



Warning!

Always wear personal protective equipment (safety goggles, gloves and coat) when working with biohazardous material or slides.



Warning!

Do not use a slide when it is broken or its edges are not properly cut or grounded. Using such slides can lead to injury.



Warning!

Ensure that no part of the mounted coverslip protrudes from the edges of the slide. Use slides only with completely dried embedding medium. If not so, the coverslip can be shifted that makes slide loading less reliable. Not completely dried embedding might also influence the operation of objectives and other device parts.



Caution!

Do **NOT** scratch any circular marker onto the glass surface of a slide, use a soft tip pen instead for marking area of interest.

**Note:**

The distance between slide edges and the edges of the mounted coverslip should be 1-2 mm, and they should be parallel with each other.

**Note:**

Fluorescent signals become more easily detectable for the scanner, therefore resulting in a brighter and better image, by treating the slide with a formula that prevents rapid photobleaching of fluorescent reagents (e.g. VECTASHIELD® Fluorescent Mounting Medium by **Vector Laboratories** and ProLong® Gold and *SlowFade*® Gold antifade reagents by **Invitrogen**) during the FISH protocol.

For further information, see the homepages of the manufacturers:
<http://www.vectorlabs.com/> and <http://www.invitrogen.com>.

3.2 Affixing Barcode Stickers to Slides

This section describes how to affix barcode stickers to slides. Barcodes enable virtual slide identification.

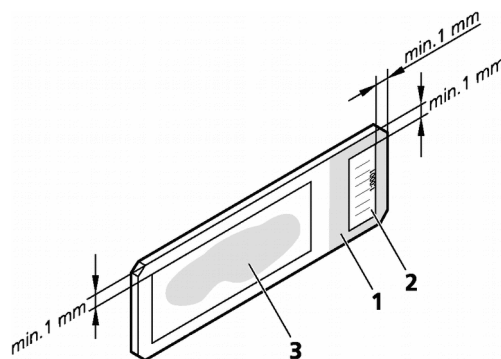

Figure 6 – Slide with a barcode sticker

The label area is recorded by the preview camera, and can be displayed by the control and viewer software.

To affix barcode stickers to slides, do the following:

1. Peel off the barcode sticker **(2)** from the roll.
2. Stick it on the colored label area **(1)** of the slide, on the specimen side.



Caution!

Ensure that a marginal space of 1-2 mm remains on all sides between the sticker and the label area outer limits. It is vital for barcode identification.

Do not let barcode sticker protrude from slide edges, or stick on the coverslip surface **(3)**.

The thickness of the barcode sticker on the slide must not exceed 0.4 mm!

Do not stick more than 4 barcode stickers over each other and the overall thickness must be kept below 1.65 mm (including the barcodes and the slide).

3.3 Inserting and Removing Slides

To insert slides into a magazine

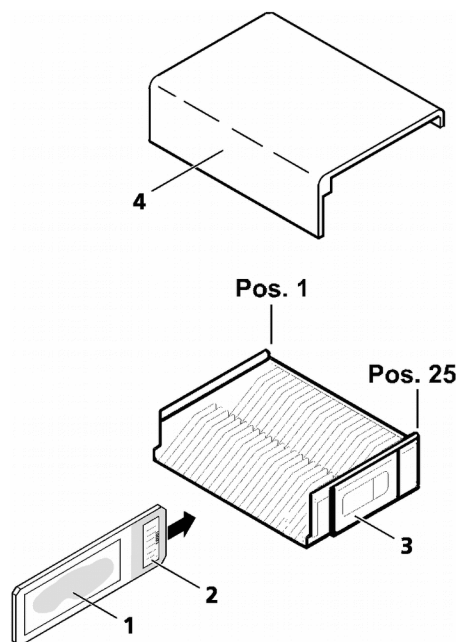

Figure 7 – Inserting slides into a magazine

**Caution!**

Incorrect slide insertion may break the glass. Always make sure that slides are correctly inserted in the magazine. The edge of the broken area of the slide is sharp and its removal can lead to injury and contagion! Broken slide can be removed only by a well-trained person!

The magazines can contain a maximum of 25 slides.

- Push slide **(1)** into the magazine **(3)** with its barcode end **(2)** first. The symbols on the side of the magazine demonstrate the proper way of inserting slides.

**Note:**

You should insert several slides into a magazine without empty slots. Begin the insertion on position 1 of the magazine.

**Caution!**

Only original 3DHISTECH magazines are allowed for use with Pannoramic SCAN II!

To insert or remove a filled magazine from the device, or when transporting it without its cover **(4)**, slightly tilt it to its closed side to prevent the slides from accidentally falling out.

Magazines should always be kept clean from dust, broken glass and other mounting media residues. Slide loader will only operate safely and properly, if magazines are clean.

To insert and remove magazines

Figure 8 – Inserting a magazine

**Warning!**

Do not reach into the input/output stack movement area of the magazine, while magazines are loaded/unloaded. The doors must be closed during operation!

1. Remove magazine cover, before you insert magazines.

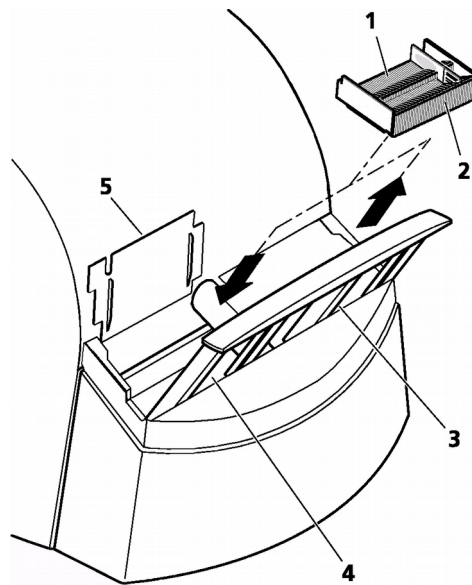
**Caution!**

Replace magazine cover, when magazine is not currently used, or is stored for a longer period. The cover prevents soiling and mechanical damage.

2. Open the door of the input stack (5) and put a magazine (1) into the input stack (4). The magazine's rack (the back side of the magazine) (2) must contact with the guide rails with its open side towards the scanner.
3. Slide down the magazine on the input guide rails until it rests on the guide pins or magazines.

**Caution!**

Make sure that the magazines are not misplaced, because it can cause serious damages in the feeding mechanism.

**Note:**

The input stack can be filled with a maximum of 6 magazines in addition to the one in the magazine loader.

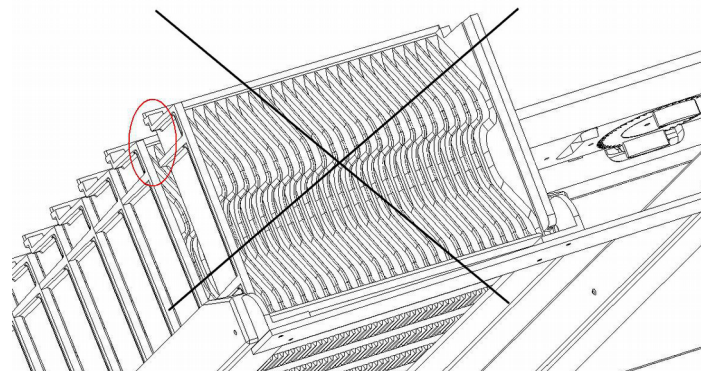

Figure 9 – Misplaced magazine

**Caution!**

Do not place magazines into the output stack **(3)** or remove magazines with already digitized slides from there during the digitization process. Only remove magazines from the output stack when you have finished digitization of all slides.

4 Software Description

4.1 Starting / Exiting Pannoramic Scanner Software

4.1.1 Starting the software

To start the program, double-click on the program icon on the desktop or start it from **Start \ Program Files \ 3DHISTECH \ Pannoramic Scanner**

For the scanning software you can choose from different scanning modes at the startup of the program.

After software initialization the user interface is opened and the mode selection icons are displayed.

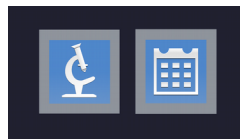

These two mode buttons represent **Microscope** and **Planner** scanner modes:

Microscope mode

- for digitization of individual slide or individual rack
- set scanning profile of the slide
- run Live teleconsultation
- use Live microscope

Planner mode

- plan the entire scanning procedure
- assign one or more profiles to each slide
- define Brightfield and Fluorescence or mixed scanning mode within a run
- define scanning profile to slides included in racks or magazines
- automated scanning mode

After selecting the required mode, the main window is displayed.

4.2 Main window functions

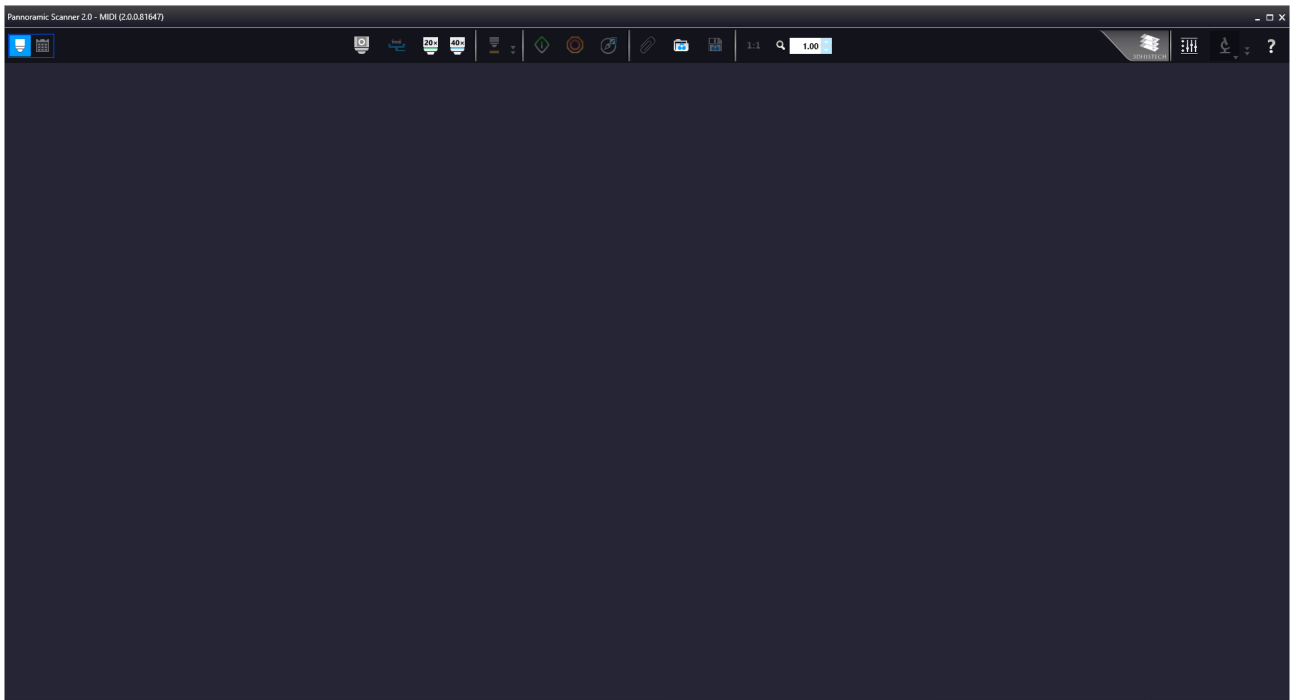
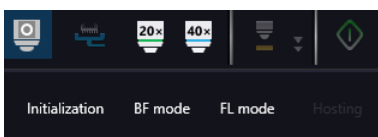



Figure 10 – Pannoramic Scanner 2.0 main window

The following functions are available for you to select from at the main menu bar:

 – **Switch between Microscope and Planner modes**

 – **Microscope initialization**

 **Initialization** – All motors and the preview camera during start-up

 **BF mode** – In BF mode: the camera for brightfield scanning is initialized

 **FL mode** – In FL mode: the camera for fluorescence scanning is initialized

 **Hosting** – Start and host a live Teleconsultation session

 – **magazine/ Slide loading**

Upon clicking the slide icon or entering slide position number at the right side, the slide can be loaded.

Unload the slide by clicking **Unload** next to slide image, and unload the magazine by clicking **Unload** next to the rack image.



If there is a lens marking at the bottom of the position preview in the magazine image, the preview image of that slide has already been created, and if a question mark is displayed the slide was not yet loaded. A hatch and lens marking represent a slide that is loaded at the moment.

Emergency Position: If a slide has been jammed in, the unloading position where the magazine should be moved can be defined.

Slide removed: Click this button to inform the control software that the slide has been removed manually.



– Objective changer



– Live view is on



– Live view is on with the shutter closed



– Toolbar for live images

- The toolbar is only available for the displayed live image, but not available for camera images during digitization.
- One pixel on the monitor corresponds to one pixel on the camera
- The live image completely fills the display area
- Displays or hides the vertical and horizontal scale bars
- Displays the magnifier window
- Activates red marking on overexposed pixels
- Saves the current image as BMP or JPEG file

Fast live mode – live images are displayed with a frequency of at least 10 images per second. If an exposure time is set to more than 100 ms, the pixel values are multiplied accordingly (for example, if

an exposure time of 200 ms is set, the pixel values are multiplied by 2, and the exposure time is reset to 100 ms). Therefore the resulting images will have a higher noise level.

This function is useful for fluorescent live view where in spite of the higher noise level, the resulting image will be refreshed as in normal mode.

Normal live mode – images are taken with the user-specified exposure time.





- Fast Mode 

- Screenshot 

- Magnifier Window 

- Ruler 

Image Processor Plugin functions: 

-  : Convolute gray-scale image by custom kernel
-  : Multi-channel histogram with normalization
-  : Invert image (for testing purposes)
-  : Mark overexposed pixels

Scan Properties  (included as well on the profile cards added to the slide in Planner mode) unique settings can be defined even for each separate scanning.

- **Scan to Local**
 - Select the Slide save Path
 - Folder from Barcode
 - Free space: Free space capacity of selected local drive
 - Use Barcode
 - Slide name: Can be defined by manual or generate automatically with **Generate name** setting.

- **Scan separately:** The FOV areas of the preview image will be scanned and saved separately as discrete digital slides.

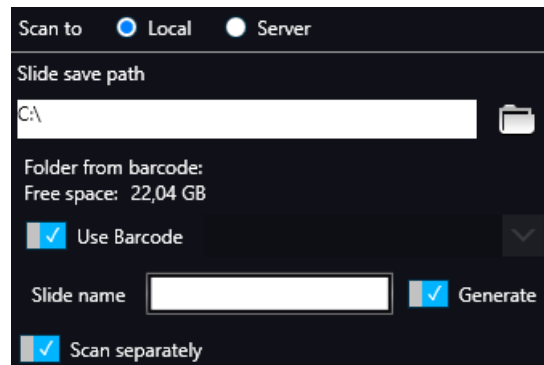

Figure 11 – Scan Properties window

- **Scan to Server**

- **Server:** the drop-down list includes all the saved servers. Click **Add new item ...** to create another server connection.

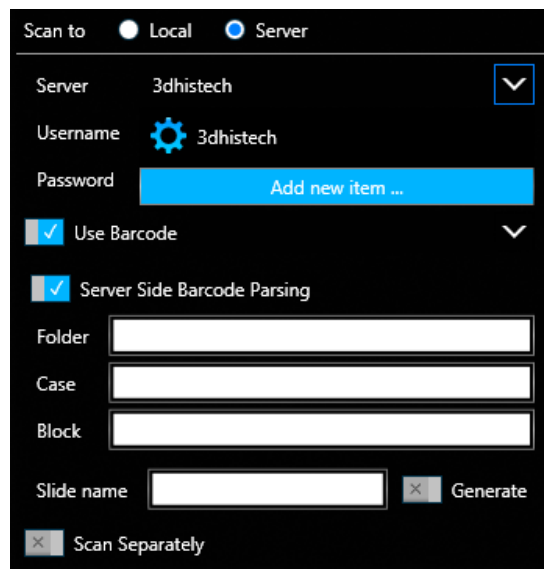

Figure 12 – Scan to server settings

- **Server Editor:** The user define here the following details of the Server:
 - **Display Name**
 - **Host Name**
 - **Protocol**

Server Editor stores each of the created server in a list. List entries can be removed or a new entry can be added if required. With the **Filters** function you can narrow down the results by searching for a specific server data. By double-clicking a list item, server data will be loaded in the **Scan to Server** panel.

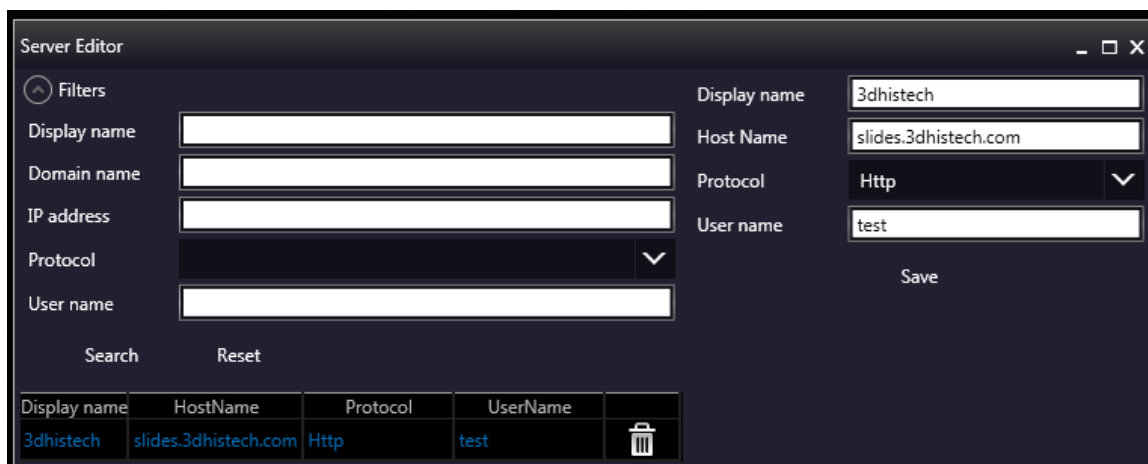
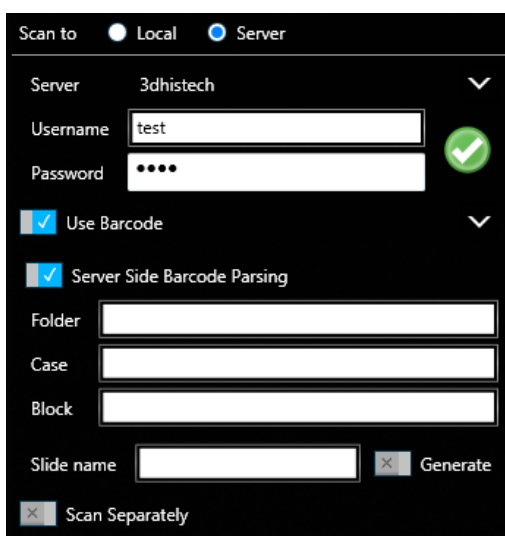

Figure 13 – Window of server editor

After loading server data, user name and password is required to be added for authentication and accessing the server. If connection is successful, a green checkmark is displayed in the window.



- **Use Barcode:** Barcode settings can be modified in the Barcode Editor window. By predefining barcode type and other settings.
- **Server Side Barcode Parsing** option can be selected if CaseCenter is connected with the supported HIS/LIS. This way the barcode read by the software is being identified, and the predefined location of that specific case in CaseCenter is automatically selected as scanning destination based on the CaseID (containing slide and patient data stored on HIS/LIS). Therefore, **Folder**, **Case**, **Block**, and **Slide name** field data cannot be modified, only a profile can be selected.

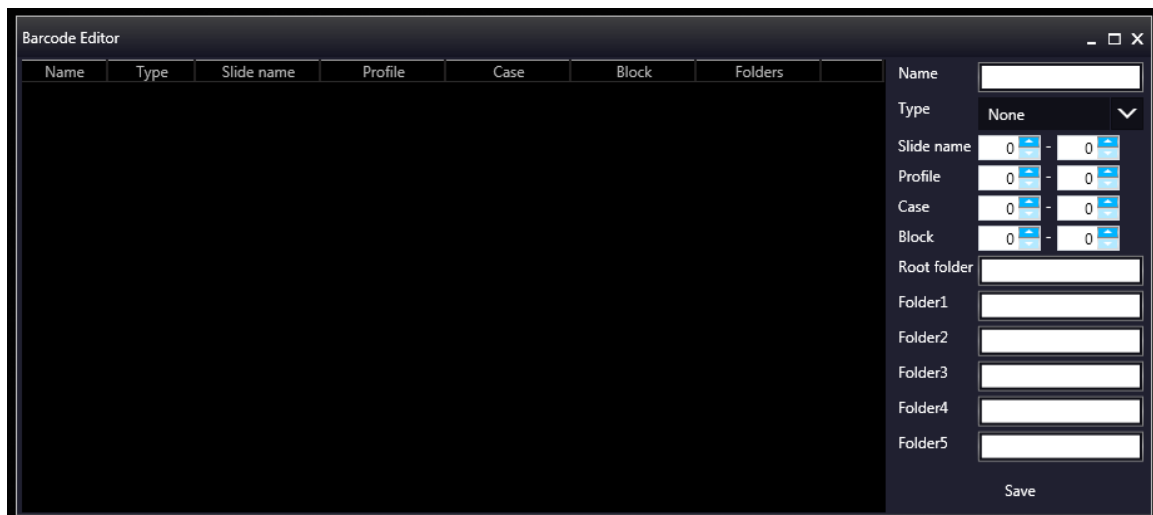

Figure 14 – Window of Barcode Editor

You can select the following barcode types:

1D barcode types

- *Code 39
- Code 128
- Code 16K
- *Interleaved 2 of 5
- Standard 2 of 5
- IATA 2 of 5
- Matrix 2 of 5
- Telepen
- Code 93
- Code 11
- MSI
- Codabar
- Patch Code
- Pharmacode
- EAN-13
- EAN-8
- UPC-A
- UPC-E

2D barcode types

- Aztec
- Data Matrix
- PDF417/Compact
- Micro PDF417
- QR
- Micro QR
- MaxiCode



– **Start Scan**

Scanning of the actual slide or performing the whole previously planned scanning procedure can be initiated.



– **Stop Scan**



– **Stop actual progress**



– **Take All Preview**

Each preview of slides in the magazine is taken automatically. Preview types are the following:

- Brightfield
- Pre-Scan (FL)
- Pre-Scan High-Resolution (FL)
- Pre-Scan + High-Resolution (FL)

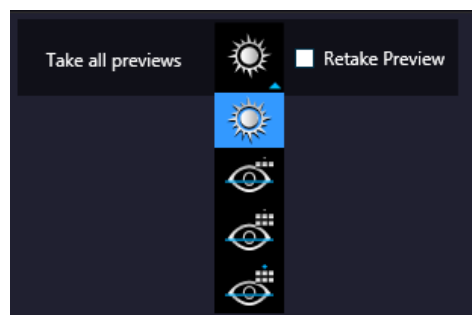

Figure 15 – Take all preview selector



– **Auto attach**

Actual profile is assigned to the loaded slide automatically.

 – Open profile

The Profile Browser window containing a list of previously saved profiles is opened. Based on the Illumination type, profiles are grouped into two clusters: Brightfield and Fluorescence. Additional profiles can be created here as well, and you can also search for a specific profile by filtering based on the following data:

- Objective type
- Multilayer mode
- Illumination
- Filters
- Modify date
- Last use date

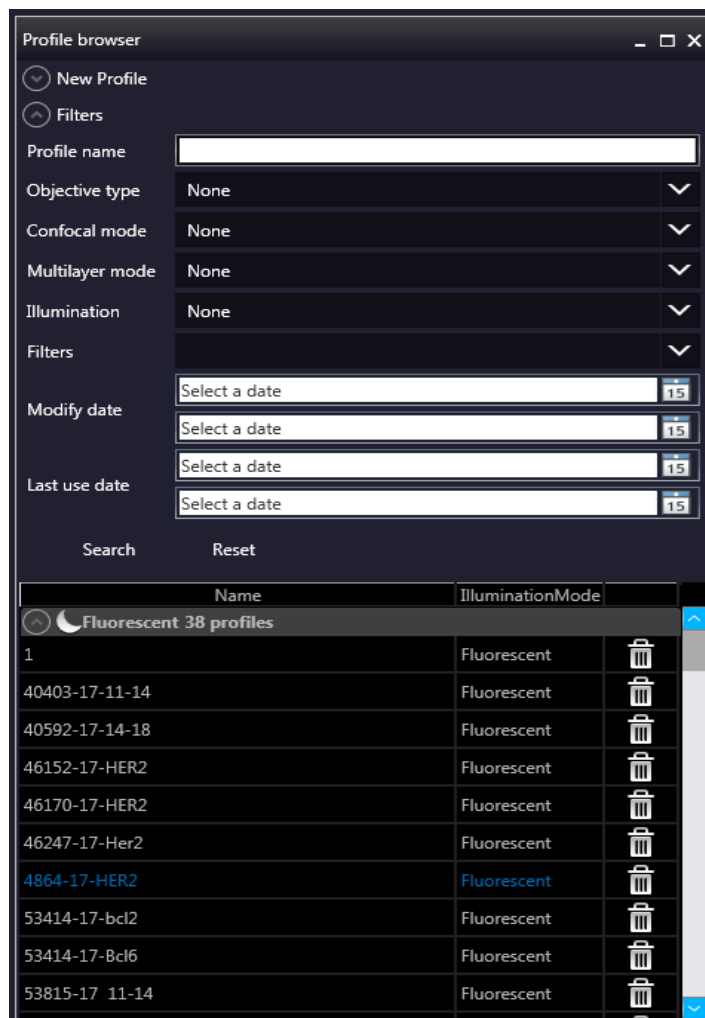
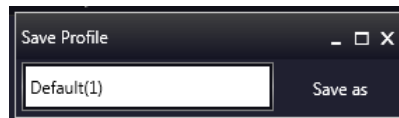

Figure 16 – Profile browser window

 – Save Profile

The selected profile can be saved in this window after typing the profile name into the text field and clicking **Save as**.



 – Reset Zoom

This function is active only in Live view at 1:1 magnification.











 – Live image magnification

 – Preferences



This panel contains user settings that have global effect on the GUI and some of its functions.



Appearance settings

- **View Mode Selector**
 - Text mode 
 - Icon mode 
 - Float Text mode 
 - Float Icon mode 
- **Style selector**
 - Black Jelly 
 - Flat style 
 - Black Jelly P1000 
 - Flat style P1000 
- **Planner style editor**
 - Slides with card 
 - Table 
 - Card Collection 

Live mode

- **Rendered**  – live image is displayed in an embedded window
- **External legacy**  – live image is displayed in an external window

Profile settings

- Use profile history save – With this function each profile modification is saved in Profile History from which the different stages can be reloaded.
- Save interval – Profile content is automatically saved at the specified time-frames.
- Enable setting of focus time – Parameters (**Short / Normal / Long**) related to focus time will be enabled on the profile settings panel. **Normal** is set as default.

Slide settings

- Take preview automatically – This function is designed to take preview images of slides automatically, once they are loaded.
- Unload slide after FL grabbing
- Slide label anonymity – Slide label area is displayed as a clear white image during scanning, patient data will not be visible in CaseViewer.
- Do not save label to slide – The original label area is not saved to the slide, and will not be visible in CaseViewer.
- Calculate exposure time for barcode grabbing – Three images are recorded for barcode image creation. Exposure times will be recalculated each time, thus creating perfect light conditions for barcode reading, so to make sure that barcode identification is successful.

Scanning History

- Hardware log 

Scanner hardware operations are contained in this log. To enable this function, first the database from the following folder must be loaded: C:\ProgramData\3DHISTECH\SlideScanner\HWLogDataBase

The following motor movements are recorded in the log list:

- Camera Changer
- Confocal
- DFP Light
- Filter Wheel
- Flash Light
- General
- Halogen Light
- Microscope Part
- Midi Loader
- ND
- Objective Changer
- Preview Light
- RGB Light
- Relay
- Scan Loader
- Service

- Shutter
 - Slide Scanner
 - Stage
 - Waterpump
- Software log 

All of the circumstances and states of the slide scanning procedure is saved. LogID is the sequence number of scanning performed on the scanner in use. (Profile Name, Illumination mode, Scan type, Scan Start, Scan Finished, URL, Error)

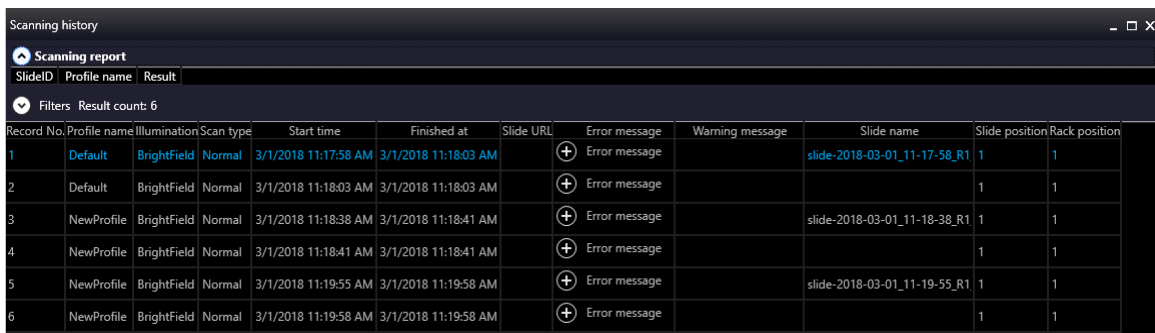

Record No.	Profile name	Illumination	Scan type	Start time	Finished at	Slide URL	Error message	Warning message	Slide name	Slide position	Rack position
1	Default	BrightField	Normal	3/1/2018 11:17:58 AM	3/1/2018 11:18:03 AM		Error message		slide-2018-03-01_11-17-58_R1	1	1
2	Default	BrightField	Normal	3/1/2018 11:18:03 AM	3/1/2018 11:18:03 AM		Error message			1	1
3	NewProfile	BrightField	Normal	3/1/2018 11:18:38 AM	3/1/2018 11:18:41 AM		Error message		slide-2018-03-01_11-18-38_R1	1	1
4	NewProfile	BrightField	Normal	3/1/2018 11:18:41 AM	3/1/2018 11:18:41 AM		Error message			1	1
5	NewProfile	BrightField	Normal	3/1/2018 11:19:55 AM	3/1/2018 11:19:58 AM		Error message		slide-2018-03-01_11-19-55_R1	1	1
6	NewProfile	BrightField	Normal	3/1/2018 11:19:58 AM	3/1/2018 11:19:58 AM		Error message			1	1

Filtering for the following parameters is available:

- Scanning date
- Profile name
- Illumination mode
- URL
- Slide name
- Slide index
- Rack index

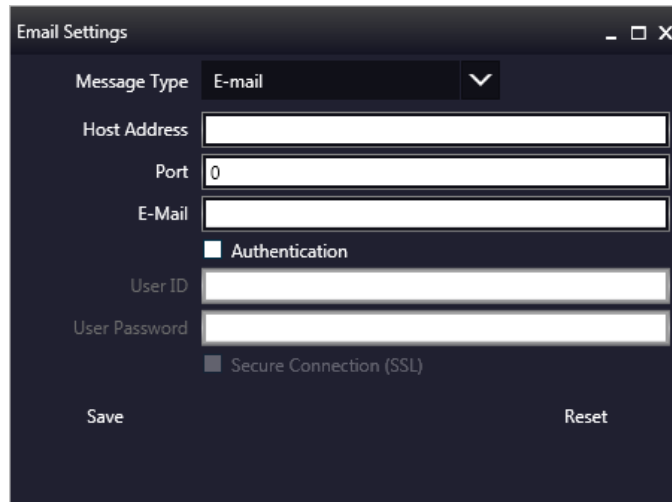

Email Settings

An e-mail can be sent automatically about every failure and error that is occurred during scanning to the specified address. The log files are compressed into a ZIP file, that is attached to the mail.



5 Scanning modes and settings

After microscope initialization, if FL HW option is provided, you can select from the following two modes:

- **Brightfield scanning mode** (see section *5.1 Brightfield Scanning Mode* for more information)
- **Fluorescence scanning mode** (see section *5.2 Fluorescence Scanning Mode* for more information)
- **Option modes**
 -  **Off**
 -  **Services** (see section *5.6 Services and Settings* for more information)
 -  **Settings** (see section *5.6 Services and Settings* for more information)

In accordance with the selected mode, the **Profile Settings Panel** and the **Microscope Control Panel** views are modified.

5.1 Brightfield Scanning Mode

Microscope View consist of three different sections:

- **Main functions:** Located at below the window header, these functions are identical in both modes.
- **Profile Settings panel:** Profile settings containing parameters used for scanning.
- **Microscope Control Panel:** Live microscope movement functions

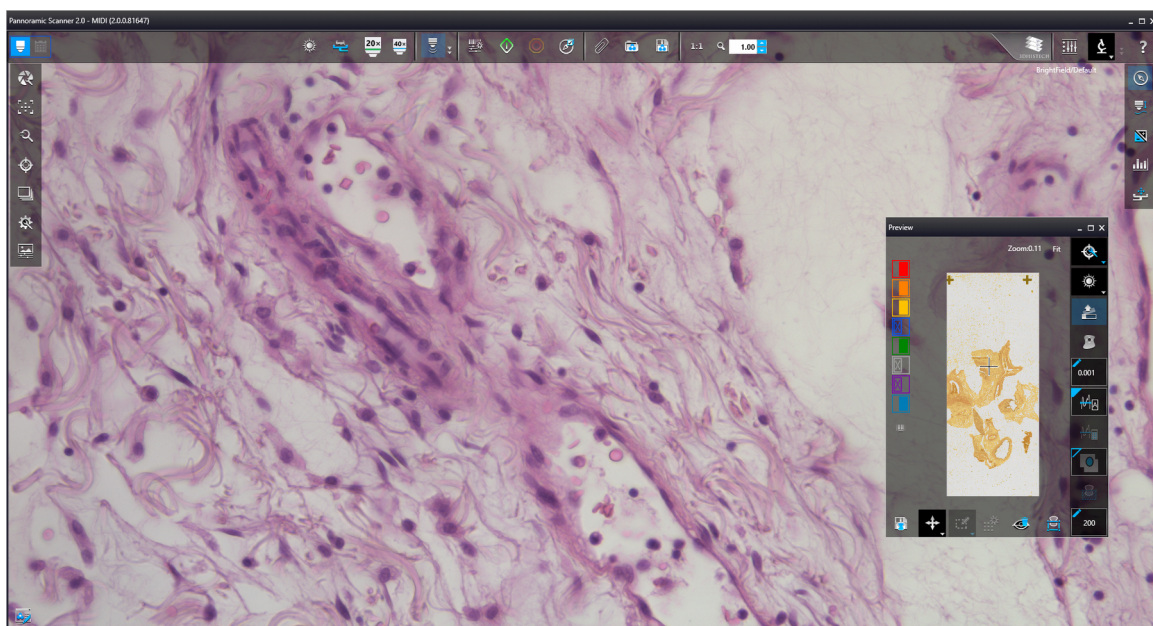

Figure 17 – Main window of Brightfield Microscope mode

5.1.1 Profile Settings Panel



Objective settings

This field displays the objective used for scanning. Objective type: 20x; 40x

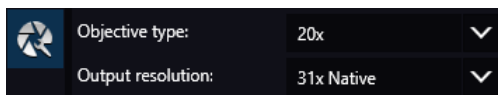

Focus settings for the scan profile



Figure 18 – Focus settings for scan profile

- **Limit the range:** You can define focus limits by selecting **Limit the range** for focusing. You can set the upper and lower limits by selecting the desired value in the selection boxes. This is useful if focusing was not targeted on the specimen, but on a spot on the coverslip.
- **Focus distance:** the distance of focal points can be set to create a focus map, based on which the software calculates interpolated focus values (one step in distance means one FOV).



Sample detection

This panel offers options for threshold setting and selection of the area to be scanned.

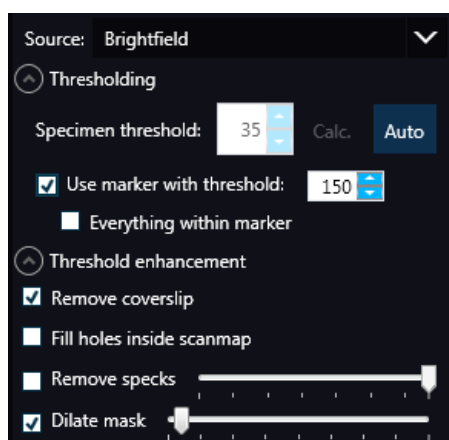

- **Source:** Brightfield preview – a normal type of illumination in the microscope for scanning the slide. This option is recommended when scanning in Brightfield mode.

- **Thresholding:** The manually specified value is used for thresholding during scanning. Preview image of the loaded slide is displayed in the Preview window, and when modifying any of the parameter values, it will have effect on the preview image. If the threshold value presented on the Microscope Controller preview window is modified, this value is automatically applied by the profile in the Profile Settings panel.

- **Specimen threshold**

This value is definable manually: This sets the sensitivity of the specimen detection. To set the desired threshold value manually, change the setting in the **Specimen threshold level** selection box in the range of 0-255. The default value is 220. Smaller values result in a more sensitive scanning, meaning that more areas will be digitized, however, this may also include specks or other imperfections of the slide. Greater values result in a less sensitive scanning, but it is possible that some of the smaller specimen areas will not be digitized.

- **Auto Threshold**

By clicking  the specimen will automatically be detected in the preview image.



Caution!

Make sure that the detection result is acceptable for you. Otherwise, set the threshold value manually or append missing areas with the help of appropriate functions in the **Preview** window.

- **Use marker with threshold**

If the specimen cannot be identified as required for digitization, (for example, weak contrast), it can help to encircle completely the specimen with a black marker pen. You have to draw a full circle with the pen to enable the detection. Marker pen detection will make specimen detection easier by limiting the scanned area. If this option is selected, only the area encircled with a marker pen will be scanned. You can define the threshold level by changing the threshold value in the **Use marker with threshold** selection box in the range of 0-255. This sets the sensitivity of the specimen detection inside the marker area. To set the desired threshold value manually, change the setting in the **Specimen threshold** selection box in the range of 0-255. The default value is 105.

- **Everything within marker**

To scan everything within the marked area, check the **Everything within marker** selection box.

Alternatively, click  in the preview window to activate this function.

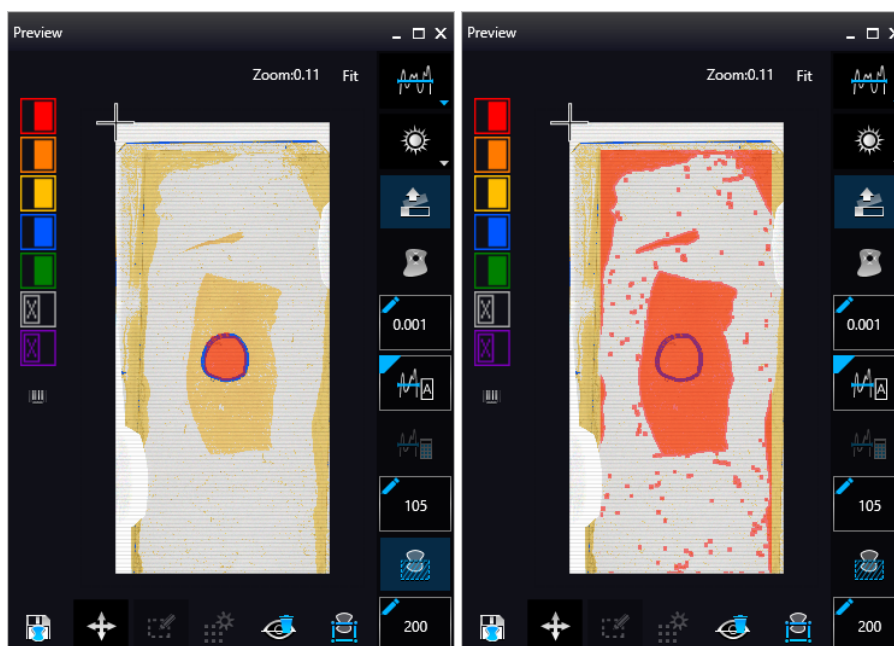

Figure 19 – Scan everything within the marked area (selected / not selected)

- **Threshold enhancement**

- **Remove coverslip** – If selected, the edges of the coverslip are not detected as specimen to be scanned. Depending on the threshold level, it is possible that the edges of the coverslip are detected as areas to be digitized.

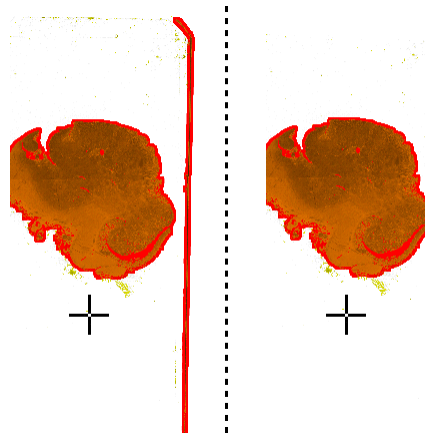

Figure 20 – Preview image with and without coverslip edge



Caution!

It requires lots of time (since it cannot find focus neither on the edges, nor on specks) to digitize coverslip edges. Select **Remove coverslip** function to eliminate those areas.



Warning!

Do **NOT** use **Remove coverslip** function on TMA slides! The layout of TMA slides may mislead the detecting algorithm.

- **Fill holes inside the scanmap** – If selected, the holes inside the specimen will also be scanned. Often these holes contain small sample objects that otherwise would not be scanned.
- **Remove specks** – If selected, the scanner does not digitize objects smaller than the predetermined size. This helps filtering specks and other uninteresting objects out. Set the maximum size of specks not to be digitized by adjusting the slider.
- **Dilate mask** – Adjust the slider to enlarge or decrease the scanned area. The edge is extended discretely by 100 μm each time.



Scanmap

A previously saved scanmap can be loaded and applied.

- **Use Threshold:** Preview settings defined in the Microscope Controller Panel / Preview window are applied as the basis of scanmap.
- **Load scanmap:** This function is useful if the slides contain areas of interest that cannot be detected by the preview camera. This function along with saving profiles helps to scan all slides with the most adequate settings.
- To load a mask, click **Load**. It will display a drop-down menu. Select whether to load preview mask or TMA grid.
- **Custom scanmap:** The scanmap draws manually on the preview image is used for scanning.



Use selection box restriction

If selected, only the area inside the box is scanned. It is useful if you only want to scan the area that is equivalent with the size of the coverslip, so external specks will not be scanned.



Multilayer mode

- **Single layer mode:** Select **Single layer** option if you want to scan a single layer of the slide.
- **Extended focus:** By choosing the **Extended focus** option, the software selects the sharpest image from each focus level for each image field, and combines them into one single image. Therefore those parts that were blurry in auto/manual focus will also be sharp. This method guarantees the maximum depth of sharpness, however, it reduces digitization speed.

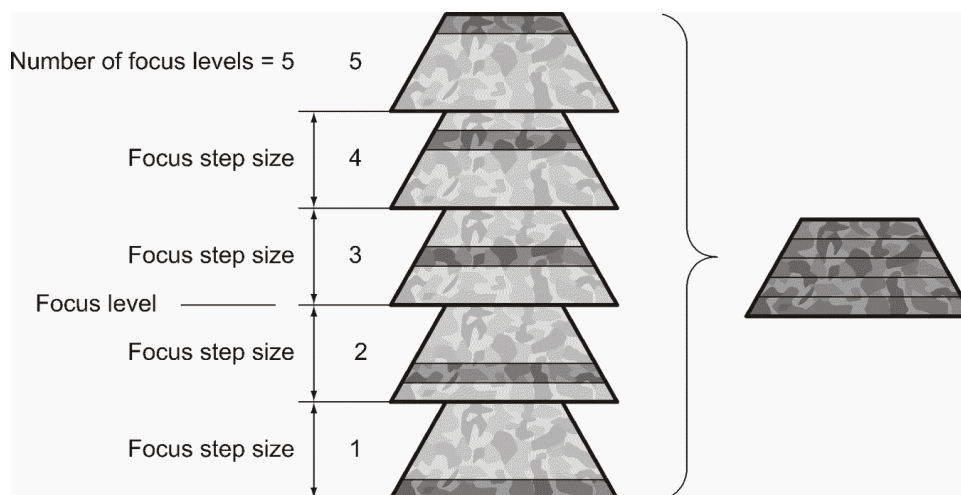
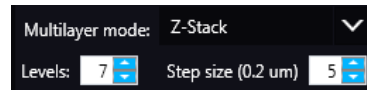

Figure 21 – Focus level and step size

- **Z-stack scan mode:** Both for Extended focus and **Z-Stack** scanning methods, you can determine the desired number of focus levels with the **Levels** selection box. The current focus value is the starting point. If you set 5 for example, one current, two focus levels above and below FOVs are captured. Therefore, it is advised to choose an odd number for the focus levels. Separate layers are created and stored this way, and can be opened with Pannoramic Viewer. The Z-stack slide contains the extended focus layer.



Step size determines the spacing between focus levels. One step is around 0.2 μm .

Default settings are: **Levels: 7; Step size: 5.**



Scanning Settings

Includes the **Stop and Go** scanning mode.

Use Color matrix: Select an applicable preset color profile to be used for Brightfield scanning from the drop-down menu. Settings according to the profile has effect on the color set, color temperature, and gamma value of the scanned image.

Separate color matrix can be defined and used for each profile and scanning.

Preset profiles are the following:

- **Calibrated Linear:** Color scheme is defined by calibration (Gamma value is not included)
- **sRGB standard:** Color scheme is defined by calibration (standard Gamma value -2.2- is applied)
- **sRGB standard Microscope Like:** Color scheme is defined by calibration (standard Gamma value / White Point: D50)
- **Legacy:** a Color scheme calibrated for the previous software version is applied
- **Custom:** Color profile set in Service is applicable if needed.



Image settings

You can choose the following predefined image formats (and a subsequent custom option) from the **Image Quality** drop-down list in the **Image Encoding** section of the window:

- Excellent (JPEG: 90)
- Good (JPEG: 80)
- Medium (JPEG: 60)
- Low (JPEG: 30)

- Custom...

If choosing this option, the Image compression setting is displayed on which you can select from different image formats. Accordingly, further adjustments can be made, except if PNG or BMP image format is selected.

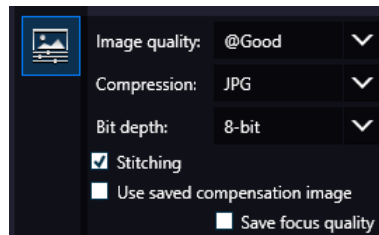

Figure 22 – Image encoding window

- **JPEG** – The quality can be adjusted with the **JPEG quality factor** slider. Greater values result in better quality, but larger files. The default setting is 80%.
- **PNG** – Lossless compressed image format.
- **BMP** – Lossless uncompressed image format, but larger files due to less effective compression. It is a raw data file.
- **Stitching:** Use Stitching function enables the seamless stitching of digital tiles.
- **Use save compensation image:** The **Use saved compensation image** function enables the use of previously recorded reference images for all slides. Use this function when the slide is completely covered by the specimen (for example, blood smear) thereby making compensation image capture impossible. For such slides, use an empty slide with coverslip to grab a compensation image. If you select this, the software will not create new compensation images for each slide. Compensation images are reference images used for white balancing and shading.
- **Save focus quality:** The measurement of focus quality (correctness of average focus on layers) is saved. This option is inactive when **Extended focus** option is activated.
- **Save image in original Bayer size** function is only available if pco.edge 4.2 camera is installed on the scanner. It is not accessible for configurations installed with Point Grey Grasshopper 3 camera. Image fields will be saved with native pixel resolution. If this function is disabled, you will work with reduced pixel resolution. These resolution differences are not really visible with the human eye, what is important in this feature is the resulting smaller file size.

5.1.2 Microscope Control Panel

The Microscope Control panel includes the main control features of the microscope.

5.1.2.1 Preview Window

The Preview panel offers options for threshold setting and selection of the area to be scanned.



Figure 23 – Preview panel

Threshold options

This section is located at right side of the preview window. **Scanmap Source** is designed to set which type of scanmap is used on the preview image. This scanmap is displayed automatically in the **Profile Scanmap Source** setting. Selectable scanmap types are the following:

- Use threshold 
- Load previously saved scanmap from file 
- Custom scan map 

Preview Type setting determines the type of illumination. In Brightfield mode, the following preview types are available:

- **Brightfield preview**  – a normal type of illumination in the microscope for scanning the slide. This option is recommended when scanning in Brightfield mode.

Remove Coverslip  – If selected, the edges of the coverslip are not detected as specimen to be scanned. Depending on the threshold level, it is possible that the edges of the coverslip are detected as areas to be digitized.

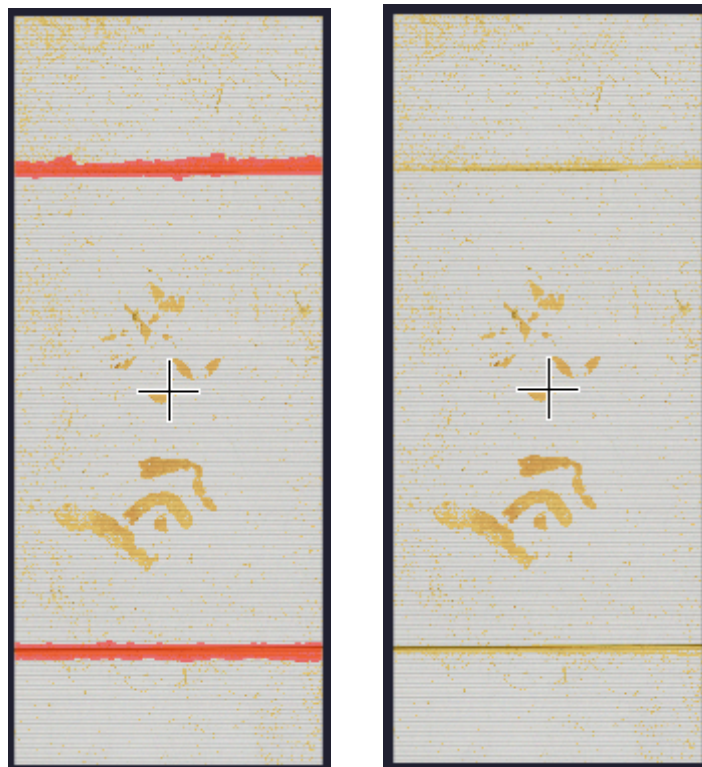

Figure 24 – Preview image with and without coverslip edge





Caution!

It requires lots of time (since it cannot find focus neither on the edges, nor on specks) to digitize coverslip edges. Select **Remove coverslip** function to eliminate those areas.

**Warning!**

Do **NOT** use **Remove coverslip** function on TMA slides! The layout of TMA slides may mislead the detecting algorithm.

Fill holes inside scanmap : If selected, the holes inside the specimen will also be scanned. Often these holes contain small sample objects that otherwise would not be scanned.

Remove specks : If selected, the scanner does not digitize objects smaller than the predetermined size. This helps filtering specks and other uninteresting objects out.

Set the maximum volume of specks manually in the setting window .



Threshold settings have two different statuses:

- **Auto threshold** : It automatically detects the specimen in the preview image.

**Caution!**

Make sure that the detection result is acceptable for you. Otherwise set the threshold value manually.

Make sure that the detection result is acceptable for you. Otherwise set the threshold value manually.

- **Manual threshold** : Set threshold value manually, or calculate value on the actual preview with **Calculate Threshold**  function which is active only if setting the value manually. This sets the sensitivity of the specimen detection. To set the desired threshold value manually, change the setting in the **Specimen threshold level** selection box in the range of 0-255. The default value is 212. Smaller values result in a more sensitive scanning, meaning that more areas will be digitized, however, this may also include specks or other imperfections of the slide. Greater values result in a less sensitive scanning, but it is possible that some of the smaller specimen areas will not be digitized.

Use marker with threshold  : If the specimen cannot be identified as required for digitization, (for example, weak contrast), it can help to encircle completely the specimen with a black marker pen. You have to draw a full circle with the pen to enable the detection. Marker pen detection will make specimen detection easier by limiting the scanned area.

- **Manual setting of Use marker with threshold**  : If this option is selected, only the area encircled with a marker pen will be scanned. You can define the threshold level by changing the threshold value in the **Marker threshold level** selection box in the range of 0-255. This sets the sensitivity of the specimen detection inside the marker area. To set the desired threshold value manually, change the setting in the **Threshold** selection box in the range of 0-255. The default value is 212.

Everything within marker  : This function is available only to select if the **Use marker with threshold** function is activated. To scan everything within the marked area, check the **Scan everything within marker** selection box.

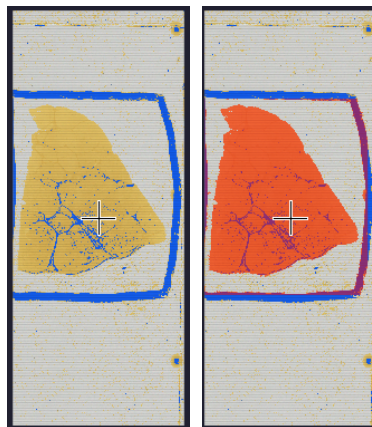









Figure 25 – Scan everything within the marker selected / not selected

Dilate mask  : Adjust the slider to enlarge or decrease the scanned area. The edge is extended discretely by entering a new value each time. To switch to manual mode click the top left corner of the button and the required value can be entered in the box .

Preview Toolbar



This section is located at the bottom of the preview image.

- **Save scanmap**  – Click this icon to save the currently selected areas to scanmap.
- **Position sample**  : To position the specimen holder that holds the current slide, click **Position sample** and then click on the area of interest on the preview image. This will define the Live image that you can access from the **Live view** .
- **Union**  : Add the selected areas to the preview. Mark area for scanning based on the shape selected in the Preview Toolbar. This area will not be scanned.
- **Erase**  : Delete selected areas from the preview image. Deselection is made based on the selected shape from the Preview Toolbar. This area will not be scanned.

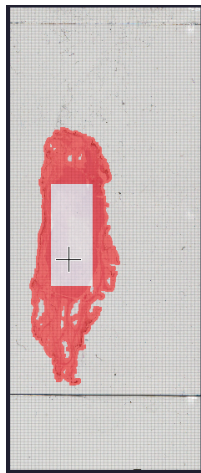



Figure 26 – Not scanned selection

- **Edit**  : The size of selected area (positive or negative) can be modified at the borderlines or corners.

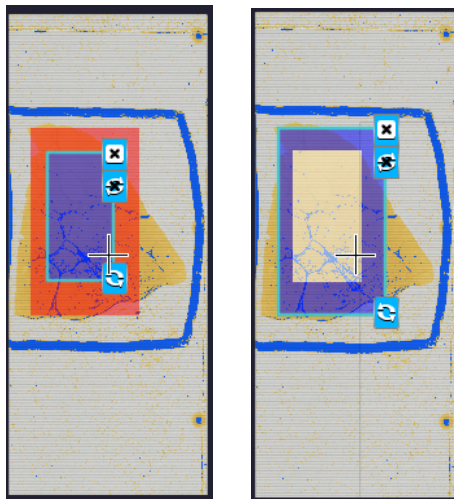





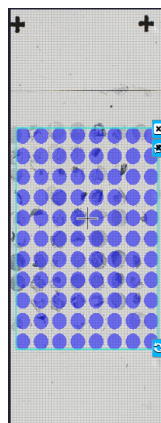



Figure 27 – Edited negative and positive selection masks.

- **Crop** : Crop the area of the selected area.
- **Place Circle** : You can select the area to be scanned with the different tools on the **Preview toolbar**.
- **Rectangle tool** : Draw rectangle shaped area.
- **Ellipse tool** : Draw ellipse selection.
- **Polygon tool** : Area selection by defining a polygon shape. Finish area selection by double-clicking with the mouse at or near the starting point.
- **TMA tool** : TMA tool is used for selecting TMA spots on TMA slides. You can set the selection settings on the following four tabs:



- **TMA Grid Setting** : This function is enabled only if a TMA grid has already been placed on the preview image. Set grid parameters (row and column numbers) and spot shape (round or rectangle).

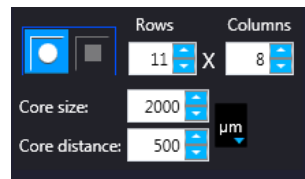



Figure 28 – TMA tool: Grid selector

Delete TMA grid by clicking the **X** at the top right corner, and rotate grid by clicking the icon at the bottom right corner. Enter the number of rows and columns in the **Rows** and **Columns** fields or select the appropriate values with the arrows.

Enter the distance between two spots on the X and the Y axis in μm in the **Core distance** fields or select the appropriate values with the arrows. Enter the average diameter of the spots in the **Core size** field or select the appropriate value with the arrows.

- **Clear scanmap** : The entire scanmap area will be cleared and reset to default.
- **Use selection box restriction** : The preview image shows the area that will be digitized with a red and/or an orange mask. If the **Use selection box** is enabled, and the crop function is selected, a black frame displayed in the image, and only the area inside the box is scanned. It is useful if you only want to scan the area that is equivalent with the size of the coverslip, so external specks will not be scanned.

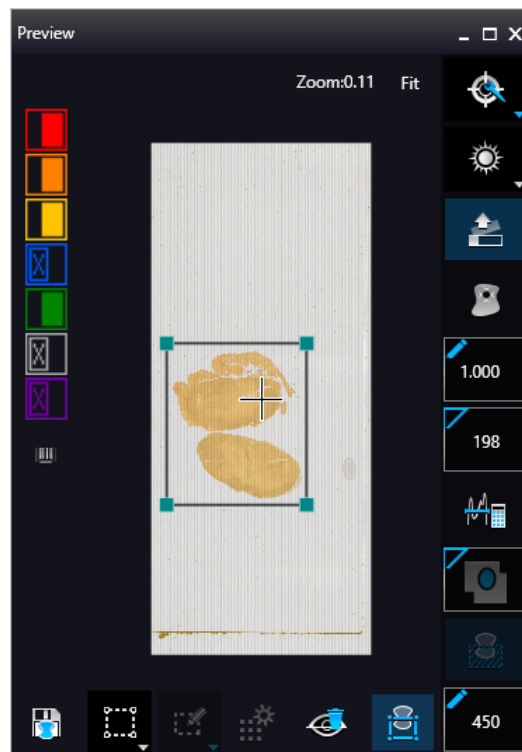
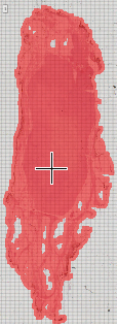



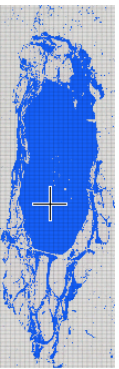

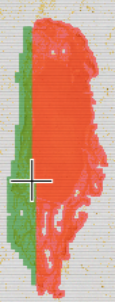





Figure 29 – Preview image

The following colors are used in the preview image to demonstrate digitization and selection settings:



Figure 30 – Colors in preview image and Label area switching button



	 <i>Areas that will be scanned</i>
	 <i>Detected sample areas that will be scanned</i>
	 <i>Detected sample areas that will not be scanned</i>
	 <i>Marker</i>
	<p>If Scan area inside the marker is selected in the Preview panel, the preview camera detects the marker pen. The inside areas appear in red color and will be digitized.</p>
	 <i>Areas scanned in</i>
	<p>This color is only displayed during scanning.</p>
	 <i>Hide all layers</i>
	<p>All the layers will be hidden / existing but not visible.</p>
	 <i>Separate scanning</i>
	<p>Discrete sample areas will be scanned separately as individual slides. If there are two samples on a slide, two separate virtual slides will be created.</p>

Click the  button to display barcode label area. To rotate the label area by 180°, click .



Figure 31 – Barcode label area window

5.1.2.2 Focus Indicator

Click  to activate the **Focus indicator** function. Search for the sharpest focus on the current field of view automatically by clicking  - **Auto focus** button.

To define focus limits, select **Limit the range**. Set the upper and lower limits by selecting the desired value in the selection boxes. By using **Set +-Range**, the **Lower limit** value is set to -32 of the current focus value and the **Upper limit** value is set to +32 of the current focus value. This is useful if **Auto Focus** does not find the focus on the specimen, but on the coverslip. Also, this makes the focusing sequence faster.

For manual focusing define the manual focus step size by adjusting the **Step size** slider and use the two arrow buttons to focus manually. This is useful when you are interested in an area that remained blurry with **Auto Focus** (for example, the specimen is thicker in that area). This does not influence the way slides are digitized in Auto focus mode.

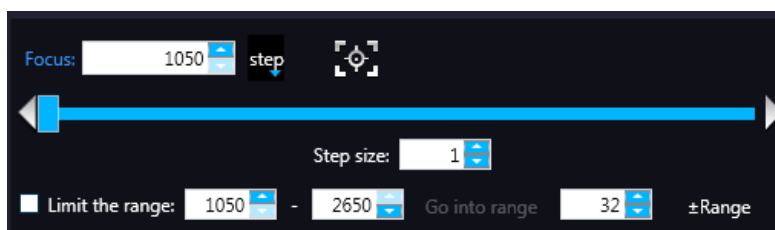



Figure 32 – Focus indicator panel

5.1.2.3 Exposure Indicator

Activate Exposure indicator function by clicking . Click  to calculate exposure time for the actual Live image. In Brightfield mode there is no option for manually setting the values. Exposure time can be displayed in microsecond, millisecond, and also in second.

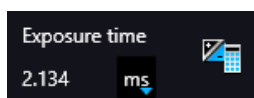



Figure 33 – Window of Exposure Indicator in Brightfield scan mode

Image Intensity

Click  to open Image intensity settings window. An **image** is defined as a two-dimensional function $f(x, y)$ the amplitude of at any pair of coordinates (x, y) is called the **intensity** or gray level of the **image** at that point. The pixel intensity at the coordinate pointing at with the cursor is displayed in the Image Intensity window.

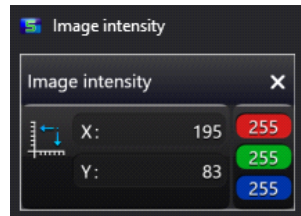



Figure 34 – Window of Image Intensity

5.1.2.4 Stage positioning

Click  to activate **Stage Positioning Tool** to navigate on the slide, so to perform microscope movements on the Live image with this control function. The number at the center of the controller defines the step size by which the stage is moved. Value can be entered by hand or with the slider.

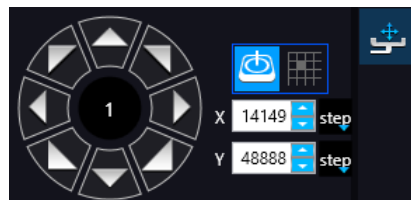

Figure 35 – Stage positioning tool

This tool offers easy and punctual slide navigation in distinctive steps. Set step size (FoV) – **1**, $\frac{1}{2}$, or $\frac{1}{4}$ to determine the size of movement in proportion of one FOV. Click an arrow to move to the required direction with the set step size.

5.1.2.5 Quick preview functions

Use **Ctrl+mouse wheel** to zoom in or out to the preview area or the Live image.

A quick preview function tool pops up by right-clicking to the preview area. It allows a quick access to main preview-related functions:

- Drag
- Draw
- Erase
- Retake preview
- Settings
 - Toggle deletion always on top
 - Reset zoom
 - Window auto-size
 - Clean scanmap

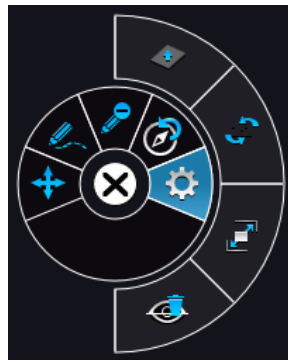

Figure 36 – Quick toolbar

5.1.3 Quick microscope functions

A quick microscope functions tool can be displayed upon right-clicking on the background of the main window (outside the preview window). It includes quick-access-buttons to main functions:



Figure 37 – Quick toolset for microscope

- **Focus**

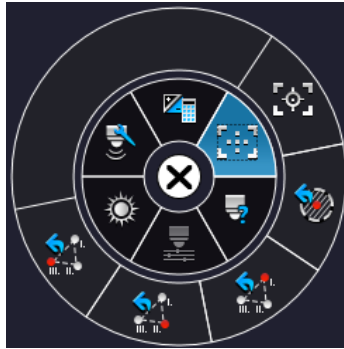

Figure 38 – Focus

- Autofocus
- Set coarse focus point
- Set interpolated focus point 1
- Set interpolated focus point 2
- Set interpolated focus point 3

- **Live tools**



- Fast mode
- Screenshot
- Magnifier
- Ruler
- Image processor plugins

- Add scanmap
- **Auto exposure**



5.2 Fluorescence Microscope Mode

Fluorescence Microscope View consist of three different sections:

- **Profile Settings panel:** Profile settings containing parameters used for scanning.
- **Microscope Control Panel:** Live microscope movement functions
- **Main functions:** Located at below the window header, these functions are identical in both modes.

5.2.1 Profile Settings panel

Set Parameters to auto



Every parameter is set automatically during scanning.

Filter Settings



Compact table view of microscope filters used for Fluorescence scanning.

Legend of the table:

- **A:** Actually used filter
- **Use:** Filters used for viewing Live image and for scanning.
- **Auto Exp:** When activated, the exposure time of the selected filter is calculated automatically during scanning.
- **Exp. Time:** If **Auto Exp** is inactive, exposure time of each filter can be defined manually. Values such as **Calc Exposure time** in Microscope Control panel and those that are specified manually are loaded in these fields. Value units can be the following: microsec, millisec, sec.
- **Exc %:** The given value specifies the excitation intensity in percentage of the illumination unit.
- **DG (Digital Gain):** This is camera-dependent, with Point Grey Grasshopper 3 the index value ranges from 0 to 4, and with pco.edge 4.2 from 0 to 6. Give **Index** value by entering it in the box or by selecting the value with the arrow buttons. If you raise the **Index** value, the exposure time is halved by every step, and the image becomes noisier. To move between the filters, click **Previous Filter** or **Next Filter**.
- **TW % :** You can set the **Exposure time weight (%)** here (displayed under **TW** in the **Filter Selection** frame).
- **F :** Focus channel under the scanning
- **S :** The selected channel will be the stitching channel under the scanning.

- **E** : Multilayer option: Select Extended focus or Z-stack scanning for the required channels in accordance with the scanning mode set in the profile.

	A	Use	AutoExp	Exp.Time	μs	Exc%	DG	x	TW%	F	S	E
DAPI_Q	<input checked="" type="radio"/>	<input checked="" type="checkbox"/>	<input type="checkbox"/>	20000		100	0		100	<input checked="" type="radio"/>	<input checked="" type="radio"/>	<input type="checkbox"/>
FITC_Q	<input type="radio"/>	<input type="checkbox"/>	<input type="checkbox"/>	20000		100	0		100	<input type="radio"/>	<input type="radio"/>	<input type="checkbox"/>
TRITC_Q	<input type="radio"/>	<input type="checkbox"/>	<input type="checkbox"/>	20000		100	0		100	<input type="radio"/>	<input type="radio"/>	<input type="checkbox"/>
Cy5_Q	<input type="radio"/>	<input type="checkbox"/>	<input type="checkbox"/>	20000		100	0		100	<input type="radio"/>	<input type="radio"/>	<input type="checkbox"/>
DAPI zero	<input type="radio"/>	<input type="checkbox"/>	<input type="checkbox"/>	20000		100	0		100	<input type="radio"/>	<input type="radio"/>	<input type="checkbox"/>
SPGreen SB	<input type="radio"/>	<input type="checkbox"/>	<input checked="" type="checkbox"/>	Auto		Max 100	0		100	<input type="radio"/>	<input type="radio"/>	<input type="checkbox"/>
SpOrange	<input type="radio"/>	<input type="checkbox"/>	<input checked="" type="checkbox"/>	Auto		Max 100	0		100	<input type="radio"/>	<input type="radio"/>	<input type="checkbox"/>
Cy5	<input type="radio"/>	<input type="checkbox"/>	<input checked="" type="checkbox"/>	Auto		Max 100	0		100	<input type="radio"/>	<input type="radio"/>	<input type="checkbox"/>

Figure 39 – Filter table

Objective Settings

This field displays the objective used for scanning. Objective type: 20x; 40x

Focus

Focus settings for the scanning. Focus modes can be the following:

- **Coarse focus:** By selecting the **Use manual focus** box, you can preset the coarse focus value. By activating the **Coarse focus** function, the lower limit value is set to -64, and the upper limit value is set to +64 of the current focus value.



Note:

Before entering coarse focus value, turn live image on and set a suitable focus position.

You can accept the current Z-value by clicking **Assign Current**.

- **Interpolated focus:** If you select the **Interpolated focus** option, the coarse focus level is calculated from three different focus points of the specimen. Carry out a manual focusing sequence in the preview image on those three points. Set the correct focus value of the desired preview position by clicking **Set** in the table of interpolated focus. If you want to go back to any of the previously set focus points, click the appropriate **Goto** button.

To delete the stored values, click the other proper focus point or turn off the function. The software calculates a coarse focus level from the three values determined this way as a basis for the fine focusing routine. You can only define the start parameter here. This will, however,

speed up the focusing process. If you deselect the **Use fine focus** checkbox, the software immediately starts scanning on the basis of the interpolated values, without pre-fine-focusing.

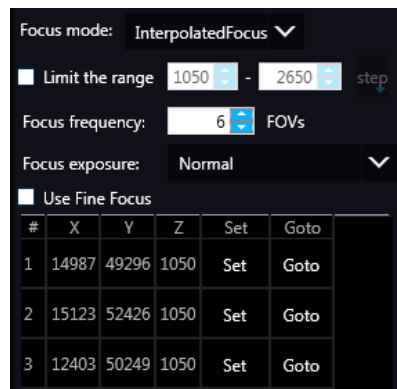

- **Auto focus:** Focus value is set automatically to match sample characteristics.
- **Limit the range:** You can define focus limits by selecting **Limit the range** for focusing. You can set the upper and lower limits by selecting the desired value in the selection boxes. This is useful if focusing was not targeted on the specimen, but on a spot on the coverslip.
- **Focus frequency :** This value determines how many field of views will pass before the sample is refocused. This value should be selected depending on the unevenness and size of the specimen.
- **Focus Exposure:** The exposure time during focusing, it can have three states:
 - Short
 - Normal
 - Long

Sample detection

The Sample detection panel offers options for setting threshold and the selection of scannable areas.

- **Source**
 - **Brightfield preview** – a normal type of illumination in the microscope for scanning the slide. This option is recommended when scanning in Brightfield mode.
 - **Fluorescent PreScan** - creates a fast FL preview image that is displayed in the Profile Wizard window. Scanning process takes a couple of minutes only, and it cannot be interrupted.
 - **Fluorescent PreScan (HR)** - creates a High-Resolution fast FL preview image of every FOV within the selected area (in single layer DAPI, with an illumination time of 20ms) that is displayed in the Profile Wizard window. Scanning process takes a couple of minutes only, and cannot be interrupted.

- **Fluorescent PreScan (+HR)** - creates a High-Resolution fast FL preview image of every FOV within the selected area (in single layer DAPI, with an illumination time of 20ms) that is displayed in the Profile Wizard window. Scanning process is initiated with a simple PreScan, the located sample with auto threshold is selected, and finally, an HR PreScan is launched.
- **Thresholding**

The manually set threshold value is applied during scanning. The preview of the loaded slide is displayed in the Preview window. The set value has effect on the preview image. If threshold value is modified in the Microscope Controller preview window, that value is automatically applied in the profile in the Profile Settings panel.

- **Specimen threshold**
- **Manually set value:** This sets the sensitivity of the specimen detection. To set the desired threshold value manually, change the setting in the **Specimen threshold level** selection box in the range of 0-255. The default value is 212. Smaller values result in a more sensitive scanning, meaning that more areas will be digitized, however, this may also include specks or other imperfections of the slide. Greater values result in a less sensitive scanning, but it is possible that some of the smaller specimen areas will not be digitized.
- **Auto Threshold**

By clicking  the specimen will automatically be detected in the preview image.



Caution!

Make sure that the detection result is acceptable for you. Otherwise, set the threshold value manually or append missing areas with the help of appropriate functions in the **Preview** window.

- **Use marker with threshold**

If the specimen cannot be identified as required for digitization, (for example, weak contrast), it can help to encircle completely the specimen with a black marker pen. You have to draw a full circle with the pen to enable the detection. Marker pen detection will make specimen detection easier by limiting the scanned area. If this option is selected, only the area encircled with a marker pen will be scanned. You can define the threshold level by changing the threshold value in the **Use marker with threshold** selection box in the range of 0-255. This sets the sensitivity of the specimen detection inside the marker area. To set the desired threshold value manually, change the setting in the **Specimen threshold** selection box in the range of 0-255. The default value is 105.

- **Everything within marker**

To scan everything within the marked area, check the **Everything within marker** selection box.

Alternatively, click  in the preview window to activate this function.

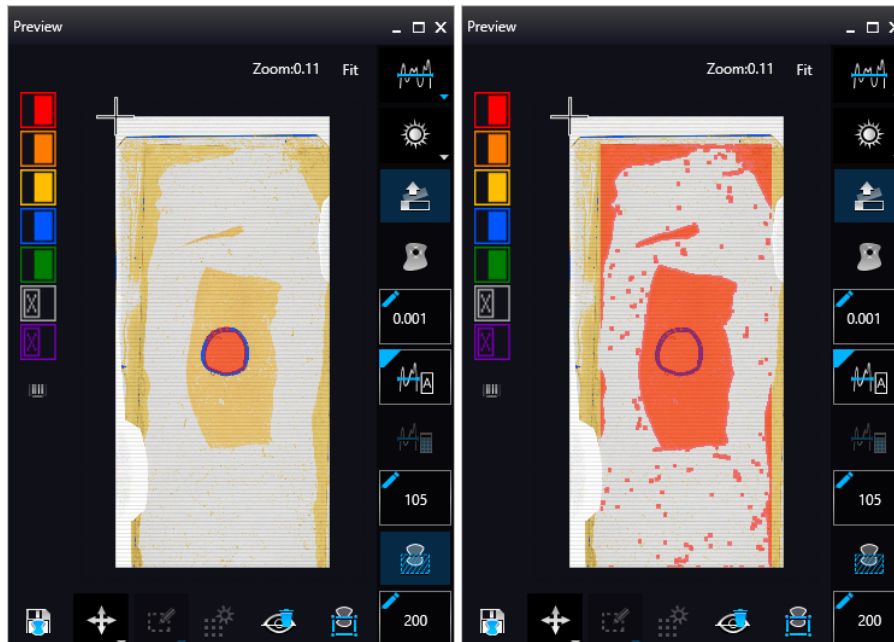

Figure 40 – Scan everything within the marked area (selected / not selected)

- **Threshold enhancement**

- **Remove coverslip** – If selected, the edges of the coverslip are not detected as specimen to be scanned. Depending on the threshold, it is possible that the edges of the coverslip are detected as areas to be digitized.

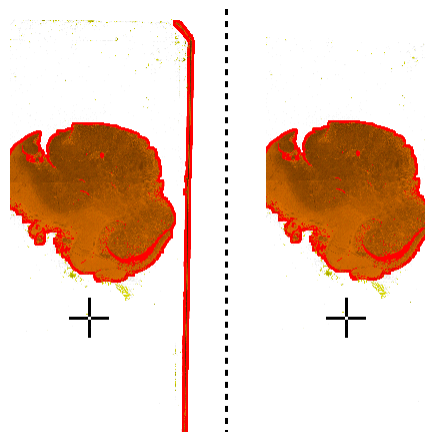

Figure 41 – Preview image with and without coverslip edge

**Caution!**

It requires lots of time (since it cannot find focus neither on the edges, nor on specks) to digitize coverslip edges. Select **Remove coverslip** function to eliminate those areas.

**Warning!**

Do **not** use **Remove coverslip** function on TMA slides! The layout of TMA slides may mislead the detecting algorithm.

- **Fill holes inside the scanmap** – If selected, the holes inside the specimen will also be scanned. Often these holes contain small sample objects that otherwise would not be scanned.
- **Remove specks** – If selected, the scanner does not digitize objects smaller than the predetermined size. This helps filtering specks and other uninteresting objects out. Set the maximum size of specks not to be digitized by adjusting the **Speck size** slider.
- **Dilate mask** – Adjust the slider to enlarge or decrease the scanned area. The edge is extended discretely by 100 µm each time.

Scanmap option

The previously saved scanmap can be loaded for use.

- **Use Threshold:** Preview settings set in Microscope Controller Panel / Preview window are applied to create a scanmap.
- **Loaded scanmap:** This function is useful if the slides contain areas of interest that cannot be detected by the preview camera. This function along with saving profiles helps to scan all slides with the most adequate settings.

To load a mask, click  first, then browse for the scanmap to be loaded.

- **Custom scanmap:** The scanmap drawn on the preview image is used for scanning.

- **Use selection box restriction**



If selected, only the area inside the box is scanned. It is useful if you only want to scan the area that is equivalent with the size of the coverslip, so external specks will not be scanned.

Multilayer mode

- **Single layer mode:** If none of the filters are selected in the Filters table for multilayer scanning, this mode is active and can be selected, and Multilayer mode turns inactive.
- **Extended focus:** By choosing the **Extended focus** option, the software selects the sharpest image from each focus level for each image field, and combines them into one single image. Therefore those parts that were blurry in auto/manual focus will also be sharp. This method guarantees the maximum depth of sharpness, however, it reduces digitization speed.
- **Z-stack scan mode:** Both for Extended focus and **Z-Stack** scanning methods, you can determine the desired number of focus levels with the **Focus levels** selection box. The current focus value is the starting point. If you set 5 for example, one current, two focus levels above and below FOVs are captured. Therefore, it is advised to choose an odd number for the focus levels. Separate layers are created and stored this way, and can be opened with Pannoramic Viewer. The Z-stack slide contains the extended focus layer.

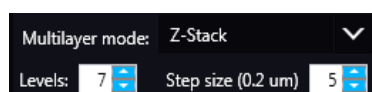

Focus step size determines the spacing between focus levels. One step is around 0.2 μm . Default settings are: **Number of focus levels: 7; Focus step size: 5.**

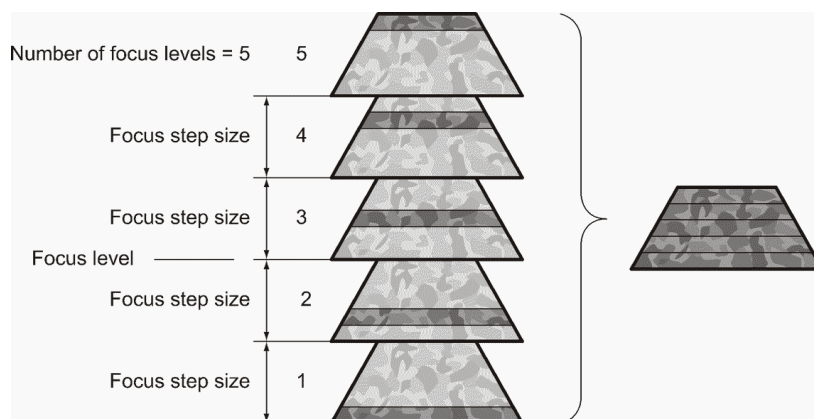

Figure 42 – Focus level and step size

Scan settings

- **Change filters after whole slide scanning**
To optimize speed, filter change should take place after the digitization of the slide with one channel.
- **Change filters at each field-of-view**
Filters should be changed for each field of view if very precise colocalization is required, but consider that this option is more time consuming.

**Note:**

Make sure to select the **Change filters at each field of view** option if using multi band filter for multi-channel digitization.

**Caution!**

If the specimen area is barely visible, it is possible that the software will analyze that area as an empty one.

- **Multiple shots**
- **Maximum exposure time** – A limit value can be set to determine that the exposure time cannot be longer than the time of focusing and calculation of exposure. This is necessary because the exposure time would be too long when taking image of an empty field of view. Default value is 2000 ms.

Image Correction settings

- **Use Flatfield correction** – If this function is active the scanned slide compensates itself with a special method (light intensity statistical data, not to modify the average intensity of the slide. Quantitative measurements can be made on the slide. The following three options can be selected from the drop-down list:
 - **Intensity statistics** – legacy compensation algorithm
 - **Reduce intensity** – pixel-level analyzation of the acquired image during which the background of the image is reduced based on the comparison of the image recorded by the camera and the compensation image.
 - **Intensity equalization** – pixel-level analyzation of the acquired image, a one-by-one type image compensation method is applied.
- **Extended focus** – Select the type of the extended focus algorithm used during scanning:
 - **Legacy** – uses original extended focus algorithm, it is recommended for wide-field fluorescence scanning.
 - **Maxima** – the final image is made up from all of the layers created, areas (pixel groups) with the highest intensity are combined together.
 - **AVG** – an average of the layers is used for the final image.
 - **Max-AVG** – the final image is made up from all of the layers created, areas (pixel groups) with higher intensity than the average are combined together.

Image settings



Choose one of the following predefined image formats (and a subsequent custom option) from the **Image Quality** drop-down list:

- Excellent (JPEG: 90)
- Good (JPEG: 80)
- Medium (JPEG: 60)
- Low (JPEG: 30)
- Custom... – If choosing this option, the Image compression setting is displayed on which you can select from different image formats. Accordingly, further adjustments can be made, except if PNG or BMP image format is selected.



Figure 43 – Image encoding window

- **Compression**
 - **BMP** – Lossless uncompressed image format, but larger files due to less effective compression. It is a raw data file.
 - **PNG** – Lossless compressed image format.
 - **JPG** – The quality can be set in the value box. Greater values result in better quality, but larger files. The default setting is 80%.
- **Bit depth:** 8-bit
- **Stitching:** Use Stitching function enables the seamless stitching of digital tiles.
- **Sharpening:** Select this option to improve the visual appearance of digital slides.

5.2.2 Microscope Control Panel

5.2.2.1 Preview window

Click  to open the Preview panel that offers options for threshold setting and selection of the area to be scanned.

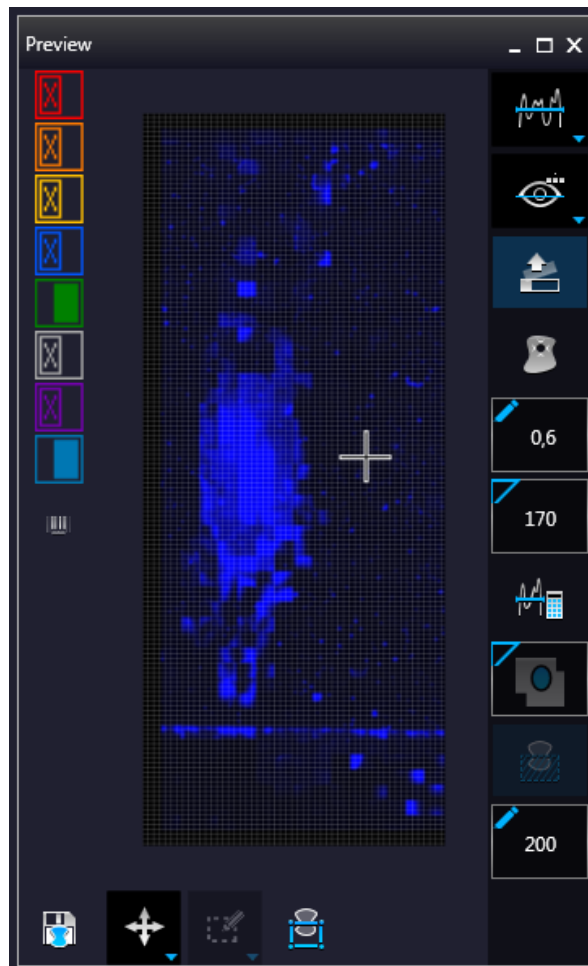





Figure 44 – Pre-scan preview image





Threshold options

This section is located at right side of the preview window. **Scanmap Source** is designed to set which type of scanmap is used on the preview image. This scanmap is displayed automatically in the **Profile Scanmap Source** setting. Selectable scanmap types are the following:

- Use threshold 
- Load previously saved scanmap from file 
- Custom scan map 

Preview Types

In FL Microscope mode the following additional preview modes are available:

- **Brightfield preview**  – a normal type of illumination for scanning. This option is recommended when scanning in Brightfield mode.
- **Pre-scan**  – creates a fast FL preview image that is displayed in the Profile Wizard window. Scanning process takes a couple of minutes only, and it cannot be interrupted.
- **Pre-scan high-resolution**  – creates a High-Resolution fast FL preview image of every FOV within the selected area (in single layer DAPI, with an illumination time of 20ms) that is displayed in the Profile Wizard window. Scanning process takes a couple of minutes only, and cannot be interrupted.
- **Pre-scan + high-resolution**  – creates a High-Resolution fast FL preview image of every FOV within the selected area (in single layer DAPI, with an illumination time of 20ms) that is displayed in the Profile Wizard window. Scanning process is initiated with a simple PreScan, the located sample with auto threshold is selected, and finally, an HR PreScan is launched.

Remove coverslip

If selected, the edges of the coverslip are not detected as specimen to be scanned. Depending on the threshold level, it is possible that the edges of the coverslip are detected as areas to be digitized.

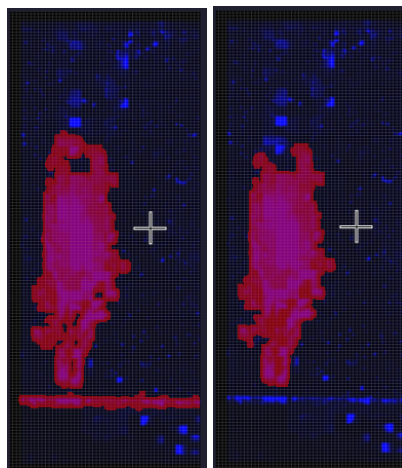

Figure 45 – Preview image with and without coverslip edge

**Caution!**

It requires lots of time (since it cannot find focus neither on the edges, nor on specks) to digitize coverslip edges. Select **Remove coverslip** function to eliminate those areas.

**Warning!**

Do **not** use **Remove coverslip** function on TMA slides! The layout of TMA slides may mislead the detecting algorithm.

Fill holes in scanmap

If selected, the holes inside the specimen will also be scanned. Often these holes contain small sample objects that otherwise would not be scanned.

Remove specks

If selected, the scanner does not digitize objects smaller than the predetermined size. This helps filtering specks and other uninteresting objects out.

Set the maximum volume of specks manually in the setting window

**Threshold**

- **Auto threshold**



Select this option to automatically detect the specimen in the preview image.

**Caution!**

Make sure that the detection result is acceptable for you. Otherwise set the threshold value manually.

- **Manual threshold** 

Set value manually or calculate value by using the **Calculate Threshold**  function (can be activated only when manual thresholding is selected). This sets the sensitivity of the specimen detection. To set the desired threshold value manually, change the setting in the **Specimen threshold level** selection box in the range of 0-255. The default value is 212. Smaller values result in a more sensitive scanning, meaning that more areas will be digitized, however, this may also include specks or other imperfections of the slide. Greater values result in a less sensitive scanning, but it is possible that some of the smaller specimen areas will not be digitized.

Use marker with threshold 

If the specimen cannot be identified as required for digitization, (for example, weak contrast), it can help to encircle completely the specimen with a black marker pen. You have to draw a full circle with the pen to enable the detection. Marker pen detection will make specimen detection easier by limiting the scanned area.

- **Manual setting of Use marker with threshold** 

If this option is selected, only the area encircled with a marker pen will be scanned. You can define the threshold level by changing the threshold value in the **Marker threshold level** selection box in the range of 0-255. This sets the sensitivity of the specimen detection inside the marker area. To set the desired threshold value manually, change the setting in the **Threshold** selection box in the range of 0-255. The default value is 212.

Everything within marker 

Available only if **Use marker with threshold** function is activated. To scan everything within the marked area, check the **Scan everything within marker** selection box.

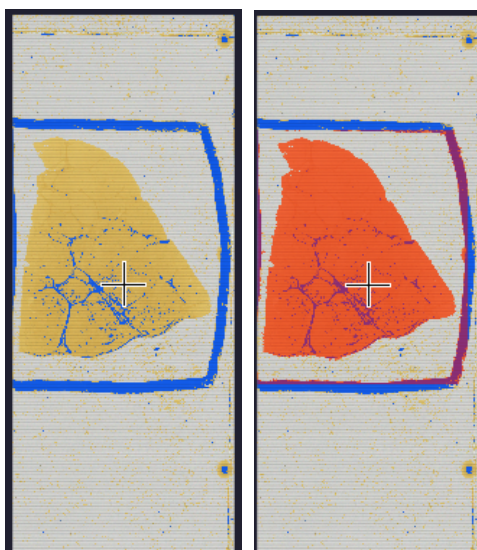



Figure 46 – Scan everything within the marker selected / not selected





Dilate mask

Adjust the slider to enlarge or decrease the scanned area. To switch to manual mode click the top left corner of the button and the required value can be entered in the box .

Preview Toolbar

This section is located at the bottom of the preview image.



- **Save scanmap**  – Click this icon to save the currently selected areas to scanmap.
- **Position**  – To position the specimen holder that holds the current slide, click **Position sample** and then click on the area of interest on the preview image. This will define the Live image that you can access from the **Live view** .
- **Union**  – Add the selected areas to the preview. Mark area for scanning based on the shape selected in the Preview Toolbar. This area will not be scanned.
- **Erase**  – Delete selected areas from the preview image. Deselection is made based on the selected shape from the Preview Toolbar. This area will not be scanned.

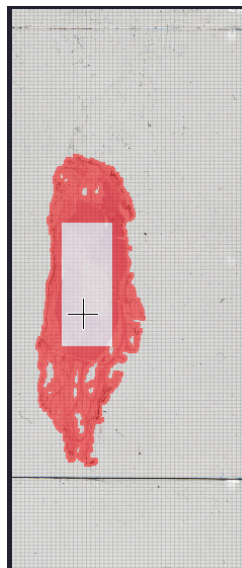



Figure 47 – Not scanned selection

- **Edit** : The size of selected area (positive or negative) can be modified at the borderlines or corners.

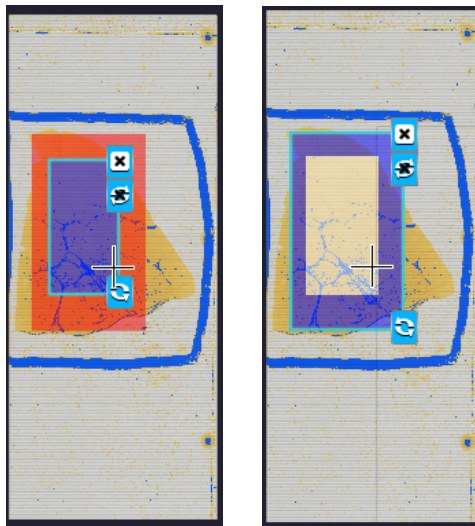





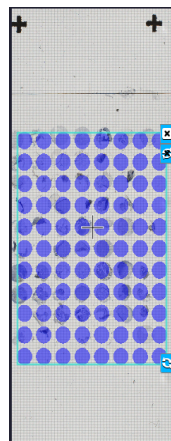



Figure 48 – Edited negative and positive selection masks

- **Crop** : Crop the area of the selected area.
- **Place Circle** : You can select the area to be scanned with the different tools on the **Preview toolbar**.
- **Rectangle tool** : Draw rectangle shaped area.
- **Ellipse tool** : Draw ellipse selection.
- **Polygon tool** : Area selection by defining a polygon shape. Finish area selection by double-clicking with the mouse at or near the starting point.
- **TMA tool** : TMA tool is used for selecting TMA spots on TMA slides. You can set the selection settings on the following four tabs:



- **TMA Grid Setting** : This function is enabled only if a TMA grid has already been placed on the preview image. Set grid parameters (row and column numbers) and spot shape (round or rectangle).

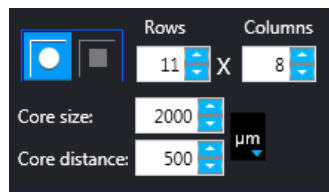

Figure 49 – TMA tool: Grid selector

Delete TMA grid by clicking the **X** at the top right corner, and rotate grid by clicking the icon at the bottom right corner. Enter the number of rows and columns in the **Rows** and **Columns** fields or select the appropriate values with the arrows.

Enter the distance between two spots on the X and the Y axis in μm in the **Core distance** fields or select the appropriate values with the arrows. Enter the average diameter of the spots in the **Core size** field or select the appropriate value with the arrows.

- **Clear scanmap** 

The entire scanmap area will be cleared and reset to default.

- **Use selection box restriction** 

If selected, only the area inside the box is scanned. It is useful if you only want to scan the area that is equivalent with the size of the coverslip, so external specks will not be scanned. The preview image shows the area that will be digitized with a red and/or an orange mask. If the **Use selection box** is enabled, there is a black frame displayed in the image.

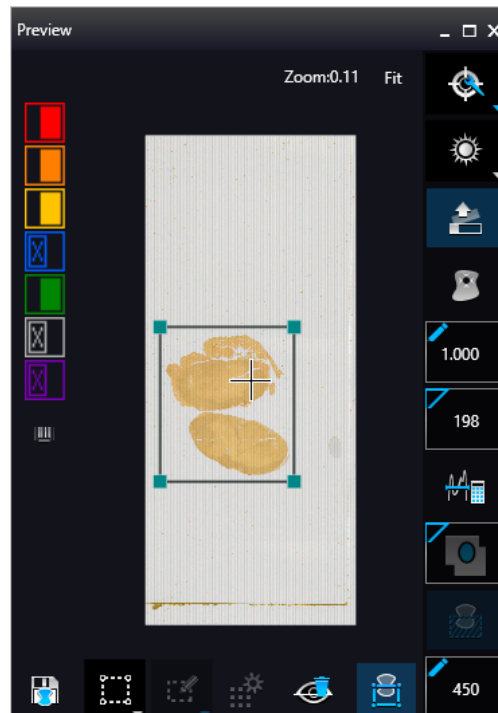

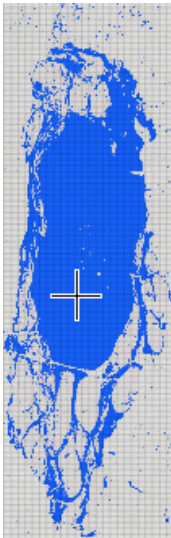

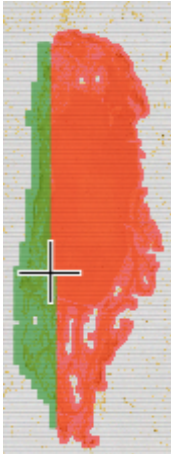



Figure 50 – Use selection box

The following colors are used in the preview image to demonstrate digitization and selection settings:



Figure 51 – Colors in preview image and Label area switching button

	 <i>Areas that will be scanned</i> These areas are digitized on the basis of user settings (for example, Fill holes in scan area) and not detected by the selected threshold value.
	 <i>Detected sample areas that will be scanned</i> These areas are digitized. They are detected on the basis of the selected threshold value.
	 <i>Detected sample areas that will not be scanned</i> These areas are not digitized on the basis of their position (for example, they are outside the selection box). They are detected by the selected threshold value.

	 <p><i>Marker</i></p>
	<p>If Scan area inside the marker is selected in the Preview panel, the preview camera detects the marker pen. The inside areas appear in red color and will be digitized.</p>
	 <p><i>Areas scanned in</i></p>
	<p>This color is only displayed during scanning.</p>
	 <p><i>Hide all layers</i></p>
	 <p><i>Separate scanning</i></p>
	<p>Discrete sample areas will be scanned separately as individual slides. If there are two samples on a slide, two separate virtual slides will be created.</p>
	 <p><i>Show pre-scans pseudo-colored</i></p>



Click the  button to display barcode label area. To rotate the label area by 180°, click .



Figure 52 – Barcode label area window

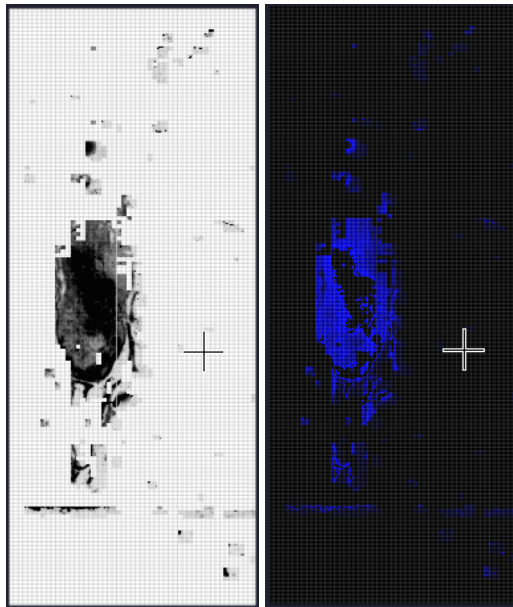



Figure 53 – Pseudo-colored pre-scan image

5.2.2.2 Focus Indicator

Click  to activate the **Focus indicator** function. Search for the sharpest focus on the current field of view automatically by clicking  - **Auto focus** button.

To define focus limits, select **Limit the range**. Set the upper and lower limits by selecting the desired value in the selection boxes. By using **Set +-Range**, the **Lower limit** value is set to -32 of the current focus value and the **Upper limit** value is set to +32 of the current focus value. This is useful if **Auto Focus** does not find the focus on the specimen, but on the coverslip. Also, this makes the focusing sequence faster.

For manual focusing define the manual focus step size by adjusting the **Step size** slider and use the two arrow buttons to focus manually. This is useful when you are interested in an area that remained blurry with **Auto Focus** (for example, the specimen is thicker in that area). This does not influence the way slides are digitized in Auto focus mode.

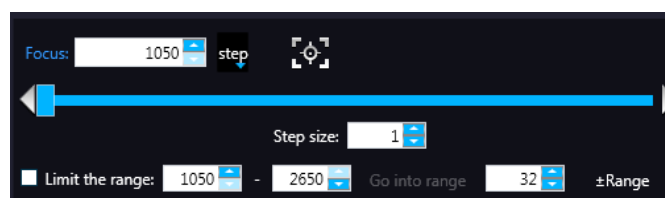



Figure 54 – Focus indicator panel

5.2.2.3 Exposure Indicator

Exposure time for the live image can be calculated by using the **Calculated Exposure** function . It is available to switch between microsecond, millisecond, and second units for the reading of exposure time.

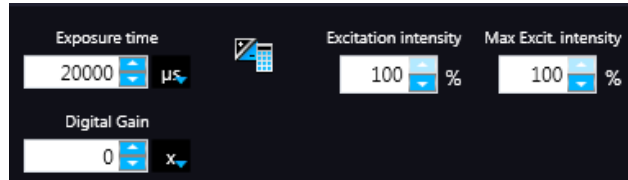

Figure 55 – Window of Exposure Indicator in Fluorescence scan mode

Select the types of filters you want to use during scanning. You can select the filter types and the number of channels to be used. The values in the **EXC** column define the excitation of the Lumencor illumination, in **TW** define exposure time weight, and in the **DG** the amount of digital gain is displayed. It is also available for you to enable Extended Focus (**EF**) and/or Z-stack (**ZS**) functions in this field.

Exposure Settings

You can set the **Exposure time weight (%)** here (displayed under **TW** in the **Channel Settings** frame). Set Lumencor excitation intensity at the **Excitation intensity (%)** field. The defined value will be used as maximum when applying Auto Exposition time if you activate the **Max. excit. intensity** option.



Caution!

To prevent over-exposure, the **Excitation intensity (%)** value can be modified by the software when calculating **Auto Exposure** time.

Image Intensity

Click  to open Image intensity panel. An **image** is defined as a two-dimensional function $f(x, y)$ the amplitude of at any pair of coordinates (x, y) is called the **intensity** or gray level of the **image** at that point. The pixel intensity at the coordinate pointing at with the cursor is displayed in the Image Intensity window.

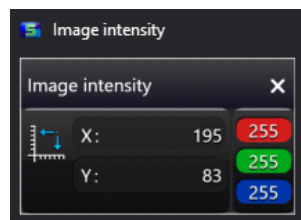



Figure 56 – Window of Image Intensity

5.2.2.4 Stage positioning

After clicking  you can perform microscope movements on the Live image with this control function. The number at the center of the controller defines the step size by which the stage is moved. Value can be entered by hand or with the slider.

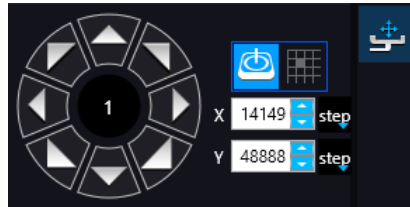

Figure 57 – Stage positioning panel

5.2.3 Hidden functions

Use **Ctrl + mouse wheel** to zoom in or out to the preview area or the Live image.



Figure 58 – Settings of preview quick toolbar

A **Quick Toolbar** pops up by right clicking any of the control menu items. It allows a quick access to main functions, and for FL these are the following:

- Drag
- Draw
- Erase
- Retake preview

- Settings
 - Toggle delation always on top
 - Reset Zoom
 - Window auto-size
 - Clear Scanmap

5.2.4 Quick Microscope functions

A quick microscope functions tool can be displayed upon right-clicking on the background of the main window (outside the preview window). It includes quick-access-buttons to main functions:



Figure 59 – Quick toolset for microscope

- Focus



Figure 60 – Focus

- Autofocus
- Set coarse focus point
- Set interpolated focus point 1
- Set interpolated focus point 2
- Set interpolated focus point 3

- **Objective type**

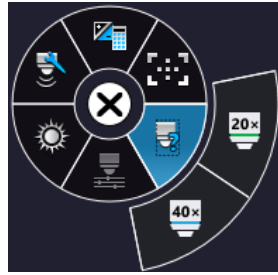

Figure 61 – Objective type

- 20x
- 40x

- **Filters**

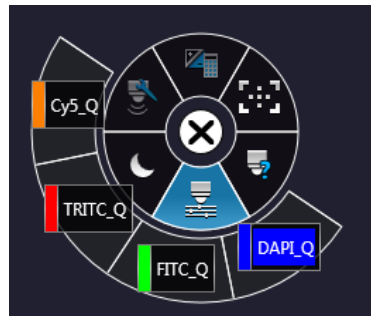

Figure 62 – Filters

- **Microscope mode**

- Brightfield
- Fluorescence



Figure 63 – Microscope mode

- **Live tools**
 - Fast mode
 - Screenshot
 - Magnifier
 - Ruler
 - Image processor plugins
 - Use pseudo-color
 - Add scanmap



Figure 64 – Live tools

- **Auto-exposure**



Figure 65 – Auto-exposure

5.2.5 Bottom menu bar of the main window

Profile History

This function can be activated by clicking  in **Preferences**. During setting scanning profile all of the previously used parameter will be saved automatically.

Each modification in the profile creates a so-called Milestone unit. These stage units are linked in a row displayed at the bottom left corner of the main window.

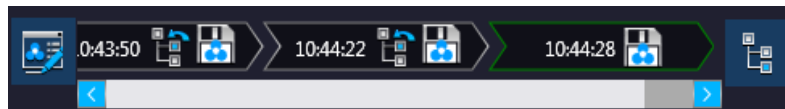

Figure 66 – Progress of the profile modification history

Once you are moving the mouse cursor over a unit all of the parameters will become visible in a pop-up window.

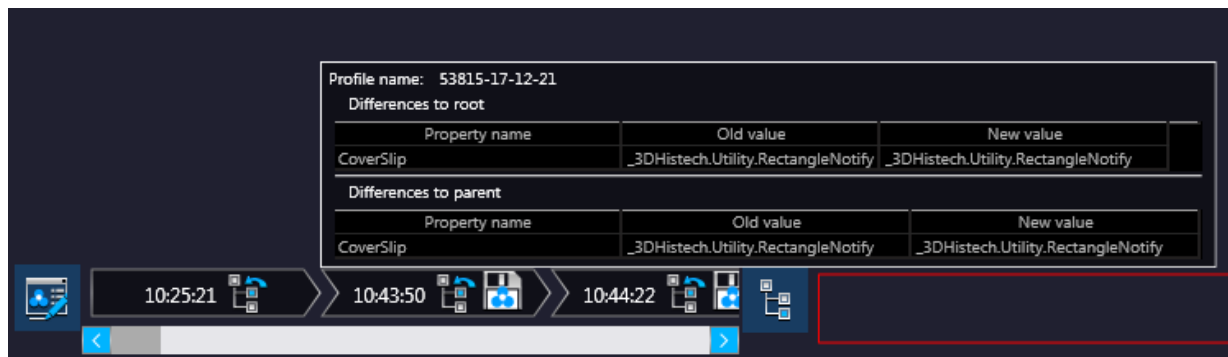





Figure 67 – Details of parameter modification

For the easier perspicuity, modifications can be observed in a pop-up window by clicking the  button in which both the original and the modified values are presented.

Click  to save parameters of the milestone unit into a new profile.

Click  to restore a modification stage (load parameters of a milestone unit) if needed.

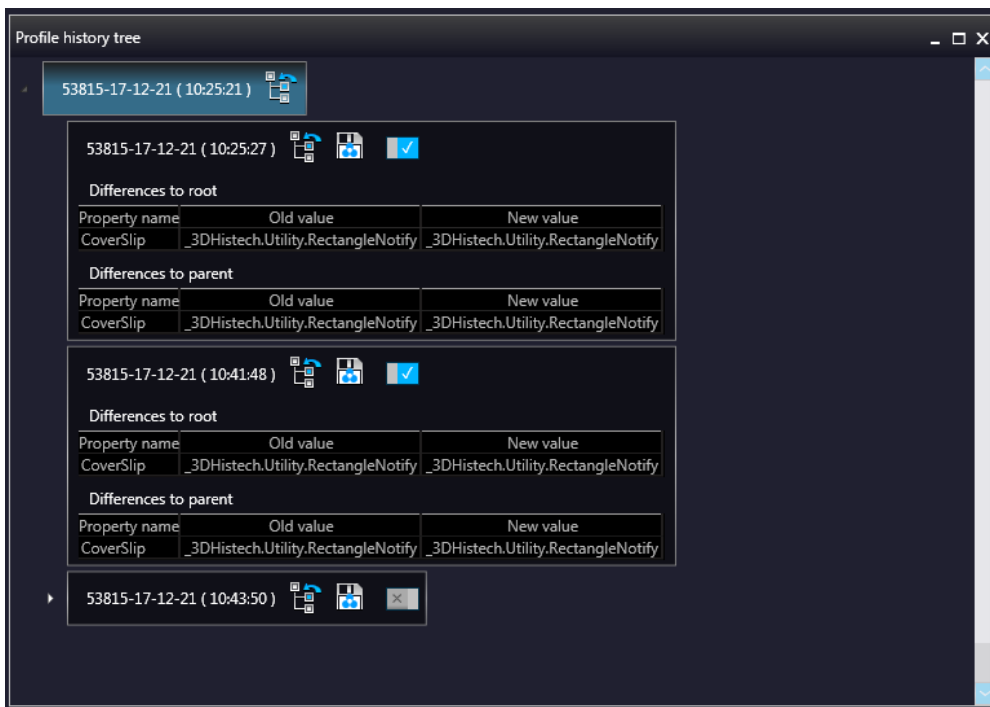
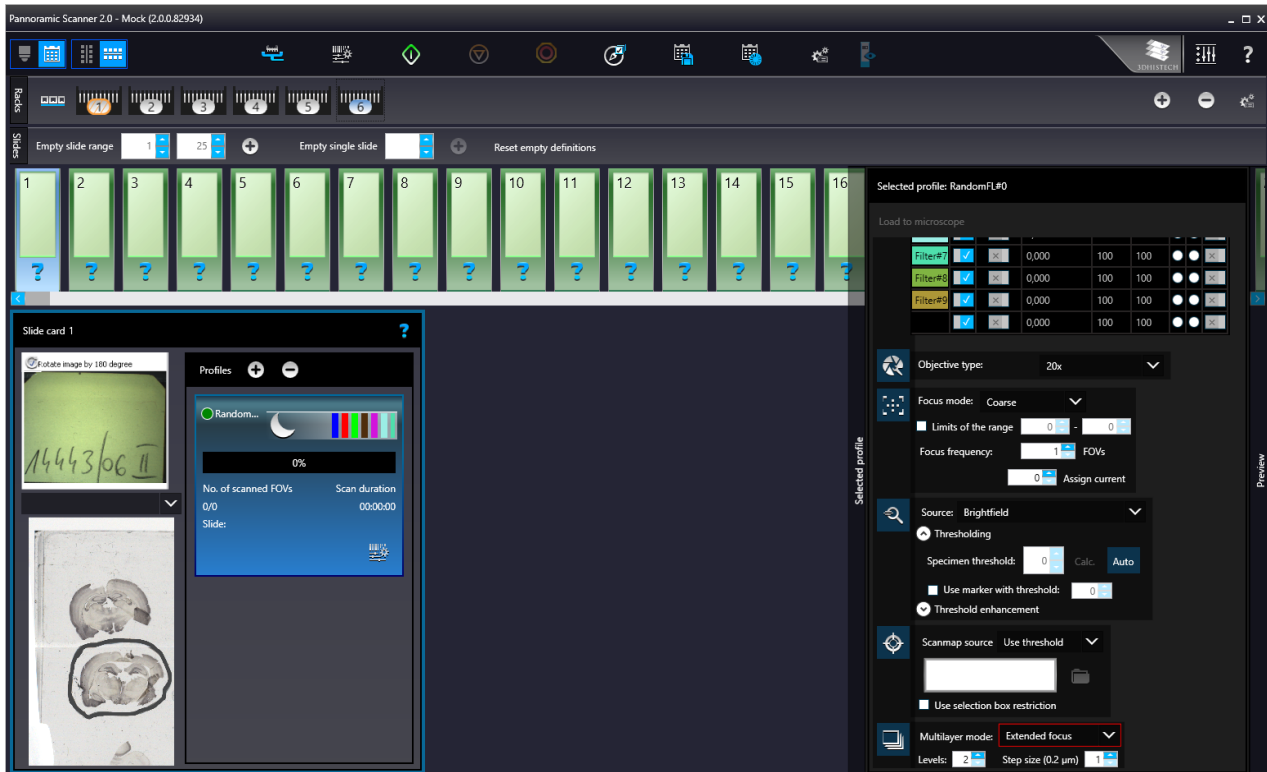

Figure 68 – Profile history tree

5.3 Planner mode

The whole scanning procedure can be planned in this mode. Assign profiles to slides, modify scanmaps without performing physical loading of slides. In Planner mode not only the scanning of the actually loaded magazine can be planned, but also profile assignment to slides of prepared virtual magazines is available to be performed. It is also possible to scan to different locations with each profile, and virtual slides can be created and stored in different folder or server.



Planner module offers you three window layout types for planning scans, located under the **Preferences / Planner Layout Selector** menu:

-  – Slide view with card
-  – Table
-  – Card collection

5.3.1 General functions at the main menu

 **Microscope/Planner selector**

 **Horizontal/Vertical selector** (Available in **Slide view with card** mode)

 **Stage Control** – Available after initialization, upon clicking the slide icon or entering slide position number at the right side, the slide can be loaded.

 **Scan to** – Available after loading procedure, unique settings can be defined even for each separate scanning.

 **Start scan** – Scanning of the actually loaded slide, or if the planner has been defined, the whole scanning process can be initiated.

 **Stop scan**

 **Stop actual process**

 **Take all previews** – Preview images of all the slides in the magazine are taken automatically. Select the required preview type from the following: Brightfield, Pre-scan, Pre-scan high-resolution, Pre-scan + high-resolution.

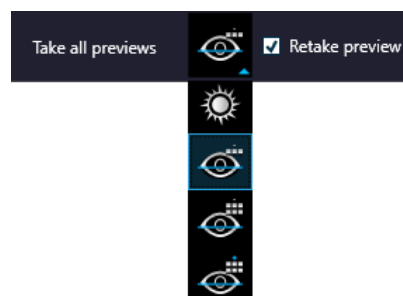





Figure 69 – Take all preview selector

 **Save planner** – A scanning plan containing all parameters and profile assignment will be saved.

 **Load planner** – The previously saved scanning plan can be loaded.

 **Planner menu** – The following profile-related tasks applicable for the planner can be performed:

- Add current profile to all racks
- Open profile for all racks
- Detach current profile from all racks
- Detach profiles from racks

- Clear planner

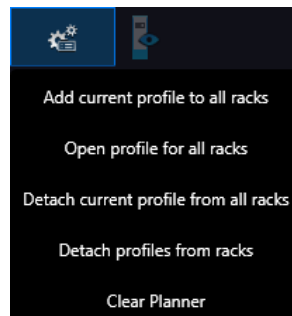

Figure 70 – Planner menu



Jump to scanned – Loads the planner view of the actual slide during scanning



Preferences



Help

5.3.2 General functions at the magazine menu



Rack view mode selector

Switch view by clicking this button. Click to add a virtual magazine to the planner, and to remove a magazine from the planner.



Rack menu includes the following global settings applicable to all magazines:

- Add current profile for all slides
- Open profile to all slides
- Detach current profile from all slides
- Detach profiles from slides

5.3.3 General functions at the slide menu

- Mark empty slide positions – Define range in the **Empty slide range** boxes to set multiple slide positions as empty. For single slides, enter / set slide position with the arrows in the **Empty single slide** box or right-click on a slide and select **Mark as empty**.
- Click **Reset empty definitions** to cancel slide selections as empty, or right-click the slide selected as empty and click **Reset**.

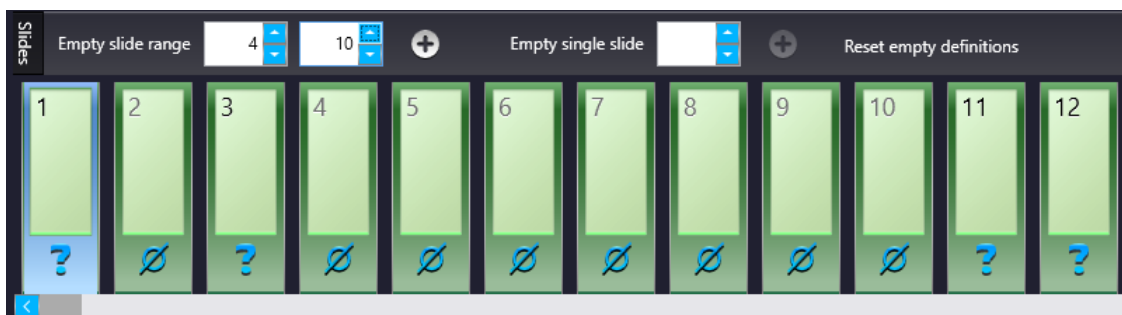



Figure 71 – General functions at the slide menu

5.3.4 Slide view with card

Select  from **Preferences / Appearance settings / Planner layout selector** to activate this view.

Depending on the actual view preference selected at , slide positions can have a horizontal or vertical layout. Slide preview and the list of the assigned profiles are displayed.

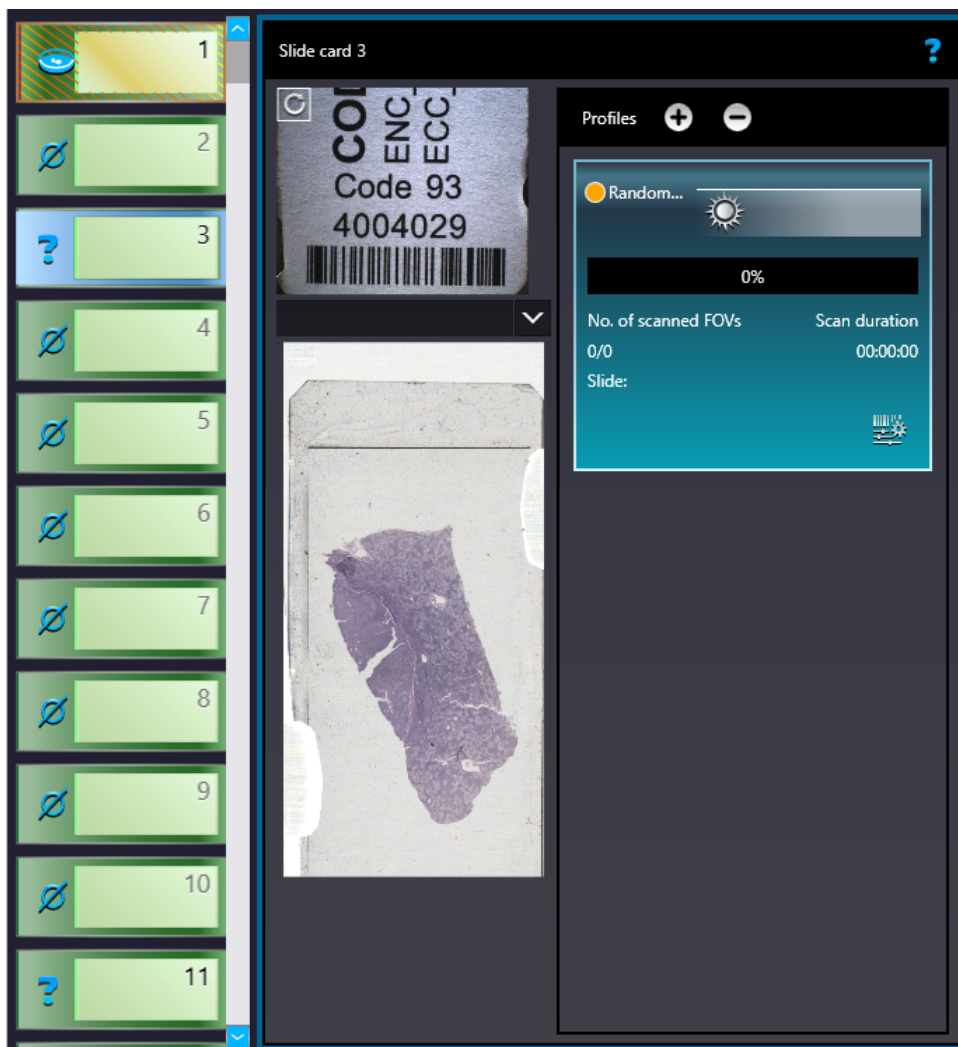

Figure 72 – Vertical slide view with card

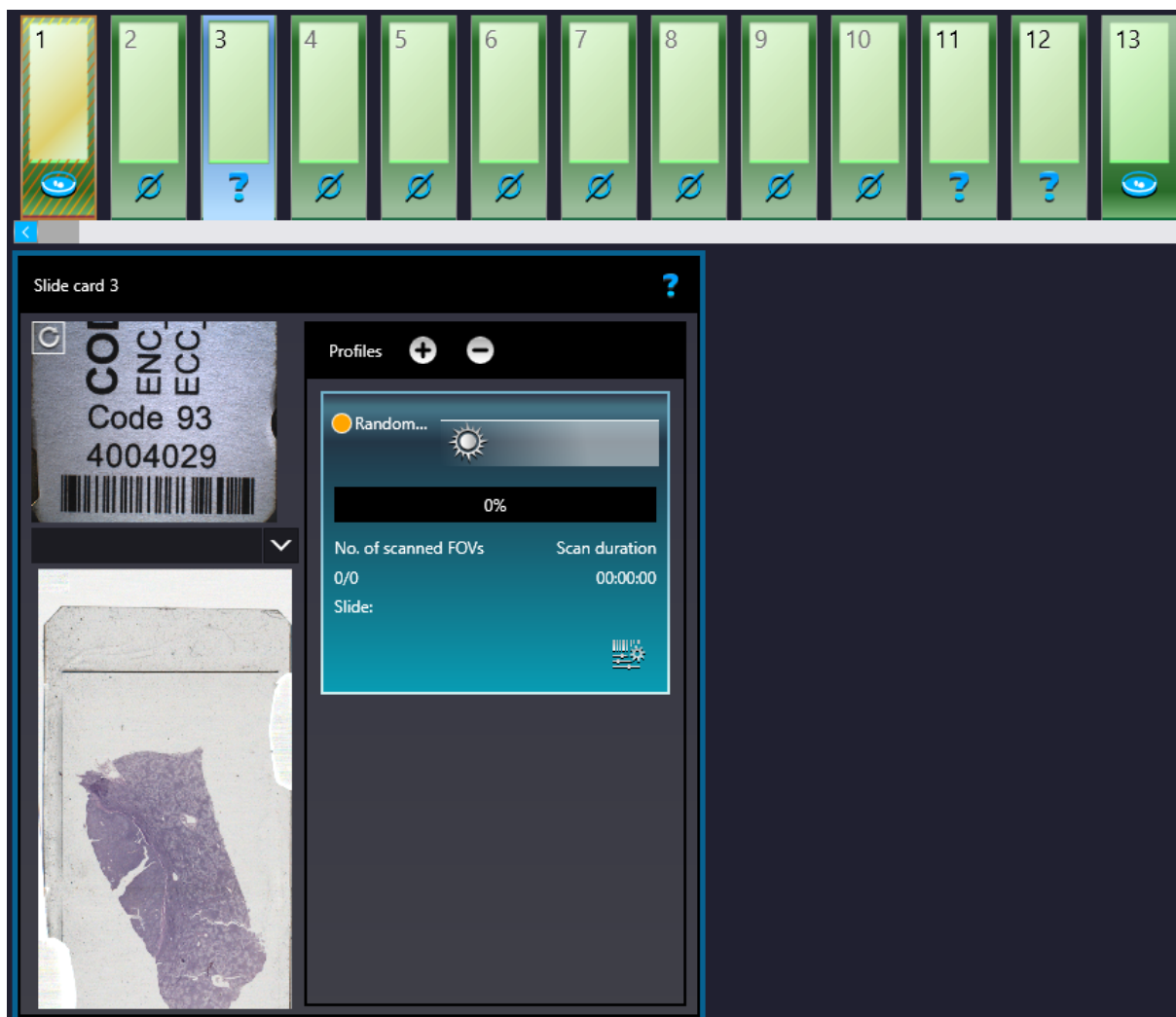



Figure 73 – Vertical slide view with card

By clicking  or  profiles can be added or removed for/from the slide, respectively. The parameters of the assigned profile is displayed in a card. The colors of a Brightfield and a Fluorescence profile cards are different.

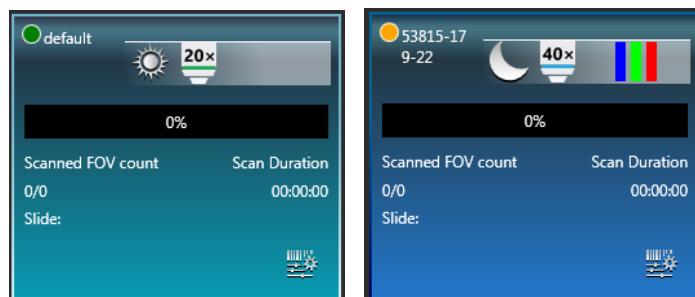







Figure 74 – Brightfield profile card and Fluorescence profile card

The following information are included in a profile card:

- Profile name in the top left corner
- Profile status is marked with spots of different color:
 -  – Stored
 -  – Edited
 -  – Draft
- Scanning mode icon representing Brightfield or Fluorescence mode
- Objective type
- Filter channel color bars (for FL mode only)
- Scan progress
- Scanned FOC count
- Scan duration
- Slide: actual status of the slide is presented here. If the slide is under scanning, the “Scanning”, if scanning has been interrupted by some error, the “Failed” text is visible.



NOTE: If slide status is marked as “Failed”, delete status before scanning by clicking .

If the virtual slide is created (the scanning is finished), the location path of the destination folder is displayed. To re-scan and thus recreate the slide, click  at the front of the displayed path to start the scanning process over.

- Scan properties 

5.3.5 Table view mode

By clicking  each slide will be displayed in a separate row.

Click  to assign profile to a slide, and  to detach a profile from a slide. A slide can have more than one profile assigned to it, and these profiles can either be BF or FL if the scanner is capable to operate in these two scanning modes.

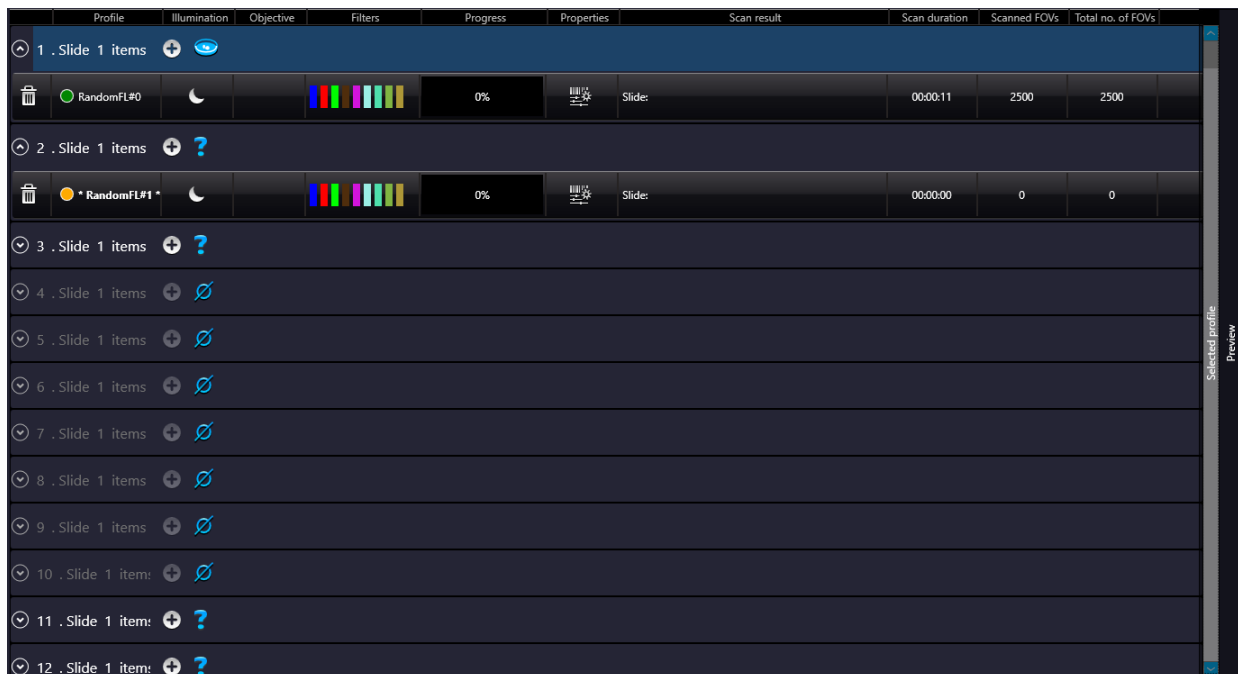





Figure 75 – Table view mode

In Table view the following information are displayed in the profile strip based on the loaded profile:

- Profile name
- Illumination
- Objective type
- Filters
- Progress
- Properties: The location of the virtual slide with the selected profile can be defined
 - Scan result
 - Scan duration
 - Scanned FOV'S
 - Total FOVs

5.3.6 Card collection view mode

If you click the  button, each of the slide previews are displayed in the window. Add profiles by clicking  and detach profiles by clicking . Functions are the same as with the other modes.

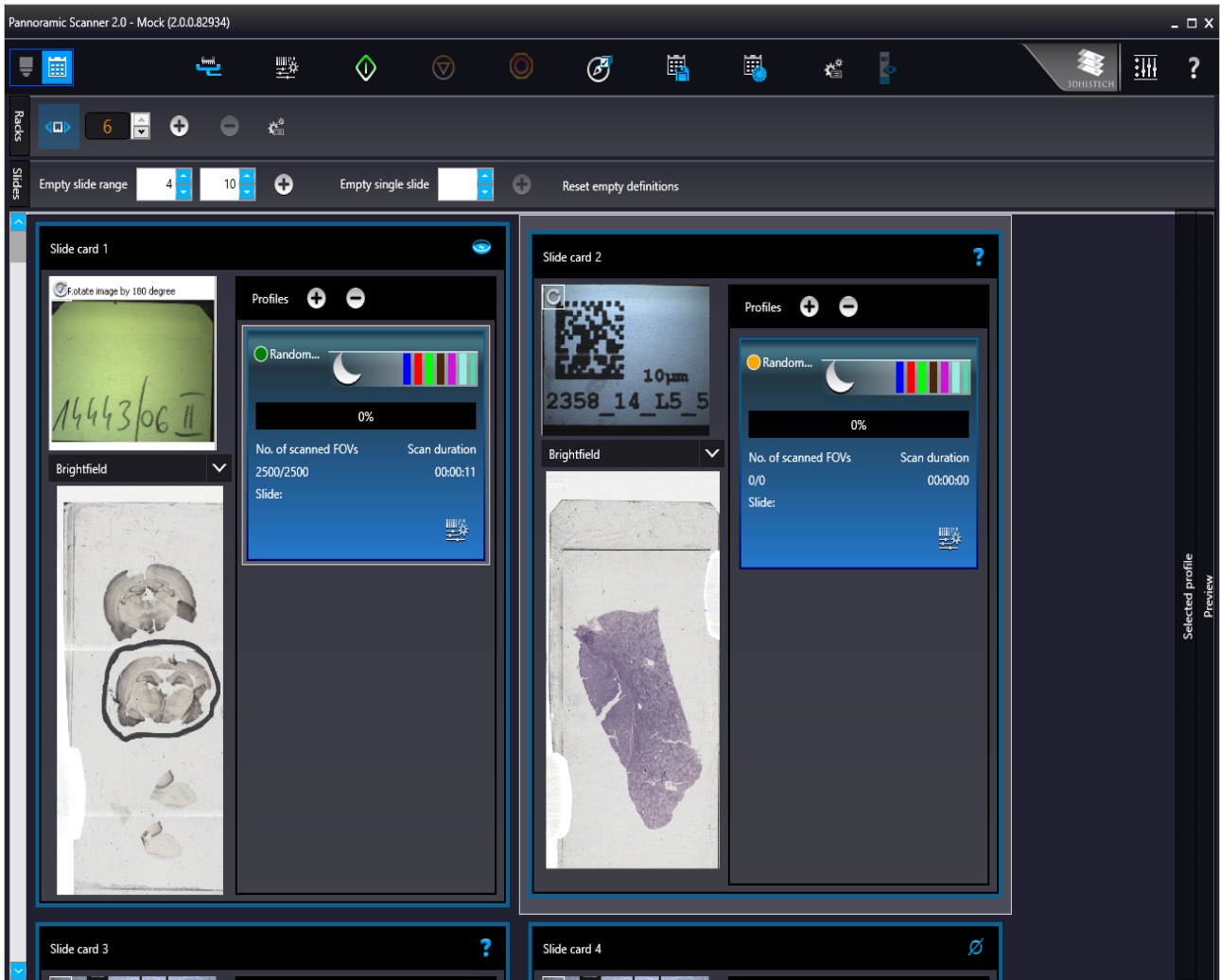

Figure 76 – Card collection view mode

5.4 Profile and Preview overview on the Planner

Each of the assigned profiles are checkable and modifiable. The expanding panel at the right side includes all of the profile settings, in coherence with the view type of the Profile Setting panel. Slide preview is displayed in the Preview window in which the scanmap can be modified until beginning the scanning process. Every aforementioned Profile setting can be modified depending on the scan profile type, being Brightfield or Fluorescence.

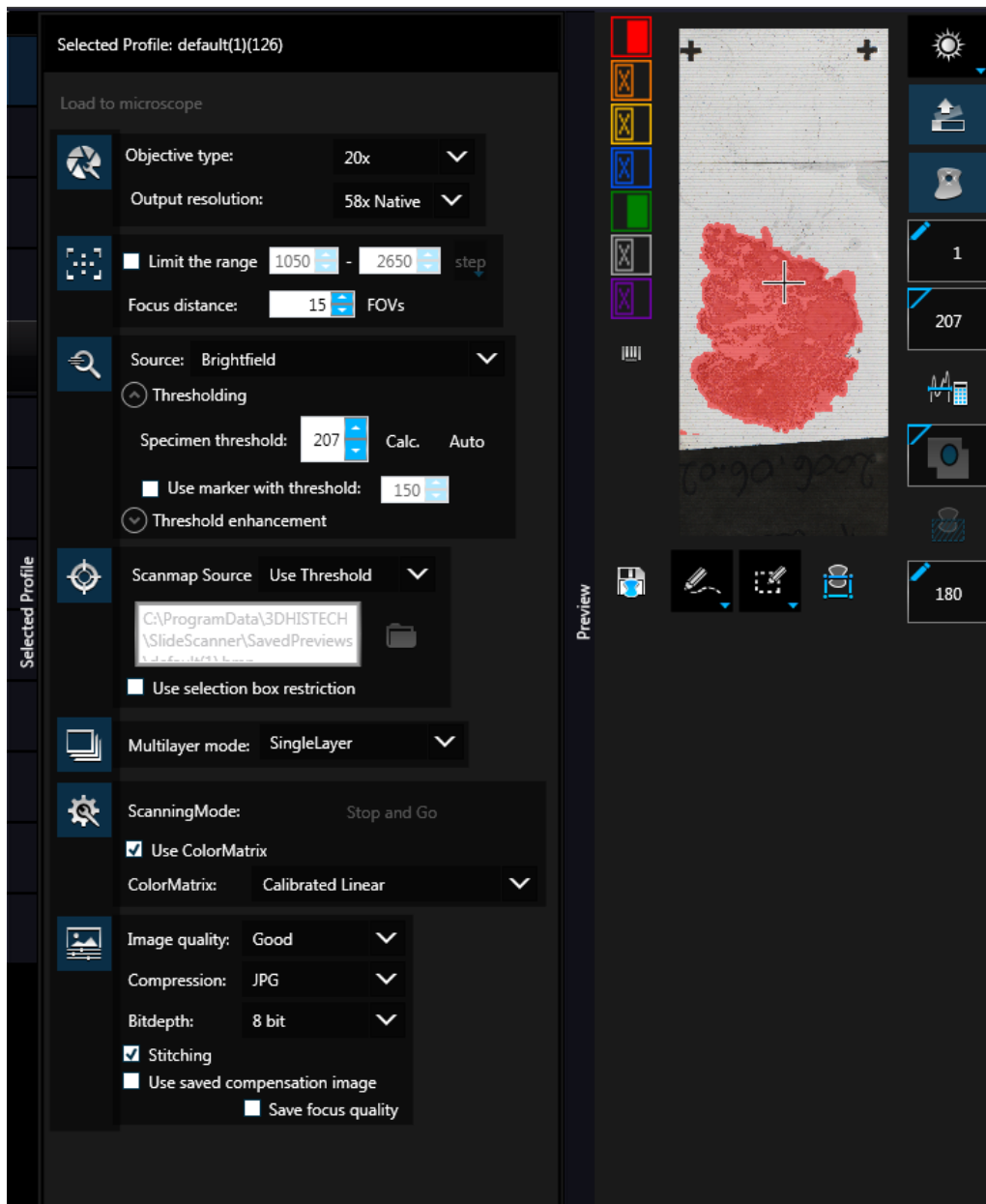
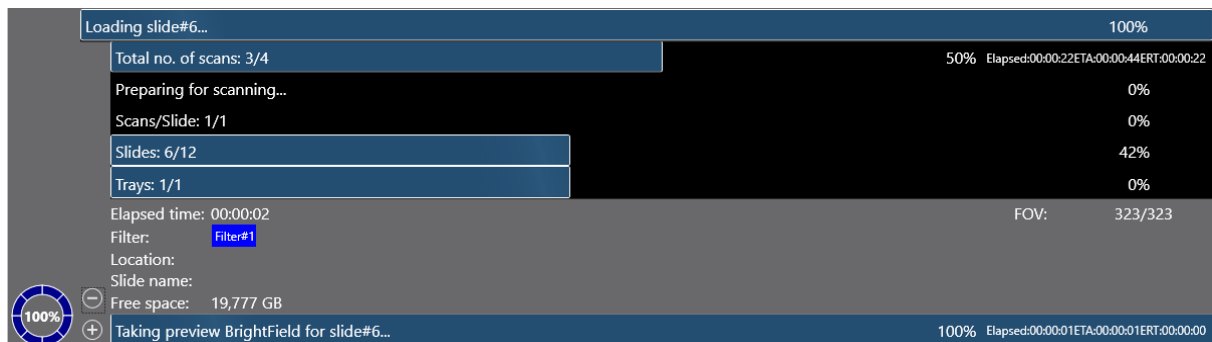

Figure 77 – Selected profile and expanded Preview window in Planner mode

5.5 Progress features

The progress is visible both in Microscope and Planner modes whenever there is a running hardware operation or scanning procedure. Progress content can be therefore different depending on the type of the running procedure.



The following information is included in the progress log list during scanning:

- Filter
- Elapsed time
- Location
- Slide name
- Free space
- FOV number

5.6 Services and Settings

Activate Services by clicking  and Settings by clicking  at the right side of the main menu bar.

5.6.1 Services

Activate **Services** by clicking  at the right side of the main menu bar.

-  – **Camera settings**
 - **Position**
 - **Objective type** – Select the type and the magnification level of the objective.

- **Magnification**
- **Use manual camera changer** – Changing the cameras is performed manually.
- **Prescan objective protection enabled** – If activated, slide area near the edges will not be scanned to record fast preview image. If inactive, Fast Preview processing becomes slower.
- **Cameras**
 Activate **BF** and/or **FL** mode for the camera. The software automatically loads the camera settings upon clicking the **Test and apply camera settings** button.

The screenshot displays the software's configuration panel for objectives and cameras. On the right, a 'Color matrix setup' dialog box is open, showing 'Custom color matrix' selected. The dialog has three rows for color calibration: RED, GREEN, and GREEN. Each row has input fields for Red, Green, and Blue values, with checkmarks indicating successful validation.

Position	Objective type	Magnification
Pos.1	Plan-Apochromat	20x
Pos.2	Plan-Apochromat	40x

Camera	Adapter	BF	FL
Point Grey GS3-U3-51S5M-C	0.63x	<input checked="" type="checkbox"/>	<input checked="" type="checkbox"/>

Color	Red	Green	Blue
RED	1.00	0.00	0.00
GREEN	0.00	1.00	0.00
GREEN	0.00	0.00	1.00

- **Brightfield ICC Profile**

Select an applicable preset color profile to be used for Brightfield scanning from the drop-down menu. Settings according to the profile has effect on the color set, color temperature, and gamma value of the scanned image.

Preset profiles are the following:

- **Calibrated Linear:** Color scheme is defined by calibration (Gamma value is not included)
- **sRGB standard:** Color scheme is defined by calibration (standard Gamma value -2.2- is applied)
- **sRGB standard Microscope Like:** Color scheme is defined by calibration (standard Gamma value / White Point: D50)
- **Legacy:** a Color scheme calibrated for the previous software version is applied
- **Custom:** parameters are freely customizable as follows:

- **Color Scheme**

- **Calibrated:** Scheme is defined by the color calibration slide
- **Legacy:** a Color scheme calibrated for the previous software version is applied
- **Raw:** the color information of the recorded raw image is applied

- **White Point**

- **D65:** color temperature according to a standard illuminant D65 white point value is applied (6500K / daylight)
- **D50:** color temperature according to a standard illuminant D50 white point value is applied (5000K / horizontal daylight)

- **Gamma**

- **Standard:** a value of 2.2 is used
- **Medium:** a value of 1.8 is used
- **Off:** a value of 1.0 is used



Note:

If Lumencor SPECTRA 6 is configured as illumination unit, the corresponding **Enable Lumencor hardware trigger** option is displayed on the **Filter settings** form.

- **Current threshold** – Set the desired threshold level in the box.
 - **Use selection box** – If selected, only the area inside the box is scanned. It is useful if you only want to scan the area that is equivalent with the size of the coverslip, so external specks will not be scanned.
- **Stitching overlap** – Set the amount how much the FOVs should extend over
- **Measure camera rotation** – Camera rotation angle is measured
- **Alpha blending** – The two images are blended
- **Lower image position** – Moves the upper image sideways in distinctive steps
- **Reset all camera rotation** – Click this button to set camera rotation values to default.

Save settings by clicking  .

-  – Filter settings

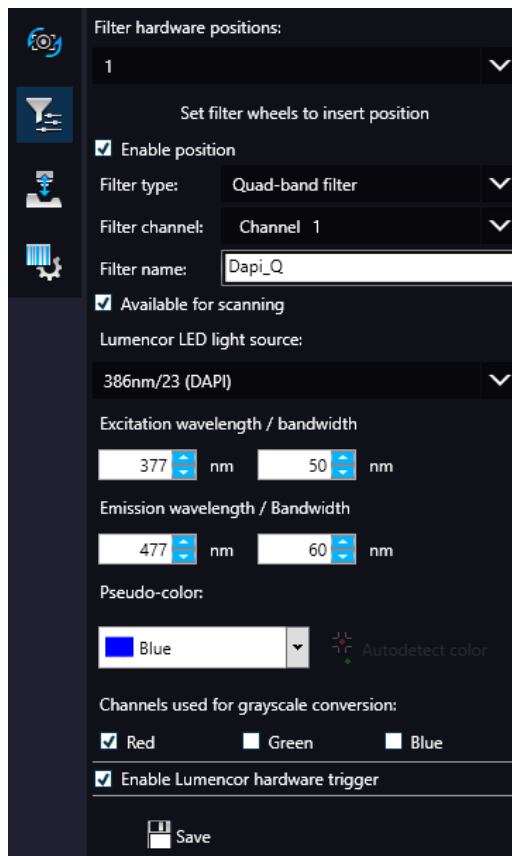

The screenshot shows the 'Filter settings' panel with the following configuration:

- Filter hardware positions:** 1
- Set filter wheels to insert position**
- Enable position**
- Filter type:** Quad-band filter
- Filter channel:** Channel 1
- Filter name:** Dapi_Q
- Available for scanning**
- Lumencor LED light source:** 386nm/23 (DAPI)
- Excitation wavelength / bandwidth:** 377 nm / 50 nm
- Emission wavelength / Bandwidth:** 477 nm / 60 nm
- Pseudo-color:** Blue (Autodetect color is also visible)
- Channels used for grayscale conversion:**
 - Red
 - Green
 - Blue
- Enable Lumencor hardware trigger**
- Save** button

On this panel you can define which filters occupy which turret positions.

- Select filter hardware positions from the drop-down list
- Move filter wheel to insert position
- **Enable position**
- Select **Filter type**, **Filter channel**, and **Filter name**

- Check **Available for scanning**
- Set **Lumencor LED light source**, set **Excitation** and **Emission wavelength / bandwidth** values for the selected filter.
- Set **Pseudo-color**
- Select channels used for grayscale conversion
- Select **Enable Lumencor hardware trigger**

Click **Save** to save settings.

-  – **Z-difference**

This function is available only for fluorescence settings; it enables you to set the basic focus differences between the filters. This facilitates more precise focusing during scanning.

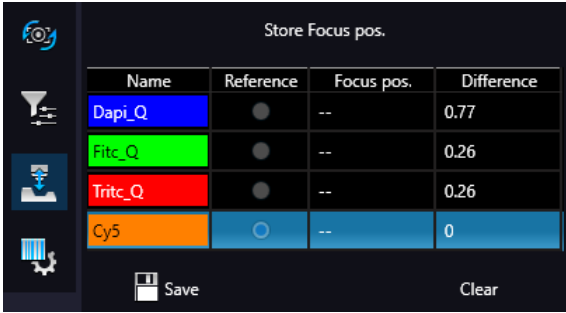

Name	Reference	Focus pos.	Difference
Dapi_Q	<input type="radio"/>	--	0.77
Fite_Q	<input type="radio"/>	--	0.26
Tritc_Q	<input type="radio"/>	--	0.26
Cy5	<input checked="" type="radio"/>	--	0

-  – **Barcode settings**

By predefining barcode type, foreground color (black or white – the color of the barcode), and other settings, you enable the **Read Barcode** option when using the control software.

To display an image of the barcode area, click  . You can redefine the barcode reading area by dragging the edges of the blue square.

To check whether the barcode reading settings are correct, display the barcode digits in the **Barcode** field by clicking  . If the label area is not correctly illuminated, adjust **Barcode LED intensity** value.

Click  to check that barcode settings are correctly set.

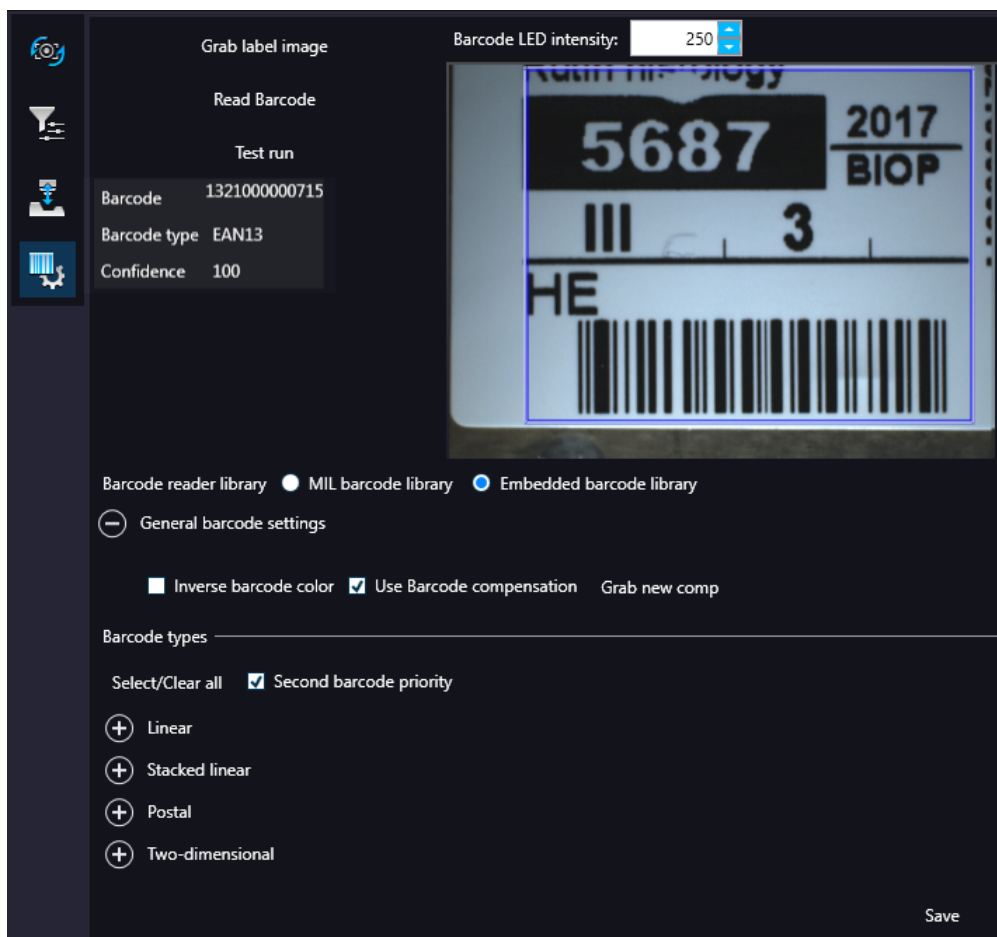
**Note:**

If you did not set the barcode type correctly, or there is no barcode in the barcode area, the software will display the following error message: *“Barcode detection unsuccessful! There might be no barcode present.”*

- **Barcode reader library**
 - Select **MIL barcode library** or **Embedded barcode library**
- **General Barcode settings**

- **Inverse barcode color**

Activate to invert foreground and background colors of the barcode.

- **Use barcode compensation**

A compensation image is used during barcode reading

- **Grab new comp**

Click this button to create a new compensation image for barcode.

NOTE: New compensation image for barcode can be recorded only if MIL is used for barcode identification.

- **Barcode types**

- **Linear**
- **Stacked linear**
- **Postal**
- **Two-dimensional**
- **Second barcode priority**

The software is capable to read two barcodes at the same time. If activated, the second barcode will be the barcode used for slide identification.



Note:

When having two barcodes on the slide, barcode layout must be consequential.

-  – External application call

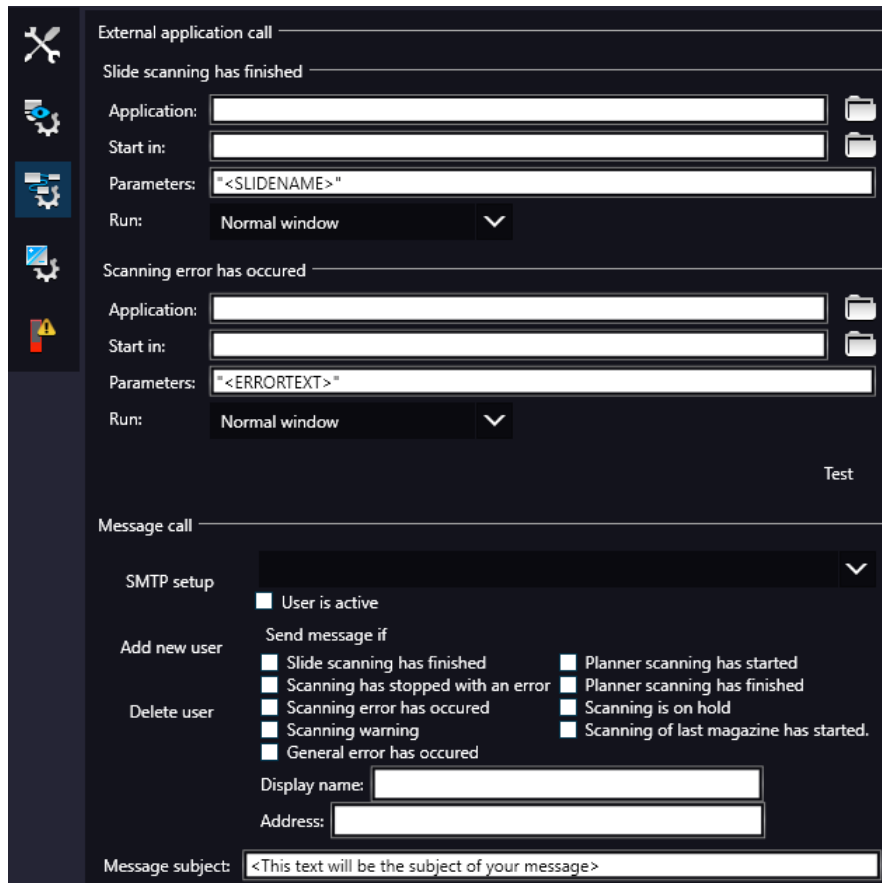

Two of the three settings are responsible for opening external applications (.exe or .bat) as defined (for example, CaseViewer software can be opened after scanning is finished).

You can define external application call settings for the following cases:

- Slide Scanning Finished
- Scanning Error Occurred

For **Slide scanning has finished** and **Scanning error has occurred** you can define the external software by entering the file path in the **Application** box, or by browsing for it by clicking  .

If you define parameters in the **Parameters** field, it will pass them to the software that it starts. If no parameter is defined, then the parameter will not be passed. The default parameters are the following:

- For **Slide scanning has finished**: "<SLIDENAME>" – transfers the slide name

- For **Scanning error has occurred**: "<ERRORTEXT>" – transfers the error message

Run defines the window mode that the external application will start in. The following window modes can be set:

- Normal window
- Minimized
- Maximized

You can test whether the **Scanning Error Occurred** settings work by clicking .

In the **Message Call** section of the window complex messaging functions can be defined. Here you can setup parameters of the mail server, add or remove users, and also set the message body in the **Message subject** field by entering a text for example, to inform recipients on the location of the scanner, or the slide set you are working with.

Click  to test settings (by sending an e-mail to the address defined in the **E-mail To** field) after you have finished to check their relevancy before applying them.

First click **SMTP setup** to display the E-mail settings window, in which you can dedicate an e-mail server through which the software sends e-mails to the selected recipients.

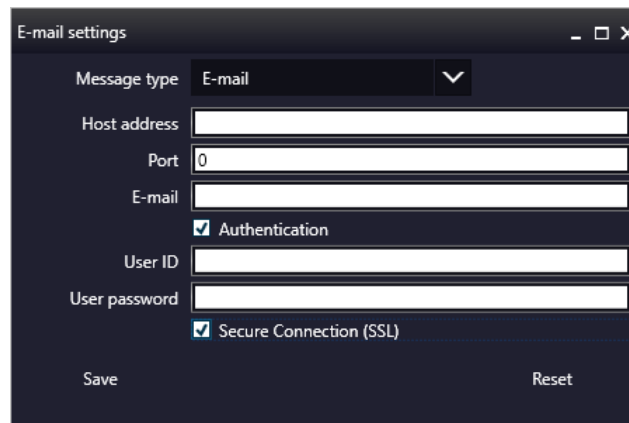



Figure 78 – Messenger Setup window

In the Messenger Setup window the following parameters can be set:

- **Message Type** – E-mail
- **Host Address**
- **Port**
- **E-mail**
- **Authentication** – **User ID** and **User password** are required.
- **Secure Connection (SSL)** – If activated, the messages will be sent through secured connection.

- If you have properly set messenger settings, click **Save**.
 - Click **Add new user** in the **Message Call** section of the External application call settings window then enter **Display name** and **Address** of the recipient. Select message functions under the **Send Message if:** field for the selected recipients (from the drop-down list at the top of the section).
 - Click **Delete user** if you want to remove a user from the list after selection.
-  – **Image compensation**

You can use a saved compensation image whenever compensation-related issues occur (deriving from the slide, illumination, staining or embedding medium irregularities).

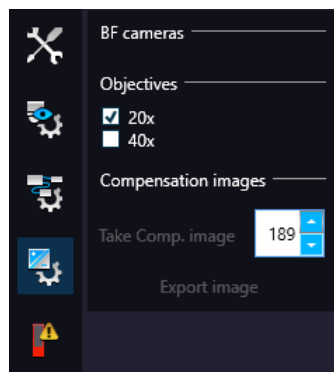

- **BF cameras** field displays the active camera. Currently, there is only one active camera for Brightfield mode.
- **Objectives** field displays the objective used for scanning.

There might be specks or minor etches on the surface of the compensation slide that require modifying the threshold settings. Therefore, the scanner will not use those areas for the creation of the compensation images.

To modify the threshold settings, set the desired threshold value in the box.

To create the compensation image(s), click **Take Comp. image**. Click the **Stop** button to interrupt the process. The progress bar at the bottom of the window displays the progress of the compensation image creation.

- **Export image** – Save compensation image.

-  – **Emergency slide operations**

This panel contains control and maintenance functions.

- **Emerg. position**

The slide holder will be moved to a position where the slide can be removed manually after opening the cover (see section [7.3.1 Opening the protective covers](#)).

- **Slide removed**

Click this button to notify the software that you have removed the slide manually.

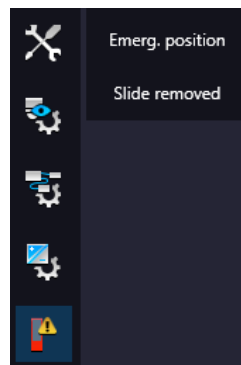

5.7 Hosting

Hosting a live teleconsultation session gives specialists the opportunity to examine the same Live microscopic image during a real-time counseling even if being in laboratories far away from each other. This means multiple users can connect to the device at the same time. The user of the scanner will be the host with direct access to the scanner.



Note:

Both the client's and the host's scanner software version must be identical.

Once client users have connected, they will be able to reach the following functions of scanner:

- Live image
- Preview window
- Profile content
- Stage control

Each participant see the same live image within the same preview window. The active user can navigate on the slide and set up a scanning profile. The **Start scan** function is also available for the active user. Each participant can make comments in a chat window while examining the slide image.

Hosting a teleconsultation session

1. Select **Hosting** from the microscope mode menu
2. Type in your nickname used during the session
3. Click **Start hosting**
4. The software displays the hosting address and the port number

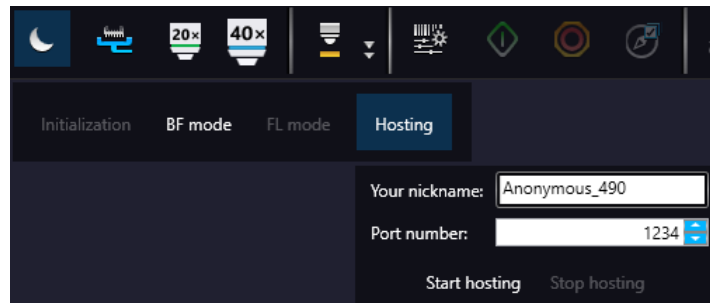

Join teleconsultation as a client

1. Start the *Lite* version of the scanner software
2. Type in your nickname used during the session
3. Enter **Host address** and **Port number**
4. Click **Connect**

On Client side the following functions are unavailable/inactive:

- Selection box
- Scan properties
- Separate scanning



Note:

During a fluorescence Live consultation the shutter of light path will be closed automatically during the host time in order to save the sample from the burnout effect.

5.8 Using Profiles

**Note:**

Saved profile settings cannot be applied if using a different type of Pannoramic scanner.

If you want to scan a group of slides, it is advised to save your settings previously in a profile and continue scanning in Automatic mode. You can save the following settings in a profile:

Scan Mode

- Brightfield
- Fluorescent

Scan Options

- Focus frequency (in Fluorescent mode)
- Focus frequency (in Brightfield mode)
- Compression procedure
- Use of a fixed compensation image (in Brightfield mode – ON/OFF)
- Use of Save focus quality (ON/OFF)
- Use of stitching (ON/OFF)

Determination of the area to be scanned

- Use of automatic threshold specimen
- Use of specimen threshold value
- Use of marker pen threshold and specimen threshold values
- Use of scan everything within marked area (ON/OFF)
- Remove coverslip function (ON/OFF)
- Filling of holes (ON/OFF)

- Use of removing specks according to the set value (ON/OFF)
- Use saved scan area
- Use selection box (ON/OFF)

Fluorescent settings

- Filter position(s)
- Selected focus channel
- Selected stitching channel
- Flat field correction (ON/OFF)
 - Intensity statistics
 - Intensity reducing
 - Intensity equalization
- Sharpening (ON/OFF)
- Use of skip empty field-of-views (ON/OFF)
- Do not use extended focus on empty field-of-views (ON/OFF)
 - Custom extended focus

Other settings

- Limitation of focus range (ON/OFF)
- Enable/disable Multilayer options
- Use of extended focus or Z-stack step size and focus level
- Output resolution

6 Troubleshooting and Maintenance

6.1 Safety Information

Check cables, plugs and connections before operation, and if defective or cannot be replaced, contact Thermo Fisher Scientific Service for support.

Check whether the device is compatible with your local line voltage. It can operate at line voltages 100V to 240V and 50/60 Hz.

Only plug the device in a socket with protective grounding (earth) contact.

Do not operate the device in explosive environment.

Disconnect the device from the power outlet before opening it or replacing a part.

The product is not equipped with protection against hazardous materials (infectious, toxic, radioactive, corrosive substances or other effects damaging to health). Decontaminate infectious materials after use.

Slides that are not used any longer do not classify as domestic waste and must be treated as hazardous materials and disposed in compliance with the currently valid legal requirements.

Dust, specks and humidity may decrease or harm the operating capability of the device. Protect it with dust cover when not in use. Switch the power off before covering it.

Avoid touching the lamp bulb. Wait for about 15 minutes to allow the bulb to cool down and disconnect the power plug before changing the bulbs.

There is crush hazard during operation in the area of input or output. Inserts/magazines should be moved through software. Never open the device unless prompted accordingly by the software.

Defective devices do not classify as domestic waste. Dispose of the device in compliance with the currently valid legal requirements.

Lumencor SPECTRA 6 illumination unit

- **NEVER** switch on the Lumencor SPECTRA 6 Light Engine illumination unit when it is not connected to the microscope.
- Ensure that the light source is properly connected.
- Do not cover the unit, as it would cause abnormal temperature rising.

Lumencor SOLA SM II illumination unit

- Keep inflammable and combustible materials outside the range of **Lumencor SOLA SM II** illumination unit.
- Do not expose yourself to the UV radiation of the **Lumencor SOLA SM II** illumination unit.
- When the **Lumencor SOLA SM II** illumination unit is switched on:
 - **NEVER** look directly into the fiber-optic cable.
 - **NEVER** remove the fiber-optic cable from the device.
 - **NEVER** connect the fiber-optic cable to the device.
 - **NEVER** remove the housing from the device.

6.1.1 Cleaning the device

- Before cleaning, switch off the device and pull the plug out.
- Do not let liquid penetrate into the system.
- To clean liquid from the device, use a lint-free cotton cloth. You can moisten the cloth with water.
- To clean greasy surfaces, it is recommended to apply **soapy water** on a piece of lint-free cotton cloth and gently rub the surface.

6.1.2 Cleaning the magazine

Do not clean the magazines with xylene, because it might harm the plastic. We recommend to apply **Isopropanol** on a piece of lint-free cotton cloth and gently rub the surface instead. In case the magazine is damaged, use either order a new one, as inserting a deteriorated magazine could lead into unsafe loading of slides.

6.1.3 Preventive maintenance**To prevent fungus growth**

- Do not leave the equipment in an unconditioned environment with a storage temperature above 60°C (140°F) or below 0°C (32°F), which may damage the equipment.
- Maximum operating temperature is 35°C (95°F) with a relative humidity of less than 75%.
- Install it in a room with proper air ventilation.
- Do not let dust or fingerprints remain on optical surfaces.

6.2 Troubleshooting

This section describes the most common troubleshooting solutions for the Pannoramic SCAN II product. If any problem arises that does not have solution in this manual, contact Thermo Fisher Scientific service support.

The product does not start

- **Power supply is interrupted**
 1. Make sure that the 24V external power supply is on.
 2. Check cable connections.

Control software has stopped

- **Slide jammed**
 1. Exit control software.
 2. Switch off control computer and 24V power supply, disconnect power cable.
 3. Remove protective covers. Follow the steps in section **5.3.1 Removing the protective covers**.
 4. Remove slide manually (see section **5.3.4 Removing a slide**).
 5. Reattach protective covers.
 6. Reconnect 24V power supply and control computer to line power supply.
 7. Switch on the 24 V power supply.
 8. Switch on the control computer.
 9. Launch control software.

- **Magazine jammed**
 1. Exit control software.
 2. Switch off control computer and 24V power supply, disconnect power cable.
 3. Remove protective covers (see section **5.3.1 Removing the protective covers**).
 4. Remove magazine manually (see section **5.3.6 Removing the Magazine from the Transporting System**). If a jammed magazine cannot be removed, contact service personnel.
 5. Reattach protective covers.
 6. Reconnect 24V power supply and control computer to line power supply.
 7. Switch on the 24 V power supply.
 8. Switch on the control computer.
 9. Launch control software.

Virtual slide is improperly focused almost across its entire surface

- **Focus range enabled**
 - Disable **Limiting focus range**.

Poor image quality

- **Imaging error (for example, chromatic aberrations)**
 - Contact Thermo Fisher Scientific Service for support.

**Warning!**

Do not modify the camera driver settings, as the default factory settings give the most accurate images.

Virtual slides show poor stitching in Pannoramic Viewer

- **Scan camera not properly adjusted (for example, due to loose fixture)**
 - Contact Thermo Fisher Scientific Service for support.

Slide is often positioned incorrectly

- **Guiding fault in transport system**
 - Check if faulty positioning disappears after the selection of a different type of magazine (for example, universal magazine).
 - Contact Thermo Fisher Scientific Service for support.

Digitization process is extremely slow

- **Extended focusing option is activated**
 - Deactivate the **Extended focusing** option if not required.
- **Z-stack option is activated**
 - Deactivate the **Z-stack** option if not required.

Image is out of focus (in Manual mode)

- **Focus range limit is activated**
 - Deactivate the **Limiting focus range** option.

- **Focus range setting is incorrect**
 - Change focus range setting.

All individual images show a shading effect

- **Algorithm failed to find empty image fields**
 - Capture a reference image with a blank slide (see section **4.2.2 Image Compensation**).

6.2.1 Fluorescent Applications (optional)

The switching of the Lumencor SPECTRA 6 cannot be triggered, in spite of trigger connection through the camera.

- Contact Thermo Fisher ScientificService for support.

No suitable exposure time can be found. Signal is too weak.

- **Lumencor SOLA SM II is switched off**
 - Switch light source on, otherwise contact 3Thermo Fisher ScientificService for support.

6.3 Maintenance

This section describes the most common maintenance solutions that can be performed by the user of the product. For maintenance solutions not described in this manual, contact the service personnel.

6.3.1 Removing the protective covers

To perform maintenance work and because of slide or magazine jamming, the protective covers of the Pannoramic SCAN II need to be opened in order to eliminate the problem.

Before removing the covers, exit the control software, switch off the 24 V power supply and disconnect the power cables.

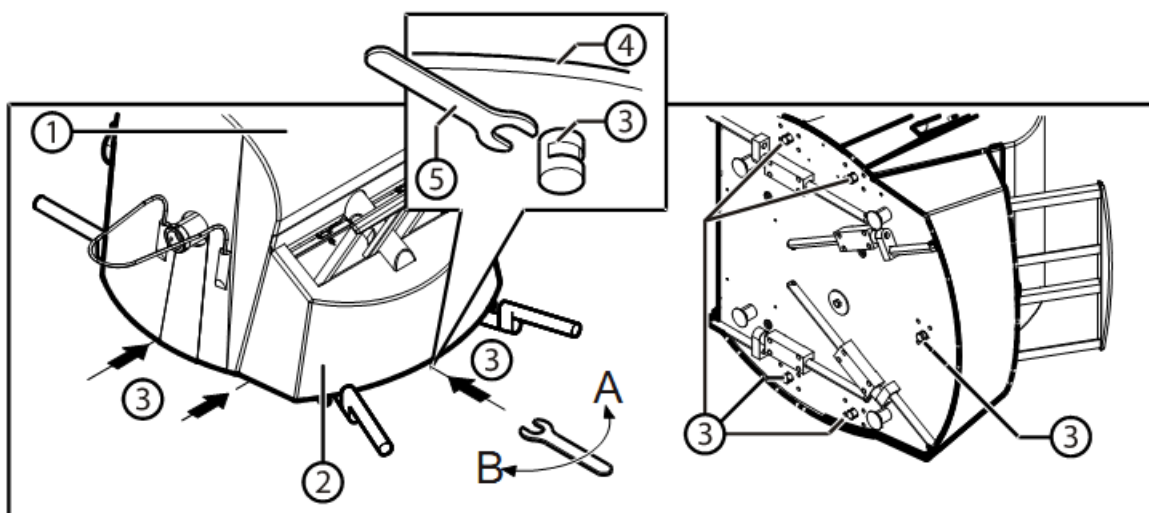
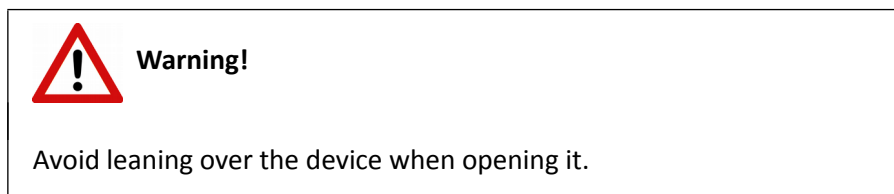

Figure 79 – Removal of covers

Five eccentric screws **(3)** are located on the bottom face of the base plate **(4)**. They attach the covers to the base plate.

1. Use an open-end wrench (W/F 10) **(5)** to turn the screws **(3)** on the lateral sides of the Pannoramic SCAN II by 90° anticlockwise, proceeding pair-wise **(B)**. Use both hands to take cover **(1)** carefully off upwards.

**Caution!**

Use caution to prevent contact between the safety rails and the scan camera as you take cover off.

3. Turn eccentric screw at the front of the base plate by 90° anticlockwise and use both hands to carefully raise and take cover **(2)** off.
4. After finishing the necessary maintenance or repair work, put the covers (cover **(2)** at first, then cover **(1)**) back into place and lock them in their positions. To do this, turn the eccentric screws clockwise **(A)**.

**Caution!**

Make sure that no cables of the scan camera are squeezed as you replace the covers.

6.3.2 Removing a slide

If a slide got jammed or has suffered breakage during the process of digitization, stop the process and, if possible, move the slide holder to a position where the slide can be easily removed by clicking the **Emergency Manual Slide Removal Position** button (see section [4.3.6 Service panel](#)).

**Warning!**

Crush hazard! Before you remove a jammed slide, cancel the running digitization process, terminate the software session and turn the power off.

**Caution!**

Any manipulation performed on a mechanical component must be followed by a complete device initialization routine (software restart).

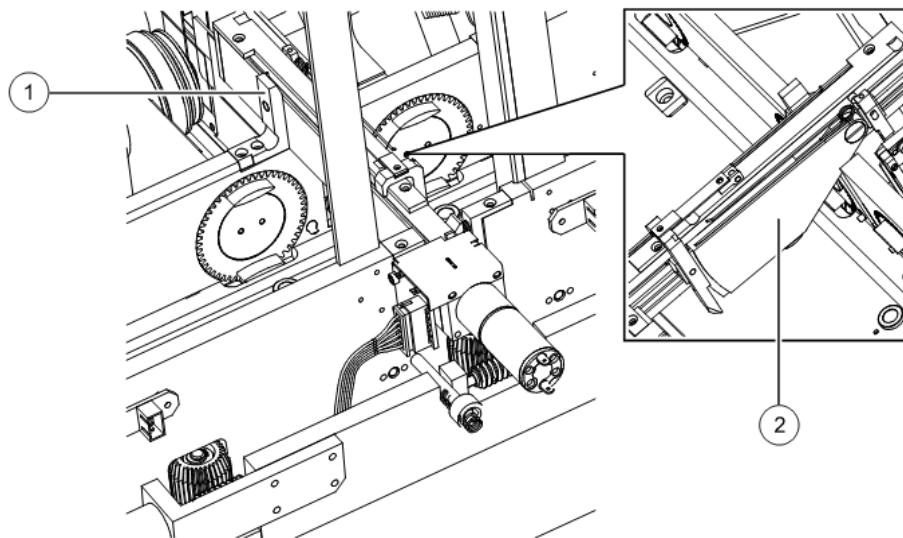

Figure 80 – Removing the slide loader

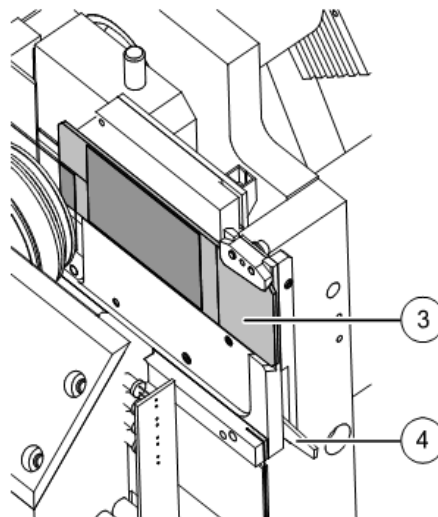

Figure 81 – Removing a slide

1. Open the protective cover (see section **5.3.1 Removing the protective covers**).
2. Push locking lever **(1)** to the left, and keep the lever in this position.
3. Seize the slide loader **(2)** by the end where the lever is and turn it up by the necessary degree to make the removing of slide possible.
4. Remove slide loader unit.
5. Press clamping lever **(4)** down. The slide position lock releases.
6. Retrieve slide **(3)** from the holder.

**Caution!**

If the slide is broken, make sure to remove all pieces completely from the device. The edge of the broken area of the slide is sharp and it can lead to injury and contagion! Broken slide can be removed only by a well-trained person!

7. Release clamping lever **(4)** and turn down the slide loader **(2)** back into the original position and pull it inwardly, until the guiding pin connects with the motor block groove again.
8. Press the slide loader down to mechanical stop position, in which the locking lever must engage **(1)**. Use moderate force to press the loader part opposite the motor in clamp direction **(2)**, until this part mechanically engages, too.
9. Close the protective cover again (see section **5.3.1 Removing the protective covers**).
10. Launch the control software.

6.3.3 Installing and Removing the Filter Module (Fluorescent Option)

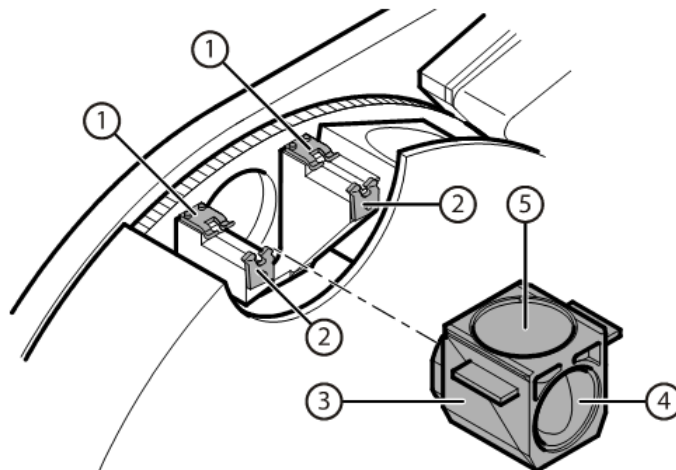

Figure 82 – Installing and removing the filter module

1. If using a Lumencor SOLA SM II illumination unit, turn it off.

**Warning!**

Crush hazard! Stop the running digitization process before you proceed with filter module installation or removal.

2. Pull protective cover halves apart or remove the right part completely (see section **5.3.1 Removing the protective covers**).
3. Select the desired filter in the corresponding software window (see section **4.2.3 Microscope Settings / Filter Settings**). The filter will be positioned in such a way that the user can access it without having to turn the filter wheel manually.
4. Enter the respective parameters in the input fields.

**Warning!**

Crush hazard! Rotating the filter turret motorically during installation or removal may lead to injury.

5. Hold the filter module **(3)** by its handling pads (one on the right, one on the left (lateral) side of the module) and insert it in forward tilted position from above into the upper spring-loaded clamps **(1)** at the filter wheel.
6. Press the filter module down, until it safely connects to the bottom spring-loaded clamps **(2)** of the filter wheel. Mounting position of the filters: excitation filter **(5)**; emission filter **(4)**.
7. To remove the filter module, first slightly tilt it out of its upper spring-loaded fixtures, then pull it out of the bottom spring-loaded components and take it off.
8. Place the protective covers back again (see **5.3.1 Removing the protective covers**).
9. If a Lumencor SOLA SM II illumination unit is used, turn it on again (consider the cooling time possibly required).

6.3.4 Removing the magazine from the transporting system

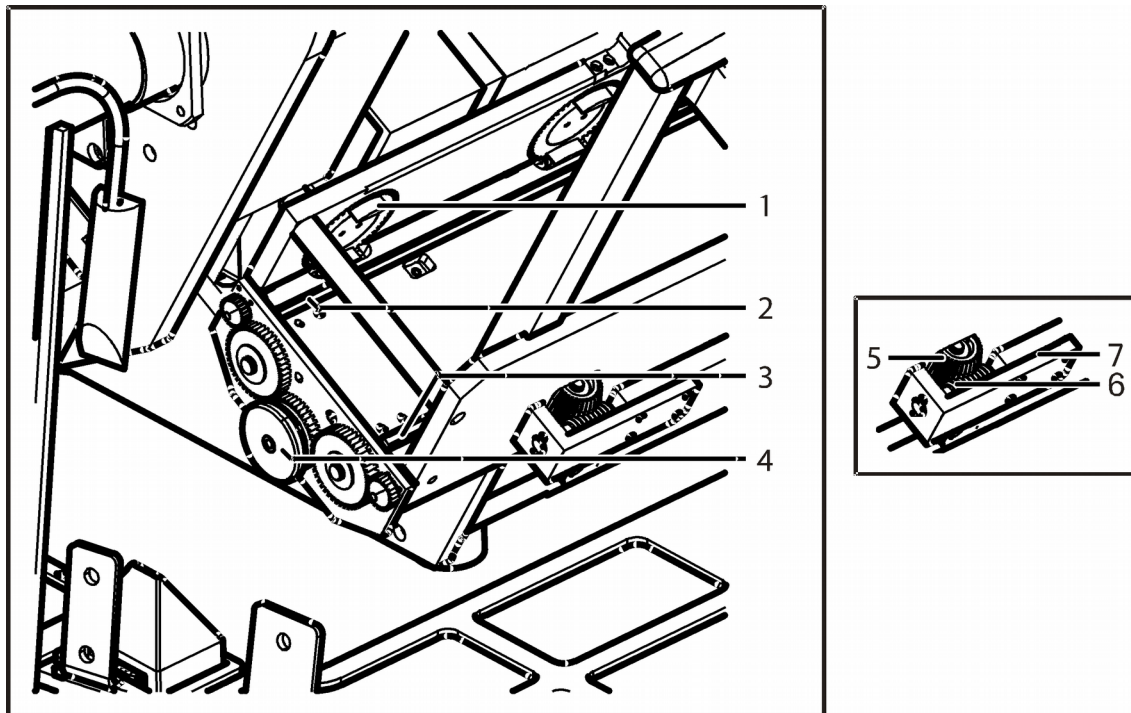

Figure 83 – Removing a magazine

1. Remove the protective covers (see section [5.3.1 Removing the protective covers](#)).



Warning!

Crush hazard! Remember to stop the running digitization process, terminate the software session and turn off the power supply before removing a jammed magazine.



Caution!

Check that the magazine is not tilted, so that it rests on both of the horizontal guide rails.

2. If the magazine is in horizontal position, tilt plate **(7)** with the drive assembly for horizontal magazine drive motion to the front far enough for the driving gear **(5)** to disengage from the driving worm gear **(6)**.
3. Push the magazine on the guide rails **(2-3)** to the left or to the right to remove it from the transporting system.
4. If the magazine is tilted because of twisted tappets **(1)**, first restore the tappets to their initial position. They are correctly positioned if vertically aligned exactly one above each other. Turn the knurled wheel **(4)** by hand, until the tappets are in their initial position again and the magazine flatly rests on both horizontal guide rails.

**Note:**

Any manipulation performed on a mechanical component (for example transporting system) by the user must be followed by a complete Pannoramic SCAN II initialization routine (software restart).

6.3.5 Transporting Pannoramic SCAN II

The following procedure shows how to transport the Pannoramic SCAN II in-house.

For transporting the whole system to other location, see **Appendix**.

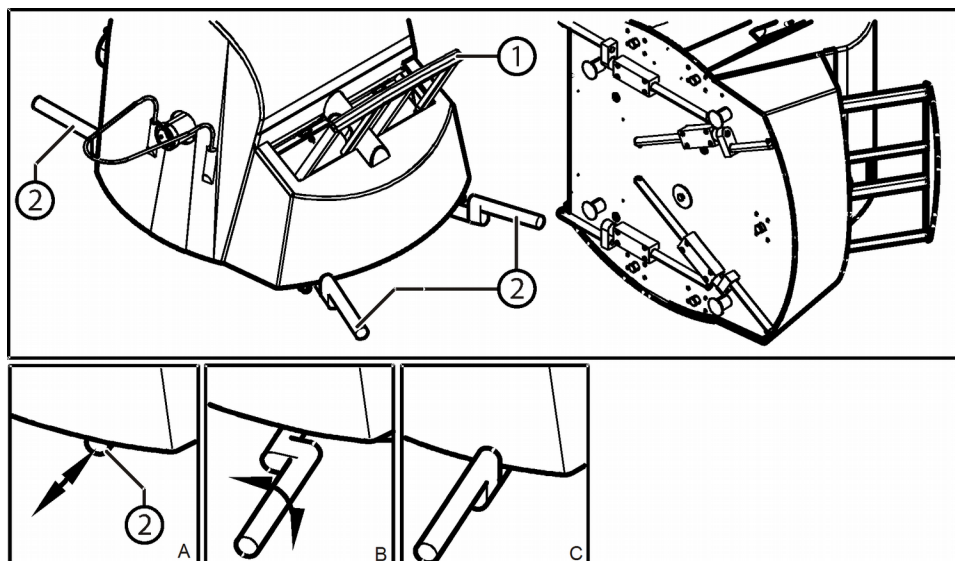

Figure 84 – Transporting handles

**Caution!**

Do not use the blue guide rail bar **(1)** to raise, shift or transport the Pannoramic SCAN II!

**Note:**

The base unit has four carrying handles for transporting. Two or four people can carry the base unit using these carrying handles. To determine the appropriate number of transporter people, observe the laws of your country regarding load carrying capacity limitations. You can find the weight data of the base unit in section **6. Technical Data**.

To transport the Pannoramic SCAN II do the following:

1. Turn power supply off and detach all cables.
2. Pull carrying handles out **(2)** until mechanical stop position **(A)**.
3. Turn carrying handles by 90° **(B)** towards the base unit to secure them.
4. Now you can transport Pannoramic SCAN II with the help of another person.
5. After finishing transportation, push carrying handles back into normal position **(C)**.

7 Technical Data

Dimensions (width x depth x height)

Base unit	approx. 740 mm (W) x 530 mm (D) x 450 mm (H)
Base unit without fluorescence option	approx. 740 mm (W) x 530 mm (D) x 450 mm (H)
24V 100W power supply	approx. 189 mm x 90 mm x 44 mm

Weight

Base unit	approx. 26kg
Base unit with fluorescent option	approx. 29 kg
24V 100W power supply	approx. 550 g

Ambient conditions

Transportation / shipment (packed)

Permissible ambient temperature	-40°C to +70°C
---------------------------------	----------------

Storage

Permissible ambient temperature	+0°C to +60°C
Permissible relative air humidity (non-condensing)	75%

Operation

Permissible ambient temperature	+10°C to +35°C
Permissible relative air humidity	75%
Altitude at installation site	max. 2000 m
Atmospheric pressure	500 hPa to 1060 hPa
Degree of pollution	2

Operating data

Intended site	closed room facilities
Electrical protection class	I
Internal protection degree	IP 20
Electrical safety	in compliance with IEC 61010-1:2010, IEC 61010-2-101:2015, IEC 61010-2-081:2015
Over-voltage category	II
Radio interference suppression	in accordance with EN 55011 class B
Noise immunity	in accordance with EN 61326-2-6:2012
Base unit input voltage	24V DC \pm 1V
Power consumption of the complete device	60 VA

SINPRO MPU101-108 – 24V external mains power supply unit

Intended site	closed room facilities
Electrical protection class	I
Internal protection degree	IP 20
Electrical safety	in compliance with UL 2601-1, TÜV EN 60601, CE EN60601-1-2:2001
Over-voltage category	II
Radio interference suppression	in accordance with CISPR-11 EN 55011 class B
Line input voltage	100 V AC to 240 V AC
Line input frequency	50 / 60 Hz
Power consumption	max. 100 VA
Secondary voltage	24V DC
Secondary current	max. 4.8 A

Light sources

Transmitted light source	Multichannel LED-based with wide Red, Green, Blue emission
Average service life of transmitted light source	~ 30000 hrs
Fluorescent light source	Lumencor SPECTRA 6 or SOLA SM II Light Engine
Estimated service life of Fluorescent light source	~ 20 000 h

This User's Guide describes Lumencor Spectra 6 Light Engine and Lumencor SOLA SM II as light sources.

Scan cameras

Point Grey Grasshopper3 (GS3-U3-51S5M-C) Global Shutter Type CMOS (Sony IMX250)	
Pixel size	3.45µm × 3.45µm
Camera resolution	2448 (H) × 2048 (W) pixel
Frames rates	75 fps
Bit-depth	10-bit / 12-bit
Pixel resolution with 20x objective and 0.63x C-mount adapter	0.27 µm
Pixel resolution with 20x objective and 1x C-mount adapter	0.17 µm
Pixel resolution with 40x objective and 0.63x C-mount adapter	0.14µm
Pixel resolution with 40x objective and 1x C-mount adapter	0.09 µm
Connection type	USB 3.0
pco.edge 4.2 13.3 mm × 13.3 mm sCMOS (CIS2020)	
Pixel size	6.5 µm × 6.5 µm
Camera resolution	2048 x2048 active pixel
Camera max. speed	100 fps at full resolution (2048 × 2048 pixel)
Bit-depth	16 bit
Pixel resolution with 20x objective and 1x C-mount adapter	0.33µm
Pixel resolution with 20x objective and 1.6x C-mount adapter	0.20µm
Pixel resolution with 40x objective and 1x C-mount adapter	0.16µm
Pixel resolution with 40x objective and 1.6x C-mount adapter	0.10µm
Cooling	Peltier with forced air (fan)
Connection type	Dual Camera Link Full (10 taps, 85MHz)

Control computer, minimum system requirements

Operating System	Microsoft Windows 7 Professional SP1 64-bit EN
CPU	Xeon E5-2609v3 1.90GHz 15MB cache
RAM	32 GB DDR4
Hard disk	1.5 TB
Optical drive	DVD-RW
Display	96 dpi
Graphics	SXGA (1280×1024, True color)
Input devices	Keyboard, mouse
Ports	2xDouble CameraLink port; 1 FireWire (1394 A); 4 × USB 2.0; GB Ethernet

Appendix – Packaging instructions

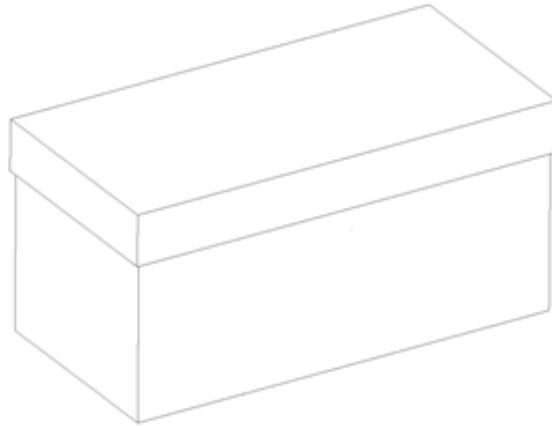

Figure 1.

Preparations

1. Unload the slide from the device by using the scanner software. Remove your slide.
2. Close the scanner software normally.
3. Turn off the scanner with the main switch located on the backside of the device. Disconnect all the cables of the scanner.
4. Remove the main camera and camera adapter.
5. Turn off and disconnect all the cables of the workstation and display.

Main parts and their accessories

1. BOX 1 – Big carton box
 - a) fixing foams for the angles of the scanner box
2. BOX 2 – SCAN II scanner – large carton box
 - a) Scanner unit
 - b) objective(s)

3. BOX 3 – carton box dedicated for the PC
 - a) PC (placed inside the dedicated foam)
 - b) power cable for PC
 - c) power cable for scanner
 - d) USB cable of the scanner
 - e) keyboard and mouse (has a separated small carton box)
 - f) 3DH mouse pad

4. BOX 4 – Accessories (3 pcs)
 - a) main camera
 - b) power supply + connector
 - c) power supply cable
 - d) camera adapter(s)
 - e) 10' wrench
 - f) objective spacer set
 - g) magazines for SCAN 150/P250
 - h) dongles, software and driver disks in 3DH SW box
 - i) slide checker
 - j) filter cubes (if any)

5. BOX 5 – Cables
 - a) 3 m USB cable
 - b) USB cable of the scanner
 - c) trigger cable
 - d) camera protector

6. BOX 6 – FL lamp (if any)
 - a) FL lamp
 - b) lamp power supply
 - c) power supply cable
 - d) adapter
 - e) light guide

Packaging

The whole system is packed in a big carton box. This is divided into two areas with a vertical carton slab:

“Space 1” for accessories (PC, cables, etc.)

“Space 2” for BOX 2 (scanner)



Figure 2.

1. BOX 2 – scanner box
2. Fixing foams for underneath BOX 2
3. Fixing foams for above BOX 2
4. Bottom part of BOX 1
5. Top of BOX 1
6. BOX 3
7. BOX 4, 5, 6

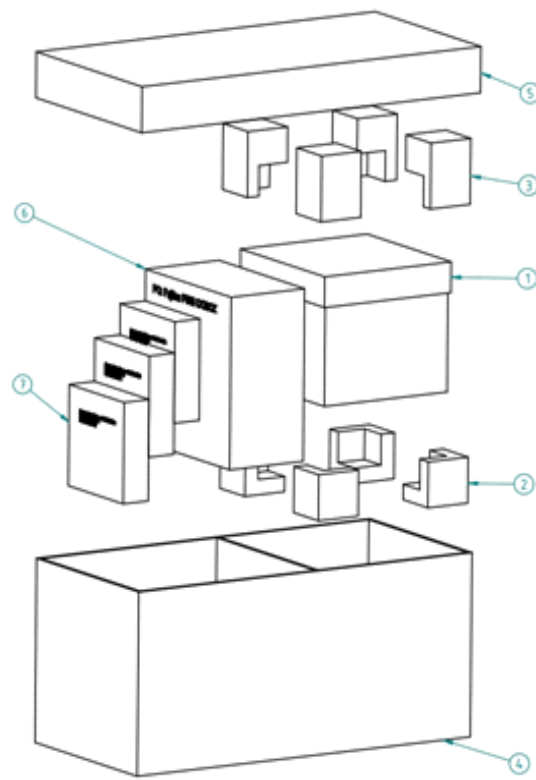

Figure 3.

Packing the SCAN II scanner

The most sensitive and most heavy unit is the SCAN II scanner. Please handle it with care, the weight of the device is more than 29 kg.

Place the scanner to the nylon bag.

The structure of the BOX 2 including the rubber foams is shown on Figure 4. The shape of the foam in the box defines the orientation how the scanner should be placed inside, so first please examine it!

The scanner should be lifted up by holding the scanner at its motherboard between its feet and taken inside the BOX 2's lower part onto the foams inside it.

The shape of the rubber foam defines the orientation, how they should put on. After the scanner and foams are taken in, you can place the upper part of the box of the scanner. Now place the BOX 2 into BOX 1 and place the fixing foams around.

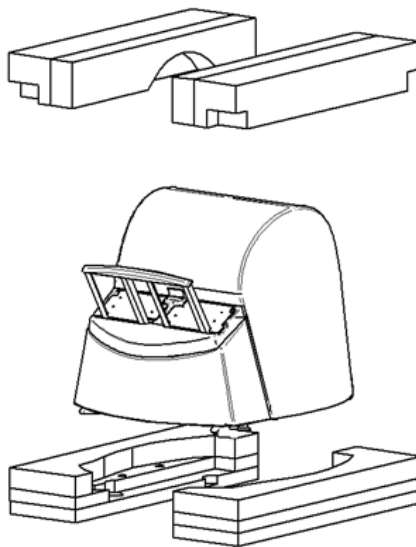

Figure 4.

Packing the accessories

Place inside BOX 1 all the accessories of the scanner. BOX 3, 4, 5 and BOX 6 should be next to each other. Fill the gaps with pellets.

Closing the package

Place the top to BOX 1. Secure it with strap.

Handling of the package

Please be aware to observe the following instructions on **Figure 5.**:





Designation	Symbol	Explanation
Top		The package must always be transported, handled and stored in such a way that the arrows always point upwards. Rolling, swinging, severe tipping or tumbling or other such handling must be avoided. The cargo need not, however, be stored "on top".
Fragile, Handle with care		The symbol should be applied to easily broken cargoes. Cargoes marked with this symbol should be handled carefully and should never be tipped over or slung.
Keep dry		Cargoes bearing this symbol must be protected from excessive humidity and must accordingly be stored under cover. If particularly large or bulky packages cannot be stored in warehouses or sheds, they must be carefully covered with tarpaulins.
Recycling		This indicates that an object is capable of being recycled.
CE		The symbol shows that the device complies with the essential requirements of the relevant European health, safety and environmental protection legislation, in practice by many of the so-called Product Directives..
Fragile, keep dry	FRAGILE KEEP DRY	The symbol should be applied to easily broken cargoes. Cargoes marked with this symbol should be handled carefully and should never be tipped over or slung. Cargoes bearing this symbol must be protected from excessive humidity and must accordingly be stored under cover. If particularly large or bulky packages cannot be stored in warehouses or sheds, they must be carefully covered with tarpaulins.



Figure 5.

Index

B

Barcode.....20, 27, 28, 29, 37, 106, 107
 Brightfield.....13, 19, 112, 115

C

CaseCenter.....20, 37
 Compensation image.....112, 115
 Control software.....20, 106, 119, 122, 125

F

Fluorescent.....13, 18, 19, 20, 24, 27, 115, 116, 121, 125, 130
 Focus.....14, 20, 106, 115, 116, 120, 121

L

Lumencor.....19, 24, 117, 121
 Lumencor Spectra 6 Light Engine.....13, 20, 132

M

Marker.....115

P

Pannoramic.....8
 Pannoramic SCAN II.....8, 9, 10, 11, 13, 14, 15, 17, 18, 19, 20, 22, 24, 29, 119, 122, 128, 129
 Pannoramic Viewer.....20, 120
 Pco.edge.....14, 132
 Preview.....23, 27

S

Scan.....13, 14, 30, 105, 112, 115, 116, 120, 123, 132
 Scanner.....8, 112

*