

Mabtech IRIS™ 2

FluoroSpot/ELISpot/FociSpot reader

Table of Contents

Introduction.....	3
Intended use	3
Symbols	3
Labels	3
Contact information	3
Regulatory information.....	4
Quality Management System (QMS)	5
Safety.....	6
Product description	8
Overview	8
In this package	8
Cleaning/Decontamination.....	9
Disposal.....	9
Warranty.....	9
Technical specifications.....	10
Setup and installation	12
How to use the Mabtech IRIS™ 2 reader	14
Service, maintenance, and transport	16
To replace the fuses.....	17

Introduction





Intended use

Mabtech IRIS™ 2: Detection of secreting cells in ELISpot and FluoroSpot assay. Detection of virus-infected cells (foci) in FociSpot assays.

For research use only.

Symbols

These symbols are shown on the reader:

Symbols	Description
	Complies with the directives listed under "Regulatory information"
	Serial number
 	Electronic waste, disposal according to WEEE
	Warning! The operating instructions must be consulted in all cases where this symbol is marked.





Contact information

Mabtech AB
Augustendalstorget 9
SE-131 52 Nacka Strand
Sweden

Labels

Machine label:

Mabtech IRIS™ 2
FluoroSpot/ELISpot/FociSpot reader
P/N: 2000
100-240 VAC, 50-60 Hz, 1 A max, 100 W
Fuse: F4A H, 250 VAC, 5x20 mm
Inputs: USB 2.0/3.0 and 1000BASE-T
2023-XX-XX Made in Sweden
S/N: #XX
Revision: XXX
Box 1233, SE-131 28
Nacka Strand, SWEDEN
www.mabtech.com

Customer service:
Phone: +46 8 716 27 00
E-mail: mabtech@mabtech.com

Regulatory information

The Mabtech IRIS™ 2 FluoroSpot/ELISpot/FociSpot reader complies with the following directives:

Directive	Applied standards
CE mark for the European Economic Area (EEA)	
2014/30/EU – Electromagnetic Compatibility Directive (EMC)	<ul style="list-style-type: none"> • EN IEC 61326-1, edition 4:2021-06-04 & edition 3:2013-01-11 • EN IEC 61326-2-6, edition 3:2021-06-04 & edition 2:2013-05-03 • EN 55011, edition 5:2016-04-01 +A1:2017-04-21+A11:2020-03-06+A2:2021-04-09 • EN IEC 61000-3-2, edition 5:2019-03-01+A1:2021-04-09 & edition 4:2014-08-22 • EN 61000-3-3, edition 3:2013-08-23+A1:2019-08-02+A2:2021-11-05
2014/35/EU – Low Voltage Directive (LVD)	<ul style="list-style-type: none"> • EN 61010-1, edition 3:2010-10-15+ A1:2019-02-22 • EN 61010-2-101, edition 2:2017-02-24 <i>Safety test according to particular requirements for in vitro diagnostic (IVD) medical equipment.</i> • EN 62471, edition 1:2008-09-12
2011/65/EU – Restriction of Hazardous Substances Directive (RoHS)	<ul style="list-style-type: none"> • CENELEC EN IEC 63000, edition 1:2018-12-07
2006/42/EC – Machinery Directive (MD)	
North America	
FCC Part 2	<ul style="list-style-type: none"> • §§2.906 SDoC:2019-10-01
FCC Part 15*	<ul style="list-style-type: none"> • §15.107:2019-10-01 • §15.109:2019-10-01
ICES-003	<ul style="list-style-type: none"> • Issue 7:2020-10-15
International Standards	
EMC	<ul style="list-style-type: none"> • IEC 61326-1, edition 3:2020-10-26 & edition 2:2012-07-10 • IEC 61326-2-6, edition 3:2020-10-27 & edition 2:2012-07-10 • CISPR 11, edition 6:2015-06-09+A1:2016-06-23+A2:2019-01-18 • IEC 61000-3-2, edition 5:2018-01-26+A1:2020-07-14 & edition 4:2014-05-26 • IEC 61000-3-3, edition 3:2013-05-14+A1:2017-05-18+A2:2021-03-25
Safety	<ul style="list-style-type: none"> • IEC 61010-1, edition 3:2010-06-10+A1:2016-12-16 • IEC 61010-2-101, edition 2:2015-01-23 • IEC 62471, edition 1:2006-07-26

*This equipment has been tested and found to comply with the limits for a Class B digital device, pursuant to part 15 of the FCC Rules. These limits are designed to provide reasonable protection against harmful interference in a residential installation. This equipment generates, uses, and can radiate radio frequency energy and, if not installed and used in accordance with the instructions, may cause harmful interference to radio communications. However, there is no guarantee that interference will not occur in a particular installation. If this equipment does cause harmful interference to radio or television reception, which can be determined by turning the equipment off and on, the user is encouraged to try to correct the interference by one or more of the following measures:



- Reorient or relocate the receiving antenna.
- Increase the separation between the equipment and the receiver.
- Connect the equipment into an outlet on a circuit different from that to which the receiver is connected.
- Consult the dealer or an experienced radio/TV technician for help.

Quality Management System (QMS)

Standard	Description
EN ISO 13485:2016, Edition 4:2016-03-02 +A11:2021-09-08	<ul style="list-style-type: none"> • Medical devices - Quality management systems - Requirements for regulatory purposes
EN ISO 9001:2015, Edition 5:2015-09-15	<ul style="list-style-type: none"> • Quality management systems – Requirements

Safety

Before you install or operate the system, you must read the safety information. There is a risk of user injury or damage to the system if the instructions in this manual are not followed.

	Warning! Risk of personal injury if instructions are not followed.
	Caution! Risk of material damage if instructions are not followed.
	Note: General information or advice on optimal use of the system.



Warning! The Mabtech IRIS™ 2 FluoroSpot/ELISpot/FociSpot reader must only be used by trained persons.



Warning! Do not remove the cover of the reader. Injury to eyes from UV light can result. All internal service and maintenance work must be done by an approved technician. Contact Mabtech for more information.



Warning! Do not keep or use flammable or non-flammable liquids near the system. Risk of fire.



Warning! Use caution when you eject the plate holder. The plate holder protrudes 12 cm from the machine when fully ejected. Risk of physical injury.



Warning! Do not look inside the machine during reading. Risk of injury to eyes from UV light.



Warning! Follow the instructions in this manual when you lift or move the reader. Risk of injury to the persons or damage to the system.



Warning! The instrument may not be used together with biohazardous substances.



Warning! Do not use the instrument near sources of strong electromagnetic radiation (e.g. unshielded intentional RF sources), as these can interfere with the operation of the instrument.



Warning! Do not connect faulty equipment to the system. Risk of electrical shock and damage to the system.



Warning! Connect all cables correctly when you install the system. Risk of electrical shock.



Warning! To disconnect power, unplug either end of the power cable. Place the reader so that the plug can be easily separated from the wall socket.



Caution! Only use the microtiter or cell culture plate types specified under “Technical specifications.” Other plates can cause malfunction and electrical failure.



Caution! Do not insert microtiter or cell culture plates that contain liquid. Risk of short circuit in the reader.



Caution! Do not place objects near or on the reader. Vibrations from the reader can make objects fall.

Product description

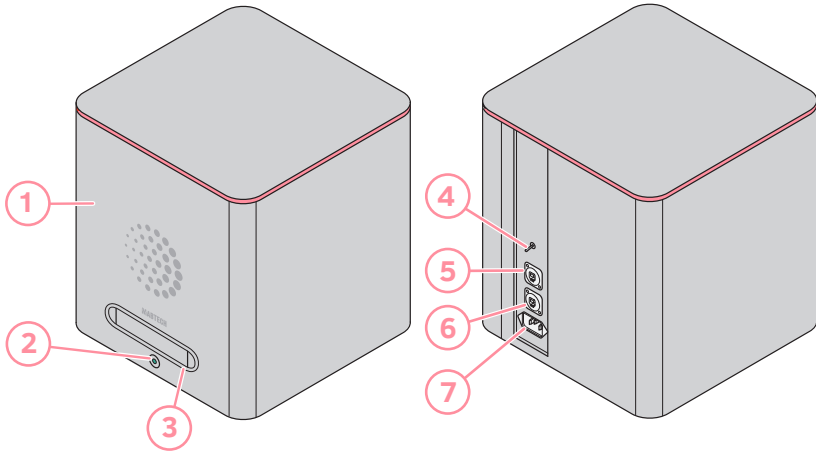

Overview

Number	Description	Number	Description
1	Cover	5	USB port
2	Power button	6	Ethernet port
3	Door to plate loader	7	IEC inlet with fuse holder
4	Programming switch*		

*Programming switch should be set downwards

In this package

The following parts are included in the package:

- Mabtech IRIS™ 2 FluoroSpot/ELISpot/FociSpot reader
- USB cable
- Ethernet cable
- Power cable
- Spare fuse
- Operating Instructions (this manual)
- MAIPSWU adapter
- FociSpot insert

Cleaning/Decontamination

Clean the outside of the Mabtech IRIS™ 2 FluoroSpot/ELISpot/FociSpot reader with a damp cloth when needed.

Before you send the system to any third party, fill out a certificate of decontamination to ensure that the instrument does not contain any potential contaminants.



Warning! The instrument may not be used with biohazardous substances.

Please note that Mabtech cannot accept any instrument or parts that may be contaminated with biohazardous substances such as viable biological agents, harmful quantities of chemicals, or radioactive materials.



Note: FociSpot users need to provide Mabtech with a certificate of decontamination before scheduled service visits. Viral agents that pose risks or threats to the health of service technicians must be declared. Mabtech will not perform service on instruments or parts that may be contaminated.

Disposal



By the end of the reader life, recycle at a designated local reception point for Waste Electrical and Electronic Equipment (WEEE). You must not discard the reader as household waste.

Warranty

Refer to the Mabtech General Terms & Conditions of Sale found on <http://www.mabtech.com/terms-and-conditions> or the contractual agreement between the seller and the buyer.



Caution! Failure to obey the instructions in this manual will void the warranty.



Caution! The safety of any system or equipment that incorporates the Mabtech IRIS™ 2 FluoroSpot/ELISpot/FociSpot reader is the responsibility of the person connecting the reader to that system or equipment.

Technical specifications

Power supply

AC input voltage	100 to 240 VAC
AC input current	Max 1 A @100–240 VAC
AC frequency	50 to 60 Hz
DC input voltage	5 VDC, 0.5 A max
Power consumption	100 W max
Fuses	Quick-Acting F4A H, 250 VAC (H = High Breaking Capacity (Ceramic Tube))

Operation and Maintenance

Interfaces	1 RJ45 port LAN 1000BASE-T
	USB 3.0
Dimensions (H × W × D)	505 mm × 430 mm × 480 mm
Weight	28.6 kg
Environmental specifications	For indoor use only, +5°C to +40°C (+41°F to +104°F) Altitude up to 2000 m Relative humidity range: 5–95% Pollution Degree 2
Mains supply tolerance (%) or absolute mains supply values (voltage fluctuations of the nominal voltage)	+/-10%
Transient overvoltages	Overvoltage Category II Surge Level 3 (CM 12 ohm) & 4 (DM 2 ohm): 2 kV- 1.2/50 µs
IP class	IP20

Key features

Read/calculation speed	ELISpot < 2 min/plate FociSpot < 2 min/plate FluoroSpot 1 color < 5 min/plate FluoroSpot 2 colors < 7 min/plate FluoroSpot 3 colors < 10 min/plate FluoroSpot 4 colors < 13 min/plate
Resolution (H × W)	2048 × 2048 pixels

<p>Approved 96-well plate types</p>	<p>Confirmed but not limited to: ELISpot/FluoroSpot</p> <ul style="list-style-type: none"> • MSIPS45 (ELISpot, clear) • MSIPS4W (ELISpot, white) • M8IPS4510 (ELISpot, strip) • IPFL (FluoroSpot) • MAIPSWU10 (ELISpot, white, w/o underdrain) • MAIPS4510 (ELISpot, clear, w/o underdrain) <p>Cell culture plates for e.g., FociSpot</p> <ul style="list-style-type: none"> • Corning/Costar 3300, 3585, 3595, 3596, 3598, 3599, 3628, 3997 (clear) • Corning/Costar 3917, 3922 (white) • Nunc 167008 (clear)
--	---

The Mabtech IRIS™ 2 FluoroSpot/ELISpot/FociSpot reader must be connected to a computer equipped with the Mabtech Apex™ -software.

Setup and installation



Warning! Follow the instructions in this manual when you lift or move the reader. Risk of injury to person or damage to the system.



Warning! Do not use or keep flammable liquids near the system. Risk of fire.



Caution! The reader is heavy. Place it on a solid table. Use two people to lift or move the reader.



Caution! Keep other equipment more than 10 cm away from the reader. Risk of malfunction caused by overheating.



Note: Keep the packaging in case the system needs to be sent back to Mabtech for service.

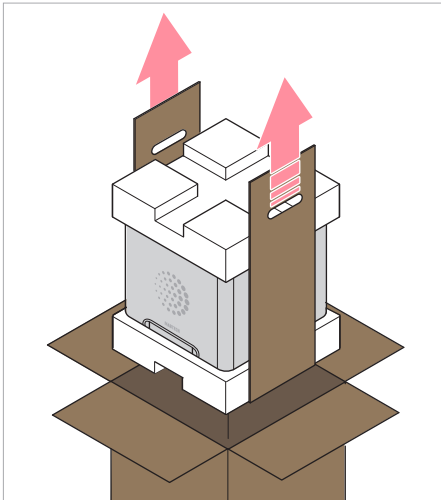

1. Lift the Mabtech IRIS™ 2 reader out of the box by the handles.

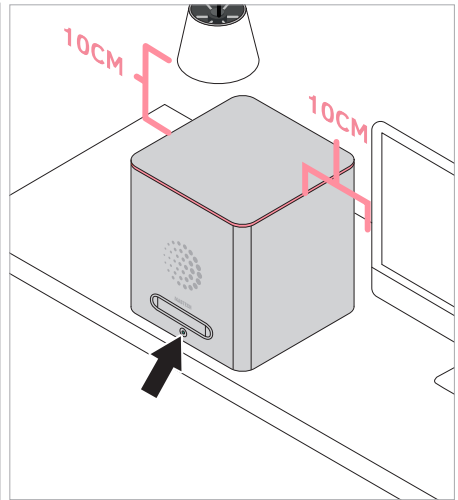

2. Place the Mabtech IRIS™ 2 reader upright on a solid table. Remove the inner packaging. Make sure that you have received all components specified in the section “In this package” on page 8.

3. Connect the USB, Ethernet, and power cables

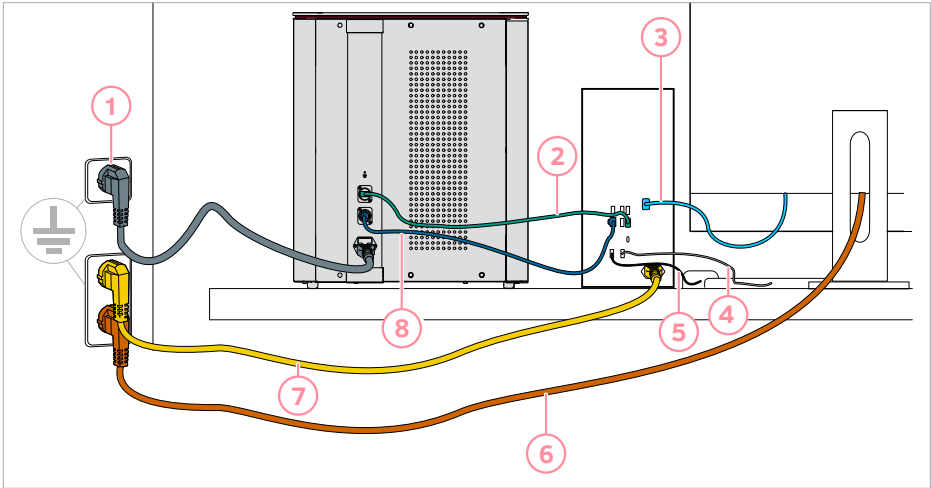

Number	Description	Number	Description
1	Power cord IRIS	5	Mouse cord
2	USB cord	6	Power cord monitor
3	Display port cable (marked D)	7	Power cord computer
4	Keyboard cord	8	Ethernet cable



Warning! Do not connect faulty equipment to the system. Risk of electrical shock and damage to the system.



Caution! Connect the Mabtech IRIS™ 2 FluoroSpot/ELISpot/FociSpot reader to a grounded outlet. The input voltage must be between 100-240 VAC, 50-60 Hz.



Note: In the event of power failure, the reader might have to be re-started.

4. Push the power button to turn on the Mabtech IRIS™ 2 reader.

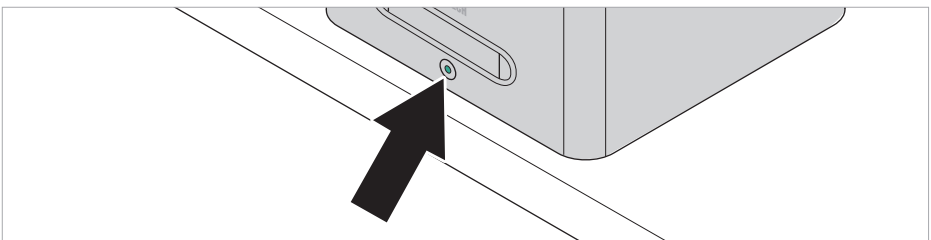

How to use the Mabtech IRIS™ 2 reader

1. Start the computer and double-click on the program symbol. The login screen is shown.
2. Select a profile and enter your password. Click **Login**.



3. Double-click on the type of assay you wish to run.

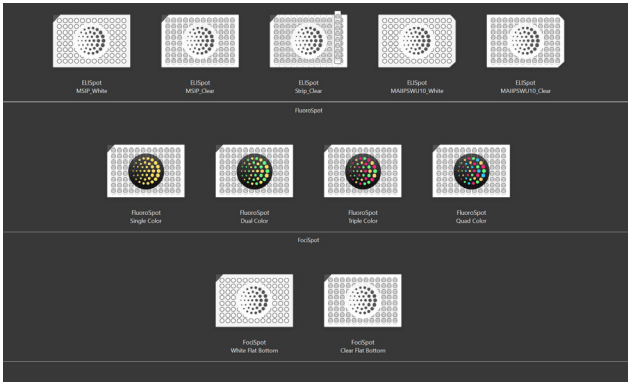

4. Click **Eject**. The reader ejects the plate loader.

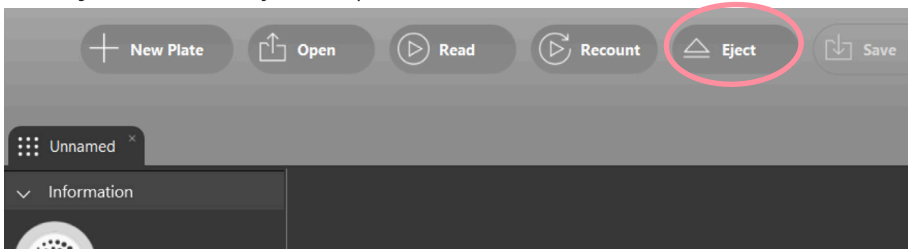

5. Put the microtiter plate or cell culture plate in the plate loader.

6. In Mabtech Apex™, click **Read**. The reader retracts the plate loader. The microtiter plate or cell culture plate is read and the spots are counted.

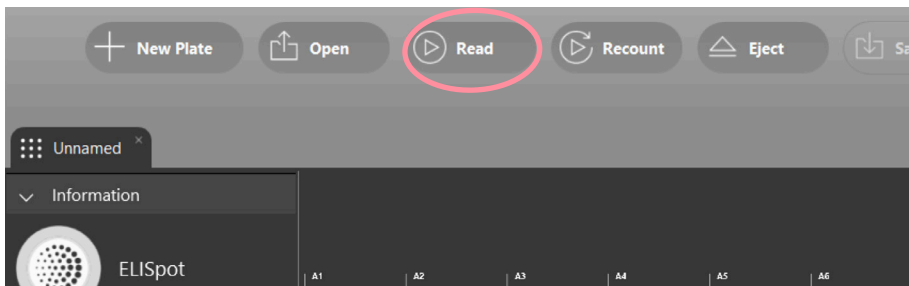

7. Click **Save** and select a folder. Click **Save**.

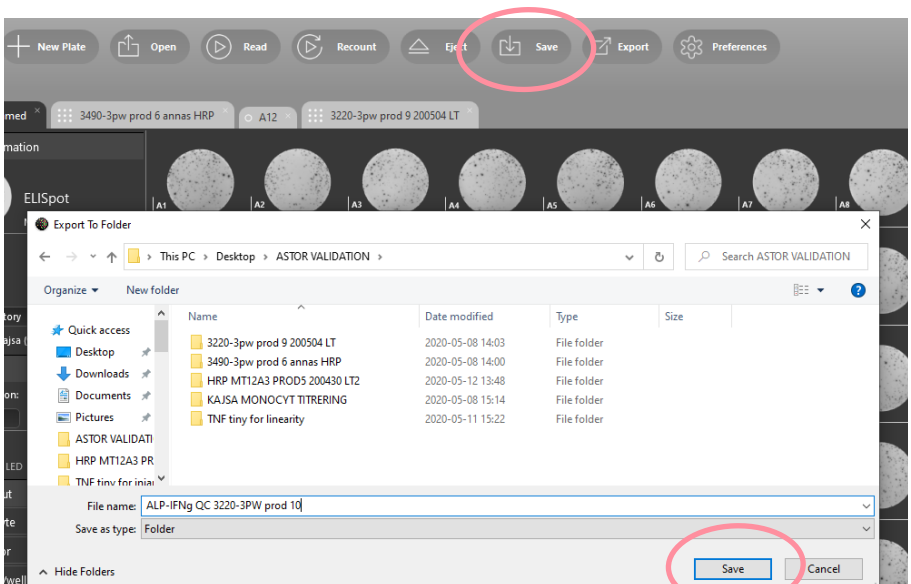

Service, maintenance, and transport



Warning! Do not remove the cover of the reader. Injury to eyes from UV light can occur. All internal service and maintenance work must be done by a technician approved by Mabtech. Contact Mabtech for more information.



Caution! Only use shielded signal cables that are shorter than 3 m to comply with applicable EMC requirements. If the USB cable is longer than 2 m, the connection between the reader and the computer can stop working.



Caution! Use only the parts specified below. Using other parts will void the warranty.

Return the equipment in the same box that it arrived in for repair/service/transport. Environmental conditions for transport and storage should be according to IEC 60068-2 and IEC 60721- 3:

- Public transportation: -40 to +70°C
- Storage locations: -25 to +55°C

Only the following parts can be replaced by the user:

Part	Description
Power cable	<ul style="list-style-type: none">• 240 V/10 A (international) or 100 V/15 A (North America)• IEC 60320-1 C13 connector
Ethernet cable	<ul style="list-style-type: none">• Shielded Ethernet cable (SFTP or STP)• Cat. 5e or 6A• RJ45 male – RJ45 male• ≤ 3 m
USB cable	<ul style="list-style-type: none">• Shielded USB cable• Type A 3.0 male - type B 3.0 male• ≤ 2m
Fuses x 2	<ul style="list-style-type: none">• Cartridge fuses SP 5×20• 250V 4A• IEC 60127-2• Quick-Acting F, H (H = High Breaking Capacity (Ceramic Tube))



Note: All components in Mabtech IRIS™ are compliant with RoHS(Restriction of Hazardous Substances Directive, 2011/65/EU).

To replace the fuses



Warning! Disconnect the power before replacing the fuses. Risk of electrical shock.

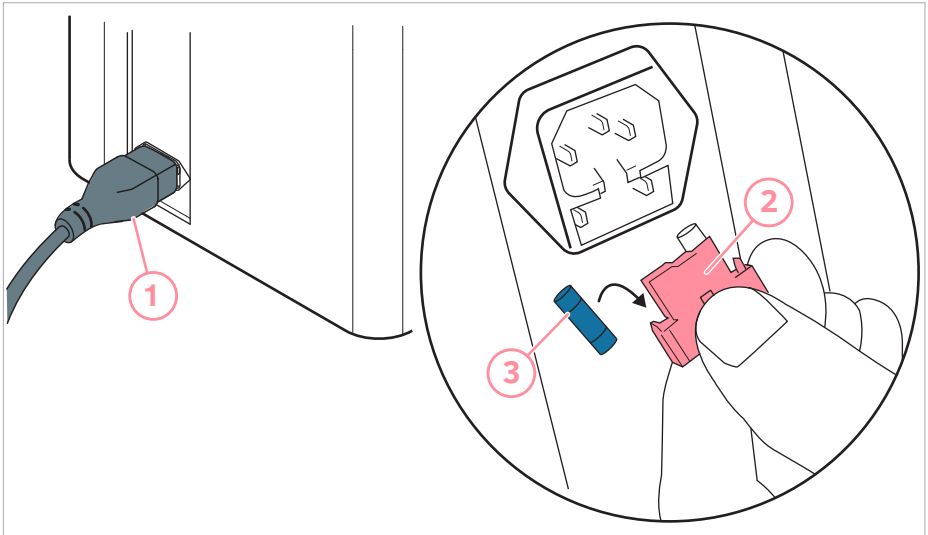

1. Pull out the power cable from the IEC inlet.
2. Remove the fuse holder from the IEC inlet with a flat screwdriver or similar tool.
3. Replace the fuses.
4. Plug the fuse holder and the power cable back in.

Developed and manufactured by MABTECH AB, Sweden, whose quality management system complies with the standards ISO 9001:2015 & ISO 13485:2016.



The products are for research use only.

MABTECH shall not be liable for the use or handling of the product or for consequential, special, indirect or incidental damages there from.

Mabtech AB (Head Office)
Sweden
Tel: +46 8 716 27 00
mabtech@mabtech.com

Mabtech, Inc.
USA
Tel: +1 513 871-4500
mabtech.usa@mabtech.com