

# AVANCE

- Site Planning for AVANCE Systems 850 MHz  
User Manual  
Version 008



Copyright © by Bruker Corporation

All rights reserved. No part of this publication may be reproduced, stored in a retrieval system, or transmitted, in any form, or by any means without the prior consent of the publisher. Product names used are trademarks or registered trademarks of their respective holders.

© November 17, 2016 Bruker Corporation

Document Number: 1000055451

P/N: H157657

---

# Contents

<b>1</b>	<b>Introduction</b> .....	<b>7</b>
1.1	Units Used Within This Manual.....	7
<b>2</b>	<b>Safety</b> .....	<b>9</b>
2.1	Transport and Rigging Safety.....	9
2.2	The Magnetic Field.....	9
2.2.1	Exclusion Zone.....	10
2.2.2	Security Zone.....	10
2.2.3	The 0.5 mT (5 Gauss) Line.....	11
2.2.4	Standards on Health and Safety in the Workplace.....	12
2.3	Ventilation.....	14
2.3.1	Regular Ventilation.....	14
2.3.2	Emergency Ventilation.....	14
2.3.3	Oxygen Level Sensors.....	15
2.4	Safe Handling of Cryogenic Substances.....	15
2.4.1	What is a Quench.....	15
2.4.2	Liquid Nitrogen Refills.....	16
2.4.3	Liquid Helium Refills.....	16
2.5	Earthquake Safety.....	17
2.6	Country-Specific Safety Regulations.....	17
2.7	Emergency Planning.....	17
2.7.1	Fire Department Notification.....	17
<b>3</b>	<b>System Components</b> .....	<b>19</b>
3.1	Superconducting Magnet Components.....	19
3.2	Console and Other System Components.....	20
3.3	CryoProbe System (Optional).....	21
3.4	Other Optional Components.....	22
<b>4</b>	<b>Magnet Access and Rigging</b> .....	<b>23</b>
4.1	Considerations for Off-loading on Site.....	23
4.2	Considerations for Transport to the NMR laboratory.....	24
4.3	Transport Dimensions and Weights.....	24
4.3.1	Magnet Transport Dimensions and Weights.....	24
4.3.2	Spectrometer and Accessories Transport Dimensions and Weights.....	25
4.4	Rigging Equipment.....	26
<b>5</b>	<b>Ceiling Height Requirements</b> .....	<b>27</b>
5.1	Helium Transfer Line.....	28
5.2	Minimum Ceiling Height.....	28
<b>6</b>	<b>Magnetic Stray Fields</b> .....	<b>29</b>
6.1	Horizontal and Vertical Stray Fields.....	29
6.2	Stray Field Plots.....	30
<b>7</b>	<b>Environment and Site Survey Measurement</b> .....	<b>31</b>
7.1	Vibrations.....	31

7.1.1	General Vibration Guidelines .....	31
7.1.2	Measuring Floor Vibrations .....	33
7.1.3	Floor Vibration Guidelines: Bruker API Damping System .....	33
7.2	Magnetic Environment .....	34
7.2.1	Guidelines for Static Objects .....	34
7.2.2	Guidelines for Moving Objects .....	35
7.3	Electromagnetic Interference .....	35
7.3.1	Types of EMF Interference .....	35
7.3.2	DC EMF Interference .....	36
7.3.2.1	Measuring DC Fluctuating Fields .....	36
7.3.2.2	Guidelines for DC Interference .....	36
7.3.2.3	Reducing DC Interference .....	37
7.3.3	AC EMF Interference .....	37
7.3.3.1	Measuring AC EMF Interferences .....	37
7.3.3.2	Guidelines for AC EMF Interference .....	38
7.3.3.3	Reducing AC EMF Interference .....	38
7.3.4	HF Interference .....	39
7.3.4.1	Most Commonly Studied Nuclei .....	39
7.3.4.2	Measuring HF Fluctuating Fields .....	39
7.3.4.3	Guidelines for HF Interference .....	39
7.3.4.4	Reducing HF Interference .....	39
<b>8</b>	<b>Utility Requirements .....</b>	<b>41</b>
8.1	Electrical Power Requirements .....	41
8.2	Telecommunication .....	43
8.3	Compressed Gas .....	43
8.3.1	General Requirements .....	43
8.3.2	Gas Supply .....	43
8.3.3	Other Specifications .....	44
8.3.4	Compressed Air System .....	45
8.3.4.1	Air Compressors .....	46
8.3.4.2	Dryers .....	47
8.3.4.3	Filters .....	48
8.4	Liquid Nitrogen Requirements .....	48
8.5	Cooling Water .....	48
8.6	Lighting .....	49
8.7	HVAC (Heating Ventilation Air Conditioning) .....	49
8.7.1	Heat Dissipation into the Room .....	50
8.7.2	System Stability .....	50
8.8	Emergency Ventilation During Installation and Quenches .....	51
8.8.1	Emergency Exhaust Solutions .....	52
8.9	Fire Detection System and Fire Extinguishers .....	53
<b>9</b>	<b>Floor Plan .....</b>	<b>55</b>
9.1	Magnet Location .....	55
9.2	Dimensions and Mass of Equipment .....	56
9.3	Floor Load .....	56
9.4	Magnet Slab .....	57

9.5	Floor Types .....	57
9.6	Magnet Pits .....	58
9.7	Magnet Platform.....	58
9.8	Magnet Pump Line .....	58
9.9	Maximum Field Strengths for NMR Equipment.....	59
9.10	Cabinet Position .....	59
9.11	Worktable Position .....	60
9.12	Service Access Requirements .....	60
9.13	Layout Examples .....	61
<b>10</b>	<b>CryoProbe and Other Accessories .....</b>	<b>63</b>
10.1	CryoCooling Unit.....	65
10.2	Helium Compressors .....	65
10.2.1	Available Models.....	65
10.2.1.1	Helium Compressor - Indoor Water Cooled .....	66
10.2.1.2	Helium Compressor - Indoor Air Cooled .....	68
10.2.1.3	Helium Compressor - Outdoor Air Cooled .....	68
10.2.2	Space Requirements and Specifications .....	69
10.2.2.1	Indoor Helium Compressors .....	69
10.2.2.2	Outdoor Helium Compressors .....	70
10.3	Helium Cylinders.....	71
10.4	Summary of CryoProbe Options .....	71
10.5	CryoFit .....	73
10.5.1	Introduction .....	73
10.5.2	Installation Requirements .....	73
<b>11</b>	<b>Installation.....</b>	<b>75</b>
11.1	Overview .....	75
11.2	Accessibility .....	75
11.3	Installation Requirements Checklist.....	76
11.4	Installation Procedure .....	76
11.4.1	Magnet Assembly .....	76
11.4.2	Magnet Evacuation and Flushing with Nitrogen Gas .....	76
11.4.3	Cooling the Magnet to Liquid Nitrogen Temperature .....	77
11.4.4	Cooling the Magnet to Liquid Helium Temperatures.....	77
11.4.5	Charging the Magnet .....	77
<b>12</b>	<b>Contact .....</b>	<b>79</b>
	<b>List of Figures .....</b>	<b>81</b>
	<b>List of Tables .....</b>	<b>83</b>
	<b>Index .....</b>	<b>85</b>



# 1 Introduction

This manual contains information about site planning and preparation prior to delivery of a Bruker AVANCE system. The manual should be read through carefully as mistakes made initially may be costly to remedy at a later stage.

The systems covered by this manual are 850 MHz AVANCE spectrometers.

The chapters within this manual deal with various points that need to be considered for successful system operation. They have been included to familiarize you with general principles of successful site planning. For specific questions that may not be addressed in this manual, or for further information on a topic, do not hesitate to contact your local Bruker office. Please also review the Pre-installation Siting Review at the end of the manual.

## 1.1 Units Used Within This Manual

The SI Unit Tesla (mT) is used throughout this manual whenever magnetic field strengths are discussed. Some readers may however be more familiar with the Gauss (G) Unit.

For comparison the conversion fact is: 1 mT=10 G

Likewise the unit kilowatt is used for the measure of heat energy (e.g. amount of heat generated by a device per hour). Some readers may be more familiar with these measurements in BTU/hour:

For comparison the conversion factor is: 1 BTU/hour=0.000293 kW.

(BTU = British Thermal Unit which is the required heat to raise 1 pound of H<sub>2</sub>O by 1 degree Fahrenheit).

Wherever possible both the metric and American (North and South) measure units have been used throughout this manual. In most cases the weights and measures have been rounded upwards where necessary. The following table offers the common metric to American conversion factors used in this manual:

Measure	Metric Units	American Standard Units	Conversion Factor (rounded to nearest hundredth)
<b>Linear</b>	meter (m)	feet (ft.)	1 m = 3.28 ft.
	centimeter (cm)	inch (in.)	1 m = 39.37 in. 1 cm = 0.394 in.
<b>Distance</b>	kilometer (km)	mile (mi.)	1 km = 0.62 mi.
<b>Area</b>	square meter (m <sup>2</sup> )	square foot (ft <sup>2</sup> )	1 m <sup>2</sup> = 10.76 ft <sup>2</sup>
<b>Volume</b>	cubic meter (m <sup>3</sup> )	cubic foot (ft <sup>3</sup> )	1 m <sup>3</sup> = 35.32 ft <sup>3</sup>
	liter (l)	quart (qt.)	1 l = 1.06 qt. (liquid)
<b>Weight</b>	kilogram (kg)	pounds (lbs.)	1 kg. = 2.21 lbs.
<b>Pressure</b>	bar	pounds/square inch (psi)	1 bar = 14.51 psi
		atmosphere (ATM)	1 bar = 0.99 ATM (standard)
<b>Flow</b> (e.g. gas flow)	cubic meter/minute (m <sup>3</sup> /min.)	cubic feet/minute (ft <sup>3</sup> /min.)	1 m <sup>3</sup> /min. = 35.32 ft <sup>3</sup> /min.
<b>Temperature</b>	°C	°F	F = C × 1.8 + 32

Measure	Metric Units	American Standard Units	Conversion Factor (rounded to nearest hundredth)
	°F	°C	$C = (F - 32) / 1.8$
	°C	K	$K = C + 273.15$
	K	°C	$C = K - 273.15$
	°F	K	$K = (F + 459.67) / 1.8$
	K	°F	$F = K \times 1.8 - 459.67$
<b>Magnet Field Strength</b>	Tesla (T)	Gauss (G)	$1 T = 10^4 G$
<b>Heat Energy</b>	BTU/hour	kW	$1 \text{ BTU/hour} = 0.000293 \text{ kW}$
BTU = British Thermal Unit which is the required heat to raise 1 pound of H <sub>2</sub> O by 1 degree Fahrenheit. SI = International System of Units.			

Table 1.1: Metric to American Conversion Factors

## 2 Safety

These safety notes must be read and understood by everyone who comes into contact with superconducting magnet systems. Proper training is required for all people having access to such systems. It is essential that clear information signs are placed and maintained to effectively warn people that they are entering a hazardous area.

Please refer to **Bruker's General Safety Considerations for the Installation and Operation of Superconducting Magnets**, available from Bruker.

### 2.1 Transport and Rigging Safety

---

The following safety notices pertain to the transport and rigging of Avance NMR systems with UHF sub-cooled magnets.

- The magnet should always be transported gently and in an upright position.
- The magnets are sensitive to shocks and tilting, thus are fitted with shock and tilt watches during transportation.
- The magnets should never be lifted from the base, hence no forklifts should be used to lift these magnets.
- Only overhead lifting devices may be used by certified operators at all times; such devices include cranes, trucks with a lifting boom, and hydraulic gantries.
- Air-skates should be used to transport the magnet inside the building.
- Crates should not be left outside; UHF sub-cooled magnets are almost always uncrated outside and then transported inside the building to the NMR laboratory.

### 2.2 The Magnetic Field

---

Since the magnetic field of the magnet system is three dimensional, consideration must be given to floors above and below the magnet, as well as to the surrounding space on the floor the magnet resides on. The magnetic field exerts attractive forces on equipment and objects in its vicinity. These forces, which increase drastically approaching the magnet, may become strong enough to move large equipment and to cause small objects or equipment to become projectiles.

It is important to consider personnel and equipment in the rooms above, below, and adjacent to the room where the magnet will be located:

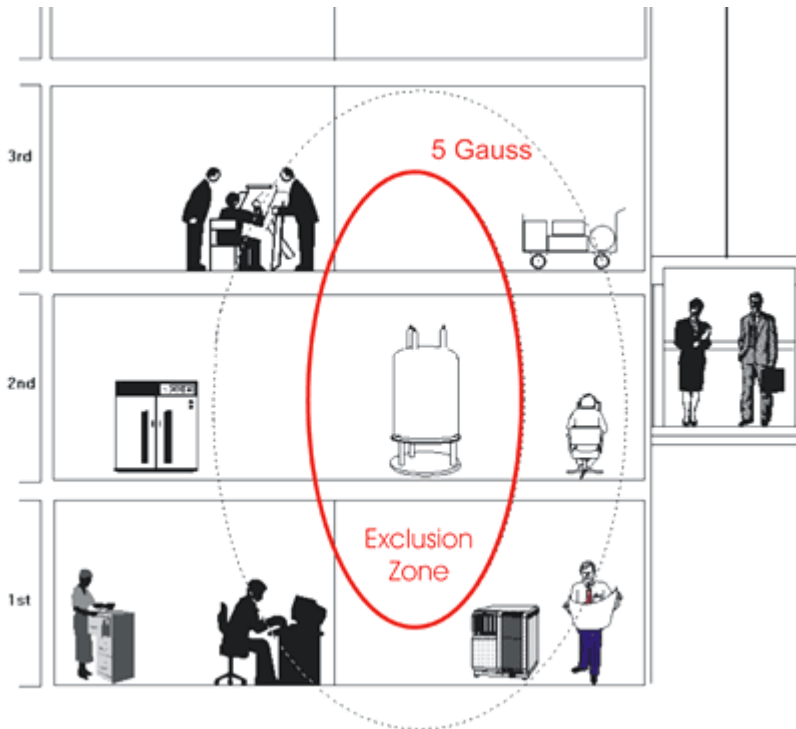

Figure 2.1: Stronger Stray Fields in Vertical Direction than in Horizontal Direction

The magnetic field may affect the operation of electronic **medical implants** such as pacemakers, if exposed to fields greater than 5 Gauss. Medical implants such as aneurysm clips, surgical clips or prostheses may also be attracted. Further care must be taken around changing fields (e.g. pulsed gradient fields). Eddy currents could be generated in the implant resulting in heat generation and/or unwanted torques.

Ensure that all **loose ferromagnetic objects** are outside the 5 Gauss (0.5 mT) field zone of the magnet before the magnet is ramped to field. Human experience and reaction speed are totally inadequate to cope with the extremely nonlinear forces the magnet exerts on iron objects. Therefore no ferromagnetic objects should be allowed to enter the magnet room after the magnet is energized.

## 2.2.1 Exclusion Zone

The **Exclusion Zone** is the area inside the magnet's 5 Gauss (0.5 mT) field line, extended in all directions, including rooms above and below the magnet area.

Individuals with cardiac or other **medically active implants** must be prevented from entering this area. The exclusion zone must be enforced with a combination of warning signs and physical barriers.

## 2.2.2 Security Zone

The **Security Zone** is usually confined to the room that houses the magnet.

**Ferromagnetic objects** should not be allowed inside the security zone to prevent them from becoming projectiles.

### 2.2.3 The 0.5 mT (5 Gauss) Line

---

#### Medical Implants and Pacemakers

A static magnetic field can cause pacemakers and heart defibrillators to switch into **default and reset mode**. The characteristics of default and reset mode can be programmed and are determined by the manufacturer. A physician can initiate a controlled switch into special mode with a strong permanent magnet. He does that to:

- Control pacemaker and heart defibrillator.
- Set a determined frequency for some cycles (independent from the actual need of the body).
- Disable certain functions of the defibrillator.

As soon as the magnet is removed, the pacemaker or heart defibrillator starts working normally again. Newer pacemakers switch into special mode at 1 mT, older models already at 0.5 mT (5 Gauss).

Source: [www.supermagnete.ch](http://www.supermagnete.ch)

#### Pregnant Workers

There are no special guidelines concerning magnetic fields that we are aware of for pregnant workers when compared to all other people.

Pregnant workers are mentioned in Section E of the Annex to the EMF Directive (European Community regulation form, Directive 2013/35/EC), which warns about using cell phones during pregnancy (i.e. warnings about high frequency electromagnetic fields).

We are not aware of other special guidelines for pregnant workers concerning magnetic fields, when compared to other people.

Bruker takes a conservative approach and recommends that all **pregnant workers should stay outside the 0.5 mT (5 Gauss) line**, which is known as a general guideline for public access.

## 2.2.4 Standards on Health and Safety in the Workplace

Guidelines on Limits of Exposure to Static Magnetic Fields are introduced by the ICNIRP (International Commission on Non-Ionizing Radiation Protection). They give separate guidance for occupational exposures and exposure of general public.

### Occupational Exposures

It is recommended that occupational exposure of the head and the trunk should not exceed a spatial peak magnetic flux density of 2 mT (20 Gauss) except for the following circumstance:

For work applications for which exposures above 2 mT (20 Gauss) are deemed necessary, exposure up to 8 mT (80 Gauss) can be permitted if the environment is controlled and appropriate work practices are implemented to control movement-included effects. Sensory effects due to the movement in the field can be avoided by complying with basic restrictions set in the ELF guidelines. When restricted to the limbs, maximum exposures of up to 8 mT (80 Gauss) are acceptable.

### General Public Exposures

Based on scientific knowledge on the direct effects of static fields on humans, acute exposure of the general public should not exceed 400 mT (any part of the body). However, because of potential indirect adverse effects, ICNIRP recognizes that practical policies need to be implemented to prevent inadvertent harmful exposure of people with implanted electronic medical devices and implants containing ferromagnetic materials, and injuries due to flying ferromagnetic objects, and these considerations can lead to much lower restriction levels, such as 0.5 mT (IEC 2002). The exposure limits to be set with regard to these non biological effects are not, however, the duty of ICNIRP.

\* From ICNIRP Guidelines published 2009 (<http://www.icnirp.de/documents/statgdl.pdf>)

### European Community Directive

The European Community did release a **Directive 2004/40/EC** on the minimum health and safety requirements regarding the exposure of workers to the risks arising from physical agents (electromagnetic fields).

This directive, depending on the frequency, specifies the following limits of exposure to electromagnetic fields:

Frequency Range	Magnetic Field Strength H	Magnetic Flux Density B
0...1 Hz	$1.63 \times 10^5$ A/m	0.2 T or 200 mT

This specification and the following more detailed national regulations are an example that fulfills the requirements defined and valid within the EU. Depending on the country where the system is being installed, it is necessary to clarify the country specific or local regulations with respect to exposure and safety in magnetic fields.

*Magnetic field strength* is a vector quantity (H), which, together with the magnetic flux density, specifies a magnetic field at any point in space. It is expressed in Ampere per metre. (A/m).

*Magnetic flux density* is a vector quantity (B), resulting in a force that acts on moving charges, expressed in (T). In free space and in biological materials, magnetic flux density and magnetic field strength can be interchanged using the equivalence  $1 \text{ A/m} = 4\pi \cdot 10^{-7} \text{ T}$ .

### German Regulations

In Germany, regulation BGV B11 describes the maximum exposure doses in two basic tables. Table 2.1 applies to situations under the standard precautionary conditions, whereas Table 2.2 applies to systems with field strengths above 5 Tesla and can only be applied to certain subgroups of people, which meet nonstandard precautionary conditions. Details on the different precautionary conditions and subgroups of people are given in the document BGV B11 document.

Exposure	Maximum Magnetic Flux Density
Average over 8 hours	212 mT
Peak values for head and body	2T
Peak values for extremities	5T
<i>Standards on health and safety in the workplace for standard precautions and users, according to BGV B11.</i>	

Table 2.1: BGV B11 Standards for Standard Precautions and Users

Exposure	Maximum Magnetic Flux Density
Average over 8 hours	4T
Peak values for head and body	2T
Peak values for extremities	10T
<i>Health and safety standard in the workplace applicable under special conditions to selected subgroups of people, according to BGV B11.</i>	

Table 2.2: BGV B11 Standards Under Special Conditions for Selected Subgroups

The next table shows the maximum retention periods within different stray field regions below 5 Tesla for standard precautionary situations. The corresponding spatial regions within and around the super-conducting magnet can be worked out from the stray-field plots of the magnet being used.

Magnetic Flux	Retention Period	Parts of the Body
5T	< 20 Minutes	Extremities
4T	< 25 Minutes	Extremities
3T	< 34 Minutes	Extremities
2T	< 52 Minutes	Head/Body
1T	< 1 Hour 42 Minutes	Head/Body
0.5T	< 3 Hours 23 Minutes	Head/Body
0.3T	< 5 Hours 39 Minutes	Head/Body
<i>We do not take any responsibility for the numbers given in this table!</i>		

Table 2.3: Example of Maximum Retention Periods

If higher field strength is accessible inside the magnet by a user's extremities, a corresponding table for non-standard situations can be worked out from the table above. However, the analysis must be carried out in a more detailed and differentiated manner and a greater number of more important conditions must be strictly fulfilled.

## 2.3 Ventilation

---

Typical NMR superconducting magnets use liquid cryogenics as cooling agents. During normal operation of the magnet system it can be expected that a boil-off will occur:

- A normal boil-off of liquids contained in the magnet will occur based on the established boil-off specifications.
- A boil-off of cryogenics will occur during regular refills.

A very large increase in volume accompanies vaporization of the cryogenic liquids into gas. The cryogenic gas to liquid volume ratios are approximately 740:1 for helium; 680:1 for nitrogen. Due to this large increase in volume the vapor may displace the air in an enclosed room. If someone is in the room, this may lead to **asphyxiation**. To prevent this and other dangers, the following minimum general safety rules concerning ventilation apply:

- Cryogenic liquids, even when kept in insulated storage dewars, remain at a constant temperature by their respective boiling points and will gradually evaporate. These **dewars** must always be allowed to vent or dangerous pressure buildup will occur.
- Cryogenic liquids must be handled and stored in well ventilated areas.
- **Exit doors must open to the outside**, to allow safe exit in the event the room becomes pressurized by helium gas during a magnet quench.
- Room layout, ceiling clearance and magnet height must be such that an easy **transfer of liquid** nitrogen and helium is possible. This will considerably reduce the risk of accidents.

### 2.3.1 Regular Ventilation

---

Regular HVAC systems should be able to handle 3 - 5 room air exchanges per hour, and provide temperature stability of +/- 0.5°C per 24 hours. Please refer to [HVAC \(Heating Ventilation Air Conditioning\) \[▶ 49\]](#) for more details.

### 2.3.2 Emergency Ventilation

---

Depending on the actual size of the magnet room, a large amount of He and/or N<sub>2</sub> gas could displace the air in the room. This is possible during the initial cooling of the magnet, during follow-up cryogen fills, or in case of a quench. Therefore, an emergency exhaust system may be required to avoid asphyxiation. Please refer to the section [Emergency Ventilation During Installation and Quenches \[▶ 51\]](#), for more details.

#### Pits

As discussed in [HVAC \(Heating Ventilation Air Conditioning\) \[▶ 49\]](#), continuous air flow (exhaust) is required within the confines of a magnet pit. A low exhaust down in the pit is recommended. Additional emergency ventilation may also be necessary. Since nitrogen gas cannot be detected by the human senses, an oxygen sensor mounted in the pit will trigger an increased rate of exhaust.

### 2.3.3 Oxygen Level Sensors

---

Oxygen (O<sub>2</sub>) monitors, or level sensors, are required in the magnet room to detect low levels of O<sub>2</sub> due to cryogenic gases. At a minimum the following sensors must be provided:

- One oxygen level sensor must be above the magnet, to detect low oxygen levels caused by high helium gas levels.
- One oxygen level sensor approx. 30 cm off the floor of the magnet room.
- One additional oxygen level sensor approx. 30 cm off the bottom of the pit, in case the magnet is located inside a pit.

These monitors and sensors generally must be located outside the 0.5 mT (5 G) line. Check with original equipment manufacturer for information on the effects of magnet fields on these devices.

Please refer to [Emergency Ventilation During Installation and Quenches \[ 51\]](#) for more information on ventilation and exhaust solutions.

## 2.4 Safe Handling of Cryogenic Substances

---

Superconducting NMR magnets use liquid helium (all magnets) and nitrogen (only non-Aeon magnets) as cooling agents, keeping the magnet core at a very low temperature. The safe handling of cryogenic liquids requires some knowledge of the physical properties of these liquids, common sense, and sufficient understanding to predict the reactions of such liquids under certain physical conditions.

Cryogenic liquids, even when kept in insulated storage vessels (dewars), remain at a constant temperature by their respective boiling temperature. As a result, a fraction of the liquid constantly evaporates into the gas phase, leading to a pressure build-up inside the storage dewar. A very important characteristic of cryogenics is their enormous increase in volume during the conversion from liquid to gaseous phase. This conversion follows a raise in gas temperature starting at the boiling temperatures of the cryogenic liquids and going up towards room temperature.

The gases are nontoxic and completely harmless as long as adequate ventilation is provided to avoid suffocation. During normal operation only a small hourly rate of cryogen is evaporated, but during a quench, an extremely large quantity of helium gas is produced within a short time.

Cryogenic liquids must be handled and stored in **well ventilated areas**. Containers for cryogenic liquids must be constructed with non-magnetic materials and should be specifically designed for use with particular cryogenics. Be sure to read and follow any specific instructions provided by the container manufacturer concerning their individual products.

### 2.4.1 What is a Quench

---

A magnet **quench** is the breakdown of superconductivity in a partially or fully energized magnet. The stored field energy is transformed into heat, leading to a fast evaporation of liquid helium. During a quench, an extremely large quantity of helium gas is produced within a short time.

Although helium gas is inert, if generated in large enough quantities, it can displace the oxygen in the room causing potential danger of suffocation (refer to [Emergency Ventilation During Installation and Quenches \[ 51\]](#)).

## 2.4.2 Liquid Nitrogen Refills

**Keep contact with air at a minimum.** When liquid nitrogen is exposed to air, it can condense and become as hazardous as liquid oxygen. The **pressure relief valve** for the nitrogen vessel should be mounted at all times, even when the vessel is being refilled. Special attention is required for the **transportation of cryogenics by elevator**, no one should be allowed to be in the elevator with a cryogen dewar.

When the vessel is being refilled, liquid nitrogen should not be allowed to spill onto the room temperature bore closure flanges. Place gum rubber or Teflon tubes on the nitrogen neck tubes during refill. The transfer should be stopped immediately when the vessel is full. Failure to observe this can lead to the freezing of the O-rings and a subsequent vacuum loss of the magnet cryostat.

The liquid cryogen transport dewars used to refill the magnet must be of the low pressure type. **Never use high pressure gas-packs.** The dewar must have a fixture for pressurizing and transferring via a stainless steel or corrugated plastic tube (10 mm inner diameter). Where possible the dewar should be self pressuring. The typical transport dewar pressure for transferring liquid nitrogen is 0.10 - 0.20 bar (1-3 psi), the maximum 0.35 bar (5 psi).

The refill procedure is described in detail in the magnet manual. For further information on liquid nitrogen requirements, refer to the chapter [Liquid Nitrogen Requirements \[ 48\]](#).

## 2.4.3 Liquid Helium Refills

Liquid helium is the coldest of all cryogenic liquids, therefore it will condense and solidify any other gas (air) coming in contact with it. The consequent danger is that pipes and vents may become blocked with frozen gas. Vacuum insulated pipes should be used for transferring liquid helium.

Liquid helium must be kept in specially designed storage or transport dewars. A one-way valve is supplied to avoid air or moisture from entering the helium vessel. This is to prevent ice from building and plugging the neck tubes. The 0.2 bar valve must be mounted at all times even during a helium transfer.

Often, permanently installed helium gas lines are used to pressurize the liquid helium transport dewars during the helium refills. Alternatively, helium gas cylinders can be used. The helium gas cylinder should never be brought close to the magnet and should always be kept well outside the 5 Gauss line. The gas cylinder should be secured to a wall or structural column well outside the 5 Gauss line to prevent a dangerous accident. A He gas purity of 4.6 (99.996%) is recommended.

The refill procedure is described in detail in the magnet manual.

### CAUTION

#### **Danger of cold burns or freezing during the transfer of liquid helium.**

During the transfer of liquid helium it is possible that cold burns or freezing may occur.

- ▶ The transfer of liquid helium can be done easily and safely, provided the helium transfer line is in good condition, is handled correctly, and the transfer pressure does not exceed 3.5 psi (0.24 bar).
- ▶ Never connect a warm helium transfer line to the magnet as the warm helium gas could disturb the magnet temperature.
- ▶ Always allow the helium transfer line to cool down to helium temperature before connecting it to the short end inserted into the helium fill port.
- ▶ Adequate protection and clothing is required at all times when handling, transferring, or operating near cryogenic fluids.



## 2.5 Earthquake Safety

---

In regions where there is a potential risk of earthquakes, additional precautions should be taken to reduce the chance of personal injury or property damage through movement or tipping of the magnet.

Many countries or regions have documented regulations, including building codes, regarding earthquakes. Before installing a magnet system, it is highly advisable that you check with local authorities on whether your area is prone to earthquakes and if there are any regulations in effect.

If the installation site is regarded as an earthquake area, please contact Bruker for information on earthquake securing equipment.

## 2.6 Country-Specific Safety Regulations

---

In addition to the above safety precautions, any country-specific safety regulations for operating NMR systems must be fulfilled. These may include, for example, regulations on:

- Facilities of a controlled access area around the magnet
- Working conditions at computer stations
- Use of anesthesia gases
- Handling of laboratory and transgenic animals

## 2.7 Emergency Planning

---

Due to the strong magnetic fields and presence of cryogenics when using NMR systems, it is important to define and communicate what to do in case of problems or an emergency. An **Emergency Plan** can be defined as a documented set of instructions on what to do if something goes wrong. Emergency Plans are often defined as part of the Standard Operating Procedures (SOP), or as a stand-alone document. In any case every NMR laboratory should have an Emergency Plan in effect.

As every organization has its own policies and procedures, as well as varying laboratory layouts, an Emergency Plan should be individually defined by the customer for their laboratory as appropriate. The Emergency Plan is the responsibility of the customer and of the building and facility management.

### 2.7.1 Fire Department Notification

---

It is recommended that the magnet operator introduce the fire department and/or local authorities to the magnet site. It is important that these organizations be informed of the potential risks of the magnet system, e.g. that much of the magnetic rescue equipment (oxygen-cylinders, fire extinguishers, axes etc.) can be hazardous close to the magnet system. In addition, their expertise and experience can be invaluable in creating an Emergency plan.

- In a NMR laboratory use only non-magnetic fire extinguishers.
- Breathing equipment which uses oxygen tanks made out of magnetic material can be life threatening when used close to a magnet system which is energized.
- During a quench helium gas escaping from the system must not be mistaken for smoke. Instruct the fire department and technical service not to „extinguish“ the magnet system with water. The outlet valves could freeze over the quench valves eventually do not close again.
- Laboratory windows which are accessible during an emergency must be clearly marked with warning signs, visible from the outside.



## 3 System Components

This section describes the types and functions of the various sub-systems that are delivered as part of our AVANCE UltraStabilized NMR systems. These include the following:

- [Superconducting Magnet Components](#) [▶ 19].
- [Console and Other System Components](#) [▶ 20].
- [CryoProbe System \(Optional\)](#) [▶ 21].
- [Other Optional Components](#) [▶ 22].

### 3.1 Superconducting Magnet Components

---

The superconducting magnet is a complex system producing a very strong, homogeneous, and stable magnetic field as required for NMR. This section describes the various sub-systems of the magnet system.

<b>Magnet temperature:</b>	The magnet uses both liquid nitrogen and liquid helium. The magnet coil is immersed in liquid helium inside a dedicated helium vessel. Liquid nitrogen fills a different vessel and reduces the helium evaporation rate.
<b>UltraStabilized Magnets:</b>	The magnet coil is immersed in a liquid helium bath at a sub-cooled temperature (~2 K). An additional liquid helium bath operating at a standard temperature of 4.2 K is located above the sub-cooled helium section.
<b>Magnet current:</b>	After the initial charging with electrical current, the magnet runs in persistent mode. The current runs in a closed loop inside the system and the magnet itself is no longer connected to a continuous power supply.
<b>Pump-line</b>	The sub-cooled systems are equipped with a special pump line in order to reduce the liquid helium temperature from 4.2 K to ~2 K. The pump line connects one port of the magnet to a set of pumps. Pumping is done on a Joule-Thompson Cooling Unit located inside the cryostat in order to reduce the temperature of the liquid helium (by using this method the large volumes of liquid and gaseous helium in both temperature zones can be kept slightly above atmospheric pressure).
<b>Maintenance:</b>	Magnet maintenance consists of refilling the system with cryogenic fluids at defined time intervals.

## 3.2 Console and Other System Components

The next table lists the various parts of the console, monitoring & control units. Please also refer to the floor plan diagrams beginning in the chapter [Floor Plan \[ 55\]](#). These scaled diagrams provide an idea of where the various pieces of NMR equipment should be placed.



Figure 3.1: Spectrometer and Magnet Control

1.	The <b>AVANCE console</b> main cabinet, where the actual NMR data acquisition is performed.
2.	The <b>probe</b> , which is designed to hold the sample, transmit radio frequency signals which excite the sample and receive the emitted response. The probe is inserted into the bottom of the magnet and sits inside the room temperature shims. Coaxial cables carry the excitation signals from the console amplifiers to the probe and the NMR signal back from the sample to the receiver.
3.	The <b>HPPR/2</b> amplifies, filters and routes the NMR response signals from the probe to the RX22 receiver. It switches the RF transmitter output to the probe.
4.	The <b>Bruker Magnet Pump Control (BMPC II)</b> , which monitors the magnet status and cryogenic parameters, interfaces between the magnet, pump system, and user. The BMPC II includes the pumps that drive the Joule-Thompson cooling unit in order to maintain the temperature of ~2K.
5.	The <b>BCU-II Unit</b> delivers very cold gas, either nitrogen or dry air, through a flexible isolated non-magnetic transfer line. It is possible to control the sample temperature down to -60°C inside the probe for solid or liquid NMR applications.
6.	The <b>BCU-I Unit</b> cools VT gas to allow proper sample temperature regulation. The unit reduces the temperature of the air input (supplied by the variable-temperature unit) and provides cooling of the NMR sample within the magnet to at least -5 °C for a room temperature of 25 °C.
7.	The <b>workstation</b> acts as the operational computer for the user processing NMR data and sending/receiving data to/from the acquisition computer in the main console.
8.	The <b>Uninterruptible Power Supply (UPS)</b> feeds the BMPC II and provides continuous power in case of power failure. The UPS also acts as a power conditioner. It is recommended to have the UPS on emergency power.
9.	<b>Air compressor</b> (not pictured). The air compressor should have a maximum duty cycle of 50%. When the area where the compressor is located is very humid, air conditioning should be used. If floor vibrations are a problem, insulation should be used.

### 3.3 CryoProbe System (Optional)

The Bruker CryoProbe™ Accessory for the AVANCE NMR spectrometers offers dramatic increases in signal to noise ratio, stability, and ease of use. For site planning details for the CryoProbe accessory, refer to [CryoProbe and Other Accessories \[▶ 63\]](#).

The CryoProbe system consists of the following components:



Figure 3.2: CryoProbe System

1.	The <b>CryoProbe</b> represents the NMR probe inside the magnet bore, and is cooled by cryogenic helium gas. The CryoProbe maximizes efficiency and reduces thermal noise, thus enhancing the signal-to-noise ratio.
2.	The <b>CryoCooling unit</b> contains a cryocooler, a cryocontroller, a vacuum system, and He transfer lines. The unit cools compressed helium gas by expansion and provides and maintains the vacuum insulation. The unit also supervises all CryoProbe operations.
3.	The research grade <b>Helium gas cylinder</b> provides research grade helium gas (99.9999%) at high pressure (min. 200 bar) for flushing the probe prior to a cool-down cycle. The cylinder includes a regulator, an outlet valve, and a charging hose.
4.	A <b>transfer line</b> supports provide support for the probe and isolates the probe against vibrations.
5.	The <b>He compressor</b> provides compressed helium gas to the CryoCooling unit. The compressor connects to the CryoCooling unit by means of helium gas pressure lines. The indoor water-cooled helium compressor is shown to the right. Other models, including indoor air-cooled and outdoor air-cooled, are available.

## 3.4 Other Optional Components

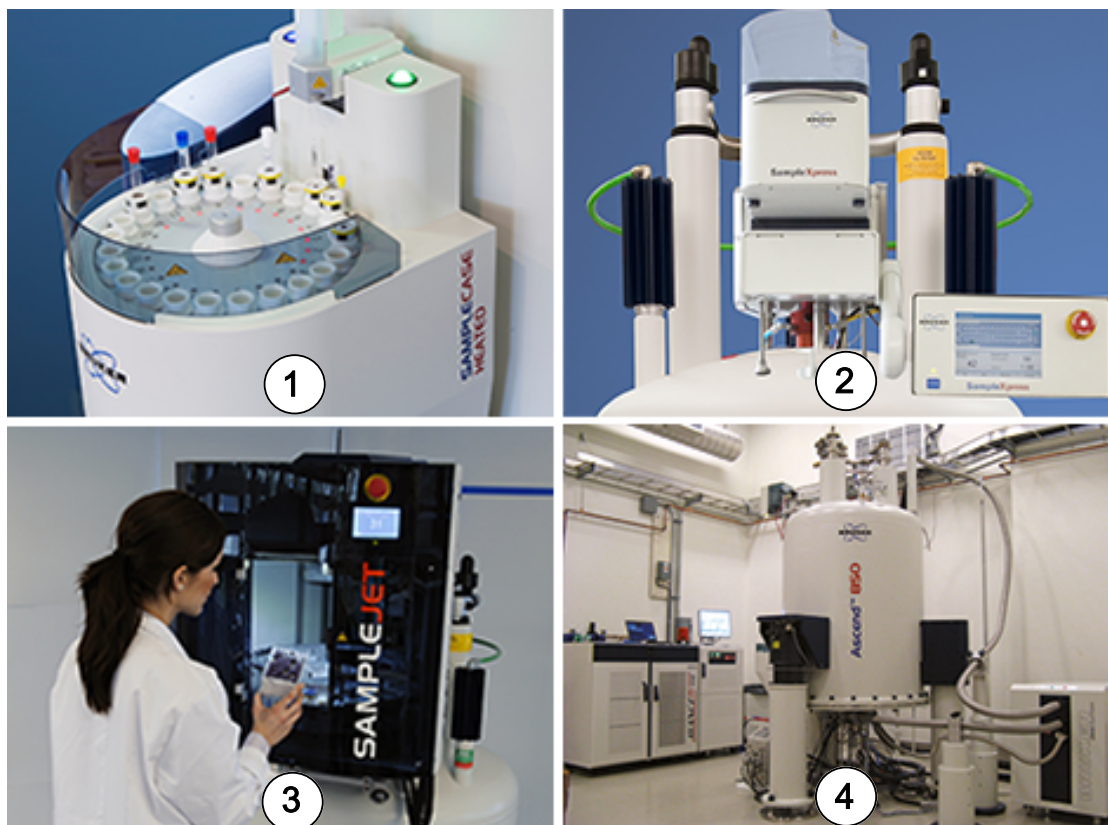

Figure 3.3: Other Options for AVANCE Systems

1	<b>SampleCase</b> is a 24 sample, random-access, automation system that fits almost all shielded Bruker standard bore magnets.
2	<b>SampleXpress</b> allows automatic measurement of NMR samples with Bruker NMR spectrometers. SampleXpress is controlled by TopSpin or IconNMR, and is equipped with integrated barcode reader registration, which is under control of SampleTrack.
3	<b>SampleJet</b> is a robot which has been consciously designed to meet growing demand for simplicity, versatility and higher throughput in NMR sample tube automation.
4	The <b>Bruker Smart Nitrogen Liqueflier (BSNL)</b> is an accessory available for systems with the CryoProbe option, that uses the extra cooling capacity of the latest generation CryoPlatform to re-condense the evaporating nitrogen nitrogen gas from the magnet dewar.

## 4 Magnet Access and Rigging

The magnet is very heavy and fragile, thus requires special consideration during delivery and movement to its final installation point. The other components of the spectrometer system (console, options, etc.) can typically be removed from the trucks with forklifts and are positioned in the NMR lab with a pallet jack. Specifications for these components are also included in this chapter for planning purposes.

### 4.1 Considerations for Off-loading on Site

---

When planning for offloading the magnet and console during delivery, the following factors must be considered:

#### Delivery Area

There must be sufficient space in the driveway or parking area for the overhead crane and for the delivery truck. There must also be sufficient leveled area for uncrating the magnet and other crates.

#### Transport Weight

The transport weight and size of the magnet system, console and their respective crates will affect the choice of equipment required for offloading and movement of the magnet.

#### Loading Dock

The **size and overhead clearance** of the loading dock will influence the choice of crane or other rigging equipment required to off load the magnet and system crates.

The **load bearing capacity** of the loading dock must be sufficient for the system. Refer to the transport weights of the magnet system, console, and accessories listed in the chapter.

#### Equipment Requirements

All rigging equipment required to off-load the magnet system must be selected to handle the size and transport weights of the system.

**Crane:** A crane meeting the load requirements for the specific magnet is required to lift the magnet off the truck, place it on a flat surface for uncrating, and for lifting the magnet again for placement on air skates.

**Forklift and/or Pallet Jack:** These may be used to off load and transport other crates, the temporary stand, and the base plate.

## 4.2 Considerations for Transport to the NMR laboratory

Before delivery the customer must ensure that the system and magnet can be transported to the site. The section on [Transport Dimensions and Weights \[ 24\]](#) in this chapter provides the sizes and weights of the crates in which the system are shipped. The following must be considered:

- The access clearance (height and width) and **floor loading capacity** must be checked along the entire route that the magnet will take from the access point into the building to the laboratory. Please refer to the Transport Dimensions and Transport Weights tables.
- Transport will also be affected by any floor irregularities and the presence of door jams and steps. Use Masonite **leveling sheets** to traverse floor irregularities such as cracks and door seals.
- **Elevator** capacity and dimensions must also be considered if the magnet must make an elevation change within the building.
- The **turning radius** can also be a factor if, for example, corners must be navigated. It is important to make sure the rigging equipment for magnet assembly (e.g. a long I-beam for the gantry) can be brought into the lab.
- The console and magnet must be moved in an **upright position**.

Refer to the section [Rigging Equipment \[ 26\]](#) for more information.

## 4.3 Transport Dimensions and Weights

### 4.3.1 Magnet Transport Dimensions and Weights

The door dimensions for magnet access and the transport weights for each magnet are listed below. For the weights of the rest of NMR equipment, please refer to the dimensions and weights table in the [Floor Plan \[ 55\]](#) chapter.

Magnet Type	Crate Size (m)			Crate Weight (kg)*	Minimum Door Dimensions (m)		
	L	W	H		Width Uncrated	Height Uncrated**	Height if Crane is Used***
Ascend 850	2.2	2.4	2.4	~4,100	1.40	2.40	3.9

\* Approximate transportation weight – crated.

\*\* Absolute minimum height needed for doors and openings (it takes into account min. transport height uncrated plus 150 mm for air-skates).

\*\*\* These numbers are approximate; the true number will depend on the distance between the boom of the crane and the bottom of the magnet.

Table 4.1: Door Dimensions for Magnet Access

## 4.3.2 Spectrometer and Accessories Transport Dimensions and Weights

Spectrometer System (spectrometer crate)	Crate Size (m)			Weight (kg)	Dimension (m) for Transport to Magnet Room		
	L	D	H		Width Crated*	Width Uncrated*	Height Uncrated
AVANCE III HD TwoBay	1.54	1.03	1.54	400	1.05	0.82	1.67

Note: The pallet is now integrated into the crate. Weights include pallets and packing material as required. Weights are for a standard AVANCE™ configuration, actual weights may increase depending on options selected.

\* Transport width = width indicated + minimum 1 cm clearance on each side. These are the widths if the console is inserted lengthways through the entrance.

Table 4.2: Door Dimensions for Magnet Room Access: Spectrometers

Accessory	Crate Size (m)			Weight (kg)
	L	D	H	
BMPC II	1.05	0.90	1.52	250
SampleXpress	0.96	0.96	0.52	48
SampleXpress Lite	0.57	0.69	0.42	22
SampleJet	1.20	0.80	1.20	100
SampleJet Cooling Option – Carousel Box	0.56	0.56	0.33	~10
SampleCase box 1/box2	1.89/0.75	0.52/0.75	0.27/0.65	15/15
BCU-I	0.48	0.36	0.43	50
BCU-II	0.58	0.42	0.57	74
CryoProbe (shipped in a CryoCase on a pallet)	1.20*	0.80	0.68	60
CryoCooling Unit	1.66	0.95	0.68	400
CryoProbe System He Compressor Indoor Water-cooled	0.94	0.84	1.18	120
CryoProbe System He Compressor Indoor Air-cooled (packed in three cartons on one pallet)	0.69	0.69	1.12	140
CryoProbe System He Compressor Outdoor Air-cooled (packed in three cartons on one pallet)	0.55	0.55	0.90	140

The accessories are typically transported to the magnet on a pallet jack. Weights include pallets and packing material as required.

\*The length and weight of the CryoCase may vary depending on the magnet model.

Table 4.3: Crate Dimensions and Weights for Accessories

## 4.4 Rigging Equipment

All rigging equipment must be selected to handle the size and transport weights of the magnet system. For Ultra High Field magnet systems, a crane or a boom-truck is required to remove the magnet from the truck and place it on the dock or slab in front of the access doors to the building. Air skates should be used during transport over floors and through passage ways whenever possible. For lifting during installation, hydraulic lifts are preferred.

Rigging equipment is not included with the NMR system order. The following rigging equipment will be needed for a typical delivery and installation of an NMR magnet system:

- **Crane:** A crane able to handle magnet load is required to lift the magnet off the truck, place it on a flat surface for un-crating, and lift it again and place it on air-skates in front of the access doors, or to place the magnet inside the building (e.g. roof hatch).
- **Leveling Sheets:** Masonite (or other suitable material) sheets may be temporarily required to level the transport route from the access doors to the laboratory, in case of small imperfections.
- **Air-Skates:** A set of four air-skates is required to transport the magnet from the access doors. The air-skates require an air-compressor capable of supplying up to ca. **1.72 bar (25 psi) at ca. 2 cu. meter/minute**.
- **Hydraulic Lifting System (Gantry) :** Lifting the magnet inside the laboratory during assembly phase is typically done with a hydraulic gantry capable of handling the magnet load within the given ceiling height (please refer to [Ceiling Height Requirements \[ 27\]](#)).

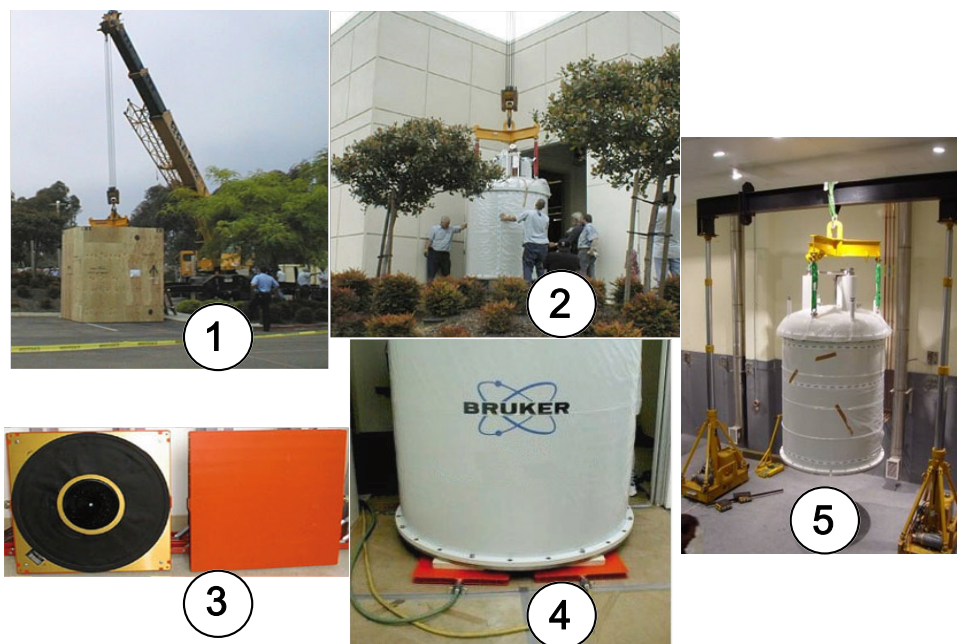

Figure 4.1: Unloading the Magnet Crate and Placing on Air Skates

1.	Unloading the magnet crate and positioning for uncrating.
2.	Lifting the magnet and placing it on air skates in front of the access doors.
3.	Air skates.
4.	Magnet positioned on air skates.
5.	Hydraulic gantry in the magnet room.

## 5 Ceiling Height Requirements

The assembly of the magnet system, the magnet energization, and refills with liquid helium require minimum height clearances.

- The ceiling height requirements for the magnet installation and cryogen refills do not need to be met over the entire laboratory. The height requirements need only be met immediately above the magnet, over an area to allow for assembly of the lifting system (if applicable), and over an area to allow for insertion of the helium transfer line.
- If a soffit is to be used, it is important to consider the area of raised ceiling needed to set-up the lifting system being used to lift the magnet during the assembly phase of the installation. If a transverse I-beam is used in conjunction with the lifting system, this must fit within the confines of the soffit.
- In lieu of a lifting system, a fixed lifting hook capable of supporting the magnet at a sufficient height can be used to assemble the magnet. However, this option is usually not ideal. See notes below.



Figure 5.1: Area of Maximum Ceiling Height Needs to be Extended to Allow for the Lift System's I-beam

### WARNING

#### Fixed Hook



Danger to personnel and equipment due to falling lifting system when using a fixed hook. Removing the heavy hoist directly over the magnet can be very difficult and dangerous for both personnel and the magnet.

- ▶ It is important to consider how the hoist system and harness will be removed from a fixed lifting hook after the magnet is installed.
- ▶ Ensure that the hook is certified to hold the weight of the equipment before use.

## 5.1 Helium Transfer Line

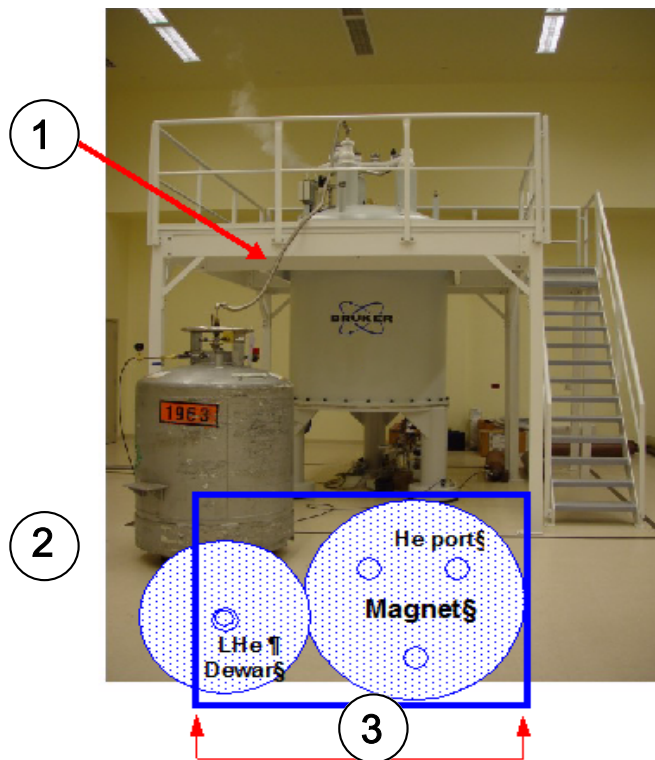

Figure 5.2: Helium Transfer Line Insertion

1.	Transfer line length = 3.6 meters (11' 10") for the flexible section.
2.	When using ceiling boxes (soffits), sufficient space must be left for the required transfer line length. The magnet may need to be off-center within the soffit.
3.	Respective ceiling height requirements must be met over this area.

## 5.2 Minimum Ceiling Height

Magnet Type	Minimum Ceiling Height		Minimum Hook Height (m)
	For Magnet (m)	For He Transport Dewar (m)	
Ascend 850	3.60	3.60	3.70

\* Hook height needed when using the standard lifting harness from Bruker as shown in [Figure 5.1 \[ 27\]](#). A reduced hook height is possible using alternate lifting accessories.

Table 5.1: Minimum Ceiling Height Requirements Inside the Magnet Room

## 6 Magnetic Stray Fields

Magnetic stray fields are three dimensional, and extend further in the vertical direction than in the horizontal direction.

A number of studies have been carried out on the long term **effects of magnetic fields on personnel**. As a general rule the working place (e.g. workstation, sample preparation area etc.) must be placed outside the **0.5 mT (5 G)** line. For further information on acceptable magnetic field limits contact your countries health authorities or your area Bruker office.

### 6.1 Horizontal and Vertical Stray Fields

The following table displays the horizontal stray fields (distances are measure in the *radial* direction from the magnet center), as well as, the vertical stray fields (distances are measure in the *axial* direction from the magnet center).

**Please note all measurements in the following table are in meters!**

Horizontal Stray Fields						Vertical Stray Fields					
50 G	10 G	5 G	2 G	1 G	0.5 G	50 G	10 G	5 G	2 G	1 G	0.5 G
1.0	1.35	1.6	2.0	2.5	3.3	1.5	2.2	2.7	3.2	3.9	4.8
The distance from floor to magnet center is 1.2 meters.											

Table 6.1: Magnetic Stray Fields for the 850/54 Ascend Magnet

## 6.2 Stray Field Plots

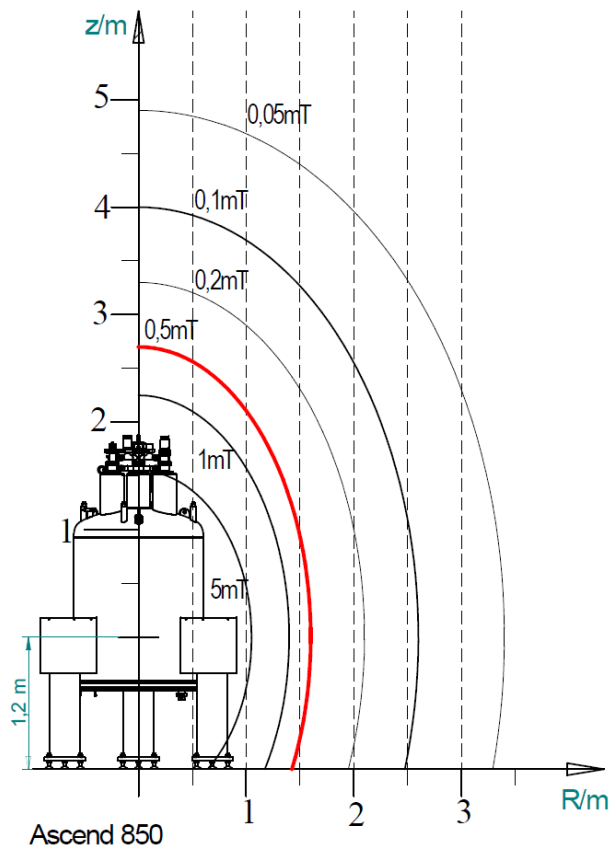

Figure 6.1: Magnetic Stray Field Plot Ascend 850/54

# 7 Environment and Site Survey Measurement

This chapter covers the various site survey topics related to the NMR laboratory. The measurements and associated guidelines include:

- Vibrations
- Magnetic Environment
- Electromagnetic Interference: DC and AC EMF
- RF Interference



**Note:** The results of measurements carried-out during a site survey only reflect the specific conditions that were present during the survey. Although these results are useful as a reference, they would not be conclusive for the after-the-installation system performance if one or more site conditions change. These changes may be related but not limited to sources of vibrations and electromagnetic field and RF interference like electro-mechanical equipment (HVAC, motors, pumps, freezers, etc.), elevators, car/bus/train traffic, power lines, transformers, radio/TV stations and other possible RF sources.

## 7.1 Vibrations

External vibrations may cause field modulations in the sample cavity. This could result in vibration sidebands, matched NMR signals that appear on either side of a main signal peak. The effect of vibrations on NMR performance will depend on the type of work being carried out, the type of system and the site building materials.

- Ideally the site should be at basement level, or on the ground floor (slab on grade), to minimize building vibrations.
- Possible sources of vibrations are generators, compressors, fans, machinery etc. Vibrations from external sources such as cars, trains, airplanes, and construction sites can also cause problems.
- Measuring the extent of vibrations at the magnet location is a relatively simple matter; if you suspect a problem you should contact your local Bruker office.

The thresholds listed in the section [Floor Vibration Guidelines: Bruker API Damping System \[ 33\]](#) correspond to vibration related NMR sidebands reaching the height of  $C^{13}$  satellites in the  $CHCl_3$  line shape spectrum. These thresholds might not meet the needs for demanding NMR applications.

The height of vibration sidebands is approximately linear with the floor acceleration levels, meaning that an NMR application requiring smaller sidebands than the height of  $C^{13}$  satellites would need to have reduced floor acceleration thresholds by the same percentage factor.

### 7.1.1 General Vibration Guidelines

#### General guidelines for buildings

The common standards for floor vibrations related to the impact on sensitive tools and instruments are known as the VC curves and are presented below.

Criterion Curve	Amplitude $\mu\text{m/s}$ ( $11\mu\text{i/s}$ )*	Description of Use
Workshop (ISO)	800 (32 000)	Distinctly perceptible vibration. Appropriate to workshops and nonsensitive areas.
Office (ISO)	400 (16 000)	Perceptible vibration. Appropriate to offices and nonsensitive areas.
Residential day (ISO)	200 (8 000)	Barely perceptible vibration. Appropriate to sleep areas in most instances. Usually adequate for computer equipment, hospital recovery rooms, semiconductor probe test equipment, and microscopes less than 40x.
Operating theater (ISO)	100 (4 000)	Vibration not perceptible. Suitable in most instances for surgical suites, microscopes to 100x and for other equipment of low sensitivity.
VC-A	50 (2 000)	Adequate in most instances for optical microscopes to 400x, microbalances, optical balances, proximity and projection aligners, etc.
VC-B	25 (1 000)	Appropriate for inspection and lithography equipment (including steppers) to 311m line widths.
VC-C	12.5 (500)	Appropriate standard for optical microscopes to 1000x, lithography and inspection equipment (including moderately sensitive electron microscopes) to 1 11m detail size, TFT-LCD stepper/scanner processes.
VC-D	6.25 (250)	Suitable in most instances for demanding equipment, including many electron microscopes (SEMs and TEMs) and E-Beam systems.
VC-E	3.12 (125)	A challenging criterion to achieve. Assumed to be adequate for the most demanding of sensitive systems including long path, laser- based, small target systems, E-Beam lithography systems working at nanometer scales, and other systems requiring extraordinary dynamic stability.
VC-F	1.56 (62.5)	Appropriate for extremely quiet research spaces; generally difficult to achieve in most instances, especially cleanrooms. Not recommended for use as a design criterion, only for evaluation.
VC-G	0.78 (31.3)	Appropriate for extremely quiet research spaces; generally difficult to achieve in most instances, especially cleanrooms. Not recommended for use as a design criterion, only for evaluation.
<p>*As measured in one-third octave bands of frequency over the frequency range 8 to 80 Hz (VC-A and VC-B) or 1 to 80 Hz (VC-C through VC-G).</p> <p>The information given in this table is for guidance only. In most instances, it is recommended that the advice of someone knowledgeable about applications and vibration requirements of the equipment and processes be sought.</p> <p>Source: Reprinted with permission from Colin Gordan Associates.</p>		

Table 7.1: Application and Interpretation of the Generic Vibration Criterion (VC) Curves

## 7.1.2 Measuring Floor Vibrations

Bruker offers a service for measuring floor vibrations using specialized hardware and software. We recommend measurements to be done over a period of at least 1 hour (ideally much longer) to try capturing both steady state conditions and transient events.

Furthermore, we recommend a measurement resolution of  $\leq$  to 0.125 Hz, enabling the collection of correct amplitudes in the low frequency range.

Also we recommend simultaneous measurements (multiple transducers) along the 3 axis (vertical, 2 horizontal).

## 7.1.3 Floor Vibration Guidelines: Bruker API Damping System

The Ascend 850 magnet is equipped standard with air piston damped isolators (API), which are effective in mitigating both vertical and horizontal vibrations.

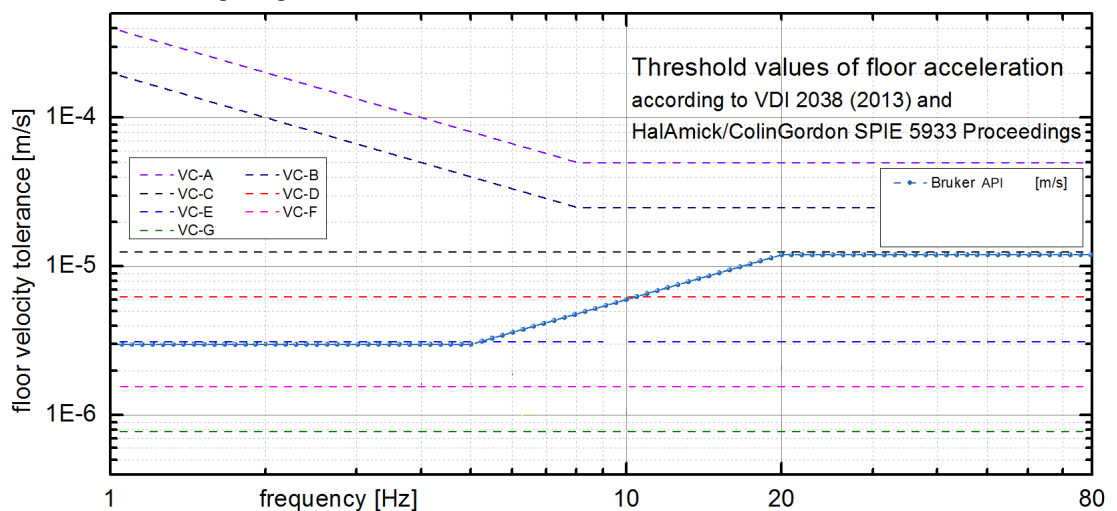

Figure 7.1: Floor Velocity vs. Frequency Plots for Generic Vibration Criterion (VC) and for the Bruker Magnet with API

Frequency	Maximum Velocity in Vertical Direction	Maximum Velocity in Horizontal Direction
1-5 Hz	3 $\mu$ m/s	3 $\mu$ m/s
5-20 Hz	3...12 $\mu$ m/s	3...12 $\mu$ m/s
>20 Hz	12 $\mu$ m/s	12 $\mu$ m/s

Table 7.2: Maximum Floor Velocity Thresholds for the Bruker Magnet with API

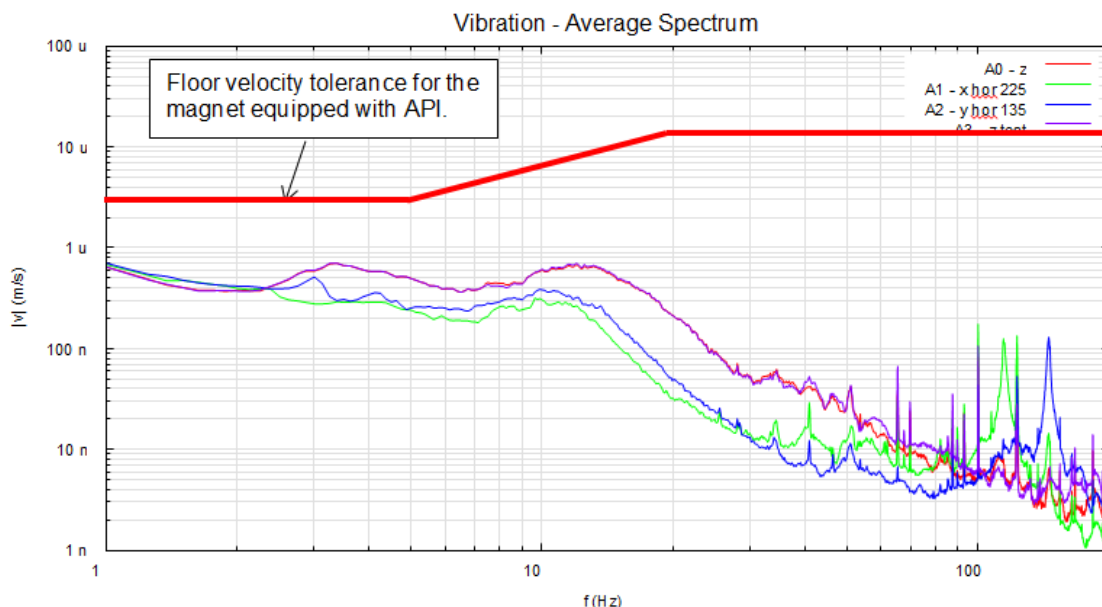

Figure 7.2: Example of an Average Spectrum Measurement with 0.125 Hz Resolution, 1-200 Hz Frequency Range and 60 Minutes Recording Time

## 7.2 Magnetic Environment

The presence of any ferromagnetic materials in the immediate vicinity of the magnet will decrease the magnets homogeneity and may degrade overall performance. Although minimum requirements for routine NMR are not stringent, the magnetic environment must be optimized if more sophisticated experiments are being carried out. Usually, the effect of metal pipes, radiators, and other such objects can be “shimmed out”, but whenever possible, this should be avoided.

### 7.2.1 Guidelines for Static Objects

The next table gives a list of common sources of magnetic interference. These items should be located according to the recommendations below. It must be emphasized however, that such recommendations represent a situation that may not be achievable. Please consult with Bruker for possible solutions if one or more of these recommendations cannot be satisfied.

Object	Actual distance from magnetic center (m)
Steel reinforced walls	3
Radiators, plumbing pipes	3
Metal table, metal door	3
Filing cabinet, steel cabinet	3
Iron or steel beams	3
Massive objects, e.g. boiler	3

Table 7.3: Recommendations for Static Magnetic Objects

## 7.2.2 Guidelines for Moving Objects

The table below serves as a guideline for moveable magnetic material.

Object	Actual distance from magnetic center (m)
Steel cabinet doors	3
Large metal door, hand trolley	4
Elevators*	6
Trucks, cars, fork-lifts	9
Trains, subways, trams	30
*Elevators, trains and trams are more likely to be a source of vibrational interference. Note that D.C. operated elevators, trains, and trams may cause disturbances over much larger distances.	

*Table 7.4: Guidelines for Moveable Magnetic Objects*

## 7.3 Electromagnetic Interference

Possible sources of interference are power lines which may carry fluctuating loads, heavy duty transformers, large electric motors, air conditioning systems, power transformers, etc. The fluctuating electromagnetic fields arising from such devices can interfere with the magnet and cause spatiotemporal field instabilities. Of particular concern are sudden changes in load as may be produced by elevators, trams, subways etc.

Other sources of interference include radio and television stations, satellites and other HF transmitters that may operate in the vicinity of NMR frequencies of interest.

The effect of such interferences on the NMR/MRI/micro-imaging results strongly depends on various parameters, such as the experiment itself, digital lock parameters, lock substance, experiments (pulse programs), 2H S/N, magnet generation and temperature and if there is a digital lock at all.

If you suspect that you have a source of interference located near the proposed magnet site then you should contact Bruker BioSpin for a site survey.

Bruker offers a service for measuring EMF interferences using specialized hardware and software. We recommend measurements to be done over a period of at least one hour (ideally much longer) to try capturing both steady state conditions and transient events. However, often there is a need to do much longer measurements, including overnight.

### 7.3.1 Types of EMF Interference

- DC interference (up to 1 Hz).
- AC interference (from 1 Hz up to 200 Hz, especially 16 2/3 Hz\*, 50 Hz, 60 Hz and harmonics).
- HF Interference.

\* 16 2/3 is the standard for long distance train power lines.

## 7.3.2 DC EMF Interference

DC interferences (0-1 Hz) generally come from devices operated on DC, such as subways, trams, trolley-bus, suburban trains, etc. The locations of both the device and its power supply and lines relative to the proposed NMR site are essential to the amplitude and orientation of DC fields and how they may interfere with the NMR system. DC feeder lines are just as disturbing as the vehicle itself and they do not run necessarily parallel to the track.

Moving iron (or other ferromagnetic materials) may cause DC interferences:

- Trains
- Trucks & Cars
- Elevators
- Forklifts
- Doors
- Large parts with magnetic material (steel cabinets, containers)

### 7.3.2.1 Measuring DC Fluctuating Fields

DC EMF measurements should be conducted using a 3 axis **fluxgate magnetometer** placed at the location of the planned magnetic center. The fluxgate sensors must be capable to accurately measure fields in the range  $\pm 100 \mu\text{T}$  (or better  $\pm 1 \text{ mT}$  in a laboratory with unshielded magnets). The quality of the fluxgate sensors and acquisition system should result in accuracy better than 5 nT. The sensor signals are recorded with an analog data acquisition system at a sampling rate of 2'500 S/s or more. The data is processed (digital LP-filter with  $f_c = 1.3 \text{ Hz}$ ) and subsampled to 2 S/s so that the AC ( $> 1 \text{ Hz}$ ) components are efficiently suppressed. Measurements should be performed during actions in the environment causing field changes. Typically this results in a measurement during a full working day (9 to 17) and performing all actions causing DC interferences (such as moving a forklift or operating an elevator). In addition, an over-night measurement is recommended to separate singularities from constantly present interferences.



The measurement of DC and AC EMF interference can be performed with the same hardware (fluxgates). The recorded waveform is processed in different ways.

### 7.3.2.2 Guidelines for DC Interference

When determining the effect of fluctuating magnetic fields, two parameters are important: the size of the fluctuation and the rate of change, as follows:

- In a moving window of 1000 seconds the difference of the maximum and minimum values from the filtered and sub-sampled data set should not exceed:

$$\Delta B = B_{\max} - B_{\min} < 1400 \text{ nT (peak to peak) for the frequency range } 0 \dots 1 \text{ Hz.}$$

Note this guideline is shown with a red line in the figure [Figure 7.3 \[p 38\]](#) (the threshold of 700 nT represents 0 to peak).

- The absolute value of the derivative should not exceed:

$$\left| \frac{dB}{dt} \right| < 314 \text{ nT/s.}$$

Note this guideline is shown with a green line in the figure [Figure 7.3 \[p 38\]](#).

The distance to subways, trams and DC feeder lines should be at least 100 m.

### 7.3.2.3 Reducing DC Interference

---

Two Bruker technologies help to suppress the DC field perturbations:

- Modern magnets with EDS™ technology (External Disturbance Suppression) efficiently suppress interferences by a factor ~25-1000, depending on the model and disturbance frequency.
- The advanced digital lock (if present) further suppresses the field fluctuations at the sample. Depending on various parameters, its efficiency varies considerably. Lock hold (for example during gradient pulses) and a strong external field change may lead to difficulties.

### 7.3.3 AC EMF Interference

---

In high resolution NMR AC disturbances in the frequency range of 1Hz to several 100 Hz cause modulation sidebands in NMR spectra, as long as the disturbance frequency is equal to or larger than the line width. As long as these sidebands are small in amplitude they disappear in the noise floor. Above 1 Hz, the most prominent disturbances usually originate from electrical power and devices that rotate/move with the according frequencies (16-2/3 Hz and 50/60 Hz and harmonics). But also other field components at other frequencies may be present in laboratory environments.

Typical sources for 16-2/3 Hz interferences are long distance trains and/or streetcars. Likewise, the 50/60 Hz interferences have their sources in electrical wiring, transformers and fluorescent lights located in the vicinity of the NMR spectrometer.

#### 7.3.3.1 Measuring AC EMF Interferences

---

AC EMF measurements should be conducted using a 3-axis fluxgate magnetometer placed at the location of the planned magnetic center and console. The fluxgate sensors must be capable to accurately measure fields in the range  $\pm 100 \mu\text{T}$  (or better  $\pm 1 \text{ mT}$  in a laboratory with unshielded magnets). The quality of the fluxgate sensors and acquisition system should result in accuracy better than 5 nT. The sensor signals are recorded with an analog data acquisition system at a sampling rate of 2'500 S/s or more. The data is block-wise (4 seconds) processed: digital LP -filter with  $f_c = 225 \text{ Hz}$ , subsampled to 500 S/s, FFT (200 Hz band width and 0.25 Hz resolution). The single block magnitude spectra are used to compute average and peak-hold spectra as well as spectrograms (waterfall plots) reflecting the evolution of AC EMF spectral content over time. Measurements should be performed when possible sources are in operation. Typically this results in a measurement during a full working day (9 to 17). In addition, an over-night measurement is recommended to separate singularities from constantly present interferences.



---

The measurement of DC and AC EMF interference can be performed with the same hardware (fluxgates). The recorded waveform is processed in different ways.

---

In case large disturbances are detected at the planned magnet center or the console area, specific locations must be checked to identify possible sources such as:

- Along the wall inside the laboratory at 5 cm (~2") from wall, and 3.8 cm (4") from wall
- Approximately 5 cm (~2") below the existing lights in the room
- Near the main outlets 230V (USA - 208V) locations in the room
- Neighboring rooms and installed machines/devices in there.
- The paths towards tram, train, subway lines, power stations, etc.

Based on the results, a strategy to reduce AC interferences can be worked out (see [Reducing AC EMF Interference \[p 38\]](#))

### 7.3.3.2 Guidelines for AC EMF Interference

**Between 1 Hz and 10 Hz:** NMR systems are usually more sensitive to external disturbances in this frequency range. It is suggested to stay below a straight line defined by 70 nT at 1 Hz and 700 nT at 10 Hz in a log/log magnitude/frequency plot. These are 0 to peak values. See figure below.

**Above 10 Hz:** Maximum 700 nT magnitudes (0 to peak) can be tolerated for interferences with frequencies above 10 Hz.

Rough Guidelines for EMF Disturbances

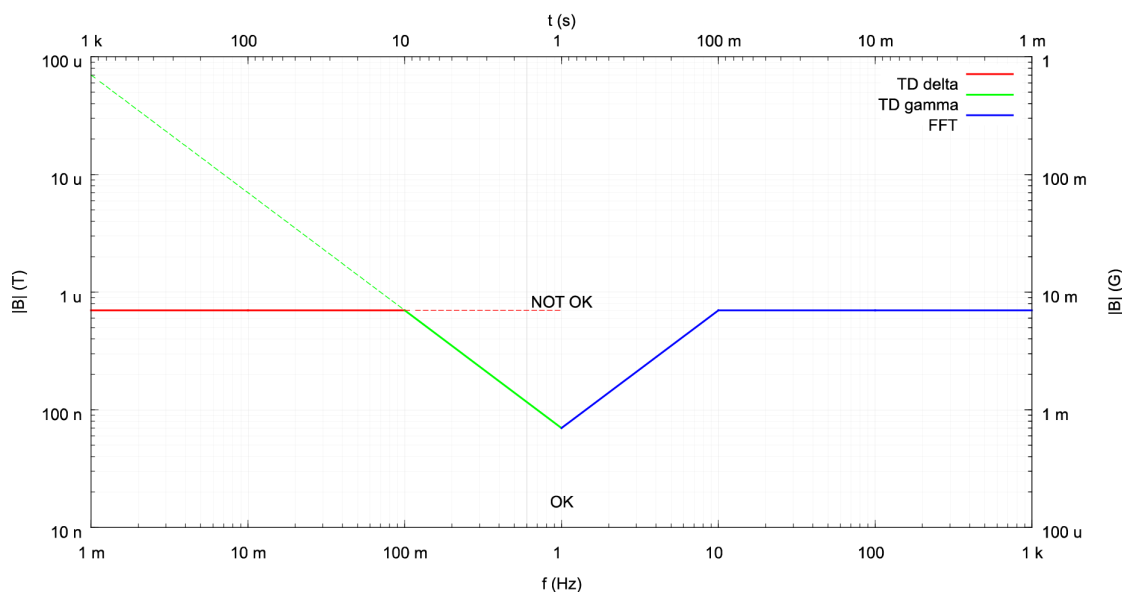

Figure 7.3: Specification Framework with the Magnetic Field Represented as 0 to Peak Values

### 7.3.3.3 Reducing AC EMF Interference

Two Bruker technologies help to suppress the DC field perturbations:

- Modern magnets with EDS™ technology (External Disturbance Suppression) efficiently suppress AC interferences by a factor ~25-10000, depending on the model and disturbance frequency. Above 1 Hz, one can generally state: the higher the frequency the better the suppression and the less sensitive NMR is to interferences.
- The advanced digital lock (if present) further suppresses the field fluctuations at the sample. Depending on various parameters, its efficiency varies considerably.

## 7.3.4 HF Interference

The NMR instrument is effectively a very sensitive radio frequency receiver. Possible sources of interference are local radio or television broadcasts, low Earth orbit satellite systems, and signals emitted by personal paging systems. Of particular concern will be interference at frequencies at which NMR experiments are carried out. Although the interference effects will depend greatly on the strength of the transmitter, as a rule of thumb only broadcasting transmitters located within a radius of approximately 5 kilometers (3 miles) are likely sources of interference.

HF interference may also occur between two or more spectrometers located in close proximity and operating at the same nominal 1H resonance frequency.

### 7.3.4.1 Most Commonly Studied Nuclei

Magnet Type	1H	2H	11B	13C	15N	19F	27Al	29Si	31P
Ascend 850	850.130	130.500	272.755	213.765	86.176	799.921	221.517	168.897	344.14

Table 7.5: List of Most Commonly Studied Nuclei and Corresponding Resonance Frequencies

### 7.3.4.2 Measuring HF Fluctuating Fields

Radio Frequency Interference measurements should be conducted using a spectrum analyzer. The analysis should be done for the resonance frequency of each of the nuclei of interest (proportional to the 1H resonance frequency of the spectrometer). The minimum frequency sweep is 400 kHz.

### 7.3.4.3 Guidelines for HF Interference

As a general guideline the level of any HF interference should be less than an electrical field strength of 80 dB $\mu$ V/m/300kHz at the side of the magnet.

### 7.3.4.4 Reducing HF Interference

Screening a site for possible HF Interference is complicated and expensive. Shielding of the laboratory with a Faraday cage is a possible solution, though having to take such measures is quite rare.

When designing and manufacturing the Bruker spectrometers, care is taken to provide adequate shielding and the instruments rarely suffer from interference in normal HF environments. Furthermore, the advanced BSMS digital lock system - included with all Bruker AVANCE spectrometers - allows a shift in the 2H lock frequency with certain limits. This may allow enough variation in the absolute magnet field strength to shift the NMR signal away from that of local broadcasting frequencies.

HF interference may occur between two or more spectrometers located in close proximity and operating at the same nominal 1H resonance frequency. These problems can be avoided by energizing the different magnets at slightly different fields, such that their operational frequencies are separated by ~ 200 kHz at the nominal 1H resonance frequency.



# 8 Utility Requirements

## Contents:

[Electrical Power Requirements \[▶ 41\]](#)

[Telecommunication \[▶ 43\]](#)

[Compressed Gas \[▶ 43\]](#)

[Liquid Nitrogen Requirements \[▶ 48\]](#)

[Cooling Water \[▶ 48\]](#)

[Lighting \[▶ 49\]](#)

[HVAC \(Heating Ventilation Air Conditioning\) \[▶ 49\]](#)

[Emergency Ventilation During Installation and Quenches \[▶ 51\]](#)

[Fire Detection System and Fire Extinguishers \[▶ 53\]](#)

## 8.1 Electrical Power Requirements

---

When planning the electrical power requirements of your site make provision for extra equipment which you may install, e.g. personal computers, workstations, air conditioning systems, etc.

---

**Note:** The Bruker UltraStabilized systems require a pump to sub-cool the liquid helium surrounding the coil. During a power outage, this pump is supplied with power by an uninterrupted power supply (UPS) which will ensure power for several hours.



**If the power outage exceeds the backing capacity of the UPS battery pack, the pump will stop, which in turn will lead to a slow temperature increase of the sub-cooled helium. This temperature rise will be very slow and the magnet may only experience a quench after several days if no action is taken.**

In this case, the system may be down for several weeks and will require reinstallation. The standard system is equipped with 9 hours of backup capacity for the magnet pump assembly. If power failures longer than 9 hours are likely in the area of installation, it is the responsibility of the customer to take appropriate provisions for emergency power.

---

### Power Supply for the BMPC II

Power is routed to the BMPC II through the UPS which also has the advantage of serving as a line conditioner. In the event of a power failure, the power source automatically switches to the UPS batteries. It is recommended to have back-up power for this through an emergency electrical power generator.

# Utility Requirements

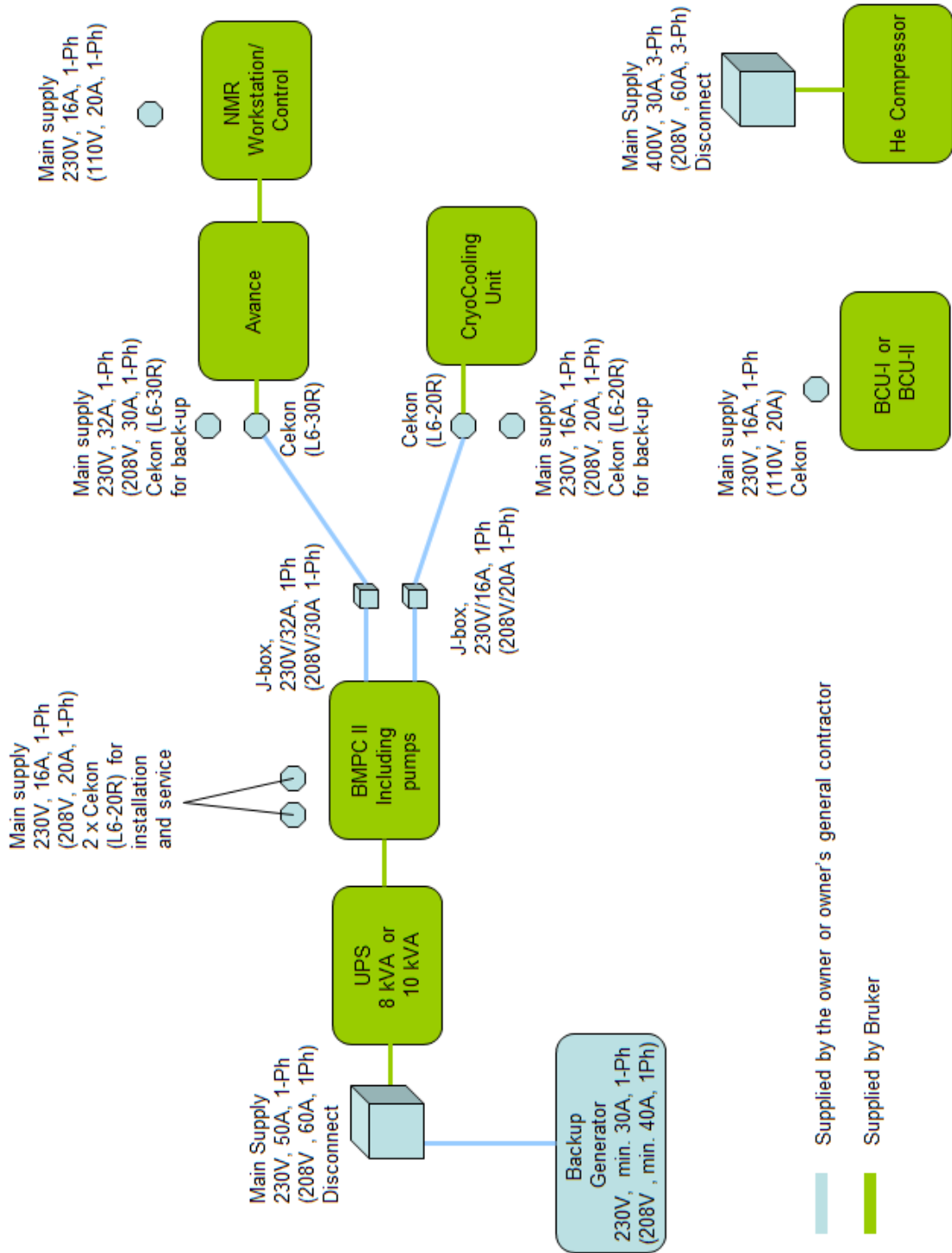

Figure 8.1: Main Electrical Power Requirements Flowchart

## 8.2 Telecommunication

---

Please refer to the AVANCE NMR layout in chapter [Floor Plan \[▶ 55\]](#). The following ports/connections are required:

- Telephone/data ports behind the workstation.
- Ethernet cable between the AVANCE cabinet and the workstation.

## 8.3 Compressed Gas

---

Some components of the AVANCE system and the vibration isolators, which are integrated into the magnet legs, operate with compressed gas.

### 8.3.1 General Requirements

---

**Compressed gas line:** The standard AVANCE system requires one compressed gas line with at least two regulated outputs.

**Regulators:** Each output should terminate with a regulator (including gage head) suited for a pressure range of 0 - 8.6 bar (0 - 125 psi). The output of the regulator should allow the quick connect for an 8 mm diameter gas tube..

- Compressed nitrogen gas needed for temperature control with VT experiments in order to achieve optimal NMR performance. For example, the BCU-I cooling unit requires a dew point of -51°C (-60°F) for the compressed gas.
- Compressed air or nitrogen gas for spinning.
- Compressed air or nitrogen gas for sample ejection, and for the magnet's vibration isolation units.
- Compressed air or nitrogen gas for the optional CryoProbe system.

### 8.3.2 Gas Supply

---

**Option 1 (preferred):**

Nitrogen gas only.

**Option 2:**

Nitrogen gas for VT work only, dry air for the rest.

**Notes:**

- A nitrogen separator (offered by Bruker as an option) can be built into the AVANCE cabinet as an available solution. This will produce the nitrogen gas required for VT work. However, this is not suitable for larger flow rates required by MAS experiments.  
The nitrogen separator is suitable for use with the BCU-I cooling unit. However the nitrogen output from the separator is not pure enough and this unit should not be used with a N2 exchanger or BCU-II cooling unit for low temperature work.
- If a CryoCooling unit is to be installed, a secondary regulator, T-split from the supply line is recommended.
- The Emergency Sample Protection Device is used in conjunction with the CryoProbe system, and requires a cylinder of air or nitrogen gas.

System	Operating Pressure	Recommended Flow*
AVANCE	6-8 bar (80-120 psi)	57 l/min. (~2 cfm)
AVANCE + Sample Changer	6-8 bar (80-120 psi)	100 l/min. (~3.6 cfm)**
AVANCE + MAS	6-8 bar (80-120 psi)	300 l/min. (~11 cfm)

\* This is the actual consumption and minimum needed at the instrument input after the N2 supply (either a bulk tank, or a N2 separator).

\*\* A recommended flow of 100 liters/min. per sample for sample exchange (about 1 minute), average consumption will depend on the number of samples being used.

For non-MAS work, if an air-compressor and N2 separator are used, the flow requirements are 50% higher, i.e. 3 cfm. (It is recommended to use a dual unit oil-less air-compressor rated at minimum double capacity of the specified requirement. Please refer to the next section on air compressors).

Table 8.1: Pressure and Flow Requirements

### 8.3.3 Other Specifications

#### Oil Content:

Oil-free.

#### Water Content:

For the BCU-I cooling unit the compressed gas should have a dew point of -51°C (-60°F). For the BCU-II cooling unit, the dew point requirement is -80°C (-112°F).

For room temperature work and higher: Dew point of < 4°C (39.2°F).

For low temperature work: The dew point must be at least 20°C (68°F) below the operating temperature.

If a cooling unit is used, then the dew point of the compressed nitrogen should be at least 10°C (50°F) below the temperature at the heat exchanger output.

#### Solid Impurities:

Use 5 micron filters for high resolution NMR. For MAS probes use 1 micron filters. The filters should retain a minimum of 99.99% of the specified particles.

#### VT Nitrogen Gas Quality

Proton Frequency (MHz)	Purity (volume percentage)
500	≥ 95
600-800	≥ 96
850-1000	≥ 97

Table 8.2: VT Nitrogen Gas Quality (500 MHz and above)

### 8.3.4 Compressed Air System

When designing a suitable compressed air system the following points must be taken into consideration:

- To prevent magnetic impurities from entering the magnet use only copper or stainless steel lines. Do not use iron or steel pipes. Plastic piping is unsuitable where very low dew points are required. Water vapor in the air will permeate plastic piping limiting minimum dew points to typically  $-25^{\circ}\text{C}$ .
- To avoid surges in the air pressure (e.g. during sample lift) install a container of 10-20 liters in the air supply line to act as a buffer. Locate the buffer after the dryers in the supply line. **Buffer containers** must meet the appropriate safety requirements. They must have a working pressure of 16 bar and be proofed up to 30 bar. Use tanks which are internally coated with water and acid resistant material. This will prevent corrosion from impurities such as  $\text{SO}_2$ .

The three major components in a suitable compressed air supply line include the compressor, dryer and appropriate filters:

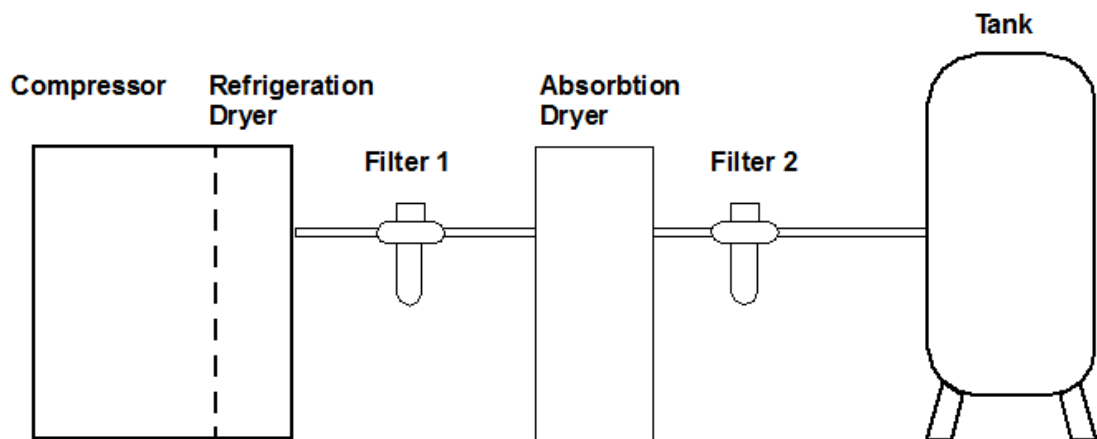

Figure 8.2: Example of a Typical Dryer/Filter System Setup

Filter 1:	General purpose liquid and dust removal filter ( $0.1 \text{ mg/m}^3$ - 0.1 ppm, 1 micron).
Filter 2:	High-efficiency dust, liquid and aerosol filter ( $0.1 \text{ mg/m}^3$ - 0.01 ppm, 1 micron).

When using a dryer/filter system setup, the following questions should be addressed:

- Pressure loss in piping?
- Efficiency loss in dryer?
- Pressure loss in filter?
- What is the required pressure?
- What is the required flow rate?

### 8.3.4.1 Air Compressors

---

When choosing an air compressor the following points should be considered:

- Ideally the compressor should be installed in a **dust free**, cool (use air conditioning as required) and dry place.
- The compressor must be **oil-free**. This can be achieved by using membrane or Teflon coated piston and scroll compressors. The compressor should be fitted with a fine dust inlet filter.
- The compressor must be capable of delivering the required flow rate and pressure suited to your particular system (see Compressed Gas Requirements). Generally the compressor should be large enough so it does not run continuously (e.g. > 50% of the time), which will cause overheating.
- The extra cost of choosing an oversized system may often be justified. The reduction in duty cycles will lower maintenance costs and extend the life of the system. A suitable compressor coupled to an adequate buffer will ensure a more **constant flow rate** leading to better performance. When spinning, the system uses a constant flow of air, but surges will occur during sample lift. When referring to Compressed Gas Requirements you should add on 10 l/min. to the average consumption if the system is fitted with anti-vibration devices such as pneumatic dampers or a VIP system.
- Take into account the **pressure loss** along the line between the compressor and the final gate valve. The pressure drop depends on the pipe diameters. An internal diameter of 8 mm has been found to be suitable. The plastic tubing used to carry the supply from the final gate valve to the console has an outside diameter of 8 mm and is supplied by Bruker.
- Some types of **dryers**, e.g., absorption dryers can use up to 25% of the air flow to regenerate the drying material. If this type of dryer is used then the output capacity of the compressor must be sufficient to supply this requirement.
- Many compressors are fitted with dryer and a tray to collect **excess water**. Regular checking of the dryer and emptying of the water collector will ensure trouble free operation. This arrangement is quite satisfactory in environments with normal humidity (< 80%). However in areas of higher humidity (> 80%) a cooling coil with an automatic water drain must be fitted to the compressor outlet. This will ensure that filters do not become overloaded.
- Although not directly concerned with air quality, compressors are a **source of vibrations** which may interfere with NMR performance. You should consider using a compressor fitted with a vibration damping housing if it is to be situated close to the spectrometer. The output noise level should be < 75 dBA.

### 8.3.4.2 Dryers

---

#### Refrigeration Dryers

This type of dryer removes moisture from gas by cooling to within a few degrees of the freezing point of water. The condensed moisture is removed in a separator and drain trap mechanism located immediately downstream of the dryer. This drain should be valve switched automatically.

##### Advantages

- None of the compressed gas is wasted in regeneration which is more suitable if the capacity of the compressor is marginal.
- Maintenance free.
- Not as susceptible to oil mist contamination as adsorption dryers, thus do not have the same need for pre-filters.

##### Disadvantage

- These type of dryers are limited because of their inability to produce very low dew points. The recommended dew point for room temperature work of 4°C is only just achievable. Therefore if low temperature NMR is to be carried out, this type of dryer is unsuitable.

#### Absorbtion Dryers

The air is passed through cartridges of synthetic zeolite known as Molecular Sieves. The sieves are hygroscopic and retain water molecules when air is passed through them. Two sieves are normally used alternately. A portion of the dry air output of sieve A is fed into sieve B to regenerate it. The amount used in regeneration is typically 15% but up to 25% may be required for very low dew points. The process is automatically reversed at regular intervals with the output of sieve B used to regenerate sieve A.

##### Advantages

- Much lower dew points are achievable compared to refrigeration dryers.
- Automatic Regeneration: Normally the sieves will last for many years if they do not become contaminated with oil, e.g. from mist in the air.
- The drying agent may be easily replaced.

##### Disadvantages

- Up to 25% of throughput is used to achieve the automatic regeneration.
- Requires the use of more dust filters.
- Filters at the input (oil < 0.01 mg/m<sup>3</sup>) are required due to the susceptibility to oil contamination from mist in the air.
- The use of absorption dryers may lead to the generation of dust and so the dried air output must be fed through an appropriate filter (1 micron).
- These dryers require more maintenance than refrigeration dryers.
- They can be noisy when switching between the two cartridges.
- Due to the different absorption rates of nitrogen and oxygen the **N<sub>2</sub>/O<sub>2</sub> composition** may change. To prevent this, an absorption dryer should be placed between the compressor and buffer tank.

### 8.3.4.3 Filters

---

Micro-filters must be fitted as the last element in the supply line. For specification see the section [Other Specifications \[▶ 44\]](#).

Absorption dryers are prone to oil contamination and as such the input must be fitted with an oil filter (oil < 0.01 mg/m<sup>3</sup> 99.9% removal efficiency). To protect the dryers, regardless of type, you are advised to install a water filter and an oil filter between the compressor and the dryer. Adsorption dryers may generate dust and may need extra dust filters at the output.

The output of refrigeration dryers must be fed through a carbon activated filter.

Water filters must be fitted with automatic water drains as opposed to manual drains. The use of valve switched drains is strongly recommended. Floater switched drains have a tendency to become jammed and hence require regular maintenance.

If you are particularly concerned about oil contamination in the air supply then you must consider using a submicron filter followed by an activated charcoal filter as this combination is particularly effective in removing oil.

## 8.4 Liquid Nitrogen Requirements

---

### Purity of Liquid Nitrogen

Bruker has no specification for the quality of the liquid nitrogen. Inhouse we are using a purity of >99.9 %. There are no field gradients known because of the para-magnetism of oxygen. Nitrogen and oxygen are fully mixable over the whole concentration range.

Liquid nitrogen has a lower boiling point at -196 °C (77 K) than oxygen's -183 °C (90 K), and vessels containing liquid nitrogen can condense oxygen from air. When most of the nitrogen has evaporated from such a vessel, there is a risk that liquid oxygen remaining can react violently with organic material. Conversely, liquid nitrogen or liquid air can be oxygen-enriched by letting it stand in open air; atmospheric oxygen dissolves in it, while nitrogen evaporates preferentially.

A few percent of oxygen in the liquid nitrogen vessel will only give a minor temperature increase of the boiling point and will thus not increase the helium loss. With the higher boiling point the amount of oxygen will increase over the time.

Small nitrogen liquefiers will achieve a nitrogen content of >98 %. When using such a quality of nitrogen it is recommended to check the content of oxygen in the nitrogen vessel regularly. To limit the oxygen content it is advisable to refill when the nitrogen vessel is at least half empty. To get rid of the oxygen completely, wait until the liquid has evaporated before refilling. Be aware when only the helium has to cool the magnet coil the boil off will be about 40 times higher.

Refer to the chapter [Safe Handling of Cryogenic Substances \[▶ 15\]](#) for important information on the safe handling of liquid nitrogen.

## 8.5 Cooling Water

---

If the system is equipped with the CryoProbe option and the compressor is water cooled, then cooling water is also needed to remove the ca. 7.5 kW of heat output from the water-cooled type helium compressor used in conjunction with the CryoProbe. The cooling water requirements for the CryoProbe system are found in the chapter [Helium Compressor - Indoor Water Cooled \[▶ 66\]](#).

## 8.6 Lighting

Operation is most convenient when the computer monitor(s) may be viewed under subdued lighting. However, normal office lighting will be needed in other areas of the laboratory. The most convenient arrangement is to have separately switchable lights using standard light bulbs. Make sure that reflections from strong artificial light do not fall upon the monitor screen. Care should also be taken to minimize reflections from sources such as windows.

- Do not direct spotlights toward the magnet; this could change the surface temperature.
- Consideration should be given to the relative placement of lights to the air conditioning inputs, which mostly contain the temperature sensors for the air conditioners. Otherwise the switching of lights might result in a system over-reaction and a considerable temperature change.
- Neon lights, choke ballast, and electronic ballast are generally not recommended within a radius of 2 meters from the magnet. LED with DC current are generally not a problem within this range.
- Lights should not be located directly above the magnets, as it may not be possible to service the lights.

## 8.7 HVAC (Heating Ventilation Air Conditioning)

Constant air pressure, temperature and humidity is crucial for high performance operation. Ideally, an absolute room temperature of between 17-25°C should be kept.

**Room should not fluctuate** more than +/- 0.5°C per 24 hours near the magnet or cabinets. Even with small changes within this narrow range, it is essential that these are random and there is **no periodicity of temperature changes**.

Air drafts, particularly those created from air conditioning or heating systems, can have negative effects on the magnet, thus the location and orientation of air-diffusers must prevent the air from blowing towards the magnet and spectrometer cabinet. If possible, it is recommended to have the exhaust (air-return) closer to the NMR spectrometer equipment (AVANCE console, UPS, CryoCooling unit, BCU-I) that releases most of the heat output into the space. This would help with removing the heat closer to its sources and ultimately help with the overall temperature stability in the room.

### Gradients

The temperature stability guidelines above are essential for a given point in proximity to the magnet or console. Absolute temperature values at different elevations in the room can vary by a much greater tolerance.



**Note:** When NMR Lock is on and when Autoshim is used, the room should not fluctuate more than +/- 1.5 °C per 24 hours.

The maximum humidity in the lab depends on the room temperature. There are parts on or near the NMR spectrometer and the magnet system (like the nitrogen heat exchangers) which have temperatures of 13...14°C. When the room temperature is 25°C, with a humidity of 80 %, the dew point of this air is at 21.3°C. This means condensation may build up at the heat exchangers and other parts like temperature units or shim coils.

Therefore we recommend a **dew point of 11°C** in the laboratory (for the magnet parts) to avoid condensation at the location of cold parts. With a laboratory temperature of 17°C the humidity can rise up to 67.7 % and with 25°C it will be only 41.4 %.

Temperature in the NMR laboratory	Maximum humidity for a dew point of			
	11 °C	12 °C	13 °C	14 °C
17 °C	67.7 %	72.4 %	77.3 %	82.5 %
18 °C	63.6 %	68.0 %	72.6 %	77.5 %
19 °C	59.7 %	63.8 %	68.2 %	72.8 %
20 °C	56.1 %	60.0 %	64.1 %	68.4 %
21 °C	52.8 %	56.4 %	60.2 %	64.3 %
22 °C	49.7 %	53.0 %	56.7 %	60.5 %
23 °C	46.7 %	49.9 %	53.3 %	56.9 %
24 °C	44.0 %	47.0 %	50.2 %	53.6 %
25 °C	41.4 %	44.3 %	47.3 %	50.5 %

Table 8.3: Maximum Humidity in the NMR Laboratory

Conditions other than these may warrant the installation of an air conditioner with appropriate humidity controls.

### 8.7.1 Heat Dissipation into the Room

Most of the heat dissipated into the room is generated by the system electronics. The magnet itself does not dissipate any heat. The following table details the heat dissipation into the room:

System	Heat Dissipation into Room
AVANCE TwoBay (with 3 channels & BCU-I)	2.5 kW
AVANCE TwoBay (configured for solids)	5.0 kW
BMPC II (high frequency systems only)	1.25 kW
BCU-I, BCU-II	BCU-I: 0.5 kW BCU-II: 2.4 kW
CryoCooling Unit	0.8 kW
He Compressor CryoProbe - indoor water-cooled	0.5 kW - residual
He Compressor CryoProbe - indoor air-cooled	8.5 kW
He Compressor CryoProbe - outdoor air-cooled	8.5 kW

Table 8.4: Heat Dissipation into the Room by Typical AVANCE Systems

### 8.7.2 System Stability

#### Air Temperature

The heat dissipation of the magnet system is constant over time. It is essential to minimize or avoid short term oscillations of the HVAC system, and provide a continuous slow flow of air that in turn reduces the speed of any temperature changes. It is recommended to have a continuous and slow exchange of air in the laboratory, hence minimizing fluctuations.

### Air Diffuser and Return Ducts

- Avoid any air drafts in the room, especially towards the magnet or system electronics.
- Use low velocity diffusers or a perforated duct (e.g. a duct sock).
- In order to remove heat directly from the source it is recommended placing the air return ducts closer to the rear side of the system electronics.

### Atmospheric Pressure Changes

Rapid changes in the temperature may result in atmospheric pressure changes. High atmospheric pressure could reduce the helium boil off if the magnet cryostat is not equipped with an electronic atmospheric pressure device. The boil-off rate could be even lower than the minimum value which could be measured by the flow meter. **Electronic Atmospheric Pressure Devices (EAPD)**, which, for example, holds the pressure at 1030 HPa, stabilize field drift and helium boil-off when changes in atmospheric pressure occur.

The atmospheric pressure device is included as standard with all Ultra-High Field magnet systems.

## 8.8 Emergency Ventilation During Installation and Quenches

Due to the large amount of liquid helium contained in the magnet, an emergency exhaust system may be required to prevent O<sub>2</sub> depletion during a magnet quench.

Likewise, during the installation, refilling and cooling of superconducting magnets, large volumes of nitrogen or helium gases may be generated under certain conditions. Although these gases are inert, if generated in large enough quantities, they can displace the oxygen in the room causing potential danger of suffocation.

The following table lists the amount of liquid helium and helium gas after a quench:

Magnet Type	Amount Liquid Helium (liters)	Helium Gas After a Quench (m <sup>3</sup> )
Ascend 850	450	333

Table 8.5: Helium Gas After a Quench

Regarding the emergency gas exhaust, important considerations include, but are not limited to, the following:

- **Amount of liquid helium:** In case of a quench, the liquid transforms into gas and expands by a factor of 740. The total amount of evaporated helium gas in case of a quench will be ca. 333 m<sup>3</sup> (11,800 ft<sup>3</sup>).
- **Maximum helium gas flow:** The maximum flow of helium gas is calculated on the assumption that half of the volume of liquid evaporates in 1 minute, thus the maximum flow would be 166.5 m<sup>3</sup>/min (5,900 ft<sup>3</sup>/min). The gas should be removed from the room immediately through an emergency exhaust system.
- **O<sub>2</sub> level sensors:** Oxygen level sensors are required to detect low O<sub>2</sub> levels within the laboratory for each system. One sensor is needed above the magnet for detecting low O<sub>2</sub> levels due to He gas exhaust in case of a quench or during He fills. An additional sensor is needed close to the floor for detecting low O<sub>2</sub> levels due to N<sub>2</sub> gas exhaust during magnet cooling or regular N<sub>2</sub> fills. In case of placing the magnet inside a pit, a third sensor is needed inside a pit to detect low O<sub>2</sub> levels from N<sub>2</sub> gas.

### 8.8.1 Emergency Exhaust Solutions

---

In many cases doors and windows will provide sufficient ventilation in larger rooms. It is important to compare the volume of helium gas that would be released after a quench and the space volume of the NMR magnet room, in order to determine the optimum and practical solution for emergency ventilation. In general it is recommended that an emergency exhaust system be installed in smaller rooms, or rooms not connected to the outside. The following exhaust solutions are recommended:

#### Passive Exhaust

This system is based on louvers in the ceiling, or upper parts of outside walls, that open up due to the pressure of helium gas.

#### Active Exhaust

In addition, an active system based on a purge fan and exhaust duct close to the ceiling is recommended. This way, adequate exhaust of cryogenic gases will be provided not only during a quench, but also during the initial cooling of the magnet and regular cryogen refills.

Normally it is sufficient to operate this fan manually, as the probability of an unattended quench after the installation is rather low.

If desired, this fan can be operated with an automatic switch:

- It may be connected to the O<sub>2</sub> sensors so it turns on automatically when the O<sub>2</sub> level drops below the safety set point.
- It should be installed in addition to a manual switch.
- Measures should be taken to prevent it from being turned on during a fire.

#### Quench Pipes

This solution may be needed as a **last resort solution** when the laboratory is small and **any of the other options are not sufficient** to ensure safety after a magnet quench.

This solution is based on a pipe connected directly to the magnet, which is then routed to the outside of the building. It is important to note the following:

- The helium exhaust from the magnet should be vented directly to the outside of the building.
- The ducts should have sufficient diameter to avoid excessive pressure build-up due to the flow impedance of the duct.
- The location of the exit end of the duct must not be accessible to anyone other than service personnel. In addition the exit opening should be protected from the ingress of rain, snow, animals, etc.
- It is also essential that any gas which vents from the exhaust duct cannot be drawn into the air conditioning or ventilation system intakes. The location of the duct's output should be carefully sited to prevent this from happening during any adverse atmospheric conditions and winds.
- Insulation of exhaust piping should also be provided to prevent cold burns and O<sub>2</sub> condensation during a quench.



Please contact Bruker if the implementation of quench pipes is planned!

---

## Pits

When a magnet is installed in a pit, it is important to ensure there is continuous air-flow (exhaust) within the pit. This is done to prevent any buildup of nitrogen gas in the confines of the pit. A low exhaust and an additional oxygen sensor down in the pit are recommended. Additional emergency ventilation may also be necessary and the oxygen sensor mounted in the pit should trigger an increased rate of exhaust.

## Exhaust for Ceiling Soffits

A soffit is a hole that has been cut in the ceiling to facilitate cryogen fills and/or the magnet installation. Though it is not required to install ventilation in a soffit, it is important to understand that the soffit will be the first area to fill up with helium gas during a quench or during a helium fill. It is important to elicit extra caution in this case.

A passive louver or an exhaust duct with fan are practical solutions when soffits are used. This will prolong the cycle of the magnet between rebuilds, by preventing helium gas build up in the soffit during refills.

## Air Conditioning as an Exhaust

It is recommended that the air conditioning system be adequate to dissipate the sudden gas buildup during a quench. In addition the air conditioning must have a safety feature which **draws all the air out** of the room and **brings fresh air** in during a quench, rather than just recirculating the old air through the system. The air conditioning system could, for example, be connected to an oxygen level sensor.

Please contact Bruker for further information on exhaust solutions.

## 8.9 Fire Detection System and Fire Extinguishers

---

Rooms containing NMR magnets should be equipped with **temperature sensors** for fire detection. These must respond *only* to a sudden rise of temperature, and not be triggered by a quench (sudden drop of temperature).

Optical smoke detectors cannot discriminate between smoke from a fire and fog from either a helium refill or caused by a quench, so these may not be used. Combined **heat and smoke detectors** are recommended instead.

**Fire extinguishers** in the vicinity of the magnet room must be **non-magnetic** (stainless steel or aluminum). It is the obligation of the customer to inform the local fire department about the dangers of magnetic fields. These magnets stay at field for a long time even in a most blazing fire!

**Ceiling sprinkler heads** should be made of metal instead of glass. A quench could falsely trigger the alcohol-filled glass vials, which can shatter in the presence of cold helium gas. Sprinklers should not be located directly over the magnet.

Any sprinkler lines or other metal pipes located above the magnet should be thermally-insulated to prevent O<sub>2</sub> condensation or water freezing in the line from the large amount of cold He gas following a magnet quench.

A **pre-action sprinkler system** is recommended, as it is not loaded with water, but is activated through an interlock mechanism enabling the water to fill the lines in case of a fire.



# 9 Floor Plan

## 9.1 Magnet Location

When locating the magnet, certain considerations must be made with regards to the laboratory environment:

- To increase magnet homogeneity, the magnet should be located away from permanent iron structures such as support beams in walls and floors. Reference: [Electromagnetic Interference \[ 35\]](#).
- To increase temperature stability, the magnet should not be placed in direct sunlight or near any artificial heat source. The magnet should also not be placed under or in close proximity to air-vents or in an area that experiences air drafts. Air should not be blown directly down or towards the NMR magnet.
- When possible, avoid a situation where a significant stray field ( $>5$  G / 0.5 mT) extends into adjacent rooms.
- There should be free access to the magnet from all sides.

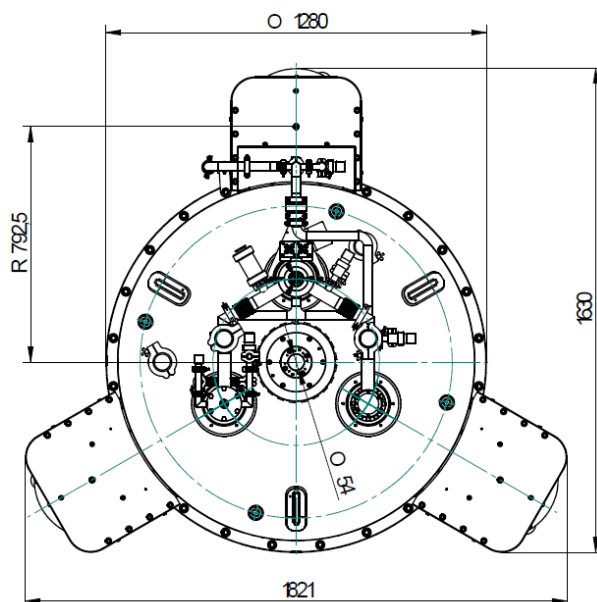

Figure 9.1: Top View of the Ascend 850 Magnet

## 9.2 Dimensions and Mass of Equipment

The floor of the NMR laboratory must be sufficiently strong to support the magnet, the spectrometer, and other ancillary equipment. The following tables provide the dimensions and weights of equipment, and the footprint and weight of magnets (filled with cryogens and including stand). The assembly of the magnet system, the magnet energization and refills with liquid helium require additional ceiling height.

Component	Width (m)	Depth (m)	Height (m)	Weight (kg)
AVANCE TwoBay	1.31	0.83	1.55	454
Table / Workstation	1.20	1.00	0.75	68
BCU-I	0.50	0.55	0.48	46
BCU-II	0.55	0.59	0.74	74
BMPC II	0.70	0.85	1.70	254
For the CryoProbe option refer to <a href="#">CryoProbe and Other Accessories [ 63]</a> .				

Table 9.1: Dimensions and Weights of NMR Equipment

## 9.3 Floor Load

The floor must be sufficiently strong to support the mass of the equipment, plus the weight of any installation devices, e.g. hoists etc. The floor must also be as rigid as possible to reduce the effects of vibration.

The overall floor load may be calculated from the total magnet weight distributed over the overall footprint of the magnet.

Component	Width (m)	Depth (m)	Height (m)	Weight (kg)
Ascend 850	1.83	1.63	3.16	~3,500

Table 9.2: Dimensions and Weights of Magnet

The magnet is supported by a total of 9 small pads (3 pads per post), each pad having a diameter of 66 mm. The maximum point load may be calculated by the total weight of the magnet distributed over the total contact area of the supporting pads.

## 9.4 Magnet Slab

In larger buildings, an isolated magnet slab may be used to separate the magnet from the rest of the floor and building. This may reduce vibrations that are transmitted to the magnet from the building (electromechanical equipment, HVAC, personnel, etc.). The slab must be large and strong enough to safely support the load of the magnet.

The recommended dimensions for a possible magnet slab are as follows:

Magnet Type	Length (m)	Width (m)	Minimum Depth (m)
Ascend 850	3.6	3.6	0.30

Table 9.3: Recommended Magnet Slab Dimensions

**NOTE:** These dimensions are guidelines, not specifications, and remain subject to approval by the project's structural engineer.

**Reinforcement:** It is recommended to use non-magnetic reinforcement (e.g. fiberglass, or non-magnetic stainless steel).

An isolated slab may not be necessary if the structure contains no sources of vibrations, or if the foundation is on bedrock. In this case, it is still recommended to perform a vibration analysis. Please consult with Bruker regarding the magnet slab and to arrange for analysis.

Refer to [Vibrations \[ 31\]](#) for more information on vibration isolation and site analysis.

## 9.5 Floor Types

Generally a **liquid nitrogen resistant floor material** must be used, such as PVC or wood that has been painted or varnished. Unfinished wood must not be used as this will absorb liquid nitrogen. This also implies that wood floors must be regularly maintained to help prevent absorption.

Many of the system components contain highly sensitive electronic devices that must be protected from **Electrostatic Discharge** (ESD) by proper floor covering and grounding practices.

To prevent ESD damage in the magnet room, the system must be installed on an ESD resistant flooring such as vinyl, and properly grounded. One of the most important characteristics of an **ESD resistant floor** is its ability to conduct charges to ground. The second most important aspect is its **anti-static property**.

### 9.6 Magnet Pits

---

When the magnet must be sited in an existing magnet pit, pay attention to the following:

- Special rigging equipment and a temporary platform to support and lower magnet inside the pit.
- Continuous ventilation and emergency exhaust inside the pit (please refer to special notes related to pits in sections *HVAC (Heating Ventilation Air Conditioning)* [▶ 49] and *Emergency Ventilation During Installation and Quenches* [▶ 51]).
- Magnet refills and access for transport dewars.
- Cable lengths.
- Siting the BCU-I or BCU-II cooling unit.
- Siting the CryoPlatform™.

Consult your local Bruker Installation Engineer for details.

### 9.7 Magnet Platform

---

The Ascend magnet is a compact magnet, which does not necessarily require a platform. A rolling ladder will be sufficient. The ladder must be non-magnetic and the height of the top step should be ~1.70 meters from the floor.

### 9.8 Magnet Pump Line

---

The magnet pump line connects the cryostat to the pumps inside the BMPC II cabinet. It is custom-made from stainless steel to fit site requirements. Usually, it is placed on the floor:

- The preferred route is to keep the pump line at floor level. The pump line runs down to the floor near the magnet stand, and then continues to the BMPC II. A 15 x 15 cm trench would be sufficient to conceal the pump line and sensor cable.
- It is always important to route the line such that tripping hazards and obstructions are avoided, and to protect the physical integrity of the pump line at all times.

## 9.9 Maximum Field Strengths for NMR Equipment

Once the location of the magnet has been decided, it is time to determine where the remainder of the equipment will be placed. Protection of motors and electronics from magnetic stray fields is crucial.

Unit	Maximum Field Strength
AVANCE cabinet	1.0 mT (10 G) line
BCU-I, BCU-II	5.0 mT (50 G) - max. 2.7m from magnet center
LCD computer monitor*	1.0 mT (10 G)
Computers e.g. NMR workstation, PC	0.5 mT (5 G)
Printer, plotter	0.5 mT (5 G)
BMPC II	0.5 mT (5 G)
CryoProbe system components (e.g. He compressor, He steel cylinder and its transport path)	0.5 mT (5 G)
CryoCooling unit	5.0 mT (50 G)
Gas cylinders	0.5 mT (5 G)
Heavy metal office furniture e.g. filing cabinet**	0.5 mT (5 G) - not recommended in magnet room
Movable metal chair	Not recommended in magnet room
* The working place for personnel should be outside the 0.5 mT (5 G) line. An additional LCD monitor and keyboard can be located at the 1.0 mT (10 G) line for probe adjustments etc.	
** Use wooden furniture if access during critical measurements is required.	

Table 9.4: Maximum Field Strength for NMR Equipment

## 9.10 Cabinet Position

The various units within the AVANCE™ cabinet, especially the acquisition computer, must be kept at a minimum distance from the magnet. Protection of the acquisition computer and digital electronics from the magnet's stray field is best achieved by positioning the cabinet so that the acquisition computer is no closer than the 1.0 mT (10 G) line. Any ancillary cabinets such as microimaging must also be placed outside the 1.0 mT (10 G) line. To allow adequate ventilation for the cabinet, it must be positioned no closer than 30 cm from the back of the cabinet to any walls. For service access to the rear, there must be sufficient space for the cabinet to be pulled out from the wall. For ease of cabling, locate electrical outlets and compressed air supply close to the rear of the cabinet.

### 9.11 Worktable Position

---

Magnetic storage devices are sensitive to the stray field and attention must be given to their position relative to the magnet.

- The workstation and additional disks, are normally placed on the worktable, and should not be exposed to fields greater than 1.0 mT (10 G).
- For convenience of operation, no direct light should fall on the LCD panel, nor should there be a strong light source at the back of the panel. A separate dimmer or at least partial switching is recommended for the lights in the worktable area.

### 9.12 Service Access Requirements

---

The following recommendations will ensure that there is sufficient space for accessing the system, as well as providing adequate ventilation:

- Ventilation: A minimum of 30 cm must be left between the back of the cabinet and any wall to ensure proper ventilation.
- Service access - AVANCE: Sufficient space (~ 60 cm) must be left in front of the AVANCE so the cabinet may be pulled away from the wall for service. Service access to the sides is not required.
- Service access - Magnet: There must be enough space between the magnet legs and the wall such that a service person can walk all the way around the magnet. Also, when refilling the cryogen levels, large dewars must be brought close to the magnet. Ensure that the magnet room is suitably spacious to allow easy access for the dewars. If a platform is not used then there must also be enough room for a ladder. As a rule of thumb the magnet must be accessible over at least half of its circumference for a radial distance of 2 m from the side of the magnet and be no closer than 0.8 m to the nearest wall.

The following are miscellaneous, but important things to think about when creating a workable floor plan:

- For ease of cabling, locate electrical outlets and compressed air supply close to the rear of the cabinet and by the magnet.
- The door to the magnet room must be easily accessible from all parts of the room. It is advantageous to have the doors located so that traffic through the room does not approach the magnet. The door to the magnet room should swing out to allow for a rapid and easy exit in case of an overpressure from cryogenic gases.
- As a rule gas cylinders must be stored outside the room. If for any reason they must be placed in the magnet room located as far away from the magnet as possible and secured properly to a wall well outside the 5 Gauss.
- Ensure that convenient and safe pathways are available so that cryogen transport dewars can easily be moved into and out of the magnet room. This includes making sure that the cryogen dewars do not run over cabling, and that the equipment/furniture is located to allow for access.
- Make provision for sample/solvent preparation and storage space, documentation storage space, personal computers, printer/plotter tables, workstations etc.
- Under no circumstances should movable office chairs made of magnetic material be used in the laboratory.
- Make provision for installing a telephone and lines for, e.g. Internet access. It is most convenient if the operator can use the phone while sitting at the spectrometer worktable.

Finally, before a final layout is decided, consider future equipment that may need to be installed. Remember that once installed, the magnet must not be moved.

## 9.13 Layout Examples

The following layout example includes the equipment and utilities. A description of each of the NMR system components is presented in the chapter [System Components \[ 19\]](#), while the details regarding the utility requirements are presented in the chapter [Utility Requirements \[ 41\]](#).

The next table refers to the numbered items in the sample site layout that follow.

Device	No.	International	America	Purpose/Comments
UPS	#1	230V, 50/60Hz 50A 1-Ph	208V, 60Hz, 60A, 1-Ph	Disconnect, on emergency power.
BMPC II	#2	230V, 50/60Hz, 16A 1-Ph	208V, 60Hz, 20A, 1-Ph, L6-20R	For installation and service.
	#3	230V, 50/60Hz, 16A 1-Ph	208V, 60Hz, 20A, 1-Ph, L6-20R	
	#4	J-box, 230V, 32A, 1Ph	J-box 208V, 30A 1-Ph	Conduit to power the AVANCE from the BMPC II.
	#5	J-box, 230V, 16A, 1Ph	J-box 208V, 20A 1-Ph	Conduit to power the CryoCooling unit from BMPC II.
	#6	Analog fax modem line.		
AVANCE	#7	Receptacle termination of wire-in conduit coming from J-box, 230V, 32A	L6-30R termination of wire-in conduit coming from J-box, 208V, 30A	Power the AVANCE from the BMPC II.
	#8	230V, 50/60Hz, 30A, 1-Ph	208V, 60Hz, 30A, 1-Ph, L6-30R	For back-up.
	#9	Regulated compressed gas 6.9 bar (100 psi).		
BCU-I or BCU-II	#10	230V, 50/60Hz, 16A 1-Ph	110V, 60Hz, 20A	On separate UPS.
Cryo Cooling Unit	#11	Receptacle termination of wire-in conduit coming from J-box, 230V, 16A	L6-20R termination of wire-in conduit coming from J-box, 208V, 20A	Power the CryoCooling unit from the BMPC II.
	#12	230V, 50/60Hz, 16A, 1-Ph	208V, 60Hz, 20A, 1-Ph, L6-20R	For back-up.
	#13	Regulated compressed gas 4.1 bar (60 psi)		
He Compressor	#14	400V, 50Hz, 30A (fused), 3-Ph or 480V, 60Hz, 30A (fused), 3-Ph	208V, 60Hz, 60A (fused), 3-Ph	Disconnect, on emergency power.
Workstation	#15	230V, 50/60Hz, 16A, 1-Ph	110V, 20A, 1-Ph	On separate UPS.
	#16	Telephone port		
	#17	Data port		
Imaging Accessory	#18	230, 50/60Hz, 30A, 1-Ph	208V, 60Hz, 30A, 1-Ph	Optional cabinet.

Table 9.5: Utility Requirements

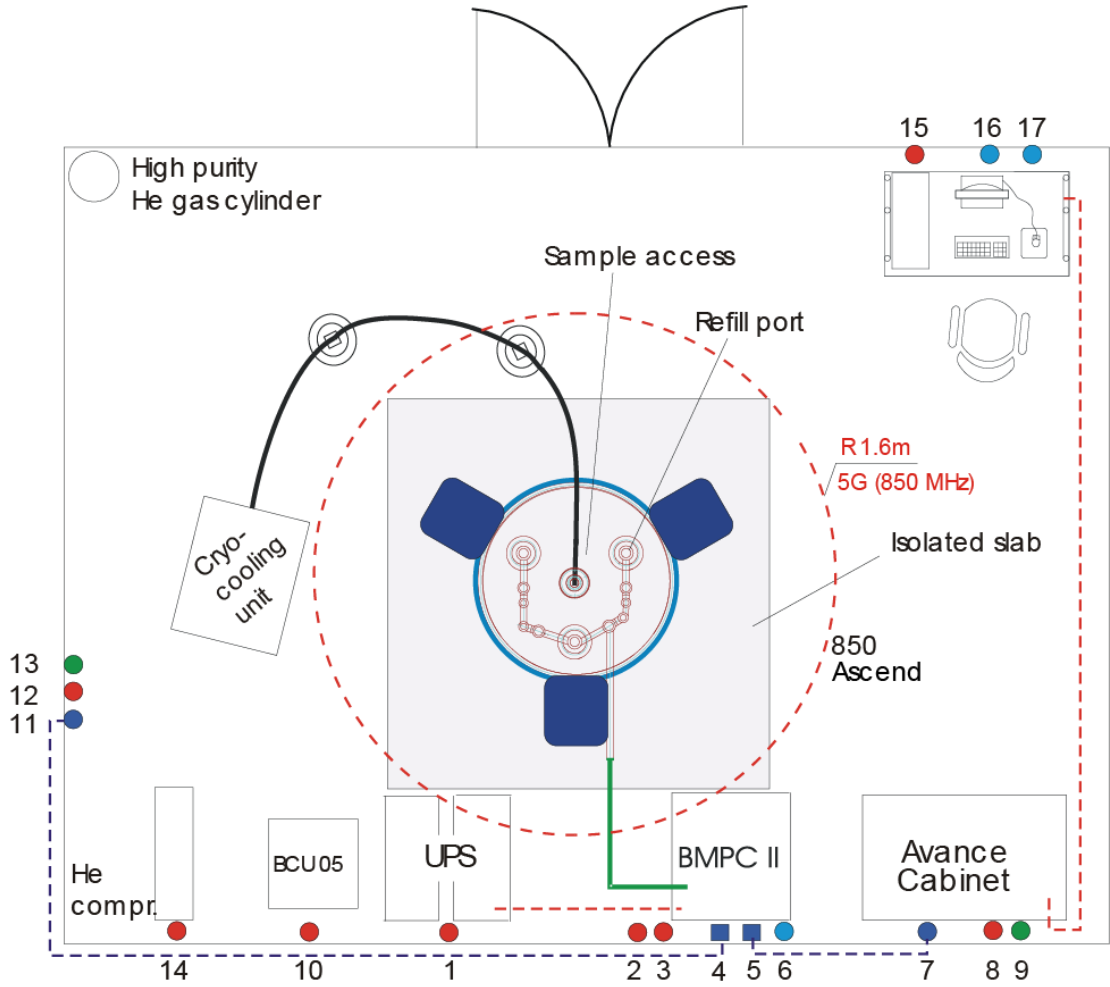

Figure 9.2: Ascend 850 NMR Layout Example

# 10 CryoProbe and Other Accessories

The CryoProbe accessory for the AVANCE™ Series NMR Spectrometers offers dramatic increases in signal to noise ratio (S/N) by reducing the operating temperature of the NMR coil assembly and the preamplifier.

The CryoProbe accessory consists of two major components: the CryoProbe and the CryoPlatform. The CryoProbe is similar to a standard probe, however contains cryogenically cooled RF coil and electronics. The CryoPlatform, which provides cryogenic cooling for the CryoProbe, is made up of:

- CryoCooling Unit with control electronics.
- Helium Compressor (along with any associated cooling equipment).
- Helium Gas Cylinder (for purging of the CryoProbe).
- Helium transfer lines and transfer line support.

The CryoCooling Unit must be sited adjacent to the magnet, whereas the Helium Compressor and Helium Gas Cylinder may be sited remotely. The first step in the site planning involves review of the magnet area to determine if floor space is available to accommodate the CryoCooling Unit. The CryoCooling Unit is optimally located level with the magnet. Other configurations, such as magnet pits that can not accommodate the CryoCooling Unit, require special consideration.

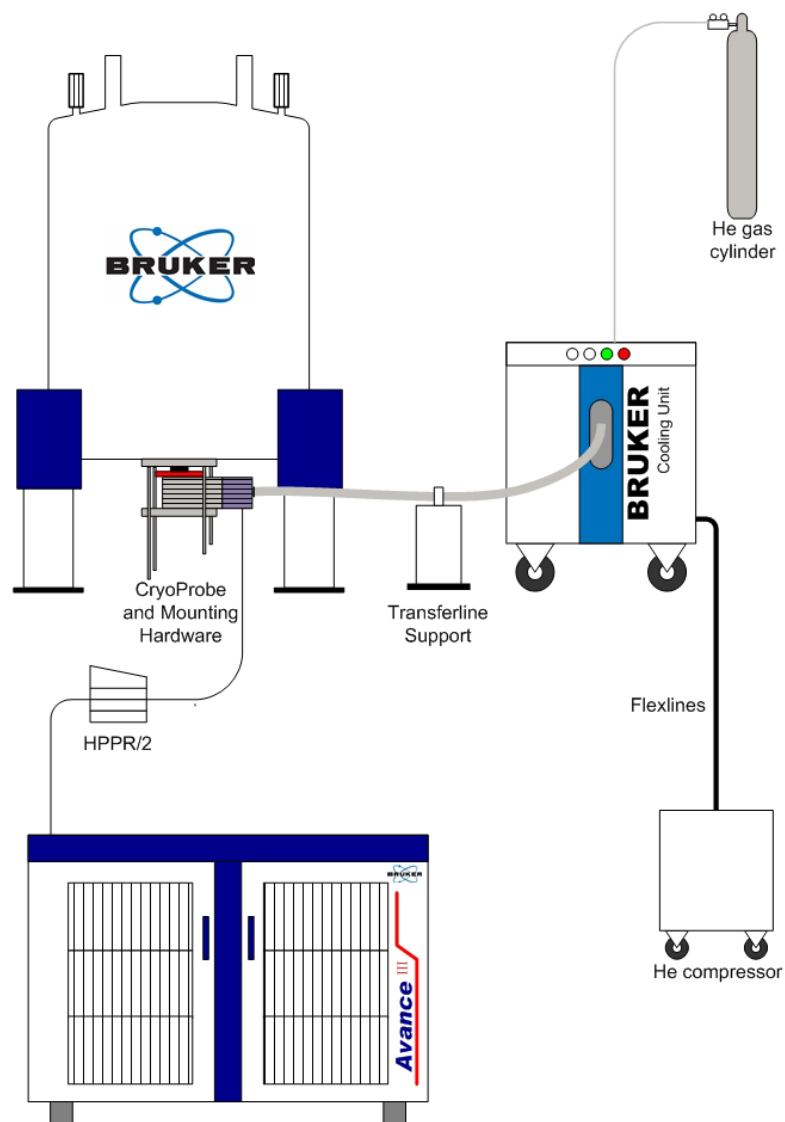

Figure 10.1: CryoProbe System Overview

Refer to the layout examples for more information.

## 10.1 CryoCooling Unit

The CryoCooling Unit is installed adjacent to the magnet outside the 50 Gauss (5 mT) line. The shim cable must be 180° from the CryoProbe front plate. The shim stack may be rotated if necessary.

Dimensions:	Width: 68 cm Depth: 89 cm Height: 96 cm
Weight:	400 kg
Voltage: Required external fuse upstream:	230 V AC +/- 10%, 1 phase, 50-60 Hz. T 10 A (T = time-lag fuse)
Power consumption:	Peak 0.8 kW Average 0.5 kW (systems produced before June 2005: peak power of 1.5 kW)
Acoustic noise:	Maximum 61 dB(A) 2 meters distant
Maximum room ambient temperature:	30°C. No operation above this temperature is approved.
Helium gas supply:	A high purity helium (He) gas cylinder (6 N = 99.9999% or better, maximum impurity concentration 1 ppm).
Compressed air or nitrogen supply:	With a pressure of > or = to 4.5 bar.
Position:	Outside 50 Gauss (5 mT) stray field.

Table 10.1: CryoCooling Unit Specifications

## 10.2 Helium Compressors

The next step in the site planning for a CryoProbe accessory involves determining the type and location of the helium compressor. Since the helium compressor generates a considerable amount of heat (7.5 kW average, 8.5 kW peak), it must be cooled to prevent overheating. Bruker offers both water cooled and air cooled helium compressors. In either case, placing the compressor in a remote room (allowing He gas flex lines up to 20 m to reach the CryoCooling unit) or an enclosure will keep the noise of the unit out of your laboratory. Outdoor helium compressors may be sited at increased distances allowing He gas lines up to 40 m to reach the CryoCooling Unit.

### 10.2.1 Available Models

Three models of helium compressors are currently available. All the compressors must be sited outside the 5 Gauss (0.5 mT) line, generate the same amount of heat (7.5 kW average) and have the same power requirements (3 Phase, 208 V). The correct helium compressor for your laboratory may be determined based on the desired location for the unit (indoor, outdoor, and distance from the CryoCooling Unit) and the availability of a chilled water supply. Helium transfer lines connect the helium compressor to the CryoCooling unit and are available in several different lengths as shown below.

## 10.2.1.1 Helium Compressor - Indoor Water Cooled

- Requires chilled water source (supplied by customer) with a flow and temperature within the specified admissible ranges shown in the plots below. It is important that not only the temperature stays below the maximum temperature threshold but also the flow is not greater than the upper threshold shown. Caution: Do not use demineralized or deionized water.
- The water supply and return lines to the He compressor should be fitted with temperature, flow, and pressure gauges that are visible. The water hoses from the water lines to the He compressor should be 3/4" in size. These hoses are not supplied with the CryoProbe system, and are to be provided by the customer.
- It is recommended to isolate the cooling water loop for the He compressor from the building water system by using either a refrigerated chiller or a water-water heat exchanger. If building cooling water is not available, an air-cooled indoor or outdoor chiller may be used.

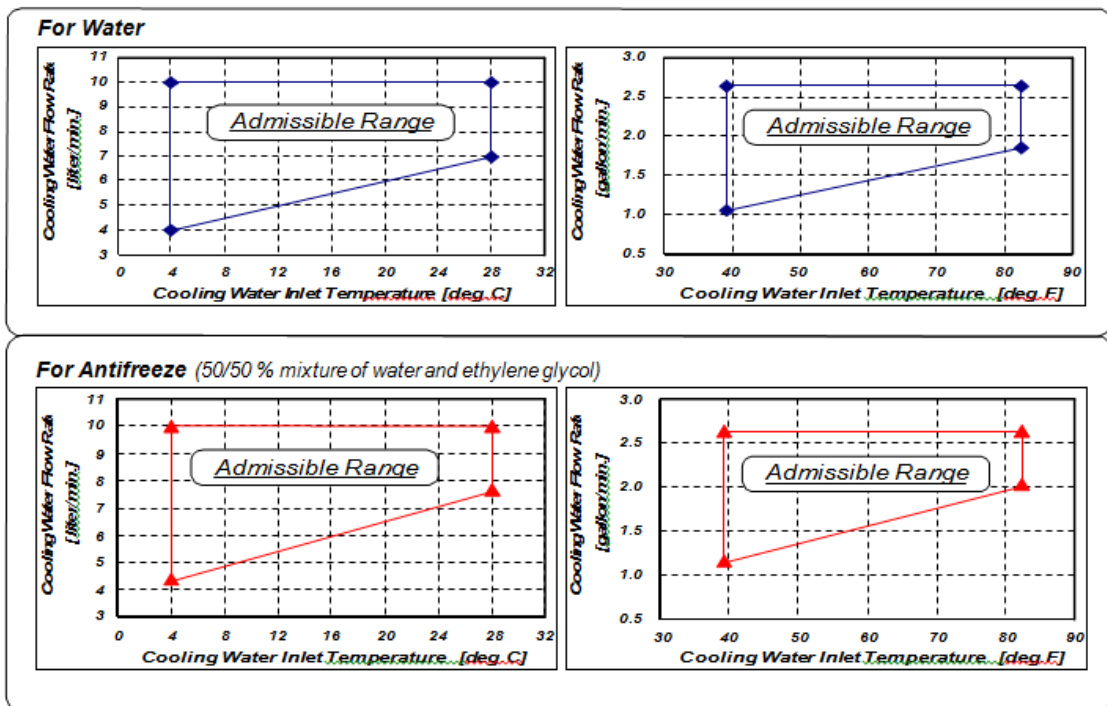

Figure 10.2: Admissible Ranges for the Temperature and Flow of the Cooling Water.

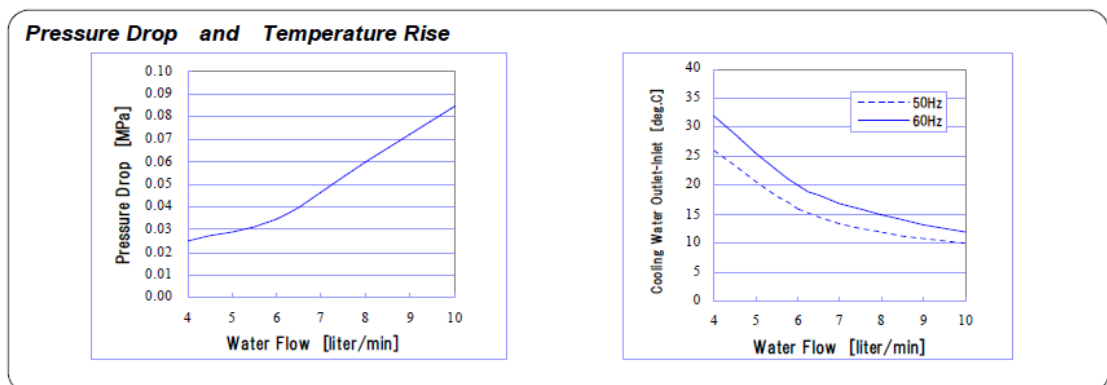
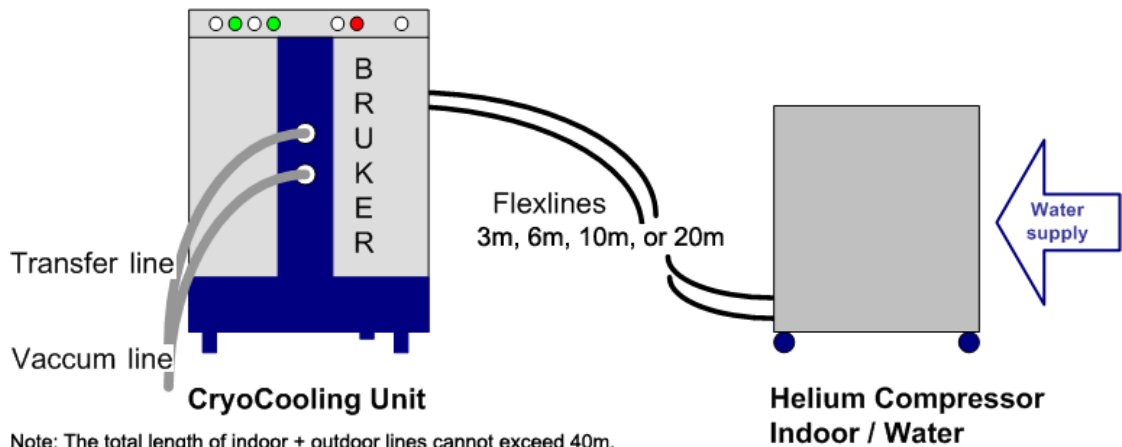

Figure 10.3: Cooling Water Typical Flow Characteristics

<b>Characteristics</b>	Inlet Temperature Range [°C] (°F)	[4.0 ~ 28.0] (39.2 ~ 82.4)
	Inlet Pressure Range [MPa] (psig)	[0.10 ~ 0.69] (14.5 ~ 100)
	Flow Rate [liter/min.] (gallon/min.)	[4.0 ~ 10.0] (1.1 ~ 2.6)
	Pressure Drop [MPa] (psig)	[0.025 ~ 0.085] (3.55 ~ 12.1)
	Heat Output [kW ] (BTU/Hr) into the water (residual of 0.5 kW into air)	<Steady State> [< 6.5] (< 22180) for 50Hz [< 7.5] (< 25590) for 60Hz <Maximum> [< 7.2] (< 24570) for 50Hz [< 8.3] (< 28320) for 60Hz
<b>Quality</b>	pH Value	6.5 to 8.2 at 25 °C (77 °F)
	Electrical Conductivity	< 80 mS / m
	Chloride Ion	< 200 mg/liter
	Sulfate Ion	< 200 mg/liter
	M-Alkalinity	< 100 mg/liter
	Total Hardness	< 200 mg/liter
	Calcium Hardness	< 150 mg/liter
	Ionic Silica	< 50 mg/liter
	Iron	< 1.0 mg/liter
	Copper	< 0.3 mg/liter
	Sulfide Ion	None, Not detectable
	Ammonium ion	< 1.0 mg/liter
	Residual Chlorine	< 0.3 mg/liter
	Free Carbon Dioxide	< 4.0 mg/liter
	Stability Index	6.0 to 7.0
	Suspended Matter	< 10 mg/liter
	Particle Size	< 100 µm

Table 10.2: Cooling Water Specifications

- Ambient operating temperature 5–28°C.



Note: The total length of indoor + outdoor lines cannot exceed 40m.

Figure 10.4: Helium Compressor - Indoor Water Cooled

## 10.2.1.2 Helium Compressor - Indoor Air Cooled

- The room air handling system must be able to dissipate 7.5 kW of heat.
- Siting this helium compressor in the same room as the NMR is not recommended.
- Ambient operating temperature 5–28°C.

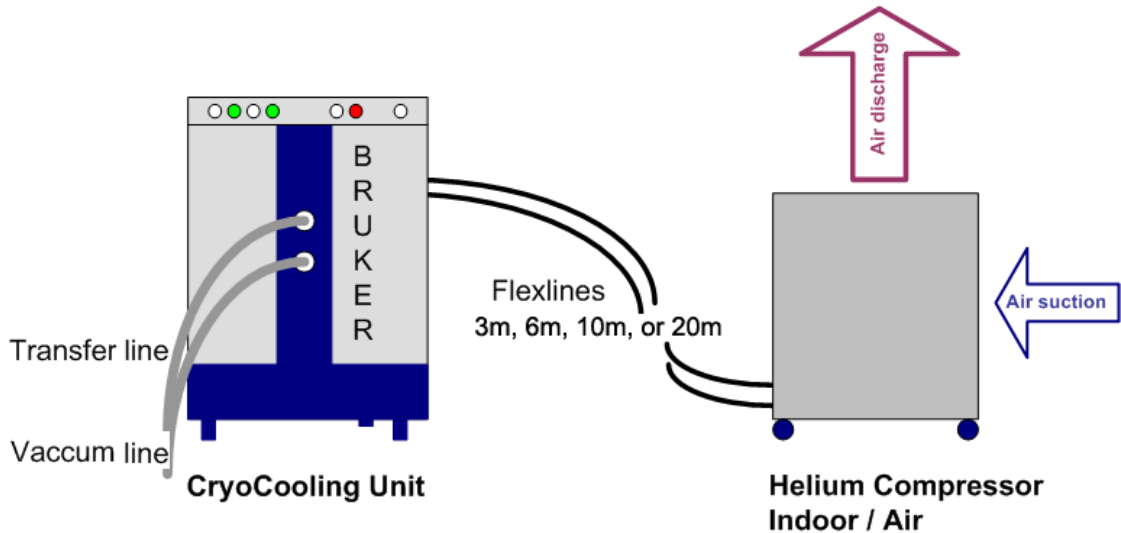

Note: The total length of indoor + outdoor lines cannot exceed 40m.

Figure 10.5: Helium Compressor - Indoor Air Cooled

## 10.2.1.3 Helium Compressor - Outdoor Air Cooled

- The Outdoor Air Cooled helium compressor consists of an Outdoor Unit and an Indoor Unit.
- The outdoor unit is specified to operate between the temperatures of –30°C to 45°C.

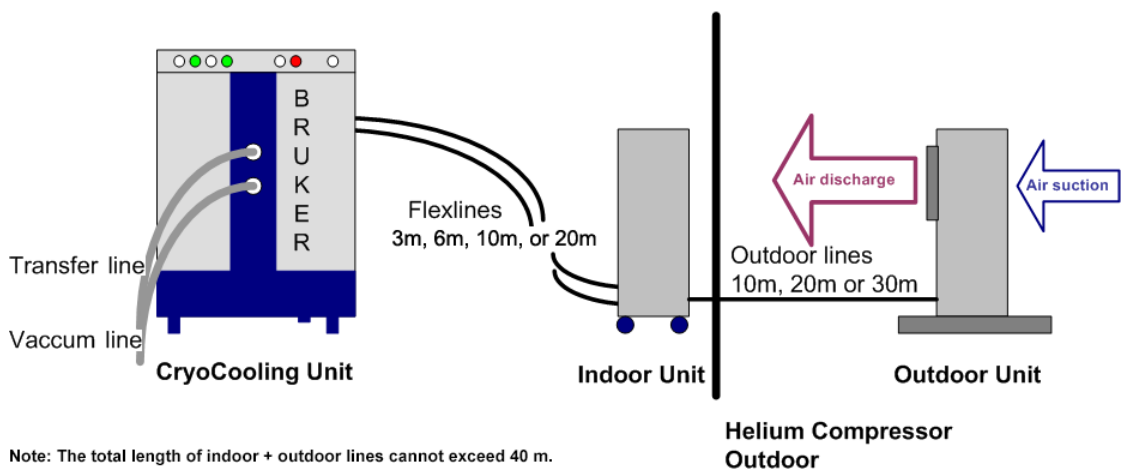

Note: The total length of indoor + outdoor lines cannot exceed 40 m.

Figure 10.6: Helium Compressor - Outdoor Air Cooled

## 10.2.2 Space Requirements and Specifications

### 10.2.2.1 Indoor Helium Compressors

The indoor helium compressors (air or water cooled) have space requirements to allow for airflow and servicing the unit. The minimum room space needed is 1.25 m (width) x 0.8 m (depth) x 0.7 m (height).

Sumitomo Type:	F-50L	F-50H	CSA-71A
Type of Compressor:	Water-cooled	Water-cooled	Air-cooled
Dimension:	Width: 45 cm Depth: 48.5 cm Height: 59.1 cm	Width: 45 cm Depth: 48.5 cm Height: 59.1 cm	Width: 55 cm Depth: 55 cm Height: 88.5 cm
Weight:	120 kg	120 kg	140 kg
Voltage:	3 x 200 V @ 60 Hz	3 x 400 V (380, 400, 415 @ 50 Hz, or 460, 480 @ 60 Hz)	3 x 200 V @ 50/60 Hz US no plug supplied
Mainly delivered to:	USA/CA/JP	EU/CH	USA/CA/JP
Operating Current:	26 A	13 A	25 A
Minimum Circuit Ampacity:	35 A	17 A	35 A
Maximum Fuse Size:	60 A	30 A	60 A
Compressor LRA:	160 A	75 A	100 A
Power Requirements Minimum: Recommended:	9 kVA 12 kVA	9 kVA 12 kVA	9 kVA 12 kVA
Power Consumption Cool Down max. 50/60 Hz: Steady State max. 50/60 Hz:	7.2/8.3 kW 6.5/7.5 kW	7.2/8.3 kW 6.5/7.5 kW	7.2/8.3 kW 6.5/7.2 kW
Water supply to remove the heat load (cooling power > 8.3 kW):	Flow: 420 l/hour Temperature: 4-28°C Water Quality: PH 6.5-8.2 Hardness: mg[CaCo3]/l < 200 Molybdate-reactive silicate: < 50 mg/l Suspended matter: < 10 mg/l Maximum pressure: < 7 bar (100 PSI)		---
Helium Gas Supply:	A high purity helium (He) gas cylinder (6 N = 99.9999% or better, maximum impurity concentration 1 ppm).		
Acoustic Noise:	Maximum 60 dB(A), 2 meters distant.		
Ambient Operating Temperature:	5 to 28°C (41 to 82.4°F)		30°C

Table 10.3: Technical Data for Indoor Compressors

## 10.2.2.2 Outdoor Helium Compressors

The outdoor helium compressor has an outdoor and an indoor unit. Each component has space requirements for airflow and servicing.

The **indoor** component requires a space of 0.5 m (width) x 1.3 m (depth) x 1 m (height).

The **outdoor** component requires a space of 1.4 m (width) x 1.7 m (depth) x 1.25 m (height), and should be sited on a concrete slab.

Sumitomo Type:	F-70H (Europe)	F-70L (USA)	CNA-61D
Type of Compressor:	Air		Air
Dimension:	Width: 93 cm Depth: 33 cm Height: 92 cm	Width: 93 cm Depth: 33 cm Height: 92 cm	Width: 91 cm Depth: 40 cm Height: 105 cm
Weight:	142 kg	142 kg	115 kg
Voltage:	3 x 460-480 V @ 60 Hz 3 x 380/400/415 V @ 50 Hz	3 x 200 V @ 50/60 Hz	3 x 400 V @ 50 Hz
Mainly delivered to:	EU/CH	USA/CA/JP	EU/CH
Operating Current:	13 A	30 A	13 A
Minimum Circuit Ampacity:	20 A	40 A	30 A
Maximum Fuse/Circuit Breaker Size:	30 A	60 A	30 A
Compressor LRA:	13 A	30 A	74 A
Power Consumption Cool Down max. 50/60 Hz: Steady State max. 50/60 Hz:	<8.0/<9.0 kW 6.9-7.2/7.9-8.2 kW		8.0/9.2 kW 7.5/8.5 kW
Acoustic Noise:	Maximum < 75 dB(A) at 1m, outdoor unit only.		
Ambient Operating Temperature:	-30 to 45°C (-22 to 112°F)	-30 to 45°C (-22 to 112°F)	-30 to 45°C (-22 to 112°F)

Table 10.4: Technical Data for Outdoor Compressors

## 10.3 Helium Cylinders

---

The next step in the site planning for a CryoProbe accessory involves determining the location for the helium gas cylinder. A research grade helium cylinder (grade 6.0, 99.9999%) is supplied by the customer and is connected to the CryoCooling unit. The cylinder must be outside the 5 Gauss line in a serviceable location (i.e. changing the bottle should not interfere with nearby magnets). The helium regulator and a special He gas hose are supplied by Bruker.

Two lengths for the He gas hose line are available (10 m and 20 m).

The helium compressor and helium gas cylinder may be sited in a remote room or in the same room as the spectrometer as shown in the layout examples.

## 10.4 Summary of CryoProbe Options

---

### Helium Compressors (3 Options)

- Indoor Air Cooled
- Indoor Water Cooled
- Outdoor Air Cooled

### Helium Gas Transfer Lines

#### For Indoor Helium Compressors (3 Options)

- 6 m
- 10 m
- 20 m

#### For Outdoor Helium Compressors (11 Options)

- 3 m indoor line / 10 m outdoor line
- 3 m indoor line / 20 m outdoor line
- 3 m indoor line / 30 m outdoor line
- 6 m indoor line / 10 m outdoor line
- 6 m indoor line / 20 m outdoor line
- 6 m indoor line / 30 m outdoor line
- 10 m indoor line / 10 m outdoor line
- 10 m indoor line / 20 m outdoor line
- 10 m indoor line / 30 m outdoor line
- 20 m indoor line / 10 m outdoor line
- 20 m indoor line / 20 m outdoor line

### Helium Cylinder High Pressure Gas Line (2 Options)

- 10 m
- 20 m

### Helium Transfer line from CryoCooling Unit to CryoProbe

- A standard length transfer line, determined by the magnet, is delivered with each CryoPlatform. Longer transfer lines may be ordered if necessary to accommodate the CryoCooling unit in your laboratory. If a longer transfer line is required a special review of your site will be required.

### CryoPlatform

#### CryoCooling Unit

- Located outside 50 Gauss (5 mT) line.
- Must be serviceable from all sides.
- Must be at least 0.5 meters from walls on all sides.

#### Helium Compressor- Indoor Water or Air Cooled

- Located outside 5 Gauss line.
- Minimum room space is 1.25 m (width) x 0.8 m (depth) x 0.7 m (height).
- Must be serviceable from top and left side.
- The distance between the CryoCooling unit and the helium compressor component is defined by the helium transfer lines ordered.
- Chilled water lines must be supplied to helium compressor (water cooled unit only).
- Ambient operating temperature 5°–28°C.

---

#### Note:



The indoor helium compressor has rollers and is connected to flexible helium transfer lines. Water-cooled models are additionally connected to water lines supplied by the customer (typically high pressure flexible water tubing).

---

#### Helium Compressor - Outdoor Air Cooled

- Consists of one small indoor unit, one outdoor unit, and transfer lines connecting the units.
- Located outside the 5 Gauss lines (for both the indoor and outdoor unit).
- Requires indoor space of 0.5 m (width) x 1.3 m (depth) x 1 m (height).
- Requires outdoor space of 1.4 m (width) x 1.7 m (depth) x 1.25 m (height).
- The distance between the CryoCooling unit and the two helium compressor components is defined by the transfer lines ordered.
- Ambient operating temperature for outdoor components is -30–45°C.

#### Helium Cylinder

- The distance between the CryoCooling unit and the helium cylinder is defined by the length of the He gas hose ordered.
- Must be in a serviceable location (to change cylinder and not interfere with magnet).

## 10.5 CryoFit

---

This section describes the requirements for the site planning for the CryoFit.

### 10.5.1 Introduction

---

A CryoFit converts a standard CryoProbe into a flow probe within a few minutes. The CryoFit is a long metal pole with a flow cell. The flow cell is positioned inside the CryoFit during storage and installation. The outlet capillary is attached to the flow cell and runs inside the metal-pole to the top of the CryoFit. The inlet capillary is attached to the flow cell and is guide during the installation procedure through the VT-air inlet of the probe to the outside.

CryoFits are compatible with all newer 5 mm He-cooled CryoProbes as well as Prodigy CryoProbes.

The CryoFit is inserted from the top of the magnet into the upper part of the shim system (BST Upper Part) is pushed into the magnet until the end of the CryoFit sits in the spinner turbine. After this installation procedure the flow cell is pushed into the NMR probe so that is located in the area of the NMR coils like a sample tube.

### 10.5.2 Installation Requirements

---

Two essential requirements have to be observed for the CryoFit.

1. The CryoFit must be **long enough** to that it fits into the BST and the flow cell can reach the magnet center. This requirement is automatically checked during the order review.
  - If a CryoFit is ordered as accessory for an already existing, older magnet the length should be verified as the automatic conversion might not work properly.
  - The automatically selected CryoFits are will be compatible with all types of sample changers and included some security margin. In case a problem with the available ceiling height –see (2) below–, you can verify if the smaller CryoFit fits the current instrument configuration, for example if no SampleChanger is included.
2. The CryoFit requires a minimum ceiling height so that the distance between BST upper part and the ceiling allows the insertion of the CryoFit.
  - The calculation of the required ceiling height depends on many parameters (type of magnet, magnet feet, BST length, type of sample changer).

For the calculation of the magnet ceiling height (MCH) refer to the CryoFit Site Planning Guide.



# 11 Installation

All the general requirements such as power supply, compressed air supply, etc. which were discussed in the preceding chapters must first be arranged before taking delivery of the system. It must be stressed that any installation requirements listed below such as cryogen supplies, are **in addition** to those needed for normal system operation.

Where necessary the customer is advised to contact the local Port Authorities to clarify arrangements for custom clearance. If the transport crates must be opened you must first contact Bruker, as the crates are shipped utilizing Shockwatch™ and Tiltwatch™. Failure to do this may invalidate the warranty. If the transport crates are opened for any reason they must then be stored indoors (out of direct sunlight).

## 11.1 Overview

The spectrometer system will arrive at the site in crates. The crates should only be opened by the Bruker BioSpin service engineer. The commissioning of the magnet involves several stages as outlined in the table below. The installation time line given below is an approximation; each site is slightly different.

Days	Procedures
Day 1	Delivery of the magnet.
Days 2 - 5	Assembly of the magnet.
Days 6 - 12	Flushing, vacuum, leak detection, installation of the pump line.
Days 13 - 17	Precooling with liquid N <sub>2</sub> .
Days 18 - 19	Cooling with liquid He.
Days 20 - 23	Sub-cooling to reduced temperature.
Days 24 - 38	Energizing and Cryo-shimming.
Days 38 - 48	Running NMR experiments to demonstrate standard specifications.

Table 11.1: Overview of Magnet Commissioning

## 11.2 Accessibility

Before the arrival on site, the customer must ensure the equipment can be delivered, and transported safely to the final location inside the laboratory.

- Ensure that doorways, passageways and lifts have sufficient clearance.
- Extra large doorways are required for the larger magnets.
- Equipment such as forklifts or hydraulic pallet jacks are necessary for transporting the magnet and accessories.

## 11.3 Installation Requirements Checklist

For the installation the customer must provide the following:

Lifting equipment and minimum ceiling height as outlined in the table in <a href="#">Charging the Magnet [ 77]</a> . Pallet jack and/or fork lift for transporting system accessories.	—
Two cylinders of N <sub>2</sub> gas 50l/200 bar (~2 cu.ft, 3000 psi, 4.6 grade) with reducing regulator valves to deliver pressure of 0.5 bar (~8 psi), as specified in <a href="#">Other Specifications [ 44]</a> .	—
Six cylinders of He gas 50l/200 bar (~2 cu.ft, 3000 psi, 4.6 grade) with reducing regulator valves to deliver a pressure of 0.2 bar (~3 psi), as specified in the section <a href="#">Other Specifications [ 44]</a> .	—
Quantities of liquid helium and nitrogen as specified in the table in <a href="#">Charging the Magnet [ 77]</a> .	—
Liquid helium and nitrogen transport dewars as specified in <a href="#">Compressed Gas [ 43]</a> .	—
One power outlet 230V/16A (USA 208V/30A) single phase and two more 230V/16A (USA 208V/20A) single phase power outlets are needed to run a vacuum pump, a heat gun, and a power supply unit. These power outlets must be available in addition to the main power source used to run the spectrometer.	—
Step ladder (non-magnetic e.g. aluminum, fiberglass, or wood).	—
Where possible the customer should provide the following: <ul style="list-style-type: none"> <li>• Heat gun or hand held hair dryer (min. 1200 W).</li> <li>• Cryogenic gloves.</li> <li>• Electric screwdriver.</li> </ul>	—

Table 11.2: Installation Requirements Checklist

## 11.4 Installation Procedure

The various steps and procedures mentioned in the [Overview \[ 75\]](#) will be discussed in detail in the following sections.

### 11.4.1 Magnet Assembly

When the magnet is delivered (do not uncrate it!) it must first be assembled by the installation engineer. The assembly area must be clean, dry and free of dust.

The assembly may require that the engineer works beneath the magnet and thus special rigging equipment is required. Refer to the section [Magnet Access and Rigging \[ 23\]](#) for special equipment requirements for assembly.

### 11.4.2 Magnet Evacuation and Flushing with Nitrogen Gas

Once the magnet has been assembled and placed in the magnet room, rough pumping of the cryostat can begin. At the same time the cryostat is flushed through with dry nitrogen gas. The customer must provide a 50l (4.6 grade)/200 bar (~2 cu.ft, 3000 psi) cylinder of dry nitrogen gas (99.996% purity). The cylinder should be fitted with a secondary regulator valve to deliver a pressure of 0.5 bar (~8 psi).

Further pumping of the cryostat is carried out by a turbo pump to reduce the internal pressure.

### 11.4.3 Cooling the Magnet to Liquid Nitrogen Temperature

This next stage involves filling the magnet with liquid nitrogen. The quantity of liquid nitrogen required is listed in the table in the [Charging the Magnet \[ 77\]](#). The transfer dewars used for precool generally have a capacity of 250 - 500 liters (attention: maximum pressure < 0.5 bar) with a fixture for pressuring and transferring via a stainless steel or corrugated plastic tube of 10 mm (~3/8") diameter.

### 11.4.4 Cooling the Magnet to Liquid Helium Temperatures

For this procedure, the customer must provide the following:

- Six cylinders of helium gas: 50l (4.6 grade)/200 bar (~2 cu.ft, 3000 psi), 99.996%, with secondary regulator value to deliver pressure of max 0.2 bar (~3 psi).
- Quantities of liquid helium as specified in the table found in [Charging the Magnet \[ 77\]](#).
- Liquid helium dewar: 250 - 500 liter capacity, with NW25 flange or suitable outlet compatible with the 12.7 mm (1/2").

When ordering the helium the customer should arrange to have it delivered immediately before cooling the magnet to liquid helium temperature. If delivered to the site much earlier, losses due to evaporation will occur and must be taken into account (usually 1% of nominal volume/day).

### 11.4.5 Charging the Magnet

The final stage involves bringing the magnet to field. This will take 1-3 days depending on the magnet type. During charging there is a possibility for the magnet to experience a quench.

The quantities of liquid helium for final cool down and energization/cryoshimming as well as extra liquid helium required after one quench are specified in the table below. The customer is required to provide the cryogens needed for the complete installation including up to two training quenches.

The values of liquid nitrogen and helium in the table below are the minimum requirements. An extra 20-30% of each is advisable, particularly as many suppliers will take back unused cryogens.

Magnet Type	Min. Ceiling Height (m)	Min. Hook Height* (m)	Total Lifting Weight** (kg)	LN2 Needed for Precool (l)	LHe Needed for Cool-down and Charging (l)	LHe After a Training Quench (l)
Ascend 850	3.60	3.10	4,100	~2,500	~2,500	~750

\* Hook height needed when using the standard lifting harness from Bruker as shown in [Figure 5.1 \[ 27\]](#). A reduced hook height is possible using alternate lifting accessories.

\*\* Total weight including transit restraints and crate.

Table 11.3: Installation Requirements



# 12 Contact

**Manufacturer:**

Bruker BioSpin AG  
Industriestrasse 26  
CH-8117 Fällanden  
Switzerland  
Phone: +41 44 825 9111  
<http://www.bruker.com>

**NMR Hotlines**

Contact our NMR service centers.

Bruker BioSpin NMR provides dedicated hotlines and service centers, so that our specialists can respond as quickly as possible to all your service requests, applications questions, software or technical needs.

Please select the NMR service center or hotline you wish to contact from our list available at:

<https://www.bruker.com/service/information-communication/helpdesk.html>



# List of Figures

Figure 2.1:	Stronger Stray Fields in Vertical Direction than in Horizontal Direction.....	10
Figure 3.1:	Spectrometer and Magnet Control.....	20
Figure 3.2:	CryoProbe System.....	21
Figure 3.3:	Other Options for AVANCE Systems.....	22
Figure 4.1:	Unloading the Magnet Crate and Placing on Air Skates.....	26
Figure 5.1:	Area of Maximum Ceiling Height Needs to be Extended to Allow for the Lift System's I-beam.....	27
Figure 5.2:	Helium Transfer Line Insertion.....	28
Figure 6.1:	Magnetic Stray Field Plot Ascend 850/54.....	30
Figure 7.1:	Floor Velocity vs. Frequency Plots for Generic Vibration Criterion (VC) and for the Bruker Magnet with API.....	33
Figure 7.2:	Example of an Average Spectrum Measurement with 0.125 Hz Resolution, 1-200 Hz Frequency Range and 60 Minutes Recording Time.....	34
Figure 7.3:	Specification Framework with the Magnetic Field Represented as 0 to Peak Values..	38
Figure 8.1:	Main Electrical Power Requirements Flowchart.....	42
Figure 8.2:	Example of a Typical Dryer/Filter System Setup.....	45
Figure 9.1:	Top View of the Ascend 850 Magnet.....	55
Figure 9.2:	Ascend 850 NMR Layout Example.....	62
Figure 10.1:	CryoProbe System Overview.....	64
Figure 10.2:	Admissible Ranges for the Temperature and Flow of the Cooling Water.....	66
Figure 10.3:	Cooling Water Typical Flow Characteristics.....	66
Figure 10.4:	Helium Compressor - Indoor Water Cooled.....	67
Figure 10.5:	Helium Compressor - Indoor Air Cooled.....	68
Figure 10.6:	Helium Compressor - Outdoor Air Cooled.....	68



# List of Tables

Table 1.1:	Metric to American Conversion Factors.....	7
Table 2.1:	BGV B11 Standards for Standard Precautions and Users .....	13
Table 2.2:	BGV B11 Standards Under Special Conditions for Selected Subgroups .....	13
Table 2.3:	Example of Maximum Retention Periods.....	13
Table 4.1:	Door Dimensions for Magnet Access .....	24
Table 4.2:	Door Dimensions for Magnet Room Access: Spectrometers .....	25
Table 4.3:	Crate Dimensions and Weights for Accessories.....	25
Table 5.1:	Minimum Ceiling Height Requirements Inside the Magnet Room .....	28
Table 6.1:	Magnetic Stray Fields for the 850/54 Ascend Magnet .....	29
Table 7.1:	Application and Interpretation of the Generic Vibration Criterion (VC) Curves.....	32
Table 7.2:	Maximum Floor Velocity Thresholds for the Bruker Magnet with API.....	33
Table 7.3:	Recommendations for Static Magnetic Objects.....	34
Table 7.4:	Guidelines for Moveable Magnetic Objects .....	35
Table 7.5:	List of Most Commonly Studied Nuclei and Corresponding Resonance Frequencies .....	39
Table 8.1:	Pressure and Flow Requirements .....	44
Table 8.2:	VT Nitrogen Gas Quality (500 MHz and above) .....	44
Table 8.3:	Maximum Humidity in the NMR Laboratory .....	50
Table 8.4:	Heat Dissipation into the Room by Typical AVANCE Systems .....	50
Table 8.5:	Helium Gas After a Quench.....	51
Table 9.1:	Dimensions and Weights of NMR Equipment.....	56
Table 9.2:	Dimensions and Weights of Magnet .....	56
Table 9.3:	Recommended Magnet Slab Dimensions .....	57
Table 9.4:	Maximum Field Strength for NMR Equipment .....	59
Table 9.5:	Utility Requirements.....	61
Table 10.1:	CryoCooling Unit Specifications .....	65
Table 10.2:	Cooling Water Specifications.....	67
Table 10.3:	Technical Data for Indoor Compressors .....	69
Table 10.4:	Technical Data for Outdoor Compressors .....	70
Table 11.1:	Overview of Magnet Commissioning .....	75
Table 11.2:	Installation Requirements Checklist.....	76
Table 11.3:	Installation Requirements .....	77



# Index

## A

Air compressor .....	20
Air conditioning .....	35
Airplanes .....	31
Air-skates .....	26
Automobiles.....	31
AVANCE Cabinet	
Dimensions and weight .....	56

## B

B-CU-I	
Dimensions and weight .....	56
BCU-I cooling unit .....	43, 44
BCU-I Unit .....	20
BCU-II	
Dimensions and weight .....	56
BCU-II cooling unit .....	44
BCU-II Unit .....	20
BMPC	
Dimensions and weight .....	56
BMPC II .....	20
Breathing equipment .....	17
Buffer containers .....	45

## C

Compressors .....	31
Constant flow rate .....	46
Construction sites.....	31
Crates.....	24
CryoCooling unit.....	43
Cryogen	
Transport dewars .....	16
Cryogenic liquids .....	15
Storage containers .....	15
Cryogens	
Boil-off of liquids .....	14
Cryogenic gas to liquid volume ratios.....	14
High pressure gas-packs.....	16
Safe handling of cryogenic liquids.....	15

## D

D.C. operated elevators, trains.....	35
DC EMF.....	36
Dewars .....	60

## E

EAPD.....	51
Earthquakes .....	17

Electric motors.....	35
Electrical outlets .....	60
Electrical power requirements .....	41
Electrostatic Discharge.....	57
Elevators .....	16, 35
Emergency access .....	17
Emergency Plan .....	17
Emergency Sample Protection Device.....	43
ESD resistant flooring.....	57
External Disturbance Suppression .....	38

## F

Fans .....	31
Faraday cage .....	39
Ferromagnetic materials.....	34
Ferromagnetic objects .....	10
Fiberglass.....	57
Fire extinguishers .....	17, 53
Floor Types	
PVC.....	57
Vinyl.....	57
Wood.....	57
Fluxgate magnetometer .....	36

## G

Gas cylinder .....	16
Gas cylinder storage .....	60
Generators .....	31

## H

Heat detectors .....	53
Heat source .....	55
Helium gas cylinder .....	21
Helium gas supply	
CryoCooling Unit .....	65
HF environments .....	39
HF transmitters.....	35
Homogeneity .....	34
Humidity .....	20
HVAC system .....	50
Hydraulic Lifting System .....	26

## I

Isolated slab .....	57
---------------------	----

## J

Joule-Thompson Cooling Unit .....	19
-----------------------------------	----

## L

Leveling Sheets.....	26
Lifting hook .....	27
Liquid helium refill.....	16

Lock hold .....	37
Loose ferromagnetic objects .....	10

## M

Machinery .....	31
Magnet maintenance .....	19
Magnet pits .....	58
Magnet temperature .....	19
Magnetic field .....	9
Exclusion zone .....	10
Magnetic field strength .....	12
Magnetic flux density .....	12
maximum point load .....	56
Medical implants .....	10

## N

Nitrogen	
Safe handling during refills .....	16
nitrogen separator .....	43

## O

Oil Content: .....	44
Optical smoke detectors .....	53
overall floor load .....	56
Oxygen level sensors .....	51
Oxygen-cylinders .....	17

## P

Pacemakers .....	10
Power consumption	
CryoCooling Unit .....	65
Power lines .....	35
Power transformers .....	35
pre-action sprinkler system .....	53
Pressure relief valve .....	16
Pump line .....	19

## Q

Quench .....	15
--------------	----

## R

Radio's .....	39
Refilling	
Safe handling of liquid nitrogen .....	16
Rigging equipment .....	26
Lifting hook .....	27

## S

Safety	
Exclusion zone .....	10

Ferromagnetic objects .....	10
Magnetic field .....	9
Medically active implants .....	10
Safe handling of cryogenic liquids .....	15
Safe handling of liquid nitrogen .....	16
Ventilation .....	14
SampleCase .....	22
SampleJet .....	22
SampleXpress .....	22
Satellite systems .....	39
Satellites .....	35
Service access	
Magnet .....	60
Spectrometer .....	60
Solid Impurities .....	44
Stainless steel .....	57
Standard Operating Procedures .....	17
Subways .....	35
Sunlight .....	55
Support beams .....	55

## T

Television broadcasts .....	39
Television stations .....	35
temperature sensors .....	53
Trains .....	31
Trams .....	35
Transformers .....	35

## U

UltraStabilized Magnets .....	19
-------------------------------	----

## V

Ventilation	
Emergency ventilation .....	14
HVAC systems .....	14
When using a magnet pit .....	58
Vibrations .....	31
Slabs .....	57
VT gas .....	20
VT Nitrogen Gas Quality .....	44
VT work .....	43

## W

Water Content: .....	44
Workstation	
Dimensions and weight .....	56





**Bruker Corporation**

[info@bruker.com](mailto:info@bruker.com)  
[www.bruker.com](http://www.bruker.com)

Order No: H157657