

Modular Compact Rheometer

MCR Series

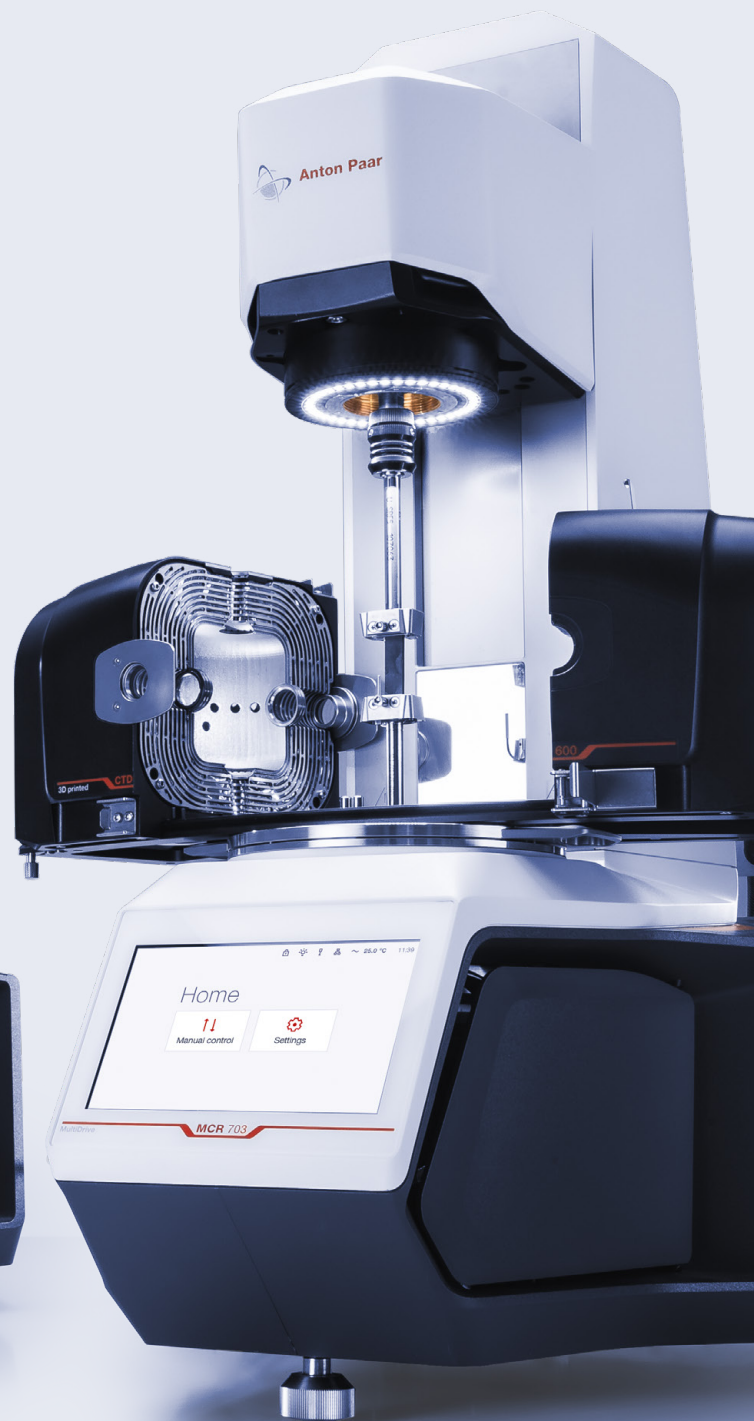

A New Era in Rheometry

The new-generation MCR Series is a groundbreaking rheometer based on new modular platform architecture. The instrument delivers outstanding measurement quality to guarantee excellent reproducibility and remarkable productivity. Choose from the biggest portfolio on the market. We have an instrument for every need.

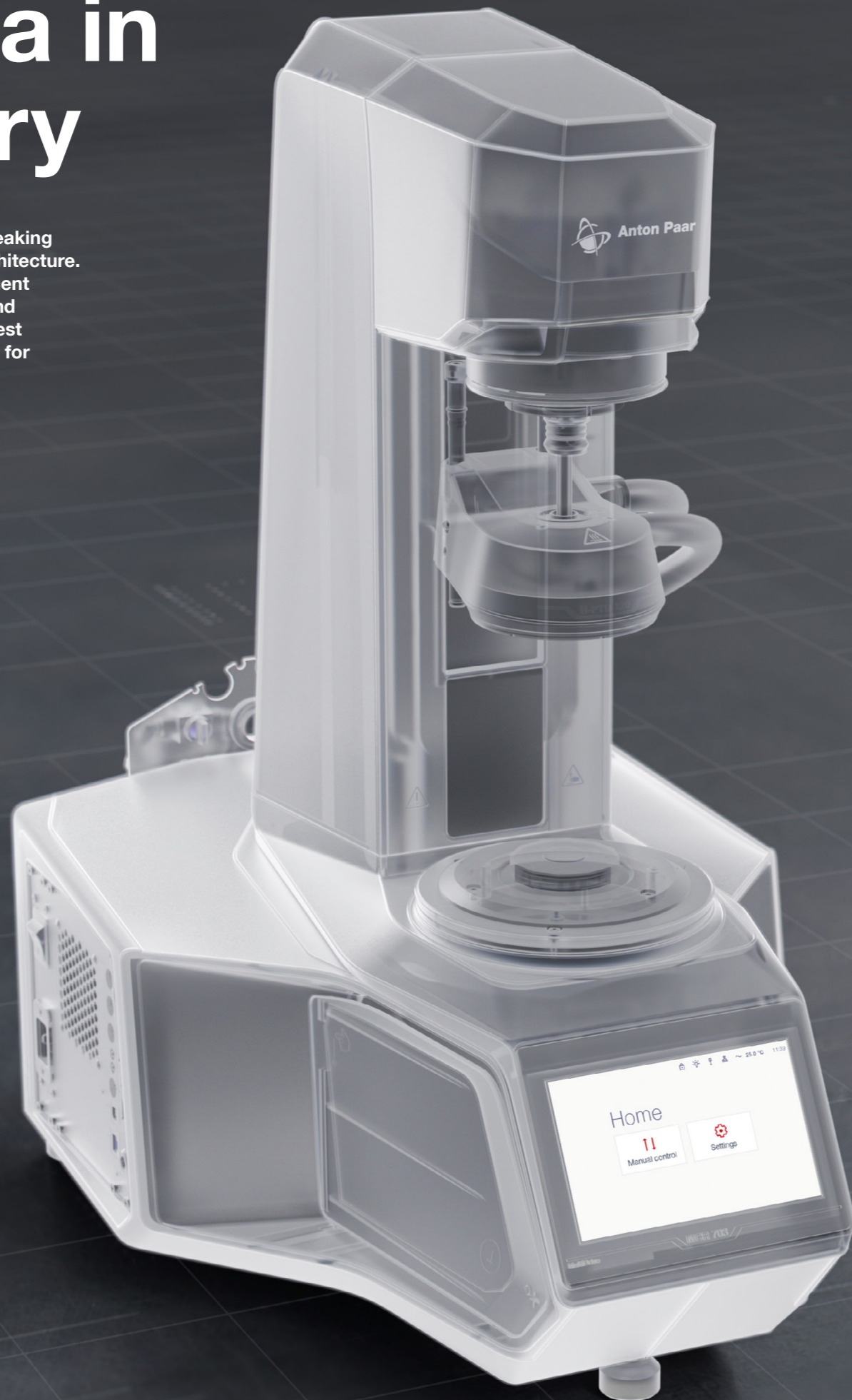

Torque range
from 0.2 nNm
to 300 mNm

Maximum
frequency of
rotational drive
up to 200 Hz

Temperature
control from
-170 °C to
+1,000 °C

250+ pre-defined
test templates

15 devices and
200+ accessories

Ready for DMA,
tribology, powder
rheology, and
mechanical testing

35+ subsidiaries
for fast support,
wherever you are

16,000+
installations
worldwide

20+ years of
technology
leadership



Find out more

The Most Precise Rheometer

Step into a new era of rheometry with the most precise rheometer to date, offering improved measurement quality and insights unattainable by users of other instruments. This rheometer gives you new, previously unthinkable applications and makes every measurement better.

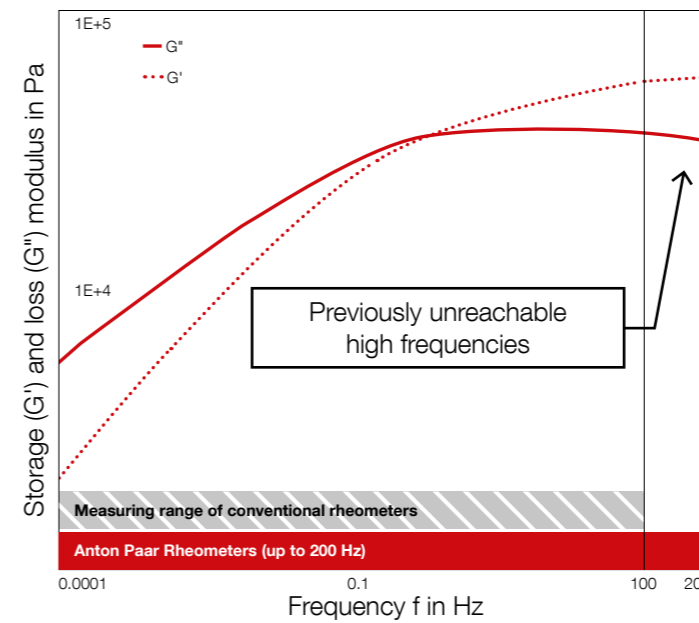

Frequency: Up to 200 Hz

Extend your frequency range to 200 Hz and access more information than ever before within a reduced measuring time.

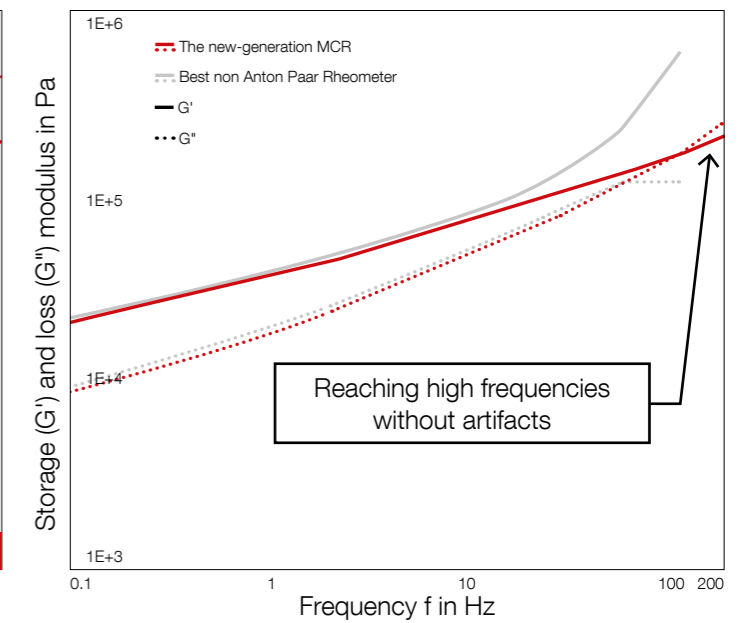

Forget about inertia at high frequencies

Outstanding controllers – plus SMT mode with two EC motors – enable highest-frequency measurements, where others fail due to inertia. The crossover point of the pressure-sensitive adhesive measured above can only be captured with an MCR 703. No other rheometer in the world can achieve this.

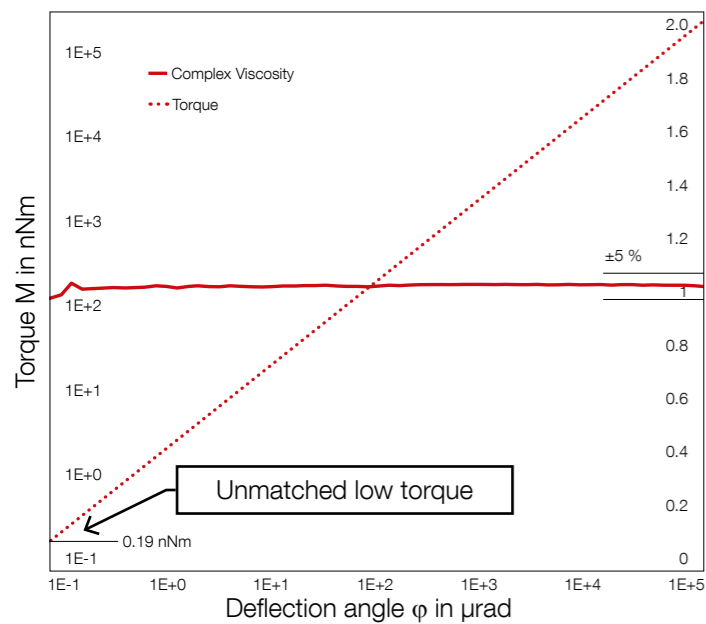

Unmatched torque performance

The reimagined EC motor offers unique low torque sensitivity for precise measurements. Minimum torque of just 0.2 nNm in oscillation ensures exceptionally accurate results.

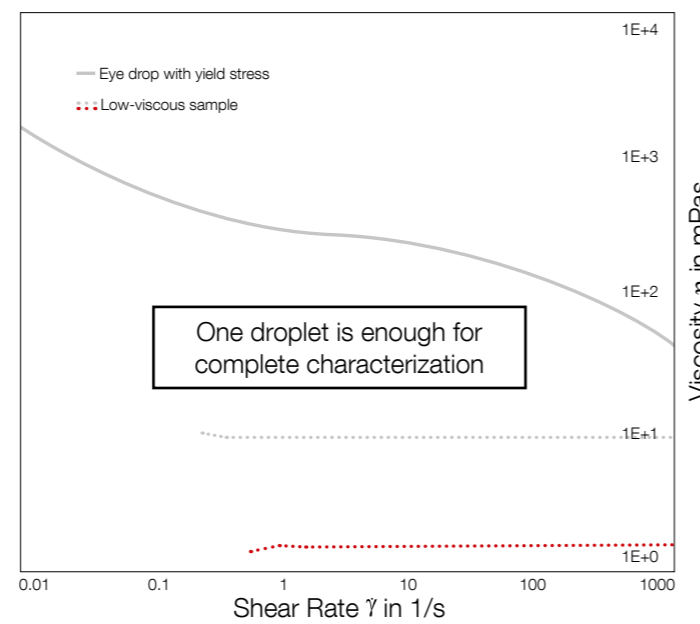

Measure more precisely with less sample

Whether it's a precious low-viscosity protein or a single eye drop – just 70 μl is enough for complete characterization. Reduce sample volume without compromising measurement range, even at low viscosities.

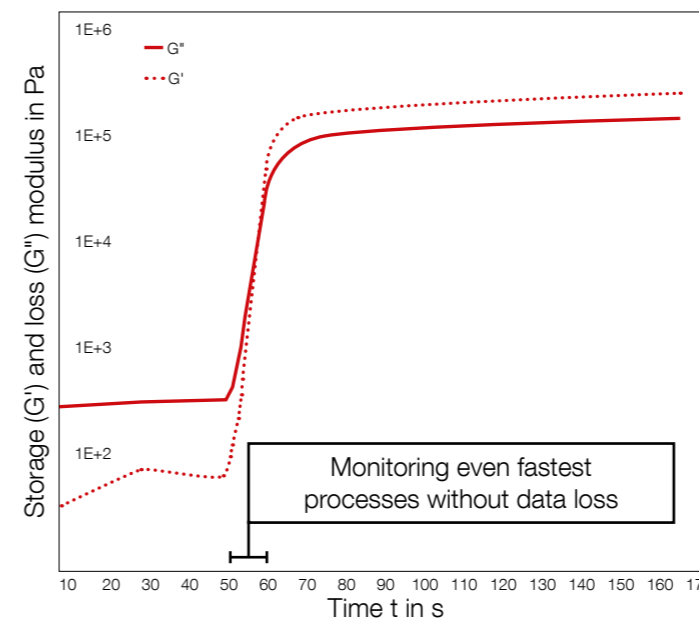

New electronics for the fastest data acquisition

Monitor even the fastest curing processes without any data loss. Next-generation electronics and intelligent controllers (e.g., high dynamic gap control) result in the fastest data acquisition.

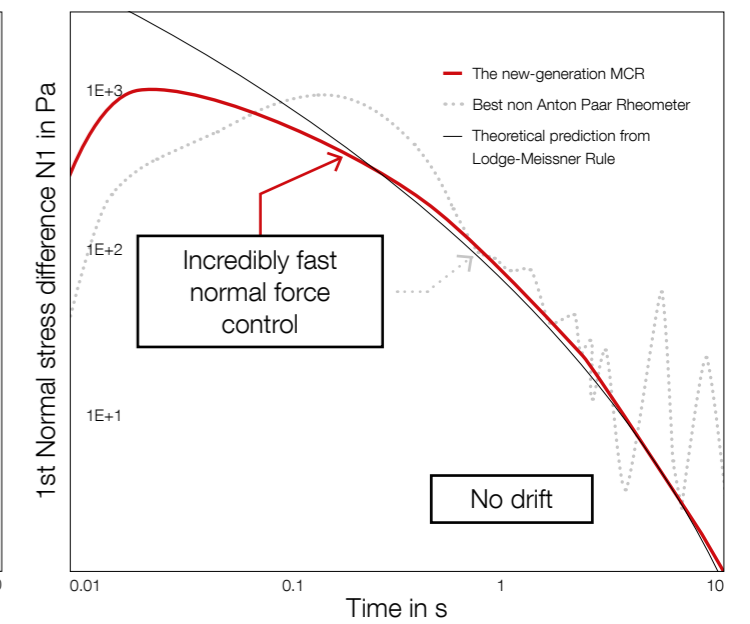

New normal-force sensor

Avoid delayed transient normal force data, resulting in unmatched quality of normal stress difference measurements.

The Smartest and Fastest Rheometer, from Start to Finish

⊕ **Sustainability:** Save energy costs, and reduce your carbon footprint. In combination with the cost-efficient air Peltier temperature devices, the MCR saves up to 56 % more energy.

⊕ **Lab space:** All-in-one design preserves precious bench space.

⊕ **Quick boot time:** The MCR starts in just six seconds, over 7x faster than other devices.

Pre-Measurement



Electronic level

Eliminate inexplicable measurement errors due to lack of levelling. Quickly and straightforwardly, the electronic level of the MCR is saved in the measurement dataset, so you can fully trust your results.

QuickConnect coupling

Couple your measuring geometry within seconds with just one hand.

Toolmaster

Fully automatic recognition of measuring systems and accessories minimizes errors.

Touchscreen operation

The integrated touchscreen has all the functions necessary to prepare a test directly from the rheometer.

Temperature calibration

Our temperature calibration sets automatically calibrate the temperatures. They cover a range as wide as -160 °C up to +600 °C. The calibration data is saved, ensuring accurate results for all subsequent measurements.

Trimming mirror and TruRay

The trimming mirror and TruRay illumination provide clear 360-degree visibility for sample trimming, optimizing measurement results and sample loading.

Measurement

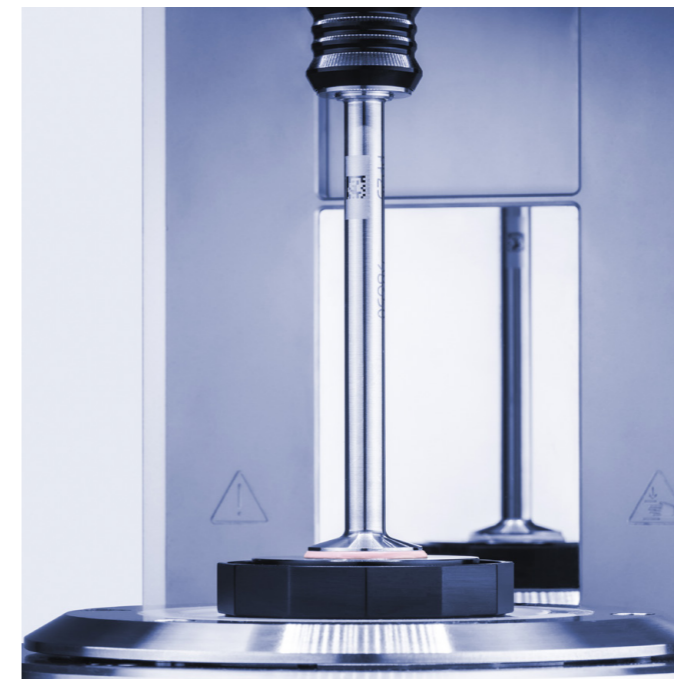

Temperature equilibrium

There's no need to waste time ensuring temperature equilibrium. The MCR's automatic temperature equilibrium recognition gets you to accurate results quickly.

Sample-adaptive controller

The sample-adaptive controller delivers high-quality results for unknown samples without time-consuming controller presetting.

Automatic gap control

Temperature-related gap dimension change is compensated by using the automatic gap control (AGC) function to guarantee correct gap settings.

Post-Measurement

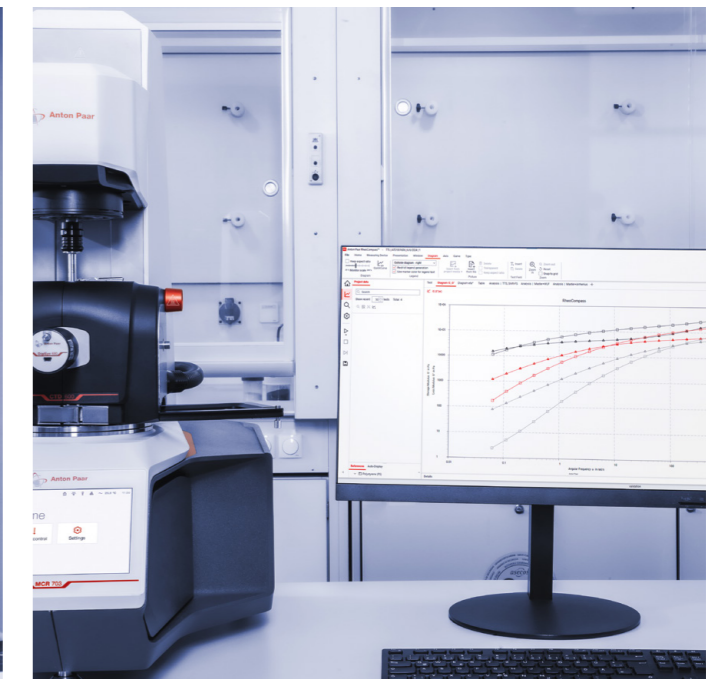

RheoCompass software

The powerful RheoCompass software provides templates with ready-to-use reports as well as a report-customizing designer.

RheoCompass includes additional, improved analysis tools far beyond those of other rheometer software – resulting in deeper insights into your materials.

New analysis tools are frequently added to the software ensuring that you're always up-to-date.

The Choice Is Yours

Broadest portfolio on the market: ViscoQC series and RheolabQC: Complete viscometer portfolio for entry-level applications | MCR 72 and MCR 92: Quick, straightforward rheological measurements | SmartPave rheometer: Designed for the asphalt industry | SmartMelt rheometer: Designed for polymer melt rheometry | MCR 503 Power: The most powerful rheometer model for special applications (with maximum torque of 300 mNm and normal force of 70 N) | FRS (furnace rheometer): Sample temperatures up to 1,730 °C | HTR automated rheometer: Operated by a robotic arm



MCR 303

Quick configuration

- Entry ticket into rheological product development and material formulation
- Torque range from 5 / 1¹⁾ nNm to 215 mNm
- Broad range of temperature-based accessories
- Productivity features such as Toolmaster, QuickConnect coupling, TruRay, and many more
- Replacement for the successful MCR 102e

MCR 503

Top-selling rheometer with entry-level DMA

- The top-selling rheometer for R&D and high-end QC testing
- Torque range from 0.2 nNm to 230 mNm
- Sample adaptive controller (TruStrain) included and DMA-ready
- 200+ plug-and-play accessories
- Solution for rheology, tribology, powder, entry-level DMA and mechanical testing
- Replacement for the top-seller MCR 302e

MCR 703 MultiDrive

A market-leading rheometer and DMA in one instrument

- Torque range from 0.2 nNm to 230 mNm empowering users to tackle the scientific challenges of tomorrow
- Upgrade with a second EC motor: Sophisticated working modes for in-depth rheometry – CMT, SMT, counter-movement (high shear), and superpositions
- Upgrade with a second linear drive: The most advanced dynamic mechanical analysis in all modes
- Advanced rheo-optical analysis

MCR 703 Space MultiDrive

Unique modularity, flexibility, and functionality

- Open instrument design for maximized working space and optimal access
- Torque range from 0.2 nNm to 230 mNm
- Expansion of MCR 703 MultiDrive functionalities
- Easy installation of 200+ accessories for research and development
- Straightforward combination with additional optical or mechanical setups, (e.g., a confocal microscope)
- Perfect choice for glovebox work, even in inert gas atmosphere (e.g., nitrogen, argon)

1) 1 nNm with activated TruStrain™ option

MCR 703 MultiDrive: The Most Advanced Rheometer



Find out more

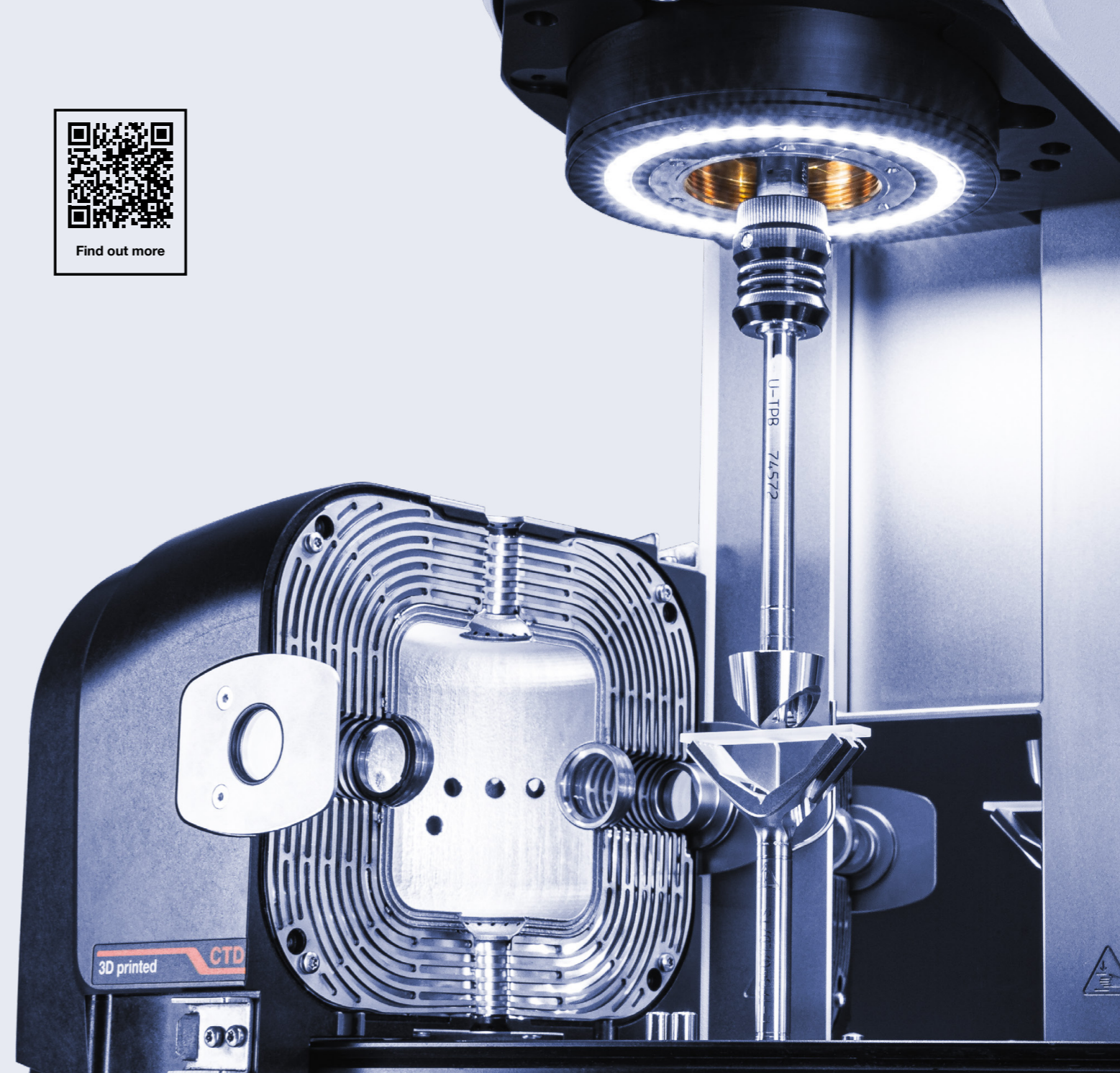

The flagship MCR 703 MultiDrive is the most advanced platform for rheology and DMA. Designed for high-end R&D, the instrument is the reference for sophisticated material characterization.

One rheometer, all rheological working modes

- Unique setup: Work with one EC motor in combined motor transducer (CMT) mode, or two EC motors in separate motor transducer (SMT) mode
- SMT mode: One motor is operated solely as a torque transducer, while the other is used as a drive unit only – delivering the purest rheological results
- CMT mode: Use the motor's real-time position control (TruStrain), or perform "classic" stress-controlled tests in combination with the extensive range of accessories

Expanding the limits of material characterization with counter-movement mode

- Two EC motors can rotate or oscillate in opposite directions
- Generation of fixed stagnation plane – helpful for advanced structure analysis of a sample with a microscope
- Extensional tests to previously unachieved elongation levels when combined with the universal extensional fixture
- Doubling of the maximum achievable rotational speed of the rheometer up to 6,000 rpm – helping broaden the shear rate range for high-shear applications

A revolutionary step for DMA

- Modular MCR concept allows easy integration of an additional lower linear drive for DMA in tension, bending, compression, creep and creep recovery tests, relaxation tests, and thermomechanical analysis
- Combined with the upper rotational drive for DMA in torsion, the setup enables complete characterization of viscoelastic solids with axial-torsional DMA – including determination of the Poisson's ratio and the direction-dependent characterization of anisotropic materials

Previously unthinkable applications

- The maximized workspace of MCR 703 Space MultiDrive allows easy installation of accessories and combination with additional external setups (e.g., a confocal microscope) suitable for advanced material characterization
- The rheometer's separate electronics box lets you set up the rheometer in a laboratory or in a laboratory glovebox, even when using inert gas atmosphere (e.g., for high-temperature measurements on samples with a certain hazard level)

Patents: US Pat. 8453496 and US Pat. 9766172

Patents: US Pat. 9574983 and US Pat. 10908058

RheoCompass

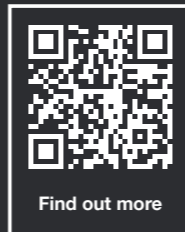

The most powerful rheometer operating software for years.

RheoCompass is now accessible for everyone, with a new user interface and touchscreen for quick instrument operation. Be ready for any challenge, from routine QC testing to scientific applications.



Accessible for everyone in everyday applications

Quality control technician: App manager with 250+ predefined templates | Touch control | Plausibility check of measurement parameters | Extended Toolmaster for automatic recognition and configuration | Automatic storage of measurements | Available in eight languages

Lab managers: Customizable measurement templates | Countless analysis methods for routine and advanced data analysis | Central database handling | Complete pharma package: Audit trail, electronic signature, and retrieval | Full compliance with QM regulations | Automatic data exchange with a LIMS

Researchers: Special packages and analyses for time-temperature superposition, calculation of molar mass distribution and relaxation-time spectrum, interfacial rheology, tribology, powder rheology, and SALS | Definition of even the most complex test methods | Camera control | Leveraging of raw data to record Lissajous figures, waveforms, and LAOS data



We Have What You Need

Explore our portfolio of 7,000+ measuring geometries and 200+ accessories. We also provide customized solutions.

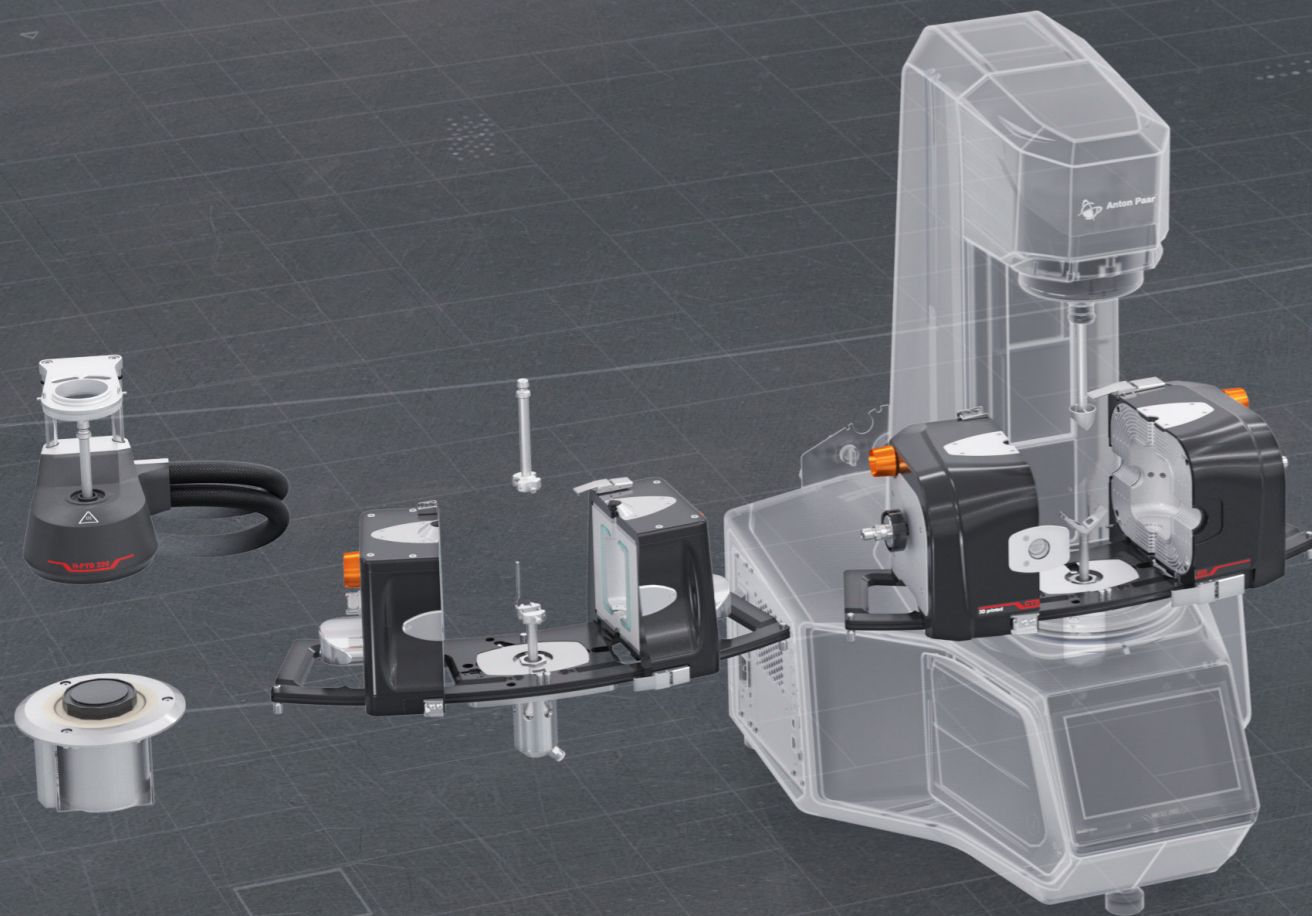

Measuring geometries

7,000+ options for countless variations in materials, surfaces, and geometric properties. Disposable systems, covers, solvent traps, and adapters for light guides or probes are also available.

Temperature devices

40+ options for the broadest temperature range (-170 °C to +1,000 °C) and greatest precision with zero gradient.

Additional parameter settings

Broadest portfolio for applying pressure, humidity, voltage, and magnetic fields.

RheoOptics and structure analysis

Microscopy, Raman and IR spectroscopy, dielectric spectroscopy and impedance, polarized light imaging, small-angle X-ray and light scattering options available.

Extended material characterization

Analysis of starch, interface and surface layers, large particles, extensional properties, and bitumen.

The Broadest Temperature Range

Additional temperature options: Low-temperature options: Evaporation unit for cooling with liquid nitrogen down to **-170 °C** | Gas chiller options for cooling down to **-90 °C** without liquid nitrogen | Immersion: Cups to characterize samples while immersed in a temperature-controlled fluid | For extensional fixtures, plate-plate geometries, and DMA fixtures



Peltier temperature device



Electrical temperature device

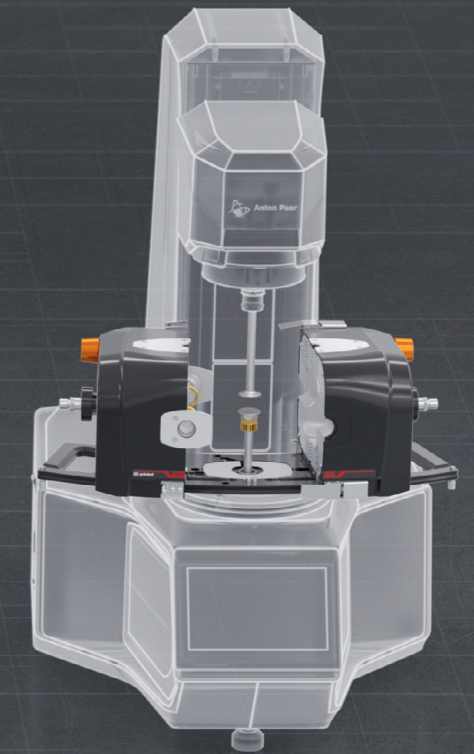

Convection temperature device

-170 °C

+1,000 °C

40+ temperature devices control the greatest rheological influence of all. We offer the biggest range on the market, so you can measure at every temperature and with every application.

Peltier temperature device

Compact and easily installable temperature devices based on heating and cooling using Peltier elements up to 220 °C:

- Unique temperature range from **-50 °C to +220 °C**
- Temperature devices combinable with plate-plate, cone-plate, concentric-cylinder, double-gap measuring geometries, and stirrers
- Active cooling without the need for additional low-temperature options
- Air-cooled Peltier systems available (no fluid circulator needed)

Electrical temperature device

Fast temperature devices based on electrical heating and cooling with pressurized air or fluid for temperature control:

- Temperature range from **-150 °C to +400 °C**
- Temperature devices combinable with plate-plate, cone-plate, concentric-cylinder, double-gap measuring geometries, and stirrers
- Additional heated hoods for minimized temperature gradients

Convection temperature device

The most flexible temperature devices based on forced convection of air or gas and radiation:

- Unique temperature range from **-170 °C to +1,000 °C**
- Temperature devices combinable with all measuring systems
- Gradient-free temperature control
- Integrated light and camera allowing real-time visualization of a sample
- Unique Peltier-based convection temperature device available to enable active cooling without the need for low-temperature accessories

Additional Parameter Settings

Perform temperature-controlled rheological tests while applying an additional external parameter. Check how an additional parameter influences the behavior of your sample.



Pressure cells

- Broadest portfolio on the market for applications in food, polymers, and petrochemicals
- Temperature range: -30 °C to +300 °C
- Pressure dependence of viscosity, simulation of extrusion and cooking conditions, avoidance of sample evaporation, influence of gases on viscosity (e.g., supercritical CO₂)
- Up to 1,000 bar
- Gas-, liquid-, or self-pressurization can be used to control the pressure

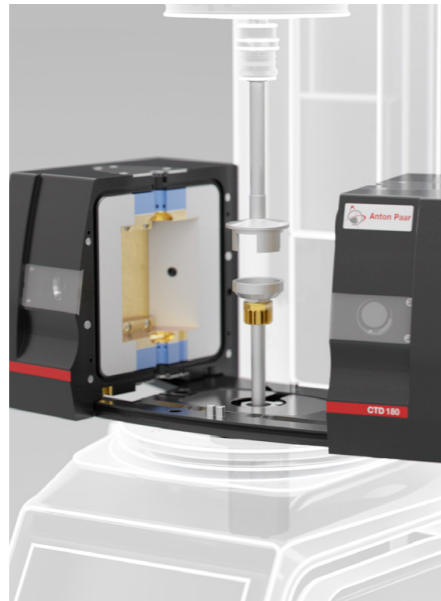

Humidity option

- Environmental system to control humidity and temperature – allowing the study of the influence of environmental conditions as well as drying kinetics
- Temperature range: 5 °C to 120 °C
- Humidity range: 5 % to 95 %
- Unique combinations with powder, tribology, DMA, extensional, and UV
- Standard- and custom-designed measuring systems can be used
- Patents: AT Pat. 513661 and DE Pat. 102015100714



UV curing systems

- Study of kinetics during UV curing
- Temperature range: -40 °C to +300 °C
- Different mercury and LED light sources available, wavelength adoptable
- Usable with Peltier, electrical, and convection temperature devices
- Unique combinations with Raman or IR spectroscopy to simultaneously determine changes in the molecular level, and humidity option to control humidity

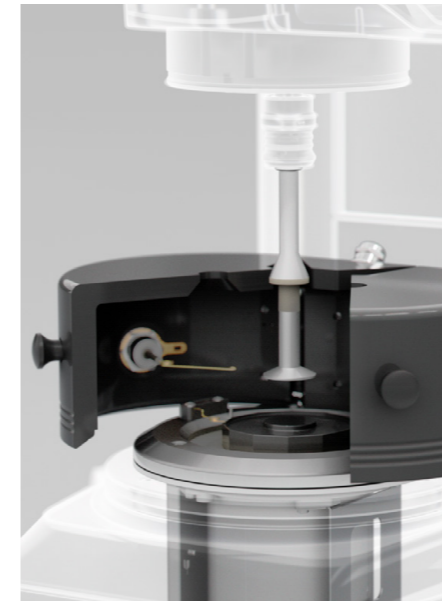

Electro-rheological device (ERD)

- Characterization of electro-rheological fluids
- Temperature range: -40 °C to +200 °C
- Voltage range: 0 kV to 12.5 kV DC (AC on request)
- For plate-plate and concentric cylinder geometries
- Suitable for rotational, oscillatory, and squeeze flow



Magneto-rheological device (MRD)

- Characterization of magneto-rheological fluids
- Temperature range: -40 °C to +170 °C
- Flux density: Max. 1.4 Tesla
- Patented TwinGap geometry (US Pat. 8132445) enables the highest homogeneous magnetic fields and higher shear rate measurements



Immobilization cell (IMC)

- Investigation of immobilization kinetics, water retention, and drying by simulating process conditions
- Vacuum generated by a pump forces the liquid phase of the sample to penetrate into the base paper so the moisture is extracted from the coating

Applications

Crude oil
Food
Petrochemicals
Polymers

Adhesives
Coatings and paints
Food
Pharmaceuticals
Polymers
Sealants

Adhesives
Coatings
Dental composites
Epoxy resins
Glues
Printing inks

Applications

Clutches and brakes
Dampers
Food
Haptic devices
Printing inks
Pumps
Shock absorbers

Brakes
Clutches
Human prosthesis
Sealings
Seismic dampers
Shock absorbers

Paints
Paper coatings
Slurries

RheoOptics and Structure Analysis

The combination of rheometry and structural analysis provides both the macroscopic big picture and simultaneous insight into the smallest microstructural changes.

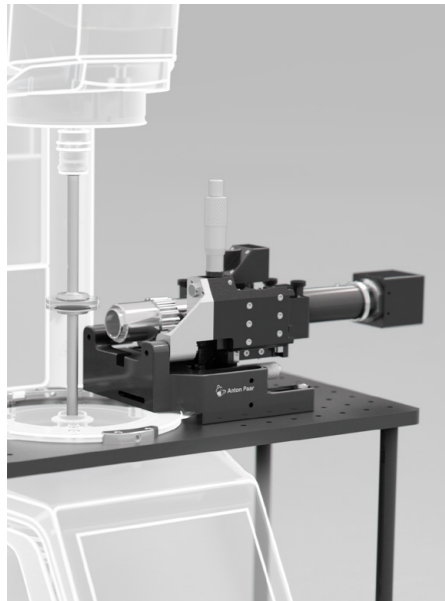

Rheo-microscopy

- Insight into the structure of the sample during shearing
- Temperature range: -20 °C to +300 °C
- Variants for configurations with one EC and two EC motors (view at stagnation plane) available
- Modules for polarizers and fluorescence
- Direct assignment of images and videos to rheological data

Rheo-Raman and IR spectroscopy

- Combination of two powerful measurement principles: Rheology for mechanical properties and Raman or infrared spectroscopy for molecular analysis
- Temperature range: -20 °C to +300 °C
- Unique combination with UV curing possible
- Can be combined with Anton Paar's Cora and other spectrometers
- Usable near-IR (NIR) and mid-IR (MIR) as well as attenuated total reflection mode (ATR)

Dielectric spectroscopy and impedance

- Dielectric spectrum providing information on the internal structure
- Temperature range: -160 °C to +600 °C
- Electrolyte contact-free, or spring, wire-shaft contact
- Various LCR meters can be combined
- Permittivity and impedance analysis

Polarized light imaging

- Visualization of shear stress
- Temperature range: -20 °C to +300 °C
- Parallel-plate and cone-plate measuring geometries
- Illuminated sample diameter: 25 mm
- Movable polarizer for selecting parallel or orthogonal polarization
- Customized setup based on high speed polarization camera for high resolution shear stress visualization and quantitative analyzes of birefringence (Rheo-Iris)

Particle imaging velocimetry (PIV)

- Visualization of complex flow fields such as shear banding, turbulences, or flow instabilities
- Temperature range: 10 °C to 70 °C
- Variants for configurations with one EC motor (Searle mode) and two EC motors (Searle, Couette, and counter-movement modes)

Further accessories

- Small-angle light scattering (SALS):
- Investigation of shear-dependent shape and orientation of microstructure
 - Temperature range: -20 °C to +300 °C
 - Wide scattering angle allowing measurements in large size range
- Small-angle X-ray/neutron scattering (SAXS/WAXS/SANS):
- Nanostructure analysis
 - Modular, radiolucent convection oven from -50 °C to +300 °C

Applications

Biological fluids
Cosmetics
Crystallization
Emulsion droplets and capsules
Food

Biological samples
Chemical reactions
Crystallization
Morphology of polymers

Battery slurries and inks
Cellulose
Crystallization
Liquid crystals
Polymers
Surfactants

Applications

Adhesives
Biomaterials
Cosmetics
Paints
Polymers

Biological fluids
Colloids
Surfactant solution

Biomaterials
Colloids
Cosmetics
Crystallization
Food
Polymers
Surfactants
Suspensions

Extended Material Characterization

From starch behavior and interfacial rheology to particle flow and building materials, these advanced systems provide valuable insights for research, development, and quality control.



Starch cell

- Analysis of starch pasting behaviour and functionality of proteins
- Simulation of temperature and pressure condition of food production process
- Max. heating rate: 60 °C/min
- Max. cooling rate: 45 °C/min
- Optional starch pressure cell up to 30 bar and 160 °C

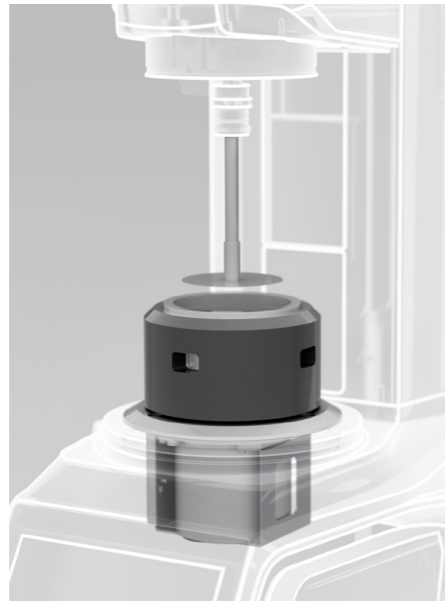

Interfacial rheology system (IRS)

- Rheological measurements of interface and surface layers
- Temperature range: 5 °C to 70 °C
- Measurement of even the weakest interfacial structures using the MCR low-torque capabilities and TruStrain feature
- Bi-cone and ring measurement systems
- Flow-through option available on request



Ball measuring system (BMS)

- Measurement of the flow properties of samples with large particles (1 mm to 10 mm)
- Temperature range: -10 °C to +70 °C
- Measuring principle: Eccentrically rotating ball-in-a-cup to avoid undesired slipping, gliding, and disturbing edges



Building material cell (BMC)

- Measurement of the flow properties of samples with large particles (1 mm to 10 mm)
- Temperature range: 0 °C to 90 °C
- Changeable, robust, and easy-to-clean cage and special stirrer
- Resistance to abrasive materials prevents sample slippage and provides improved mix-up effects to avoid separation

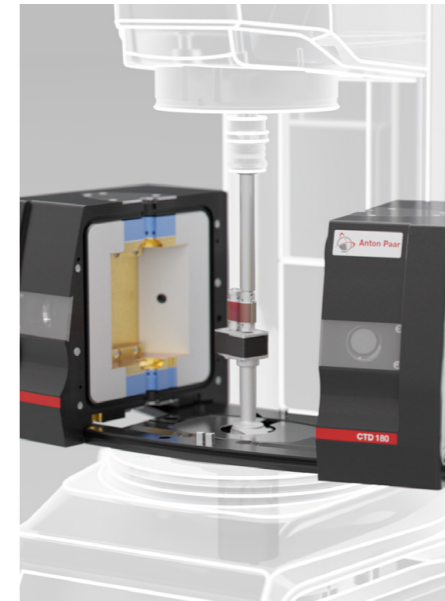

Extensional rheology

- Determination of extensional properties and information about molecular structure, branching, shrinkage, relaxations, and adhesion
- Universal extensional fixtures (UXF), patented UXF/TD (US Pat. 9766172) and Sentmanat Extensional Rheometer (SER) enabling film and fiber testing up to 350 °C
- Customized capillary extension system enabling characterization of complex fluids based on capillary breakup measurements



Bitumen rheology

- Specialized SmartPave Dynamic Shear Rheometers (DSR) for all applications, from daily routine tests to research tasks in the asphalt industry
- Compliant with a large number of standards (e.g., AASHTO, ASTM, EN, FGSV, IS, and AGPT)
- RheoCompass software includes standard operation procedures for a wide range of methods
- Temperature calibration procedure in combination with Peltier temperature control systems guarantees accurate results

Applications

Dairy products
Flour
Malt
Proteins
Starch

Detergents
Encapsulation
Eye drops
Food
Pharmaceutical and cosmetics

Food
Slurries
Suspensions

Applications

Cement
Concrete
Plaster
Sludges

Adhesives
Coatings
Inks
Melts and solutions
Polymer films

Asphalt additives
Asphalt binder
Bitumen
Bitumen emulsions
Mastics
Roofing shingles

More Than Just a Rheometer

Our MCR devices aren't just rheometers. They're characterization super-machines. They make tribological and powder characterization, dynamic mechanical analysis, and conventional mechanical testing possible.

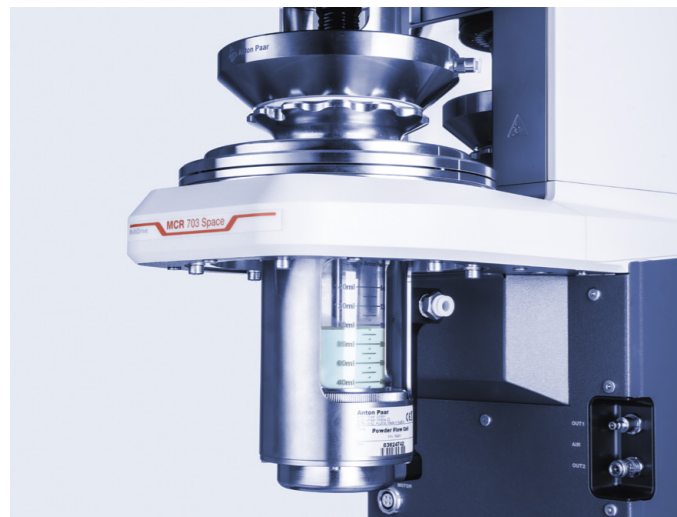

Powder testing

An MCR rheometer combined with the powder shear cell and powder flow cell enables comprehensive powder characterization. These unique cells ensure highly sensitive determination of powder behavior and deliver reliable results that can be applied throughout your entire process chain.



MCR tribometer

Employ the precise motion and normal force control of MCR tribometers for your tribological measurements. Expand your traditional tribological tests by opening up entirely new measuring ranges on a single instrument. Seamlessly measure breakaway forces or plot Stribeck curves over nine decades of sliding speeds.

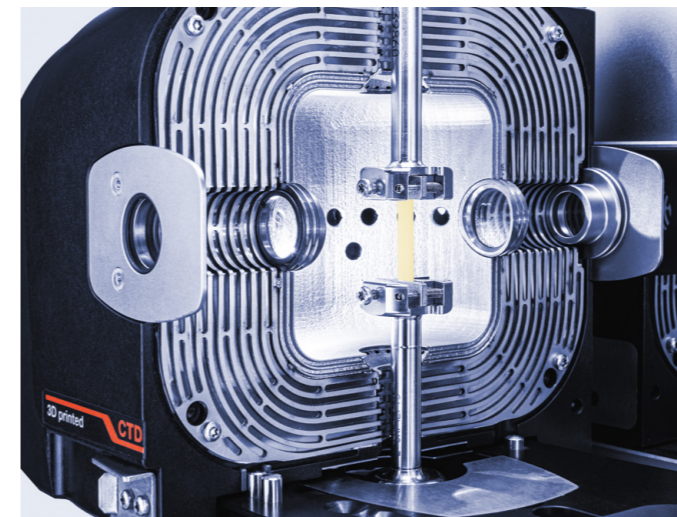

Dynamical mechanical analysis (DMA)

The MCR series enables precise determination of a material's modulus, stiffness, and damping behavior, as well as creep and relaxation of viscoelastic solids. It also provides crucial insights into glass and other key transitions, the influence of fillers, additives, water, and plasticizers, as well as compatibility, curing, and aging. DMA can be performed in tension, torsion, bending, compression, and even in combined axial-torsional modes.



Mechanical testing

Leverage the sensitivity and precision of our MCR technology for testing parts, components, or texture. The UTM Micro opens up a whole new world of low-force syringe testing and low-torque universal material testing. We all know traditional tack tests. Now you can also perform texture analysis; peel, puncture, and friction testing; flexure, torsion, tensile, and compression testing; as well as much more.

	MCR 303	MCR 503	MCR 503 Power	MCR 703 MultiDrive / MCR 703 Space MultiDrive Configuration with one EC motor	MCR 703 MultiDrive / MCR 703 Space MultiDrive Configuration with two EC motors
Bearing design	Air, fine-pored carbon				
Motor design	Electronically Commutated (EC) Permanent Magnet Synchronous Motor				
Displacement transducer	High-resolution optical encoder				
Normal Force measurement design	360° capacitive sensor, non-contacting, fully integrated in bearing				
Working modes	CMT			CMT, SMT, Counter-Movement ¹⁾	
Min. torque (rotation)	5 nNm	1 nNm	100 nNm	1 nNm	
Min. torque (oscillation)	5 / ¹²⁾ nNm	0.2 nNm	50 nNm	0.2 nNm	
Max. torque	215 mNm	230 mNm	300 mNm	230 mNm	
Torque resolution	0.1 nNm	0.05 nNm	0.2 nNm	0.05 nNm	
Angular deflection resolution	3 nrad	<1 nrad			
Min. angular velocity³⁾	0 rad/s				
Max. angular velocity / Max. speed	314 rad/s 3,000 rpm	200 rad/s 2,100 rpm	314 rad/s 3,000 rpm	628 rad/s 6,000 rpm	
Min. frequency⁴⁾	2 x 10 ⁻⁸ Hz				
Max. frequency	100 Hz	200 Hz			
Normal force range	0.001 N to 50 N	0.01 N to 70 N	0.001 N to 50 N		
Normal force resolution	0.1 mN				
TruStrain	○	✓	✓	✓	✓
Ready for DMA in tension, bending and compression⁵⁾	×	✓	✓	✓	✓
Ready for axial-torsional DMA⁵⁾	×	×	×	✓	✓
Dimensions (W x H x D)	453 mm x 725 mm x 673 mm	453 mm x 775 mm x 673 mm		MCR 703 MultiDrive: 453 mm x 775 mm x 673 mm MCR 703 Space MultiDrive: 300 mm x 775 mm x 584 mm MCR 703 Space electronics box: 333 mm x 231 mm x 576 mm	
Weight	48 kg	50 kg		MCR 703 MultiDrive: 50 kg MCR 703 Space MultiDrive: 52 kg MCR 703 MultiDrive: 60 kg MCR 703 Space MultiDrive: 62 kg MCR 703 Space electronics box: 16 kg	

Trademarks: RheoCompass (9177015), MultiDrive (16731581), TwinDrive Rheometry (7081128), SmartPave (16731556), T-Ready (9176983), Toolmaster (3623873), TruRate (9176967), TruRay (15273915), TruStrain (9176918)

Patents: US Pat. 8453496, 9766172, 9574983, 10908058, 8132445, 10031057, 9702809, AT Pat. 513661, DE Pat. 102015100714

✓ Included ○ Optional × Not included

- 1) US Pat. 8453496
- 2) 1 nNm with activated TruStrain™ option
- 3) In controlled shear stress (CSS) mode. In controlled shear rate (CSR) mode depending on measuring point duration and sampling rate
- 4) Theoretical value (duration per cycle = 2 years)
- 5) US Pat. 9574983 and US Pat. 10908058

The Rheo Academy



Find out more

Sign up for our rheology courses and webinars

We regularly offer courses at our global subsidiaries and also organize online courses or exclusive group courses for customers on request.

Learn the basics of rheology, optimize your work with the RheoCompass software, and gain application-specific knowledge. You can also learn more about specialist subjects and meet our experts for discussions online by taking part in one of our free webinars.

Enjoy access to an extensive database of knowledge

As a customer, enjoy access to a large database of useful application reports, product documentation, and tutorial videos. Benefit from our comprehensive background knowledge on rheological theory (e.g., through our wiki and the book *Applied Rheology* by renowned expert Thomas Mezger).

Get in touch with our experts

We provide excellent service and support. With Anton Paar subsidiaries and numerous partners worldwide, a rheological expert is close to you and happy to help. Call us for advice on test definitions or to discuss the rheological challenges you're facing.



Reliable. Compliant. Qualified.



Our well-trained and certified technicians are ready to keep your instrument running smoothly.

Maximum uptime | Warranty program | Short response times | Global service network

