

# Endstop

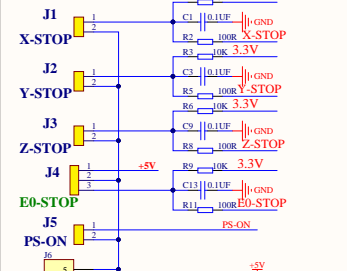

# ARM-CPU

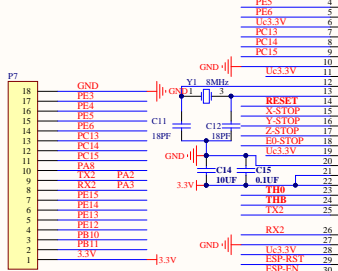

## E3 RRF V1.1

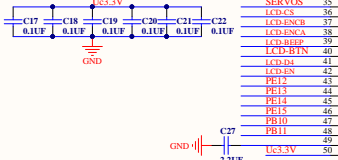

# Thermistor

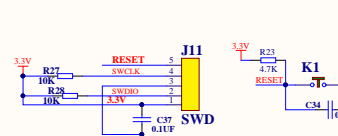
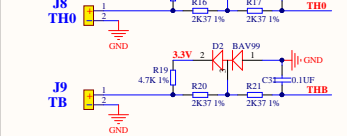

# Display

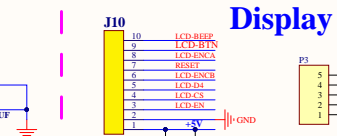

# EEPROM

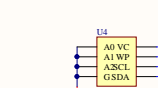

# Supply

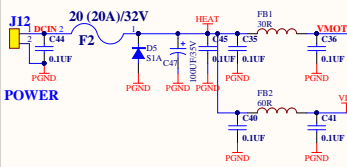

# DCDC 5V

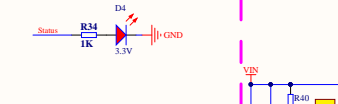

# DCDC3.3V

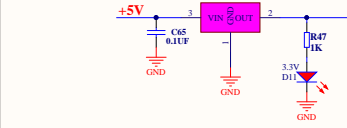

# DCDC 5V

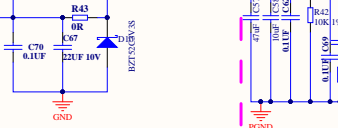

# MOS

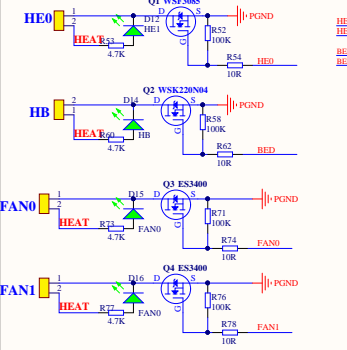

# WIFI

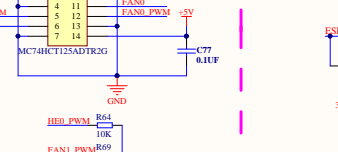

# USB

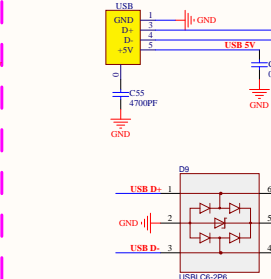

# SD-Card

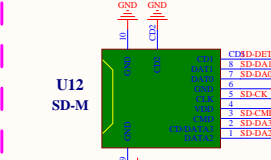

# [E0]

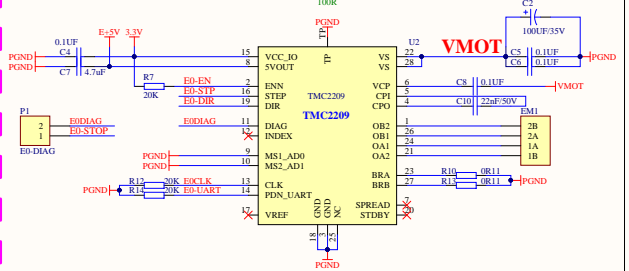

# [X]

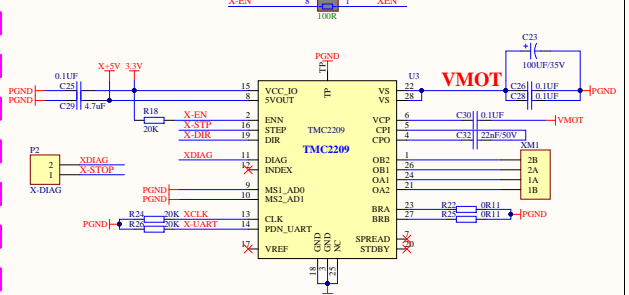

# [Y]

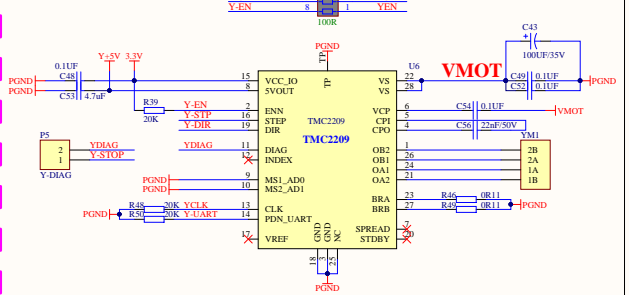

# [Z]

