

## UNIT - I

### CONTROL OF DC MOTORS BY LINE COMMUTATED CONVERTERS

**Power Semi-conductor Drives:** It is a course that deals with single phase and three phase converter based dc motor control, chopper based control of dc motors.

It also deals with dc drives for quadrant operation.

**Electric Drive:** The combination of equipment to convert one form of energy to another form of energy and to provide a control for this process is called electric drive.

The electric drive mainly consists of source, power modulator, motor, load and control unit.

Block diagram of electric drive is as shown below.

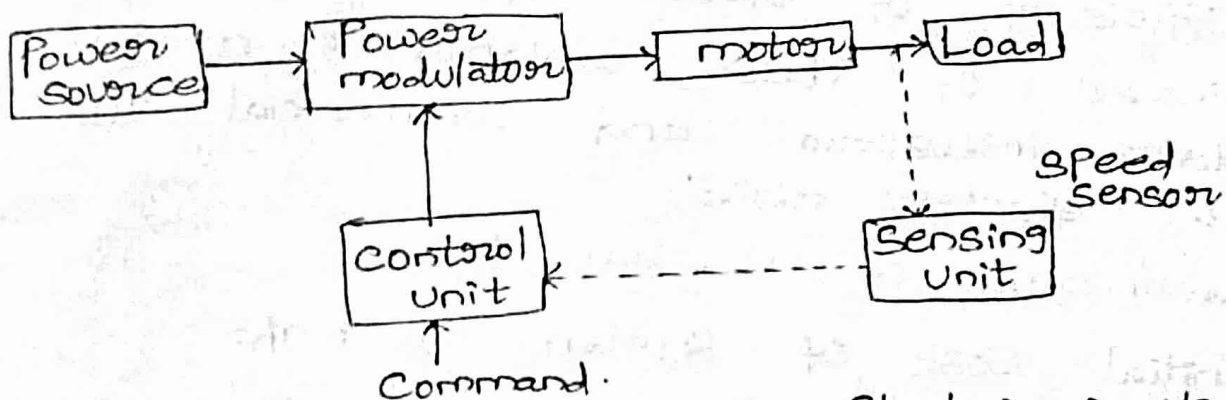

Fig. Block representation of Electric Drive.

1. Power source: The power source may be either ac or dc as per the requirement.

2. Power modulator:

Depending upon the choice of source and motor, the power modulator was chosen.

It converts one form of energy into another form.

Ex: Rectifier, Inverter, chopper, cycloconverter etc...

3. Control Unit: It is mainly used to control the power modulator.

It is used for the safe operation of motor as well as power modulator.

4. Sensing unit: It senses drive parameters like motor current and speed. It is mainly required for protection and for closed loop operation.

Advantages of Electric Drive:

1. Electric drive has very large range of torque, speed and power.
2. Their working is independent of the environmental condition and are free from pollution.
3. They can be easily started.

4. Electric drive possesses four quadrant operation of speed-torque plane.

5. Efficiency of electric drive is high.

Because of these advantages all the modern industrial and commercial application employ electric drive.

Disadvantages of Electric Drive:

1. Initial cost of system is high.
2. It has poor dynamic response.
3. It can cause noise pollution.
4. Output power obtained from drive is low.

Applications: Electric drives are widely used in industrial and domestic applications like

1. Transportation systems,
2. Rolling mills, textile mills
3. Paper machines.
4. Fans, pumps



Controlled Converters are classified into two types. They are:

1. Single Phase Converters
2. Three Phase Converters.

1. Single Phase Converters: These are of two types:

- (i) Single Phase <sup>(semi)</sup> half Controlled Converter.
- (ii) Single Phase fully Controlled Converter.

2. Three Phase Converters:

- (i) Three Phase <sup>(semi)</sup> half Controlled Converter.
- (ii) Three Phase fully Controlled Converter.

Single Phase semi controlled converter connected to DC separately excited motor:

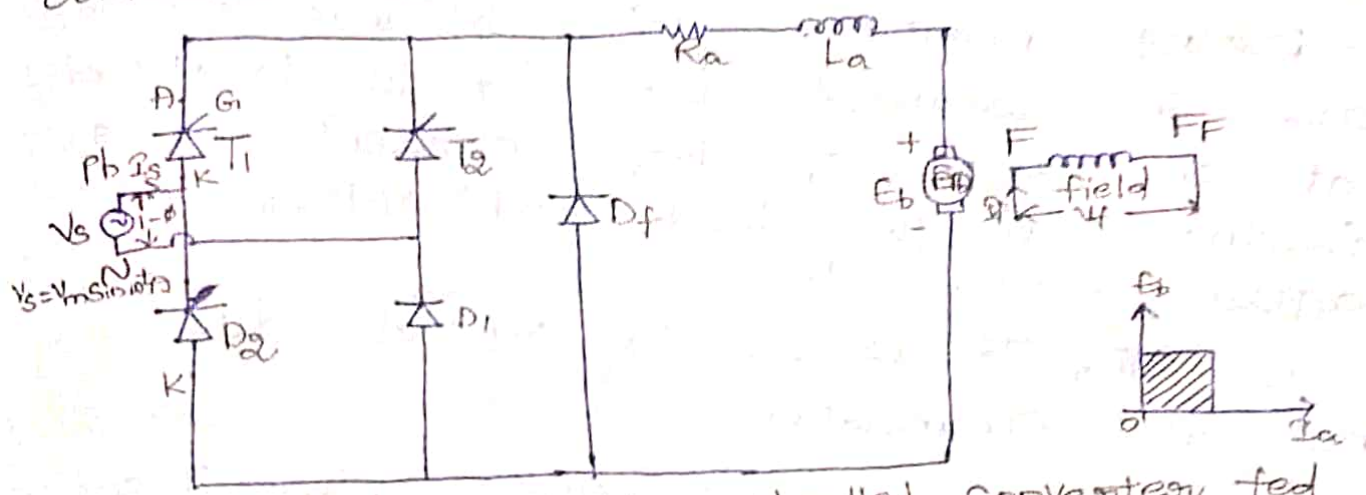

Fig. Single Phase semi controlled converter fed DC separately excited motor (It is single quadrant converter)

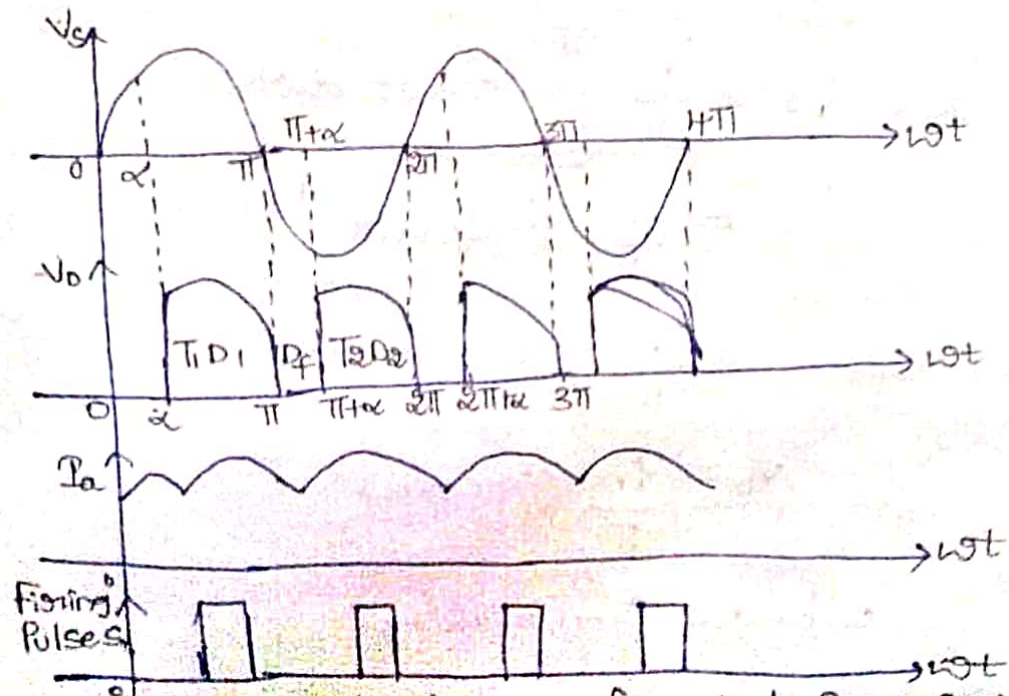

Fig. wave forms for 1-φ Semi Converter.

The circuit diagram, quadrant operation and wave forms for single phase semi controlled converter fed separately excited DC motor is shown in figure.

Total number of thyristors in this converter are two and total number of diodes are two.

During positive half cycle,  $T_1$  and  $D_1$  are in forward bias.  $T_1$  is triggered at an angle of  $\alpha$ , current starts flowing through the load and voltage will appear across load.

At  $\pi$ ,  $T_1$  comes to off state due to natural commutation.

During negative half cycle,  $T_2$  and  $D_2$  are in forward bias.  $T_2$  is triggered at an angle of  $\pi + \alpha$ , current starts flowing through load and voltage will appear across load.

At  $2\pi$ ,  $T_2$  comes to off state due to natural commutation.

For one cycle of output, two pulses are obtained. Hence it is a two pulse converter.

$$\text{Output Voltage, } V_o = \frac{1}{\pi} \int_{\alpha}^{\pi} V_m \sin \omega t \cdot d\omega t$$

$$= \frac{V_m}{\pi} [-\cos \omega t]_{\alpha}^{\pi}$$

$$= \frac{V_m}{\pi} [-\cos \pi + \cos \alpha]$$

$$V_o = \frac{V_m}{\pi} (1 + \cos \alpha)$$

where  $V_m = \sqrt{2} V_s$ .



# Speed - Torque Characteristics:

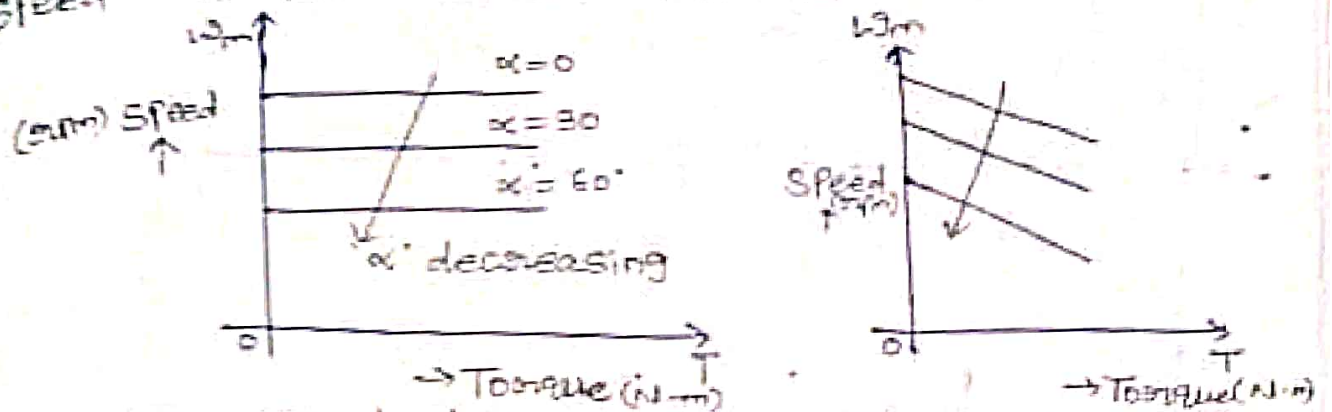

Fig. Speed - torque Characteristics:

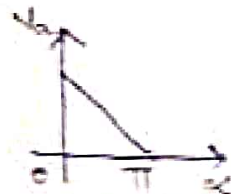

Fig. Variation of output voltage as function of firing angle.

We know that, For separately excited DC motor,

$$\text{Back emf, } E_b = V_0 - I_a R_a$$

$$\text{But } E_b = K_m \cdot \omega_m$$

$$\Rightarrow K_m = \frac{E_b}{\omega_m} \text{ Volt} \frac{\text{sec}}{\text{rad}} / \text{sec}$$

$$\text{Developed Torque } T = K_a \phi I_a \text{ N-m}$$

$$\Rightarrow I_a = \frac{T}{K_a \phi}$$

$$\text{Speed } N = \frac{V_0 - I_a R_a}{K_a \phi} \text{ rad/sec}$$

Single Phase Fully Controlled converter, Connected to separately excited DC motor:

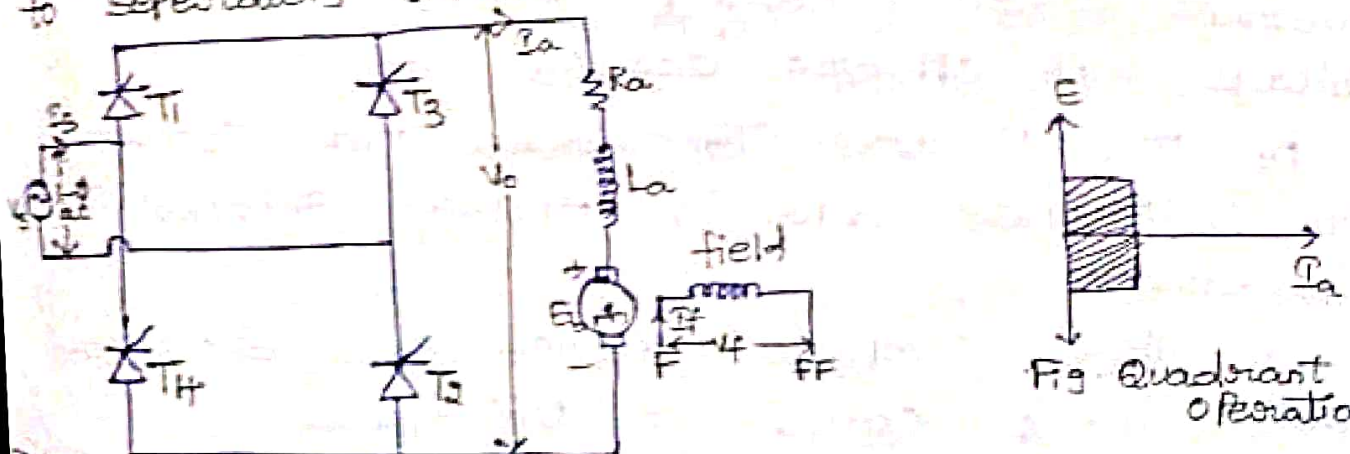

Fig. Quadrant operation.

Fig. 1- $\phi$  fully converter fed separately excited DC motor.

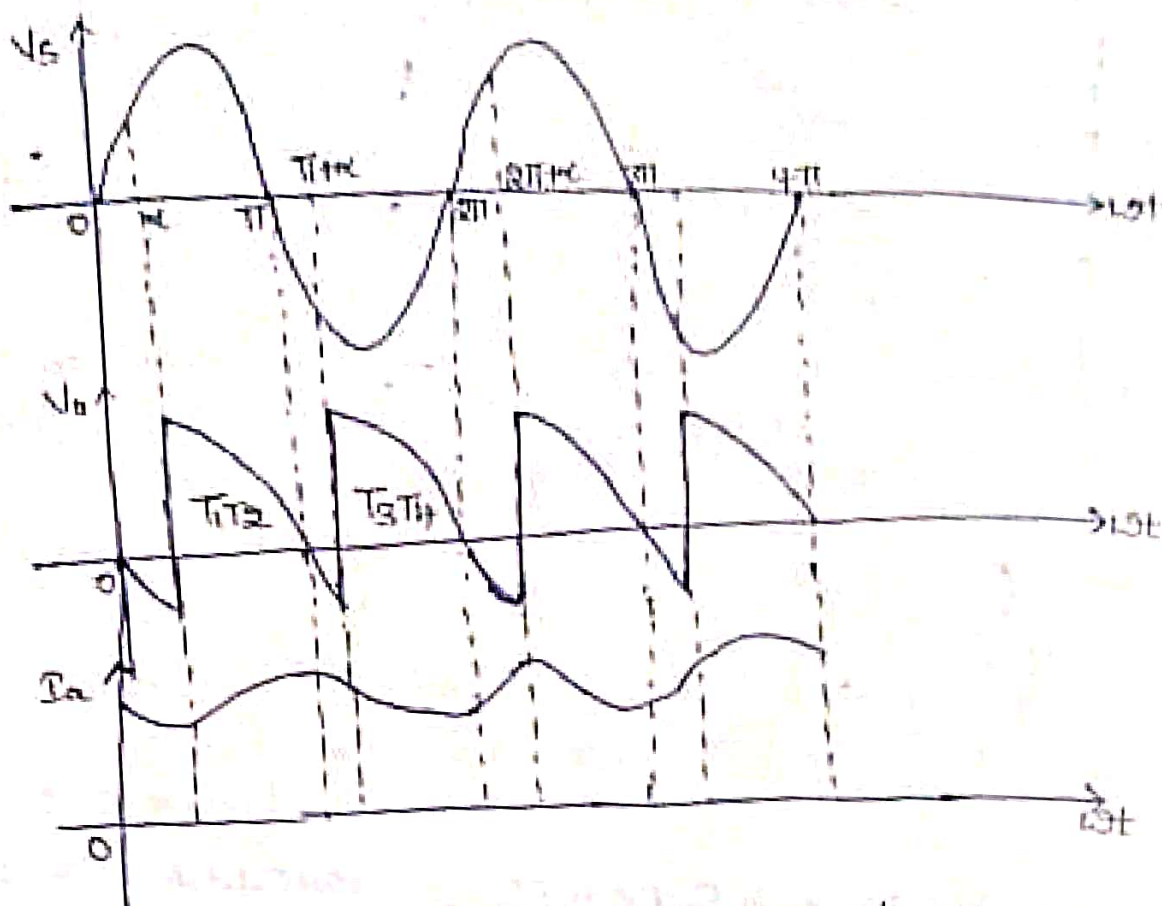

Fig. waveforms for single phase fully controlled converter fed separately excited DC motor.

Circuit diagram, quadrant operation and waveforms for single phase half converter fed separately excited DC motor is shown in figure.

It is a two-quadrant converter.

Total number of thyristors in this converter are four. Thyristors are triggered in sequence based upon their numbering.

During positive half cycle  $T_1$  and  $T_2$  are in forward bias and triggered at an angle  $\alpha$ , current starts flowing through load and voltage will appear across load.

At  $\pi$ ,  $T_1$  and  $T_2$  does not come to off state due to energy stored in inductor.

At  $\pi + \alpha$ , complete energy gets dissipated and  $T_1, T_2$  comes to off state.



During reactive half cycle  $T_a$  and  $T_b$  are  
 forward bias and triggered at an  
 angle  $\alpha$ . This current starts flowing through  
 load and voltage will appear across load  
 at  $\alpha$ .  $T_a$  and  $T_b$  does not comes to off  
 state due to energy stored in inductor.  
 At  $\pi + \alpha$ , complete energy gets dissipated  
 and  $T_a, T_b$  comes to off state.

It was observed that for one cycle of  
 input, two pulses were obtained.  
 Hence it is a two pulse converter.

output voltage, 
$$V_o = \frac{1}{\pi} \int_{\alpha}^{\pi+\alpha} V_m \sin \omega t \, d\omega t$$

$$= \frac{V_m}{\pi} [-\cos \omega t]_{\alpha}^{\pi+\alpha}$$

$$= \frac{V_m}{\pi} [-\cos(\pi+\alpha) + \cos \alpha]$$

$$= \frac{V_m}{\pi} [(-(-\cos \alpha)) + \cos \alpha]$$

$$= \frac{V_m}{\pi} [2 \cos \alpha]$$

$$V_o = \frac{2V_m}{\pi} \cos \alpha \text{ where } V_m = \sqrt{2} V_s$$

Speed - Torque characteristics:

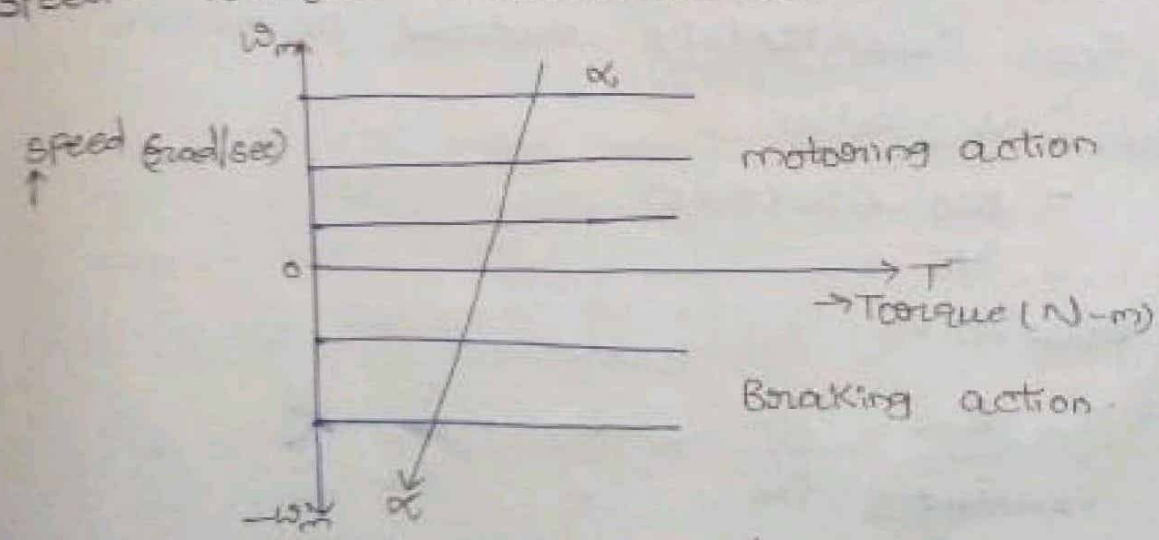

Fig. Speed Vs Torque characteristics.

For Separately excited motor,  
Output Voltage,  $V_o = \frac{2V_m \cos \alpha}{\pi}$

$$\text{Back emf, } E_b = V_o - I_a R_a$$

$$\text{But } E_b = K_m \omega_m$$

$$K_m = \frac{E_b}{\omega_m}$$

$$K_m = K_a \phi \text{ Volt sec/rad}$$

$$\text{Developed Torque, } T = K_a \phi I_a$$

$$\text{Speed, } N = \omega_m = \frac{V_o - I_a R_a}{K_a \phi} \text{ rad/sec}$$

Problems:

1. A 220V, 875 rpm, 150A Separately excited DC motor has  $R_a = 0.06 \Omega$ . It is fed from Single phase fully controlled rectifier. Calculate

- (i) Firing angle for rated motor torque at  $-500 \text{ rpm}$
- (ii) Find speed at  $160^\circ$  at rated torque
- (iii) Calculate firing angle at 750 rpm for rated motor torque

Sol Given data,

$$V_s = 220V$$

$$I_a = 150A$$

(i) Given,

$$N_1 = 875 \text{ rpm/sec, } N_2 = -500 \text{ rpm}$$

w.k.t, For Separately excited DC motor,

$$E_{b1} = V_o - I_a R_a$$

$$= 220 - (150 \times 0.06)$$

$$= 220 - 9$$

$$E_{b1} = 211V$$

$$\text{w.k.t, } \frac{E_{b1}}{E_{b2}} = \frac{N_1}{N_2}$$

$$\Rightarrow \frac{211}{E_{b2}} = \frac{875}{-500}$$



$$\Rightarrow 211 \times -500 = 875 E_{b2}$$

$$\Rightarrow E_{b2} = \frac{211 \times -500}{875} = -120.571 \text{ V}$$

$$E_{b2} = V_0 - I_a R_a$$

$$V_0 = E_{b2} + I_a R_a$$

$$\frac{2V_m \cos \alpha}{\pi} = -120.571 + 150 \times 0.06$$

$$\frac{2\sqrt{2} \times 220}{\pi} \cos \alpha = -111.571$$

$$198.069 \cos \alpha = -111.571$$

$$\cos \alpha = \frac{-111.571}{198.069} \Rightarrow \alpha = \cos^{-1} \left( \frac{-111.571}{198.069} \right)$$

$$\alpha = 124.283^\circ$$

(ii) Speed at 160% at stated torque:

$$\text{W.K.T.}, V_0 = \frac{2V_m \cos \alpha}{\pi}$$

$$V_m = \sqrt{2} V_s = \sqrt{2} \times 220 = 311.126 \text{ V}$$

$$V_0 = \frac{2 \times 311.126 \cos(160^\circ)}{\pi} = -186.124 \text{ V}$$

$$\text{W.K.T.}, E_{b2} = V_0 - I_a R_a$$

$$= -186.124 - (150 \times 0.06) = -195.124 \text{ V}$$

$$\frac{E_{b1}}{E_{b2}} = \frac{N_1}{N_2} \Rightarrow N_2 = \frac{E_{b2} \times N_1}{E_{b1}} = \frac{875 \times -195.124}{211}$$

$$N_2 = -809.163 \text{ rpm}$$

$$N_2 = -809.163 \times \frac{2\pi}{60}$$

$$= -84.73 \text{ rad/sec}$$

$$(iii) \frac{E_{b1}}{E_{b2}} = \frac{N_1}{N_2}$$

$$\Rightarrow E_{b2} = \frac{E_{b1} \times N_2}{N_1} = \frac{211 \times 750}{875} = 180.85 \text{ V}$$

$$E_{b2} = V_0 - I_a R_a \Rightarrow V_0 = E_{b2} + I_a R_a$$

$$= 180.85 + 150 \times 0.06$$

$$V_0 = 189.85 \text{ V}$$

$$\Rightarrow \frac{2V_m}{\pi} \cos \alpha = 189.85V$$

$$\cos \alpha = \frac{189.85}{\frac{2V_m}{\pi}}$$

$$\alpha = \cos^{-1} \left( \frac{189.85}{\frac{2\sqrt{2} \times 220}{\pi}} \right) = \cos^{-1} \left( \frac{189.85}{198.069} \right)$$

$$\alpha = 16.563^\circ$$

2. A 220V, 1500 rpm, 10A Separately excited dc motor is controlled by single phase bridge rectifier with  $R_a = 1.2 \Omega$ . 230V, 50Hz AC supply. Calculate

(i) Speed for firing angle of  $30^\circ$  and torque of 5 N-m.

Sol Given data,

$$V_o = 220V$$

$$I_a = 10A$$

$$R_a = 1.2 \Omega$$

$$\text{w.k.T, } E_b = V_o - I_a R_a = 220 - (10 \times 1.2) \\ = 220 - 12 = 208V$$

$$\text{Torque, } T = K_a \phi I_a = K_m I_a$$

$$\Rightarrow I_a = \frac{T}{K_m}$$

$$E_b = K_m \omega_m \Rightarrow K_m = \frac{E_b}{\omega_m} = \frac{208}{157.07}$$

$$= 1.324 \text{ Voltsec/rad}$$

$$N = 1500 \text{ rpm} = 1500 \times \frac{2\pi}{60} = 157.07 \text{ rad/sec}$$

$$\therefore I_a = \frac{5}{1.324} = 3.776A$$



$$E_{b2} = V_0 - I_a R_a = \frac{2V_m}{\pi} \cos \alpha - I_a R_a$$

$$= \frac{2\sqrt{2} \times 230}{\pi} \cos(20^\circ) - (2.716 \times 1.2)$$

$$= 167.002 \text{ V}$$

$$\frac{E_{b1}}{E_{b2}} = \frac{N_1}{N_2} \Rightarrow N_2 = \frac{E_{b2} \cdot N_1}{E_{b1}} = \frac{167.002 \times 1500}{208}$$

$$N_2 = 1204.341 \text{ rpm} = 1204.341 \times \frac{2\pi}{60}$$

$$N_2 = 126.112 \text{ rad/sec}$$

(ii) Calculate developed torque for a firing angle of  $45^\circ$  and speed of 1000 rpm.

Rated speed, current and voltage means

$K_m$  is same i.e.  $K_m = 1.324 \text{ voltsec/rad}$ .

$$V_0 = \frac{2V_m}{\pi} \cos \alpha = \frac{2\sqrt{2} \times 230}{\pi} \cos(45^\circ) = 146.42 \text{ V}$$

$$E_b = V_0 - I_a R_a = K_m \omega_m$$

$$\omega_m = 1000 \text{ rpm} = 1000 \times \frac{2\pi}{60} = 104.719 \text{ rad/sec}$$

$$E_b = 104.719 \times 1.324 = 138.648 \text{ V}$$

$$E_b = V_0 - I_a R_a$$

$$V_0 = E_b + I_a R_a$$

$$V_0 - E_b - I_a R_a = 0$$

$$V_0 - E_b = I_a R_a$$

$$I_a = \frac{V_0 - E_b}{R_a} = 6.48 \text{ A}$$

# Generalised Analysis:

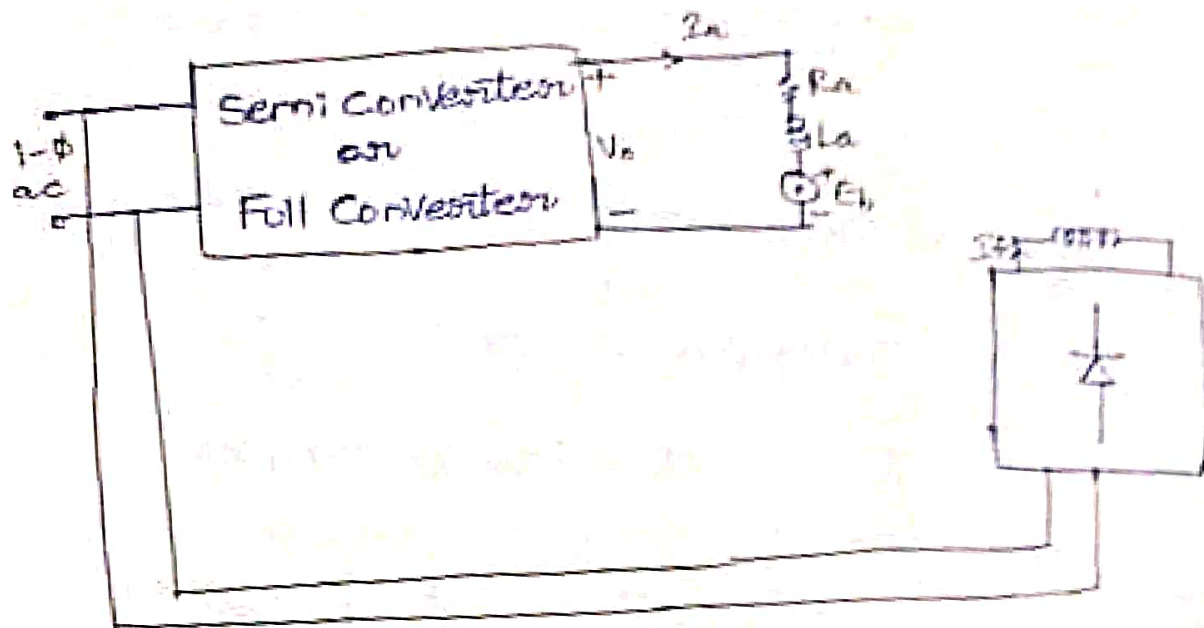

From Figure,

$$\text{Back Voltage or emf} = K_a \Phi \omega$$

$$\text{Average Back emf, } E_g = K_a \Phi N$$

' $\alpha$ ' on Armature side, we get speed control below rated speed.

' $\alpha$ ' control vary on field side, speed control above rated speed obtained.

$$\text{Developed torque } T = K_a \Phi I_a$$

$$\text{Average developed torque } T = K_a \Phi I_a$$

Armature circuit voltage equation is

$$E_a = R_a I_a + L_a \frac{dI_a}{dt} + E_g$$

In terms of average values,

$$E_a = E_g + I_a R_a$$

$$N = \frac{E_a - I_a R_a}{K_a \Phi} \text{ rad/sec}$$



# Single Phase Semi Converter, Connected to Series DC motor:

It is Single Quadrant Converter. Circuit diagram, quadrant operation and waveforms for Single Phase Semi Converter fed Series DC motor is shown below.

$$0 \leq \omega t \leq \pi \rightarrow V_o = +V_c$$

$$\pi \leq \omega t \leq 2\pi \rightarrow V_o = 0$$

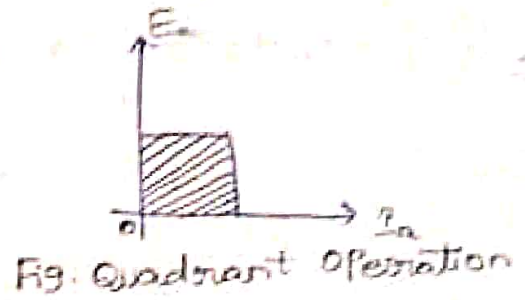
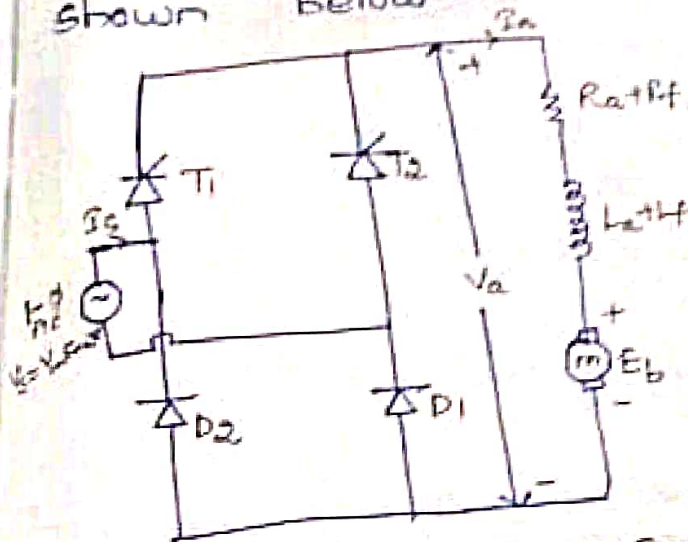

Fig. Single Phase Semi Converter fed DC Series motor

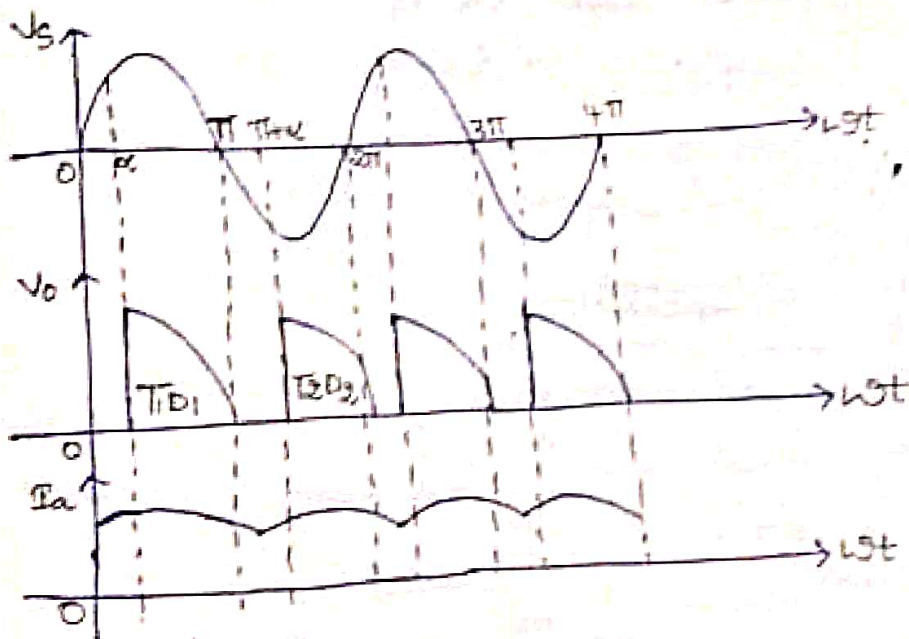

Fig. waveforms.

Total number of thyristors in this converter are two and total number of diodes are two.

During positive half cycle  $T_1$  and  $D_1$  are in forward bias and  $T_1$  is triggered at an angle  $\alpha$ , current start flowing through load and voltage will appear across load.

At  $\pi$ ,  $T_1$  and  $D_1$  come to off state due to natural commutation.

During negative half cycle  $T_2$  and  $D_2$  are in forward bias and  $T_2$  is triggered at an angle  $\pi + \alpha$ , consistent about flowing through  $D_2$  and voltage will appear across the load. At  $2\pi$ ,  $T_2$  and  $D_2$  comes to off state due to natural commutation.

It was observed that for one cycle of input, two pulses were obtained. Hence it is a two pulse converter.

Output Voltage, 
$$V_o = \frac{1}{\pi} \int_{\alpha}^{\pi} V_m \sin \omega t \cdot d\omega t$$

$$= \frac{V_m}{\pi} [-\cos \omega t]_{\alpha}^{\pi}$$

$$= \frac{V_m}{\pi} [-\cos \pi + \cos \alpha]$$

$$V_o = \frac{V_m}{\pi} [1 + \cos \alpha]$$

Where  $V_m = \sqrt{2} V_s$

Characteristics:

Speed - Torque

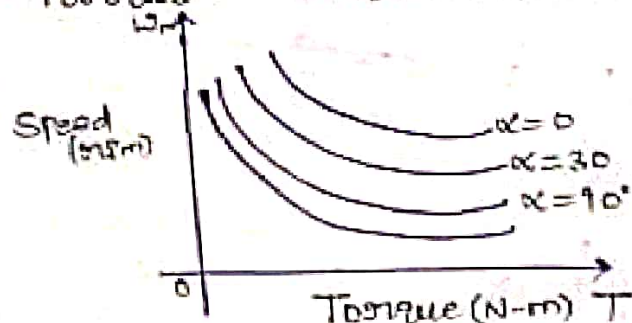

Fig. Torque speed characteristics for single phase semi converter fed DC series motor.

We know that,

Back EMF,  $E_b = K_a \phi N$

For series motor,

Total flux = Armature flux + Residual flux

i.e.  $\phi = \phi_a + \phi_{res}$

But  $\phi_a = K_f \cdot I_a$

$\phi_{res} = K_{res} I_a$

$\therefore E_b = K_a (K_f + K_{res}) I_a \cdot N$



$$E_b = K_a (\phi_a + \phi_{se}) N$$

$$= K_a K_f I_a N + K_a K_{res} N$$

$$E_b = K_{af} I_a N + K_{res} N \rightarrow \textcircled{1}$$

where  $K_{af} = K_a K_f$  and  $K_{res} = K_a K_{res}$

$$E_b = V_o - I_a (R_a + R_f) \rightarrow \textcircled{2}$$

From  $\textcircled{1}$  and  $\textcircled{2}$ ,

$$V_o = I_a (R_a + R_f) + K_{af} I_a N + K_{res} N$$

Torque,  $T = K_{af} I_a$

$$\phi = \phi_a + \phi_{se}$$

$$T_a = K_{af} I_a^2 \Rightarrow I_a = \sqrt{\frac{T_a}{K_{af}}}$$

$$T \propto I_a^2$$

$$\therefore \text{Speed} \Rightarrow N = \frac{V_o - I_a (R_a + R_f)}{K_{af} I_a + K_{res}}$$

$$T = K_{af} \left[ \frac{\frac{V_m}{\pi} (1 + \cos \alpha) - K_{res} N}{R_a + R_f + K_{af} N} \right]^2$$

$$= K_{af} \left[ \frac{V_o - K_{res} N}{R_a + R_f + K_{af} N} \right]^2$$

Single phase Fully controlled Converter Connected to DC series motor:

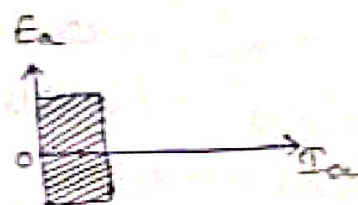
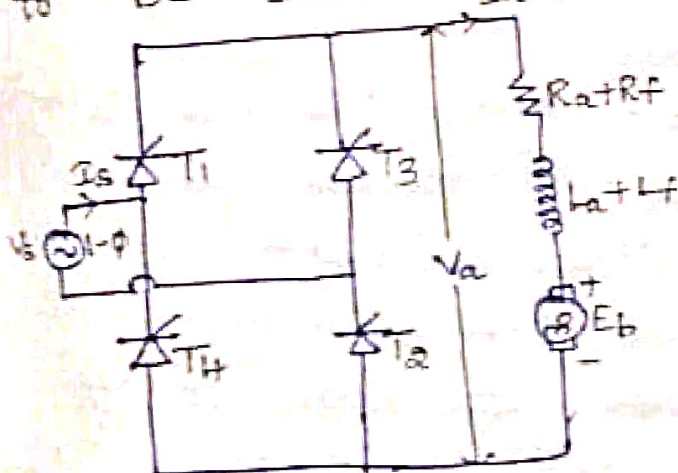

Fig. Quadrant operation.

Fig. Single phase fully controlled Converter fed DC series motor

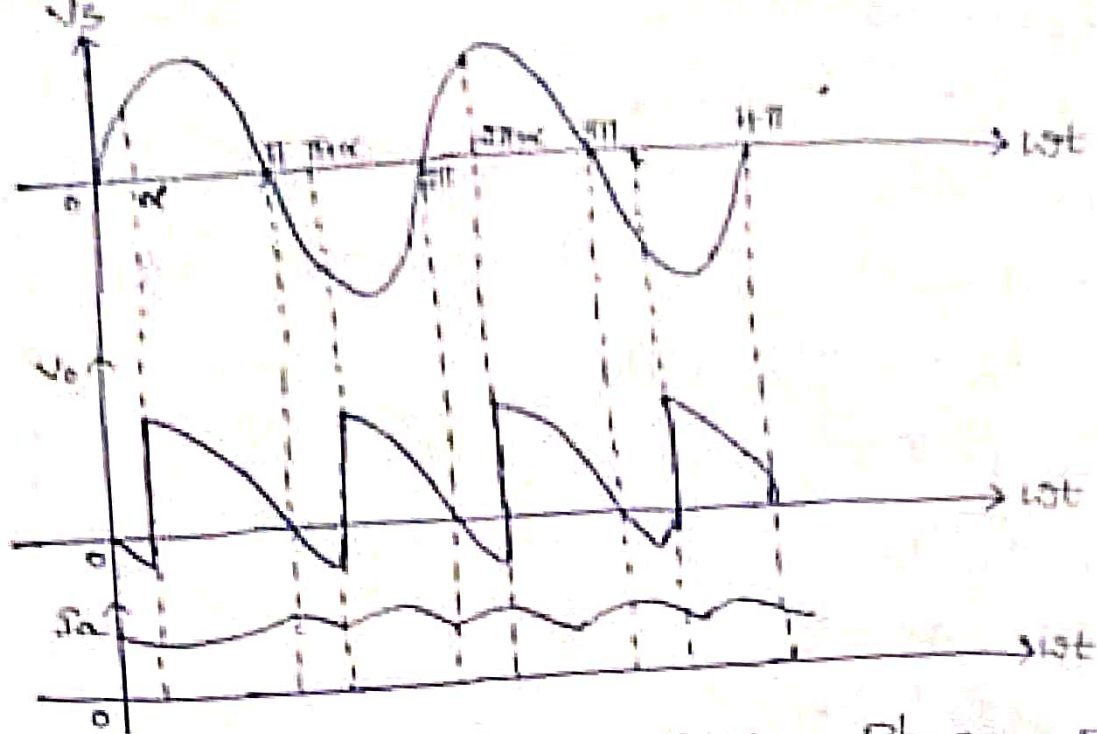

Fig. waveforms for single phase fully converter fed DC series motor.

It is a two quadrant converter. Total number of thyristors in this converter are four.

During positive half cycle thyristors  $T_1$  and  $T_2$  are in forward bias and triggered at an angle  $\alpha$ , current start flowing through load and voltage will appear across load.

At  $\pi$ ,  $T_1$  and  $T_2$  does not come to off state due to energy stored in inductor.

At  $\pi + \alpha$ ,  $T_1$  and  $T_2$  comes to off state due to natural commutation.

During negative half cycle,  $T_3$  and  $T_4$  are in forward bias and triggered at an angle  $\pi + \alpha$ , current start flowing through load and voltage will appear across load.

At  $2\pi$ ,  $T_3$  and  $T_4$  does not come to off state due to energy stored in inductor.

At  $2\pi + \alpha$ ,  $T_3$  and  $T_4$  comes to off state due to natural commutation.



It was observed that for one cycle of input two pulses were obtained. Hence it is a two pulse converter.

$$\begin{aligned} \therefore \text{output voltage, } V_o &= \frac{1}{\pi} \int_{\alpha}^{\pi+\alpha} V_m \sin \omega t \, d\omega t \\ &= \frac{V_m}{\pi} [-\cos \omega t]_{\alpha}^{\pi+\alpha} \\ &= \frac{V_m}{\pi} [-\cos(\pi+\alpha) + \cos \alpha] \\ V_o &= \frac{2V_m}{\pi} \cos \alpha \end{aligned}$$

Torque - speed characteristics:

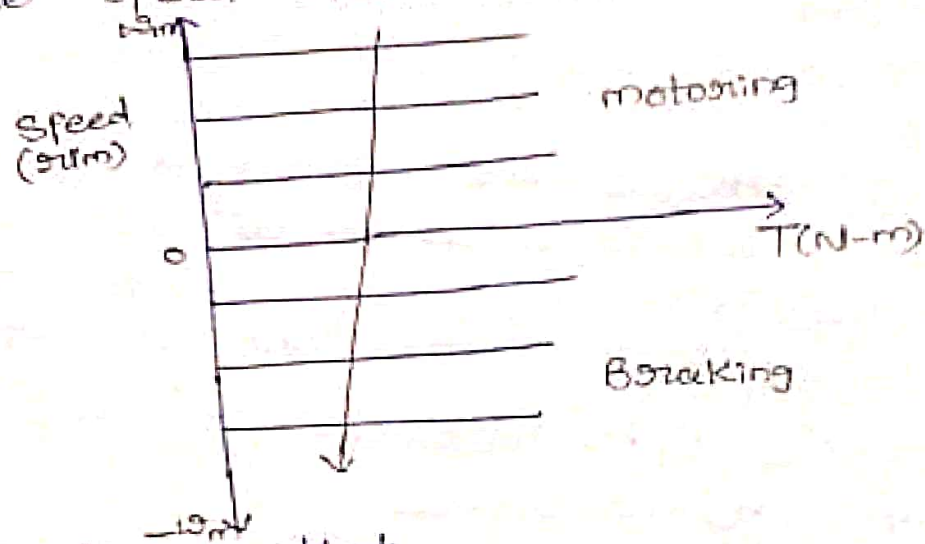

we know that,  
 $E_b = K_a \phi N$

$$\text{But } \phi = \phi_a + \phi_{res}$$

$$\phi_a = K_f \cdot I_a$$

$$\phi_{res} = K_{res}$$

$$\begin{aligned} \therefore E_b &= K_a(\phi_a + \phi_{res}) \cdot I_a \cdot N \\ &= K_{af} I_a \cdot N + K_{res} \cdot N \rightarrow \textcircled{1} \end{aligned}$$

$$E_b = V_o - I_a(R_a + R_f) \rightarrow \textcircled{2}$$

From  $\textcircled{1}$  and  $\textcircled{2}$ , we get

$$V_o = I_a(R_a + R_f) + K_{af} I_a \cdot N + K_{res} \cdot N$$

Developed torque,  $T = K_a \phi \cdot I_a$

$$\therefore T_a = K_{af} \cdot I_a^2$$

$$T \propto I_a^2$$

$$\text{Speed } N = \frac{V_o - I_a(R_a + R_f)}{K_{af} I_a + K_{res}}$$

$$T = K_{af} \left[ \frac{V_o - K_{res} N}{R_a + R_f + K_{af} N} \right]^2$$

Problems:

1. The speed of 250V, 900 rpm dc series motor is controlled by a single phase semi-converter. The total field and armature circuit resistance is 0.3Ω. The motor constants being  $K_{af} = 0.03 \text{ Nm/A}^2$  and  $K_{res} = 0.075 \text{ V/rad}$ , find the motor torque and motor current if the firing angle of thyristors in semi-converter is 30°. The motor operates at 1000 rpm and input supply voltage is 250V ac. Also obtain motor terminal voltage.

Sol Given that 1-φ semi-converter,

$$V_s = 250 \text{ V}, \quad R_a + R_f = 0.3 \Omega$$

$$\text{output voltage, } V_o = \frac{V_m (1 + \cos \alpha)}{\pi}$$

$$= \frac{\sqrt{2} \times 250 (1 + \cos 30^\circ)}{\pi}$$

$$V_o = 200 \text{ V}$$

$$\text{Speed } N = 900 \text{ rpm} = 900 \times \frac{2\pi}{60} = 94.24 \text{ rad/sec}$$

$$\text{W.K.T, } \frac{T}{I_a} = \frac{V_o - K_{res} N}{K_{af} N + R_a + R_f}$$

$$\Rightarrow I_a = \frac{V_o - K_{res} N}{K_{af} N + R_a + R_f} = \frac{200 - 0.075 \times 94.24}{0.03 \times 94.24 + 0.3}$$

$$I_a = 61.694 \text{ A}$$



$$\tau = K_{af} \cdot I_a^2 = 0.027 (61.694)^2 = 114.124 \text{ N-m}$$

Terminal Voltage,  $E_b = V_o - I_a(R_a + R_f)$

$$E_b = 200 - 61.694 \times 0.3$$

$$E_b = 181.49 \text{ V}$$

2. A DC Series motor has  $R_a = 3\Omega$ ,  $R_f = 3\Omega$ ,  $K_{af} = 0.15 \text{ V/rad}$ . motor speed is controlled by single phase semi-converter, firing angle is  $45^\circ$ , speed of motor is 1450 rpm, applied voltage is  $300 \sin \omega t$ . Find steady state motor current and Torque.

Sol Given that 1- $\phi$  semi converter fed DC series motor.

$$V_o = \frac{V_m}{\pi} (1 + \cos \alpha), \quad \alpha = 45^\circ, \quad R_a = 3\Omega, \quad R_f = 3\Omega$$

$$V_s = V_m \sin \omega t = 300 \sin \omega t \Rightarrow V_m = 300 \text{ V}$$

$$\therefore V_o = \frac{300}{\pi} (1 + \cos 45) = 179.318 \text{ V}$$

$$\text{motor current, } I_a = \frac{V_o - K_{res} \cdot N}{R_a + R_f + K_{af} \cdot N}$$

$$N = 1450 \text{ rpm} = 1450 \times \frac{2\pi}{60} = 151.843 \text{ rad/sec}$$

Note: ~~res~~  $K_{res}$  not given. Hence it neglected.

$$\therefore I_a = \frac{179.318}{3+3+0.15 \times 151.843} = 6.231 \text{ A}$$

Torque,  $\tau = K_{af} \cdot I_a^2$

$$= 0.15 \times (6.231)^2$$

$$\tau = 5.823 \text{ N-m}$$

3. A 220V, 1000 rpm, 10A dc series motor has  $R_a + R_f = 0.6 \Omega$ . It is fed from single phase fully controlled rectifier with ac voltage of 250V, 50Hz. Determine (i) motor speed at half of rated motor torque when  $\alpha = 150^\circ$ .

Sol Given data,

1- $\phi$  full converter fed dc series motor

$$V_o = \frac{2V_m \cos \alpha}{\pi}$$

$$= \frac{2\sqrt{2} \times 250 \cos(150^\circ)}{\pi}$$

$$V_o = -194.924 \text{ V}$$

Half rated motor torque,  $\Rightarrow I_a = \frac{T_a}{2} = \frac{10}{2} = 5 \text{ A}$

$$T = K_a f \cdot I_a^2$$

$$I_a = \frac{V_o - K_{res} \cdot N}{K_a f N + R_a + R_f}$$

$$\text{Speed, } N = \frac{V_o - I_a(R_a + R_f)}{K_a f \cdot I_a + K_{res}}$$



Three Phase fully Controlled Converter connected to separately excited DC motor:

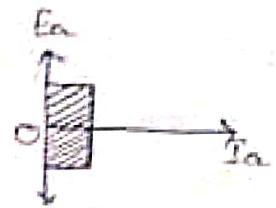
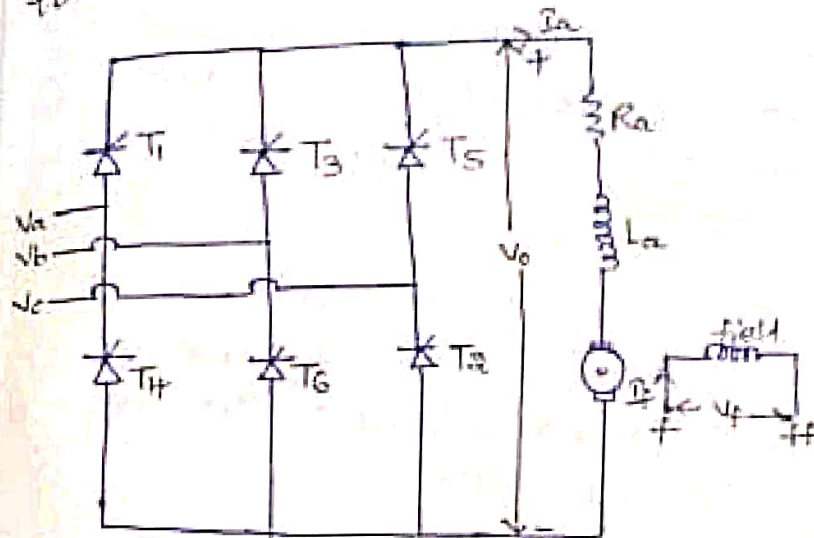
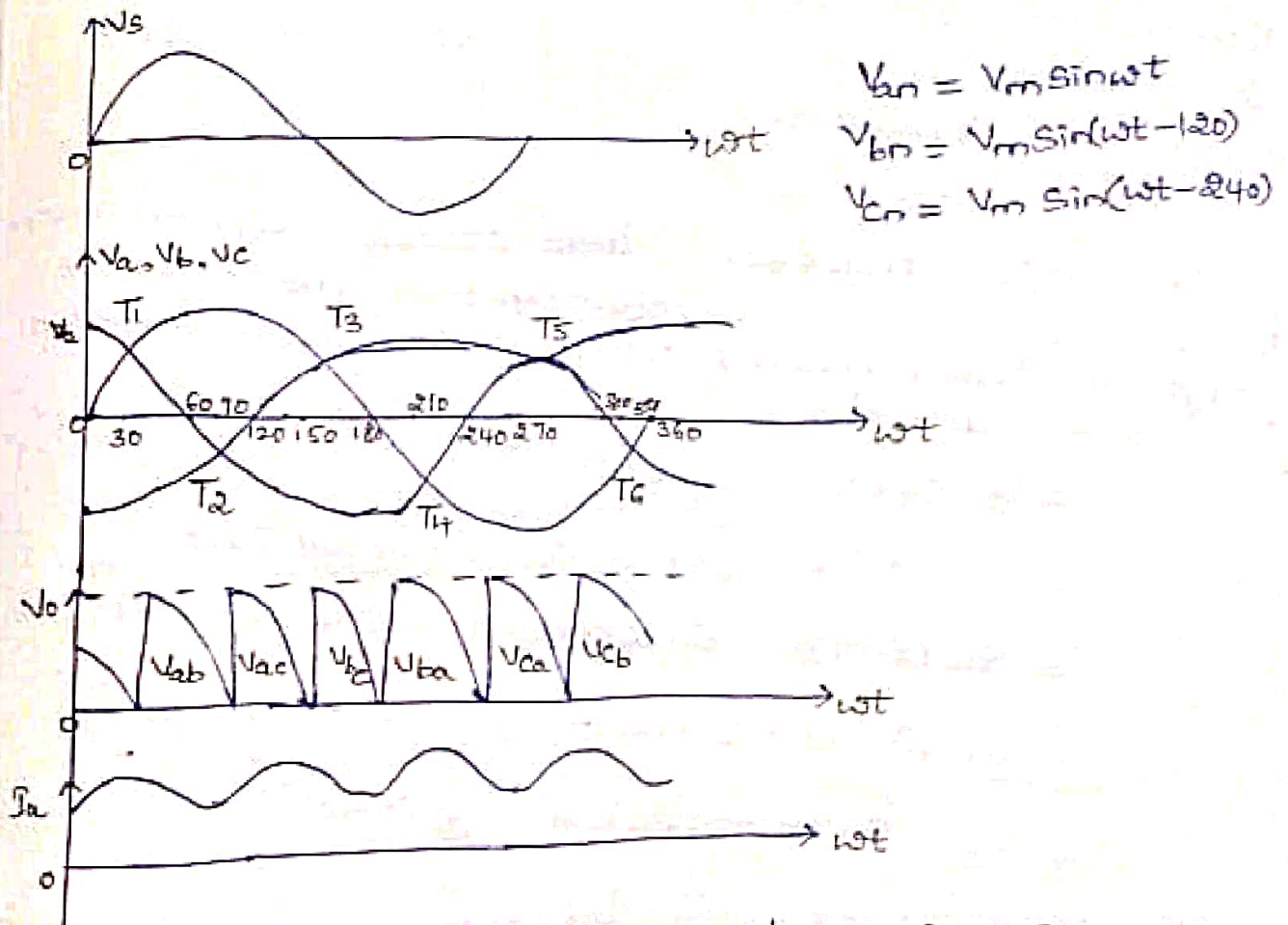

Fig. Quadrant operation

Fig. circuit diagram of 3- $\phi$  full Converter fed separately excited DC motor.



$$V_{a_n} = V_m \sin \omega t$$

$$V_{b_n} = V_m \sin(\omega t - 120)$$

$$V_{c_n} = V_m \sin(\omega t - 240)$$

Fig. wave forms of three Phase full Converter fed separately excited DC motor:

It is a two quadrant converter.

Total number of thyristors in this converter are six.

Thyristors are divided into two groups. Positive group of thyristors are  $T_1, T_3$  and  $T_5$ .

Negative group of thyristors are  $T_5, T_4$  and  $T_3$ .

Thyristors are triggered in sequence according to their numbering.

Each thyristor is triggered at an angle of  $60^\circ$ . Period of conduction of each thyristor is  $120^\circ$ .

Already  $T_6$  is in conduction state.  $T_1$  is triggered at an angle  $\alpha + 30^\circ$ ,  $T_1$  and  $T_6$  are in conduction. Current starts flowing and voltage will appear across load.

$$V_o = V_{ab}$$

$T_2$  is triggered at angle  $\alpha + 90^\circ$ , then  $T_6$  comes to off state due to natural commutation.  $T_3$  is triggered at  $\alpha + 150^\circ$ .  $T_2, T_3$  are in conduction.

$$V_o = V_{ac}$$

In this manner thyristors are triggered based on their numbering. For one cycle of input six pulses obtained. It is a six pulse converter.

$$\therefore V_{ab} = V_{an} - V_{bn}$$

$$= V_m \sin \omega t - V_m \sin(\omega t - 120^\circ)$$

$$= V_m [\sin \omega t - (\sin \omega t \cdot \cos 120^\circ + \cos \omega t \cdot \sin 120^\circ)]$$

$$= V_m [\sin \omega t - \sin \omega t \cdot \cos(90^\circ + 30^\circ) + \cos \omega t \cdot \sin(90^\circ + 30^\circ)]$$

$$= V_m [\sin \omega t - [\sin \omega t (-\sin 30^\circ) + \cos \omega t \cdot \sin 30^\circ]]$$

$$= V_m [\sin \omega t + \frac{1}{2} \sin \omega t + \frac{1}{2} \cos \omega t]$$

$$= V_m \left[ \frac{3}{2} \sin \omega t + \frac{1}{2} \cos \omega t \right]$$

$$= \sqrt{3} V_m \left[ \frac{\sqrt{3}}{2} \sin \omega t + \frac{1}{2} \cos \omega t \right]$$

$$V_{ab} = \sqrt{3} V_m [\sin(\omega t + 30^\circ)]$$

$$\text{output voltage, } V_o = \frac{1}{\pi} \int_{\alpha+30}^{\alpha+90} \sqrt{3} V_m \sin(\omega t + 30^\circ) \cdot d\omega t$$



$$V_o = \frac{3\sqrt{3}V_m}{\pi} [-\cos(\omega t + 30^\circ)]^{k170}$$

$$= \frac{3\sqrt{3}V_m}{\pi} [-\cos(\omega t + 60^\circ) + \cos(\omega t + 120^\circ)]$$

$$= \frac{3\sqrt{3}V_m}{\pi} [-\cos(\omega t + 120^\circ) + \cos(\omega t + 60^\circ)]$$

$$= \frac{3\sqrt{3}V_m}{\pi} [-\cos(180 + (\omega - 60^\circ)) + \cos(\omega t + 60^\circ)]$$

$$= \frac{3\sqrt{3}V_m}{\pi} [\cos(\omega - 60^\circ) + \cos(\omega t + 60^\circ)]$$

$$= \frac{3\sqrt{3}V_m}{\pi} (\cos \alpha \cdot \cos 60^\circ)$$

$$= \frac{3\sqrt{3}V_m}{\pi} \cdot \frac{1}{2} \cos \alpha \cdot \frac{1}{2}$$

$$V_o = \frac{3\sqrt{3}V_m}{\pi} \cos \alpha$$

where  $V_m = \sqrt{2} V_s$  and  $V_s = \frac{V_L}{\sqrt{2}}$

Torque-speed characteristics:

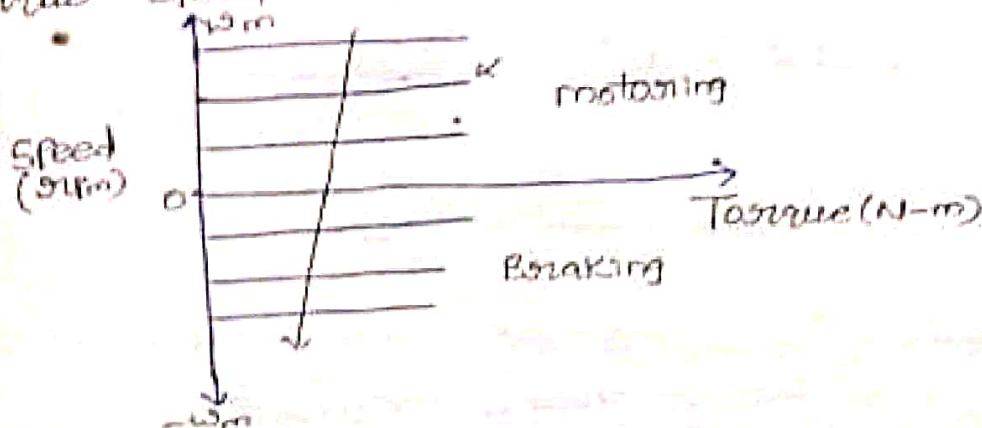

Back emf,  $E_b = V_o - I_a R_a$

$$E_b = K_m \cdot \omega_m$$

$$\omega = K_a \phi I_a$$

$$N = \frac{V_o - I_a R_a}{K_a \phi}$$

Three phase fully controlled converter connected to DC series motor:

It is a two quadrant converter. Circuit diagram, quadrant operation and waveforms are shown below.

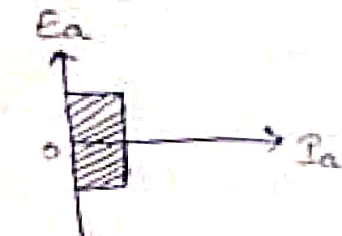
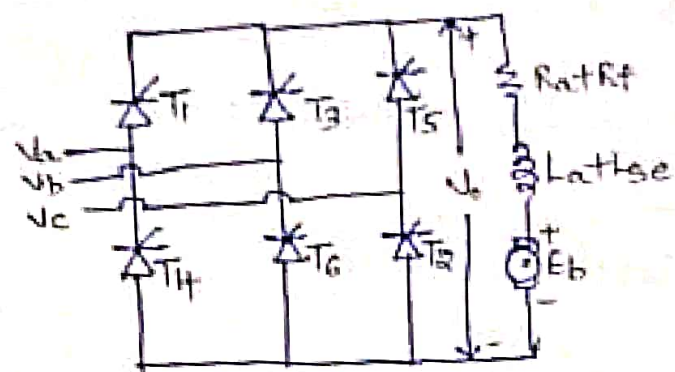

Fig. Quadrant operation

Fig. Circuit diagram for three phase fully controlled converter fed DC series motor.

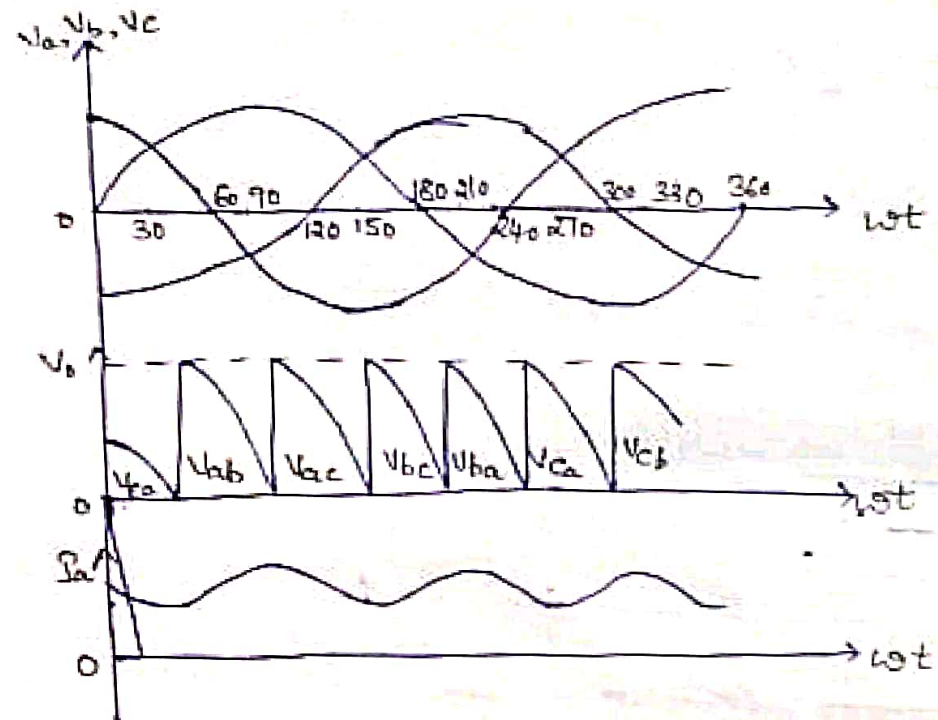

Fig. waveforms.

It is a two quadrant converter.

Total number of thyristors are six. Thyristors are divided into two groups i.e., positive and negative group of thyristors. Positive group of thyristors are T1, T3 and T5. Negative group of thyristors are T2, T4 and T6.

Thyristors are triggered in sequence based upon their numbering.



Each thyristor is triggered at an angle of  $60^\circ$ .  
Period of conduction of each thyristor is  $120^\circ$ .

Already  $T_6$  is in conduction state.  $T_1$  is triggered at an angle of  $\alpha + 30$ .  $T_1$  and  $T_6$  are in conduction, voltage will appear across load.

$$V_o = V_{ab}$$

In this manner thyristors are triggered in sequence according to their numbering.

Note: Output voltage derivation is as same as three phase fully controlled converter fed separately excited DC motor.

$$V_o = \frac{3\sqrt{3}V_m}{2\pi} \cos\alpha$$

where  $V_m = \sqrt{2}V_s$  and  $V_s = \frac{V_L}{\sqrt{3}}$

Torque - speed characteristics:

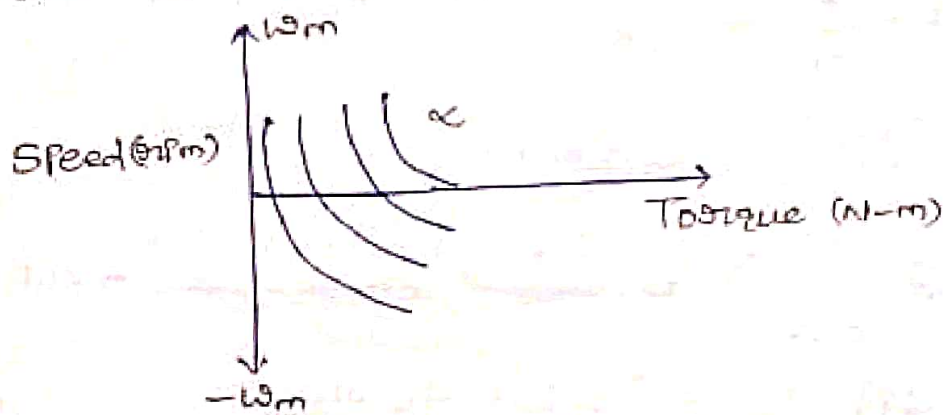

Back emf,  $E_b = V_o - I_a(R_a + R_f)$

$$E_b = K_{af} \cdot I_a \cdot N + K_{res} \cdot N$$

$$T = K_{af} \cdot I_a^2$$

$$N = \frac{V_o - I_a(R_a + R_f)}{K_{af} \cdot I_a + K_{res}}$$

$$T = K_{af} \left[ \frac{V_o - K_{res} \cdot N}{K_{af} \cdot N + R_a + R_f} \right]^2$$

where  $I_a = \frac{V_o - K_{res} \cdot N}{K_{af} \cdot N + R_a + R_f}$

Problems:

1. The speed of separately excited dc motor is controlled by a three phase fully controlled rectifier. Calculate speed of motor at a torque of 50 N-m for firing angle of  $45^\circ$ .  
3- $\phi$ , 415V, 50Hz,  $k_m = 1.5$  Vs/rad,  $R_a = 0.9\Omega$

Sol Given data,

3- $\phi$  fully controlled fed separately excited dc motor.

$$V_o = \frac{3\sqrt{3}V_m}{\pi} \cos \alpha$$

$$V_m = \sqrt{2} V_s \Rightarrow V_s = \frac{V_L}{\sqrt{3}} = \frac{415}{\sqrt{3}} = 239.6 \text{ V}$$

$$V_m = \sqrt{2} \times 239.6 = 338.845 \text{ V}$$

$$T = k_m \cdot I_a$$

$$I_a = \frac{T}{k_m} = \frac{50}{1.5} = 33.33 \text{ A}$$

$$V_o = \frac{3\sqrt{3} \times 338.845}{\pi} \cos 45^\circ = 396.294 \text{ V}$$

$$N = \frac{V_o - I_a R_a}{k_a \phi} = \frac{396.294 - 33.33 \times 0.9}{1.5} = 244.19 \text{ rad/sec}$$

$$N = 244.19 \times \frac{60}{2\pi} = 2331.84 \text{ rpm}$$

2. A 220V, 1500rpm, 50A separately excited dc motor is fed from three phase fully controlled rectifier with ac source voltage of 440V, 50Hz. Determine firing angle when motor running at -800rpm twice the stated torque.  $R_a = 0.5\Omega$

Sol Given that,

3- $\phi$  fully controlled rectifier fed separately excited dc motor.

$$V_L = 440 \text{ V}$$

$$N_1 = 1500 \text{ rpm}$$

$$N_2 = -800 \text{ rpm}$$



$$I_a = 50 \text{ A}$$

$$R_a = 0.5 \Omega$$

$$V_o = \frac{3\sqrt{3} V_m}{\pi} \cos \alpha \rightarrow \textcircled{1}$$

$$V_m = \sqrt{2} V_L$$

$$V_g = \frac{V_L}{\sqrt{2}} = \frac{1140}{\sqrt{2}} = 254.034 \text{ V}$$

$$V_m = \sqrt{2} \times 254.034 = 359.25 \text{ V}$$

$$\frac{E_{b1}}{E_{b2}} = \frac{N_1}{N_2}$$

$$E_{b1} = V_o - I_a R_a = 220 - 50 \times 0.5 = 195 \text{ V}$$

$$E_{b2} = V_o - I_a R_a = 1140 - 50 \times 0.5 = 1150 \text{ V}$$

$$\frac{E_{b1}}{E_{b2}} = \frac{N_1}{N_2} \Rightarrow E_{b2} = \frac{E_{b1} \cdot N_2}{N_1} = \frac{195 \times 200}{1500} = -104 \text{ V}$$

$$V_o = E_{b2} + I_a R_a = -104 + 50 \times 0.5 = -54 \text{ V}$$

$$\textcircled{1} \Rightarrow -54 = \frac{3\sqrt{3} \times 359.25}{\pi} \cos \alpha$$

$$-54 = 594.19 \cos \alpha$$

$$\cos \alpha = \frac{-54}{594.19} = 95.21^\circ$$

Note:

1.  $\alpha > 90 \rightarrow$  Speed is Negative

2.  $\alpha < 90 \rightarrow$  Speed is Positive

3. A 80 kW, 440V, 800 rpm separately excited DC motor is operating at 600 rpm and developing 75% of rated torque controlled by 3- $\phi$  six pulse converter. If back emf at rated speed is 410V, Determine firing angle of armature converter. Input is 3- $\phi$ , 450V, 50Hz supply.

Sol Given that,

3- $\phi$  Six Pulse Converter fed separately excited DC motor.

$$\text{Power } P = 80 \text{ kW}$$

$$V_L = 450 \text{ V}$$

$$V_0 = 110 \text{ V}$$

$$N_1 = 600 \text{ turns}$$

$$N_2 = 600 \text{ turns}$$

$$P = 3 V_a I_a \Rightarrow I_a = \frac{P}{3 V_a}$$

$$V_a = \frac{V}{\sqrt{3}} = \frac{1150}{\sqrt{3}} = 659.807 \text{ V}$$

$$I_a = \frac{P \times 10^3}{3 \times 659.807} = 102.64 \text{ A}$$

$$\frac{E_{12}}{E_{22}} = \frac{N_1}{N_2} \Rightarrow E_{12} = \frac{E_{22} N_1}{N_2}$$

$$E_{12} = V_0 - I_a R_a \Rightarrow 110 = 102.64 \times R_a = 110$$

$$R_a = \frac{110 - 110}{-102.64} = 0.29 \Omega$$

$$E_{22} = \frac{110 \times 600}{600} = 308.27 \text{ V}$$

$$E_{22} = V_0 - I_a R_a$$

$$307.5 - V_0 = -0.75 \times 102.64 \times 0.29$$

$$-V_0 = -0.75 \times 102.64 \times 0.29 - 308.27$$

$$V_0 = 330.594 \text{ V}$$

$$\frac{3\sqrt{3} V_m}{\pi} \cos \alpha = 330.594 \text{ V}$$

$$\frac{3\sqrt{3} \times \sqrt{2} \times 259.807}{\pi} \cos \alpha = 330.594$$

$$330.594 = 607.71 \cos \alpha$$

$$\alpha = \cos^{-1} \left( \frac{330.594}{607.71} \right)$$

$$\alpha = 57.04^\circ$$



Three Phase (half) Semi Controlled Converter  
 fed Separately Excited DC motor:  
 It is a single quadrant converter.

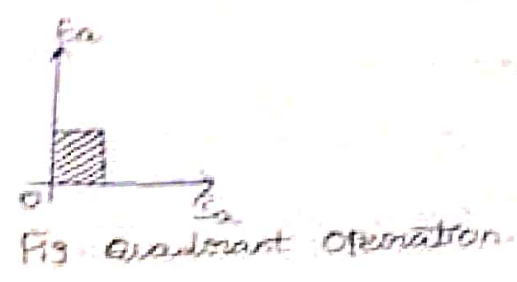
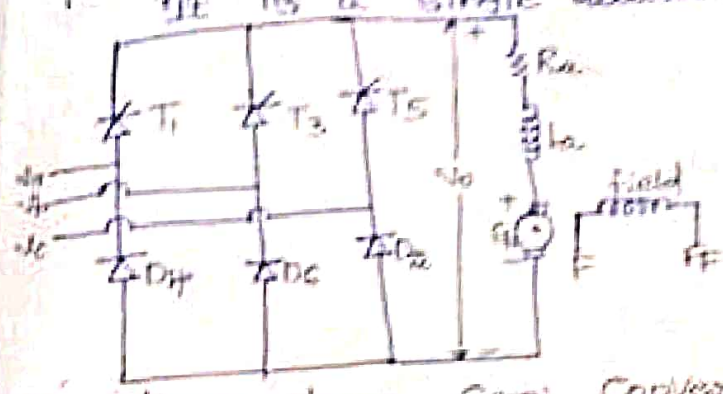

Fig. Three Phase Semi Converter fed Separately  
 Excited DC motor.

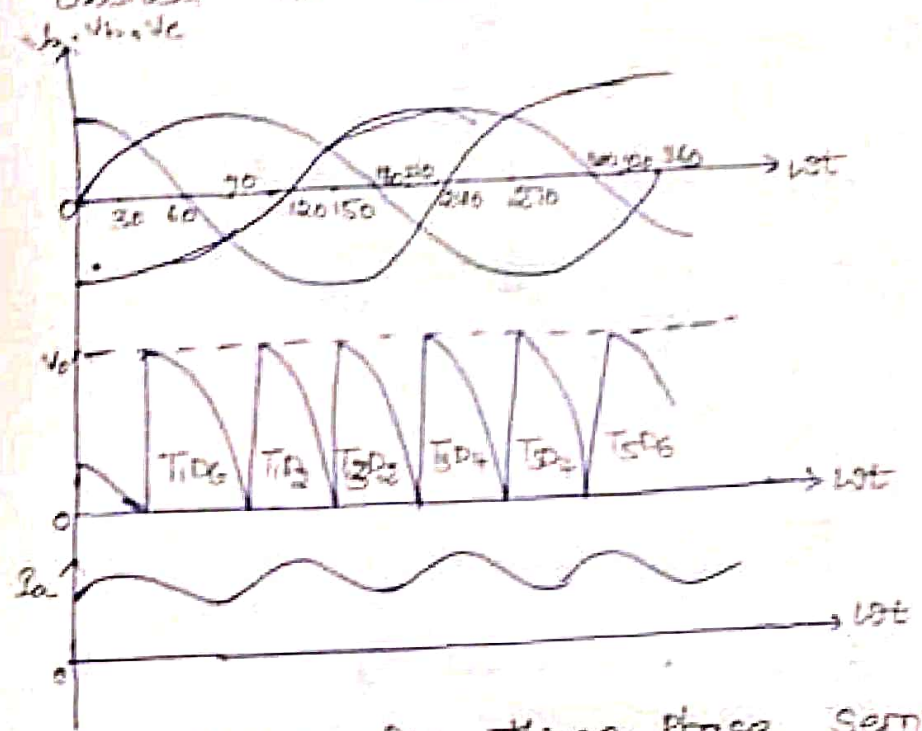

Fig. wave forms for three phase Semi Controlled  
 Converter Connected to Separately excited DC motor.

Total number of thyristors in this converter  
 are three and total number of diodes are  
 three.

Period of conduction of each thyristor is  $120^\circ$ .

Already  $T_6$  is in conduction.  $T_1$  is triggered  
 at angle of  $\alpha + 30^\circ$ ,  $D_6$  starts conducting, current  
 starts flowing through load and voltage will  
 appear across load.

$$V_0 = V_{ab}$$

$D_6$  comes to off state at  $\frac{\pi}{2}$  due to reverse bias.  
 Next  $D_2$  start conducting with  $T_1$ .

$$V_0 = V_{ac}$$

In this manner, thyristors are triggered  
 sequence based upon their numbering.

For one cycle of input, six pulses were  
 obtained. Hence it is a six pulse converter.

Average output voltage,

$$\begin{aligned}
 V_o &= \frac{1}{2\pi} \int_{\alpha+30}^{120-\frac{\pi}{2}} V_{ab} \cdot d\omega t + \int_{60-\frac{\pi}{2}}^{\alpha+150} V_{ac} \cdot d\omega t \\
 &= \frac{3}{2\pi} \int_{\alpha+30}^{120-\frac{\pi}{2}} \sqrt{3} V_m \sin \omega t \cdot d\omega t + \int_{60-\frac{\pi}{2}}^{\alpha+150} \sqrt{3} V_m \sin \omega t \cdot d\omega t \\
 &= \frac{3\sqrt{3} V_m}{2\pi} \int_{\alpha+30}^{\frac{\pi}{2}} \sin \omega t \cdot d\omega t + \int_{\frac{\pi}{2}}^{\alpha+150} \sin \omega t \cdot d\omega t \\
 &= \frac{3\sqrt{3} V_m}{2\pi} \left[ -\cos \omega t \right]_{\alpha+30}^{\frac{\pi}{2}} + \left[ -\cos \omega t \right]_{\frac{\pi}{2}}^{\alpha+150} \\
 &= \frac{3\sqrt{3} V_m}{2\pi} \left[ 0 + \cos(\alpha+30) + -\cos(\alpha+150) - 0 \right] \\
 &= \frac{3\sqrt{3} V_m}{2\pi} \left[ \cos(\alpha+30) + -\cos(\alpha+150) \right]
 \end{aligned}$$

$$V_o = \frac{3\sqrt{3} V_m}{2\pi} (1 + \cos \alpha)$$

where  $V_m = \sqrt{2} V_s$

$$V_s = \frac{V_L}{\sqrt{3}}$$

Torque - Speed characteristics:

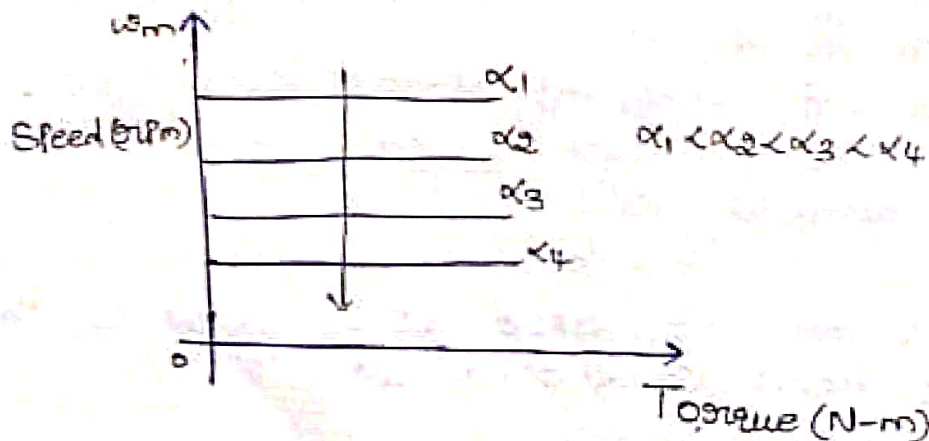



For Separately Excited dc motor,

$$E_b = V_o - I_a R_a$$

$$\Phi_f = K_m \omega_m$$

$$T = K_a \Phi I_a$$

$$I_a = \frac{T}{K_a \Phi}$$

$$\text{Speed } N = \frac{V_o - I_a R_a}{K_a \Phi}$$

Three phase Semi Controlled Converter Connected to Series Dc motor:

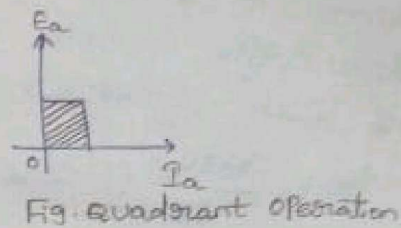
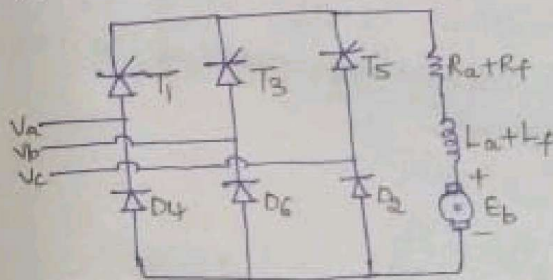

Fig. Quadrant operation

Fig. 3- $\phi$  Semi Converter Connected to DC Series motor

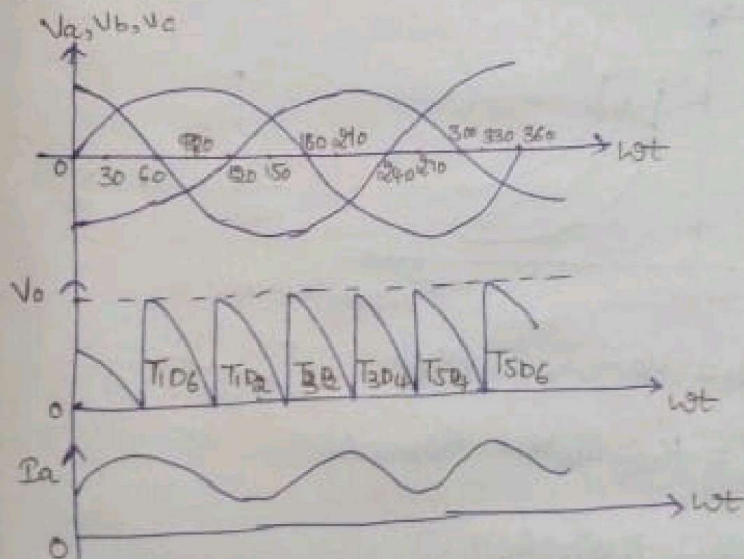

Fig. waveforms of 3- $\phi$  semi converter fed DC series motor

It is a single quadrant converter.

Total number of thyristors in this converter are three and total number of diodes are three. Period of conduction is  $120^\circ$

Thyristors are triggered in sequence based upon their numbering.

Already  $T_6$  is in conduction  $T_1$  is triggered at  $\omega t = 30^\circ$ ,  $T_1$  and  $D_6$  are in conduction.

$$V_o = V_{a1}$$

Due to reverse bias  $D_6$  comes to off state at  $\omega t = 120^\circ$ .  
Next  $D_2$  starts conducting with  $T_1$ .

$$V_o = V_{a2}$$

In this manner thyristors are triggered in sequence based upon their numbering.

For one cycle of input, six pulses obtained. Hence it is a six pulse converter.

Note: output voltage derivation is as same as 3- $\phi$  semi converter fed separately excited dc motor.

$$\therefore V_o = \frac{3\sqrt{3}V_m}{2\pi} (1 + \cos\alpha)$$

$$V_m = \sqrt{2}V_s \quad \text{and} \quad V_s = \frac{V_L}{\sqrt{3}}$$

Torque-speed characteristics:

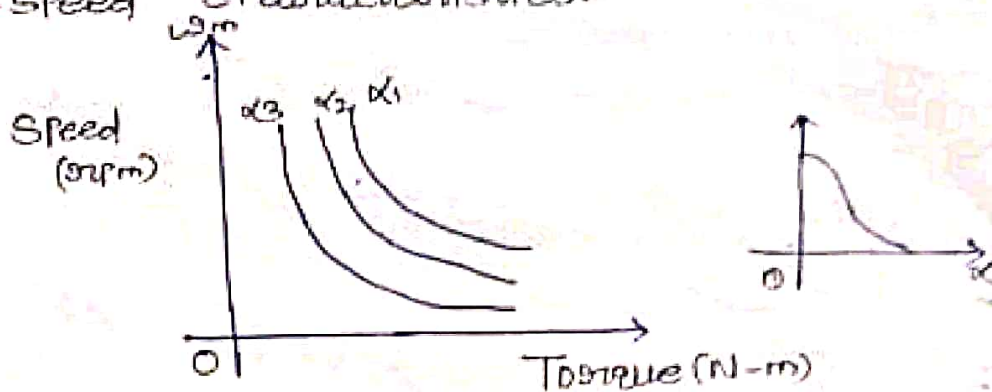

Back emf,  $E_b = V_o - I_a(R_a + R_f)$

$$\gamma = K_{at} I_a N + K_{res} \cdot N$$

$$N = \frac{V_o - I_a(R_a + R_f)}{K_{at} \frac{I_a}{a} + R_a + R_f + K_{res}}$$



Sl. No.	Type of motor	output voltage, back emf	Torque and speed
1	1- $\phi$ Semi Converter fed Separately excited Dc motor	$V_o = \frac{V_m}{\pi} (1 + \cos \alpha)$ $E_b = V_o - I_a R_a$ $E_b = K_a \phi N$	$T = K_a \phi I_a$ $N = \frac{V_o - I_a R_a}{K_a \phi}$
2	1- $\phi$ Semi Converter fed Dc Series motor	$V_o = \frac{V_m}{\pi} (1 + \cos \alpha)$ $E_b = V_o - I_a (R_a + R_f)$ $E_b = K_a \phi I_a N + K_{res} N$	$T = K_a \phi I_a$ $T = K_a \phi I_a^2$ $N = \frac{V_o - I_a (R_a + R_f)}{K_a \phi I_a + K_{res}}$
3	1- $\phi$ fully Converter fed Separately excited Dc motor	$V_o = \frac{2V_m}{\pi} \cos \alpha$ $E_b = V_o - I_a R_a$ $E_b = K_m \omega_m$	$T = K_a \phi I_a$ $N = \frac{V_o - I_a R_a}{K_a \phi}$
4	1- $\phi$ fully Converter fed Dc Series motor	$V_o = \frac{2V_m}{\pi} \cos \alpha$ $E_b = V_o - I_a (R_a + R_f)$ $E_b = K_a \phi I_a N + K_{res} N$	$T = K_a \phi I_a$ $T = K_a \phi I_a^2$ $N = \frac{V_o - I_a (R_a + R_f)}{K_a \phi I_a + K_{res}}$
5	3- $\phi$ Semi Converter fed Separately excited motor	$V_o = \frac{3\sqrt{3}V_m}{2\pi} (1 + \cos \alpha)$ $T = K_a \phi I_a$ $E_b = V_o - I_a R_a; V_s = \frac{V_L}{\sqrt{3}}$	$T = K_a \phi I_a$ $N = \frac{V_o - I_a R_a}{K_a \phi}$
6	3- $\phi$ fully Converter fed Separately excited Dc motor	$V_o = \frac{3\sqrt{3}V_m}{\pi} \cos \alpha$ $T = K_a \phi I_a$ $E_b = V_o - I_a R_a$	$N = \frac{V_o - I_a R_a}{K_a \phi}$
7	3- $\phi$ Semi Converter fed Dc Series motor	$V_o = \frac{3\sqrt{3}V_m}{2\pi} (1 + \cos \alpha)$ $E_b = K_a \phi I_a N + K_{res} N$ $E_b = V_o - I_a (R_a + R_f)$	$T = K_a \phi I_a^2$ $N = \frac{V_o - I_a (R_a + R_f)}{K_a \phi I_a + K_{res}}$
8	3- $\phi$ full Converter fed Dc Series motor	$V_o = \frac{3\sqrt{3}V_m}{\pi} \cos \alpha$ $E_b = V_o - I_a (R_a + R_f)$ $E_b = K_a \phi I_a N + K_{res} N$	$N = \frac{V_o - I_a (R_a + R_f)}{K_a \phi I_a + K_{res}}$

## Notes:

Parameter	Unit
Back emf ( $E_b$ )	Volts
Torque ( $T$ )	N-m
$K_m$	Volt sec/rad
Speed ( $N$ )	rpm $= \frac{2\pi}{60}$ rad/sec

\* If  $K_m$  value is not given in problem, it has to be neglected.

\* Two speeds were given and to calculate back emf

$$\frac{E_{b1}}{E_{b2}} = \frac{N_1}{N_2}$$

1. By using Armature control method, speed below rated speed was obtained.
2. By field control method, speeds above rated speed was obtained.