

- x2 x2 x1 x4 x1 x1 x1 x5 x2 x1 x1 x1 x9 x20 x1 x1 x15
- x2 x4 x2 x15 x7 x23 x28 x16 x7 x1
- x1 x40 x2 x2 x4 x3 x11 x5 x14 x4

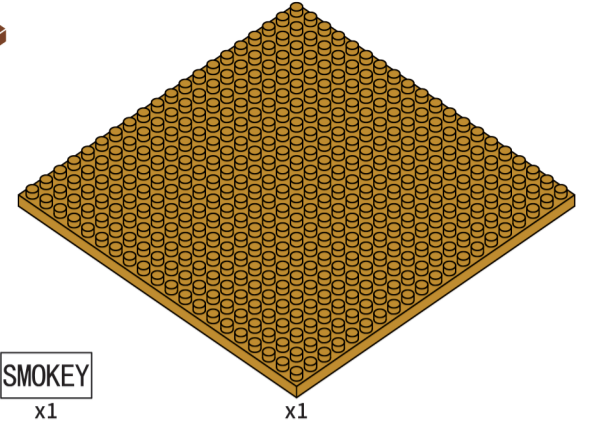

1

2

3

4

5

6

7

8

9

10

11

12

13

14

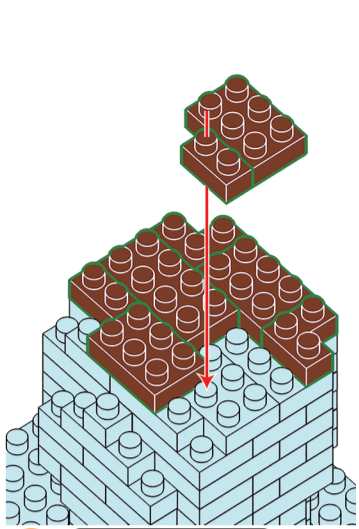
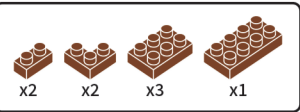

15

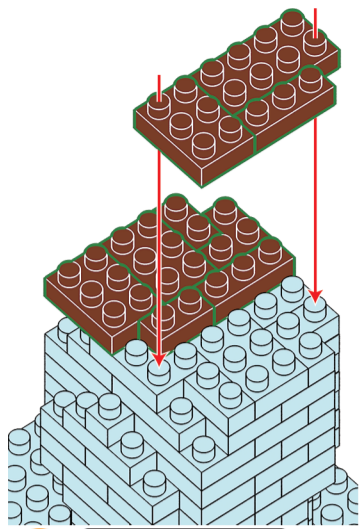
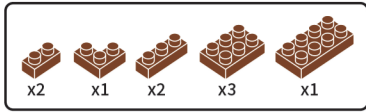

16

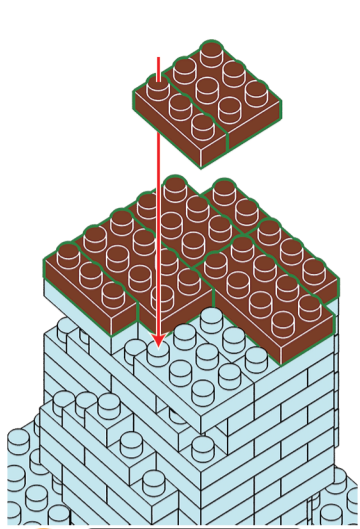
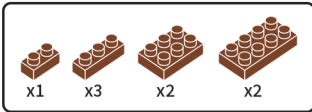

17

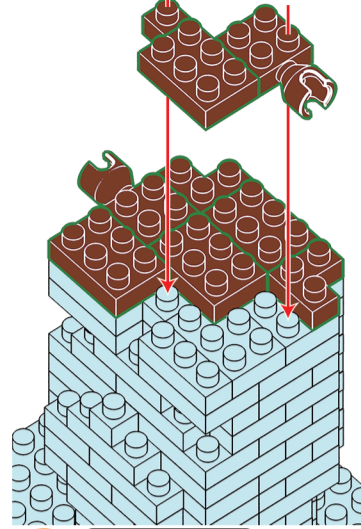
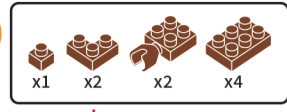

18

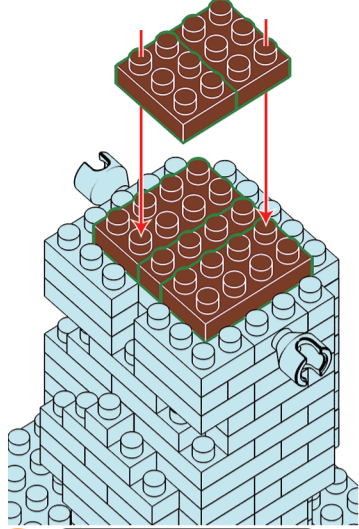
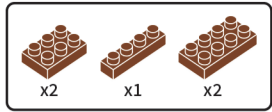

19

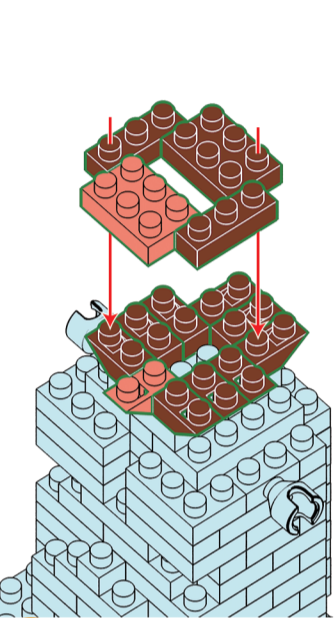
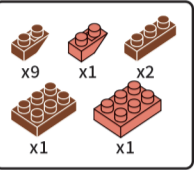

20

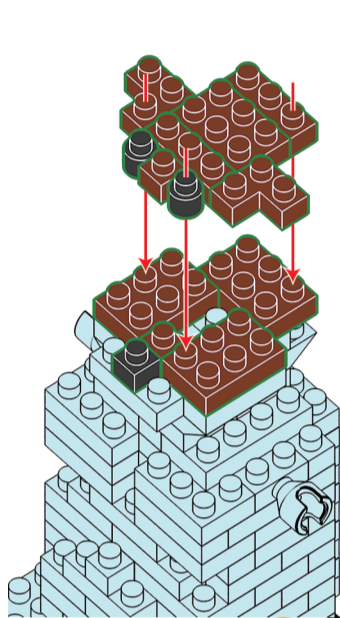
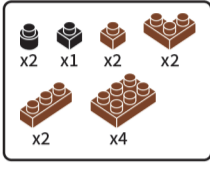

21

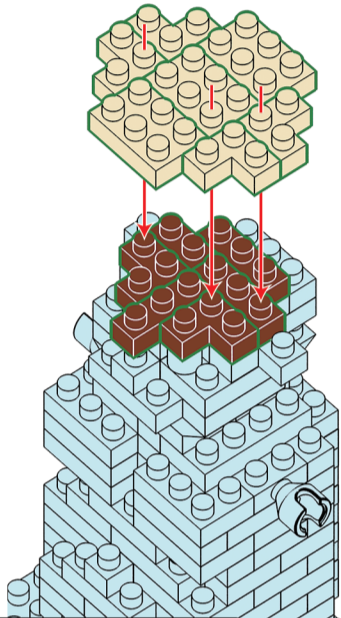
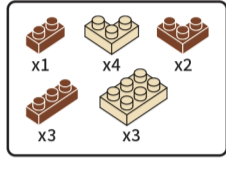

22

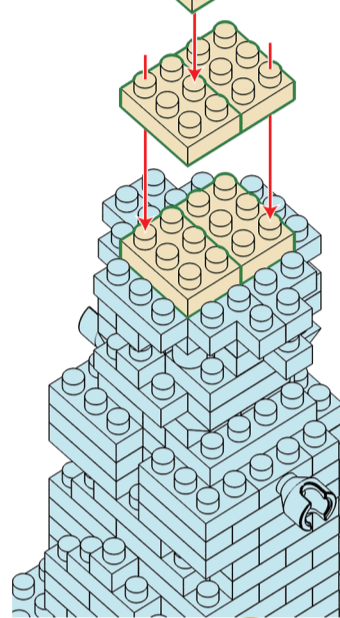
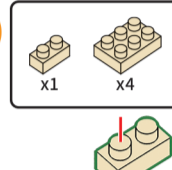

23

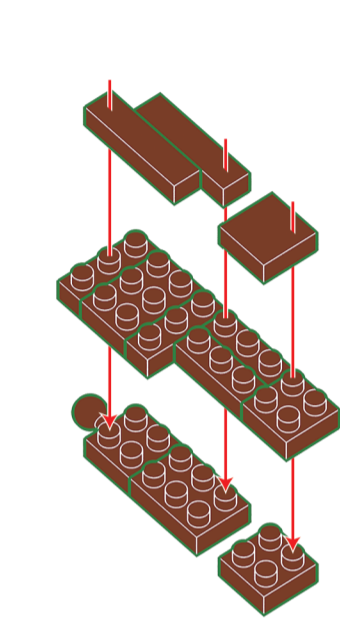
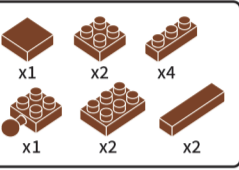

24

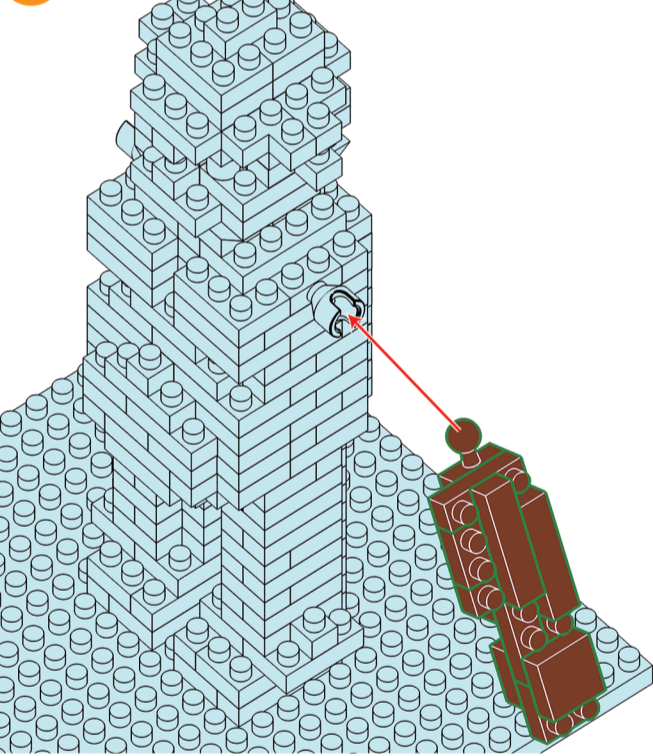

25

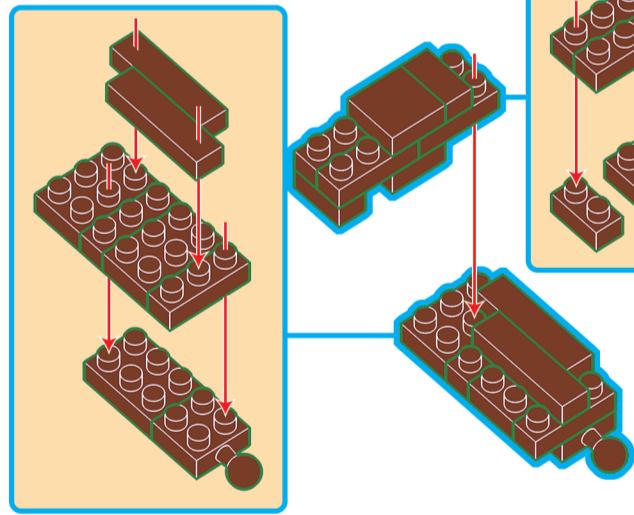
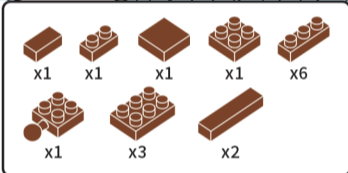

26

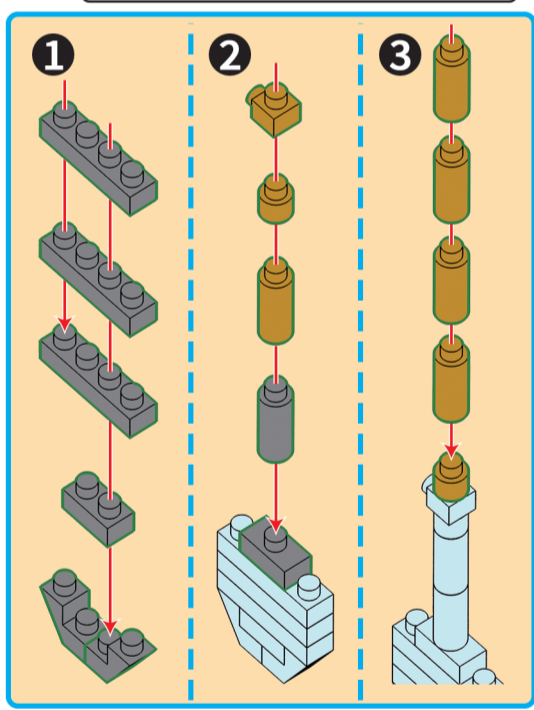
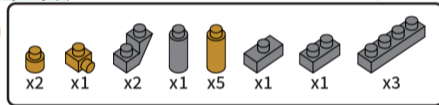

27

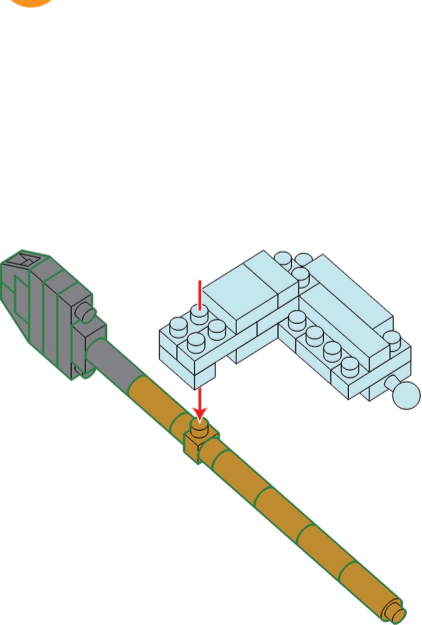

28

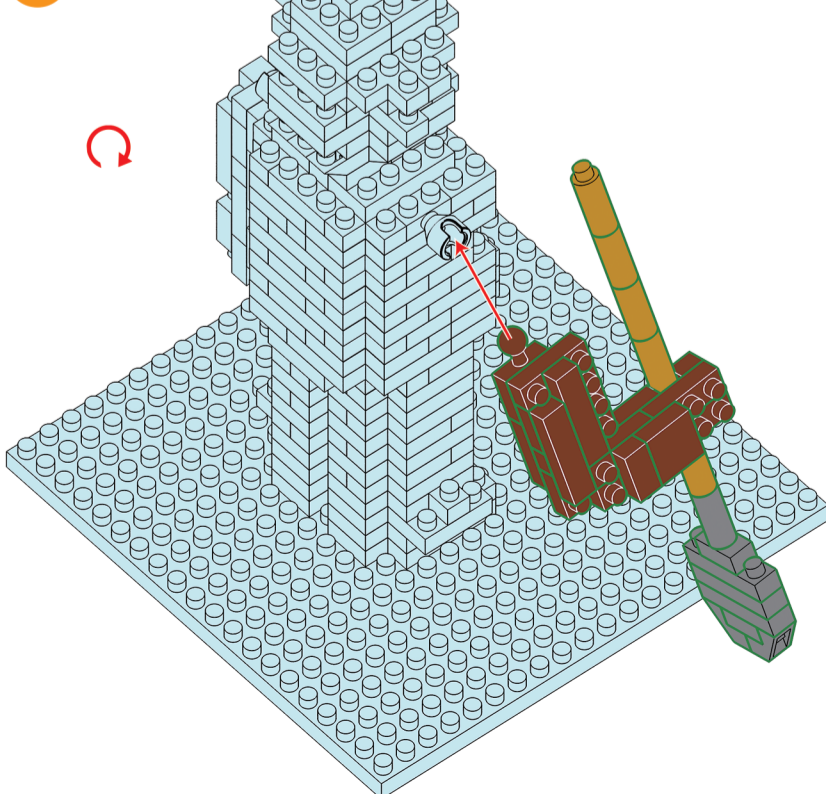

29

