

- X2
- X6
- X4
- X4
- X6
- X1
- X9
- X2
- X12
- X2
- X4
- X14
- X3
- X11
- X2
- X8
- X1
- X1
- X8
- X6
- X2
- X14
- X6
- X2
- X3
- X8
- X1
- X11
- X2
- X18
- X2
- X1
- X24
- X1

- X1
- X2
- X1
- X3

1

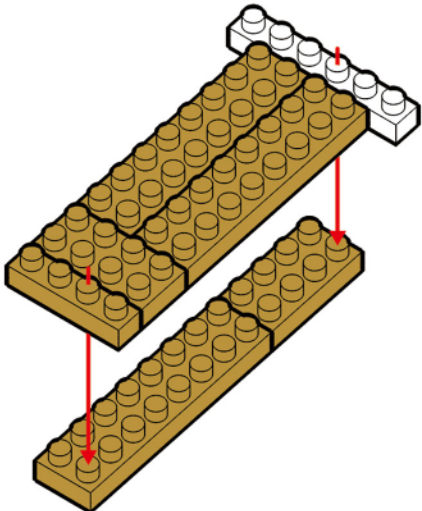

- X1
- X6
- X2
- X2
- X1
- X2
- X4

2

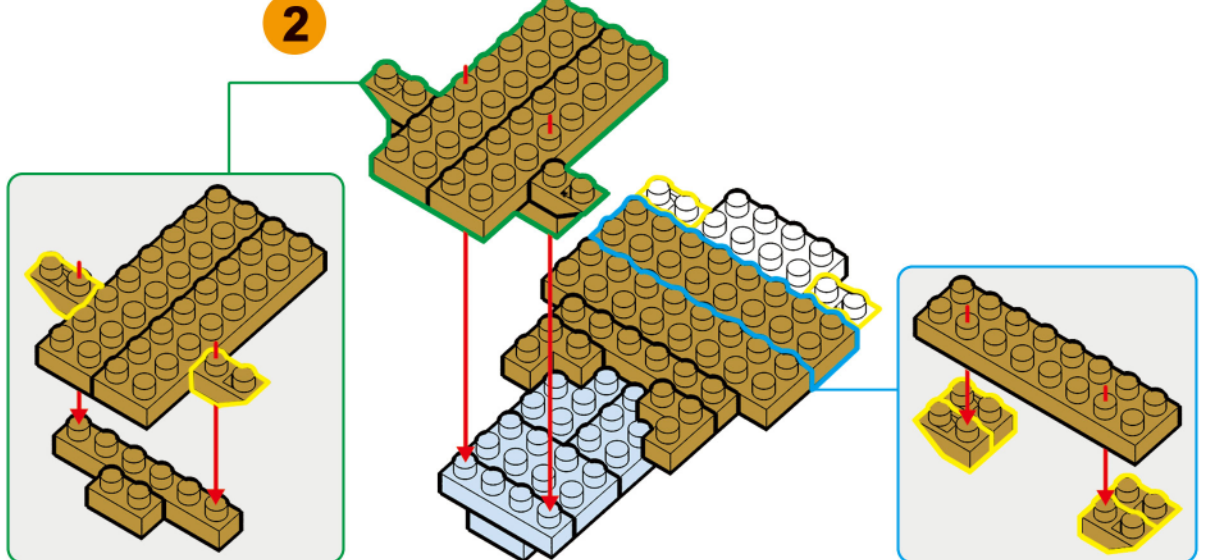

- X2
- X2
- X1
- X1
- X1
- X2
- X1
- X4

3

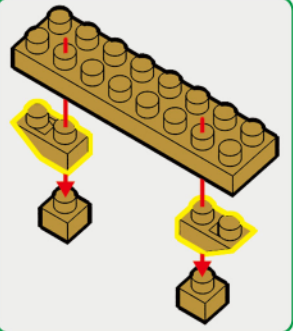
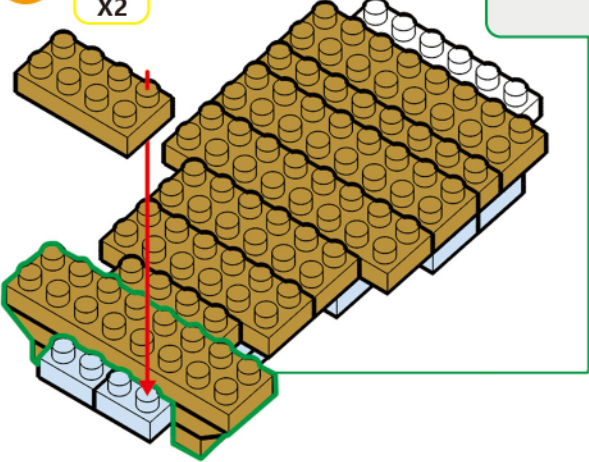

- X2
- X2
- X1
- X1
- X2
- X2

4

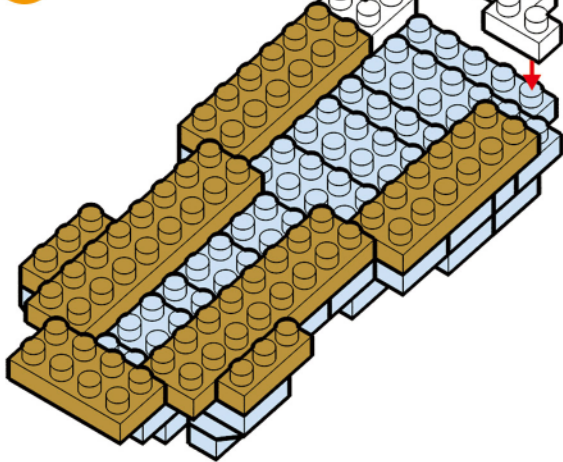

- X2
- X2
- X2
- X1
- X4

5

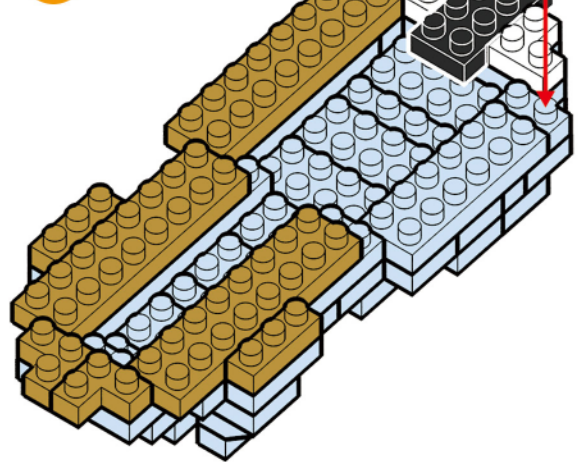

- X2
- X2
- X1
- X1
- X2
- X4
- X2

6

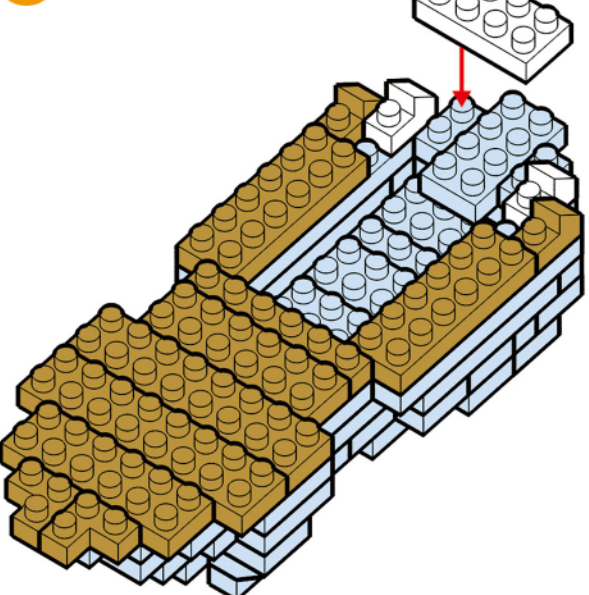

- X2
- X2
- X4
- X1
- X1
- X2
- X5
- X2
- X2

7

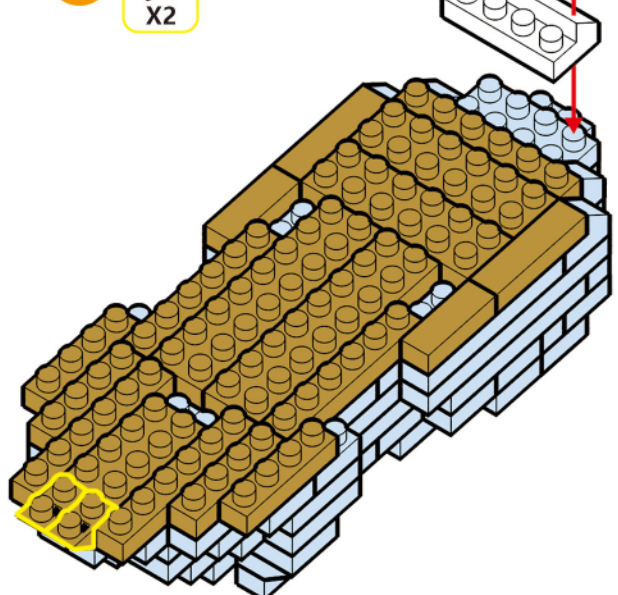

- X2
- X2
- X2
- X1
- X2
- X4
- X2

8

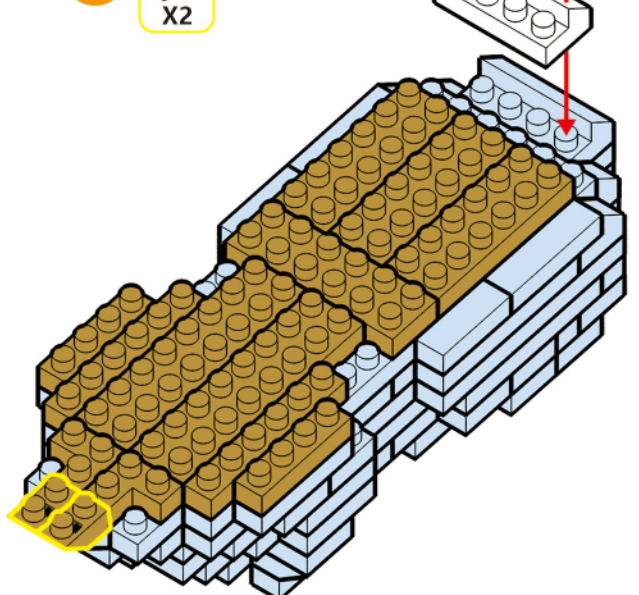

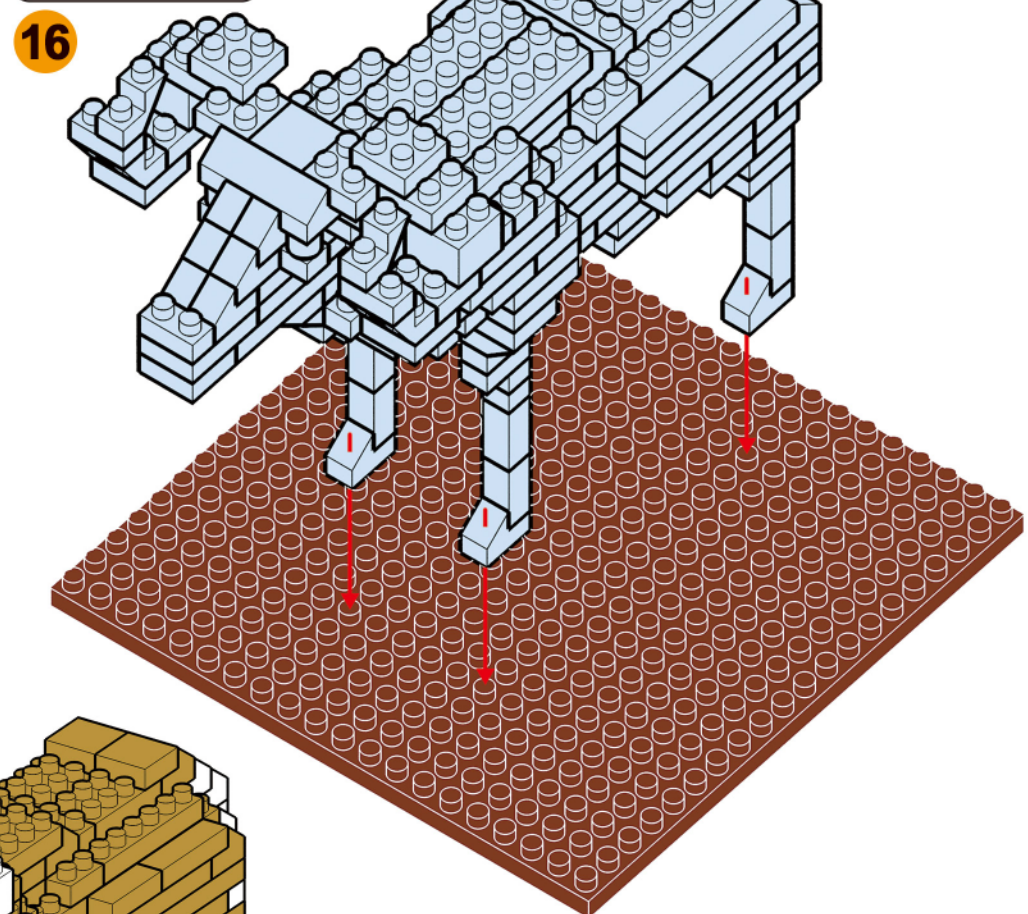
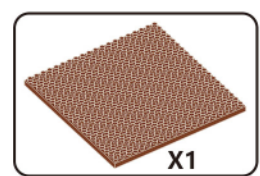
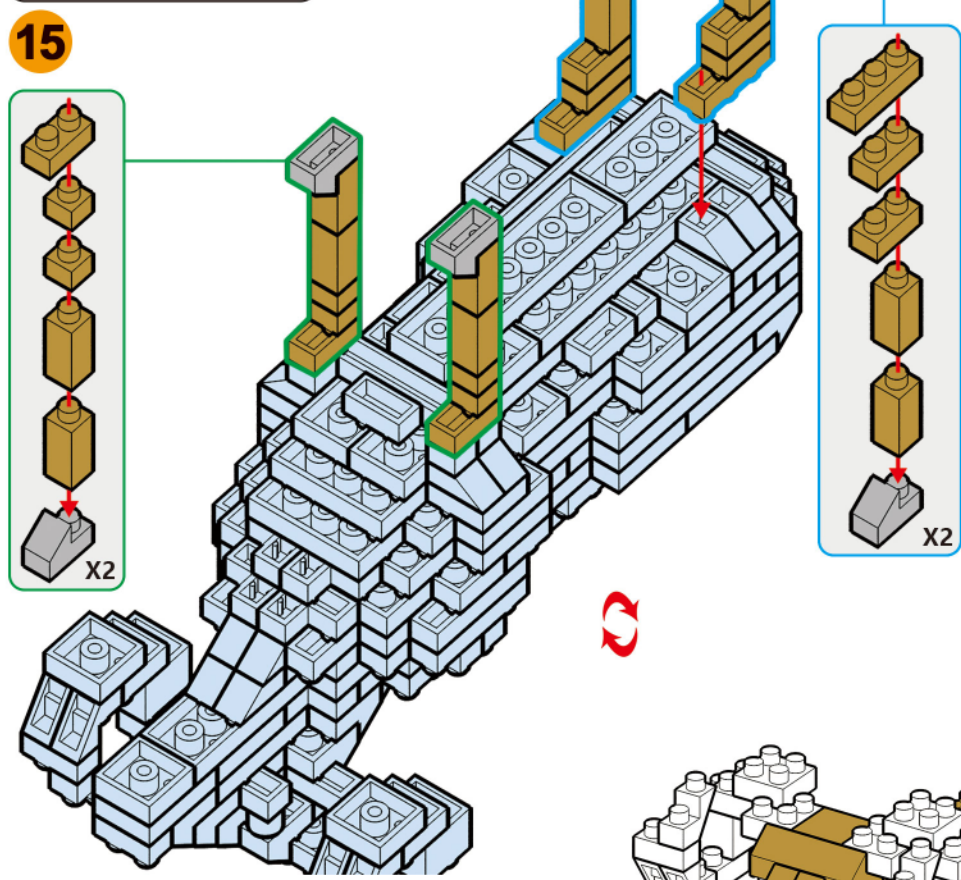
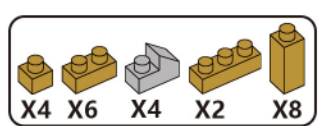
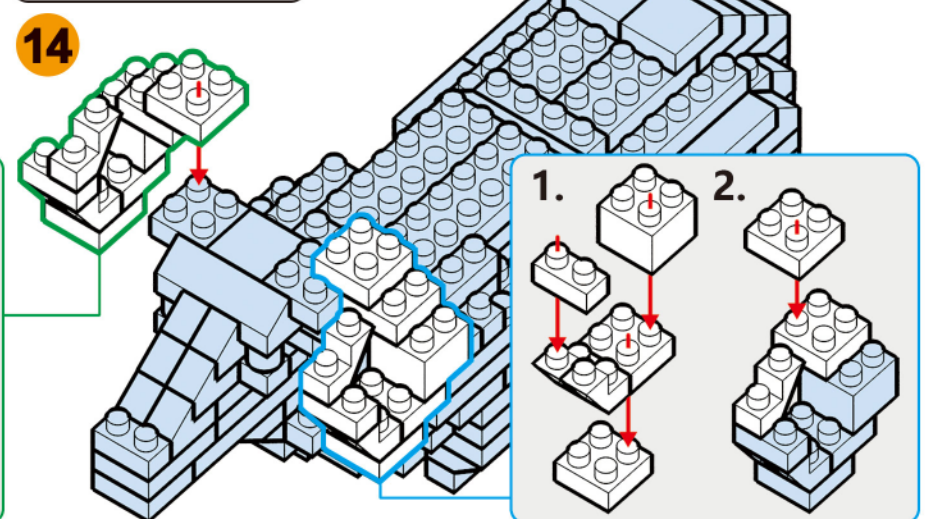
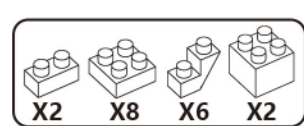
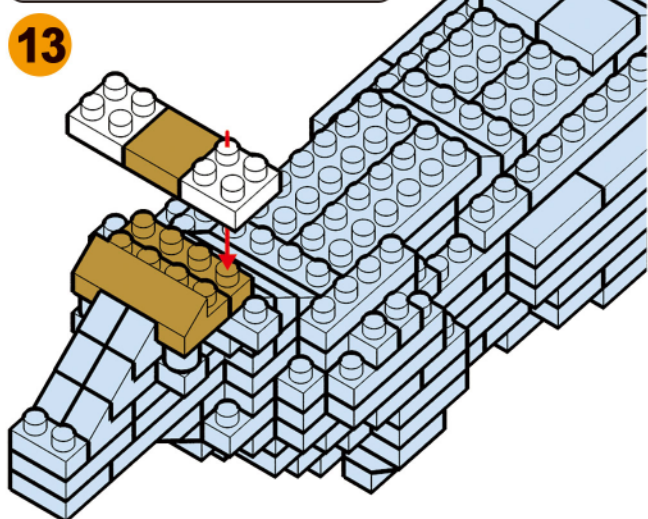
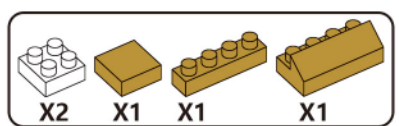
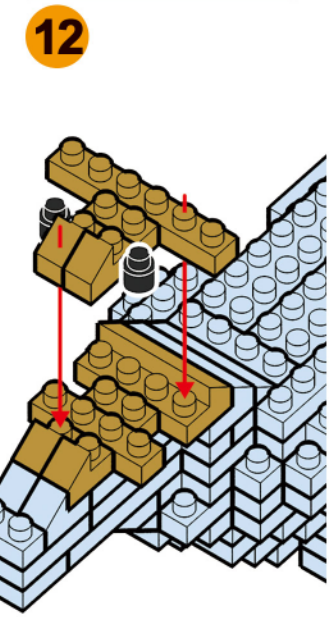
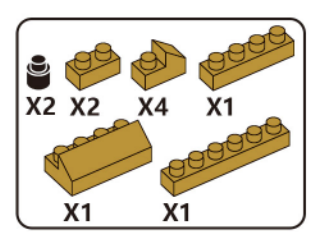
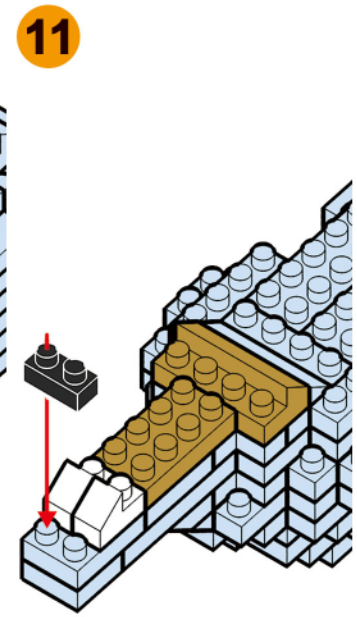
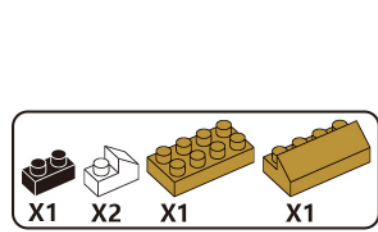
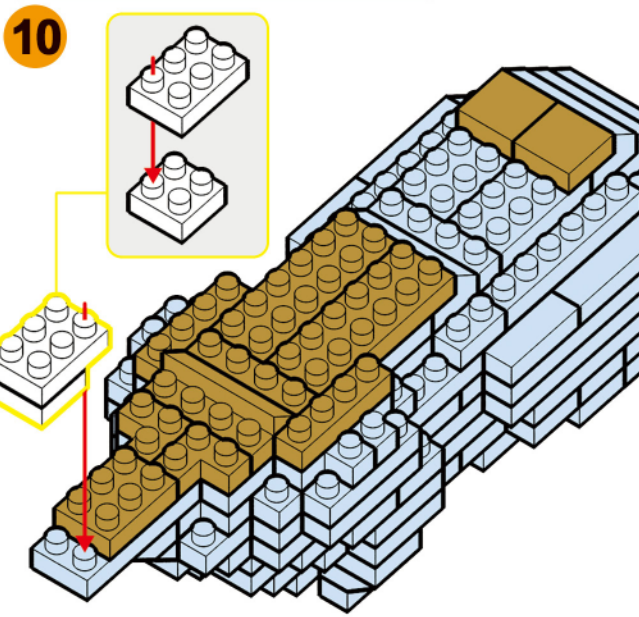
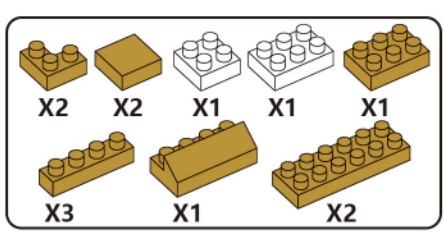
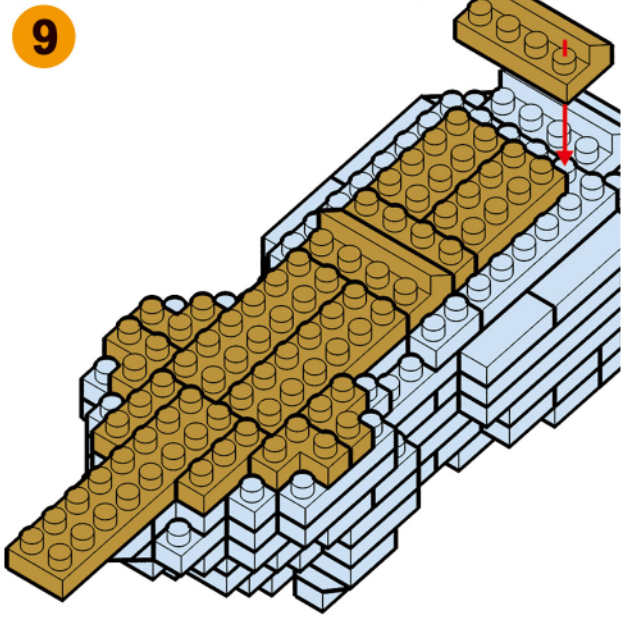
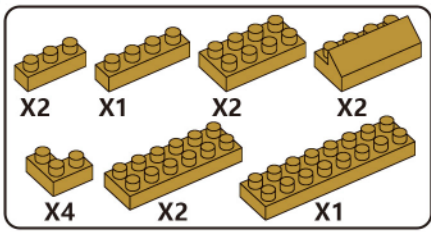

17

