



































- x16 
  - x2 
  - x19 
  - x8 
  - x30 
  - x2 
  - x2 
  - x4 
  - x3 
  - x4 
  - x27 
  - x16 
  - x34 
  - x13 
- x24 
  - x3 
  - x12 
  - x2 
  - x14 
  - x6 
  - x8 
  - x28 
  - x2 
  - x8 
- x6 
  - x6 
  - x6 
  - x8 
  - x3 
  - x14 
  - x3 
  - x12 

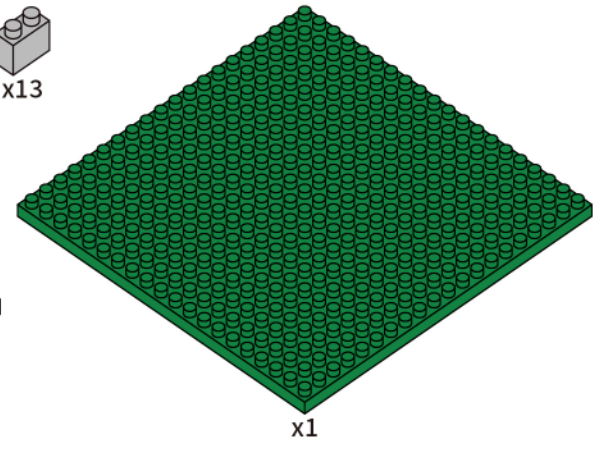

**1**

x16 

x8 

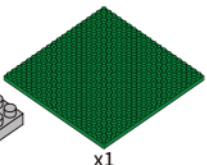
x1 

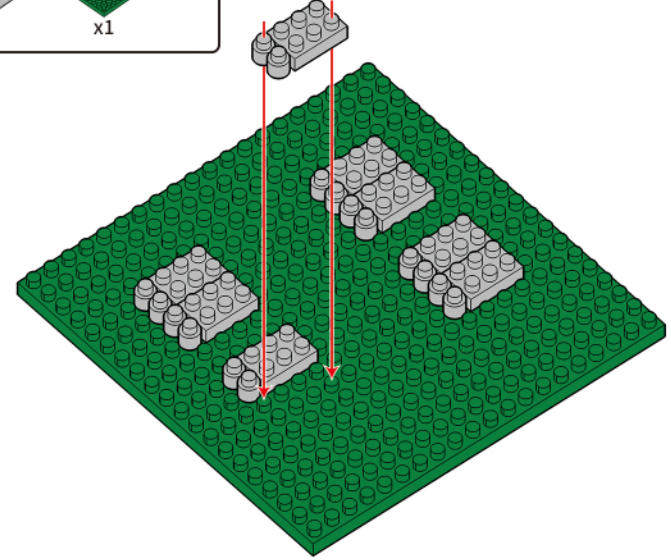

**2**

x8 

x8 

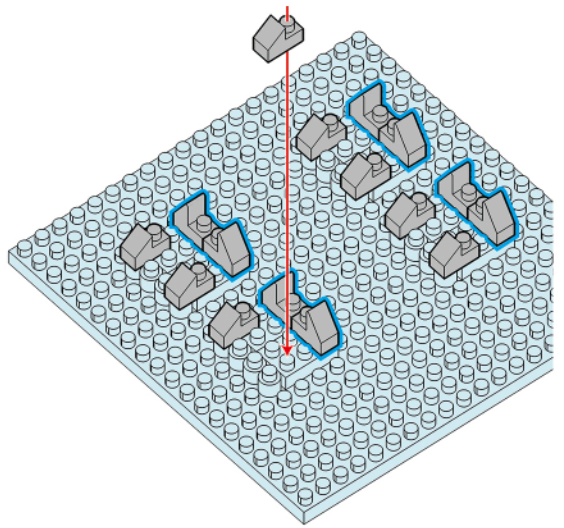

**3**

x8 

x4 

x4 

x4 

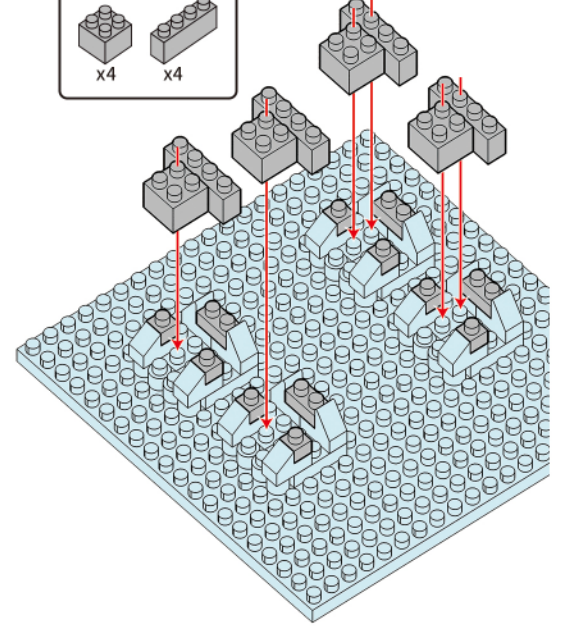

**4**

x4 

x8 

x8 

x4 

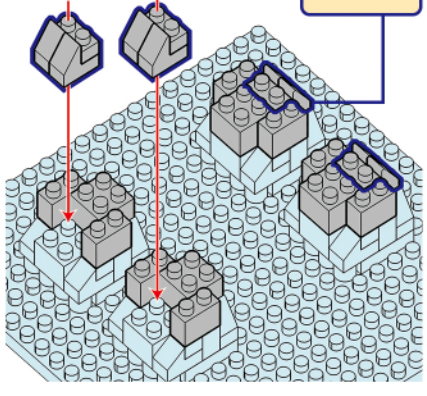



**5**

x4 

x2 

x8 

x2 

x2 

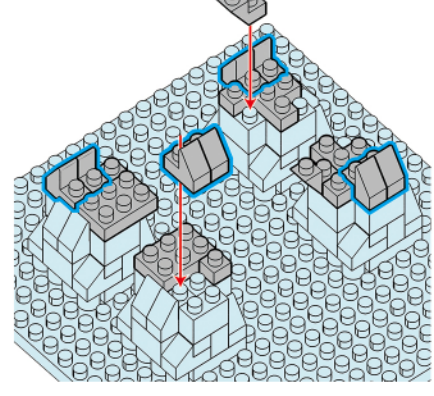

**6**

x2 

x6 

x2 

x4 

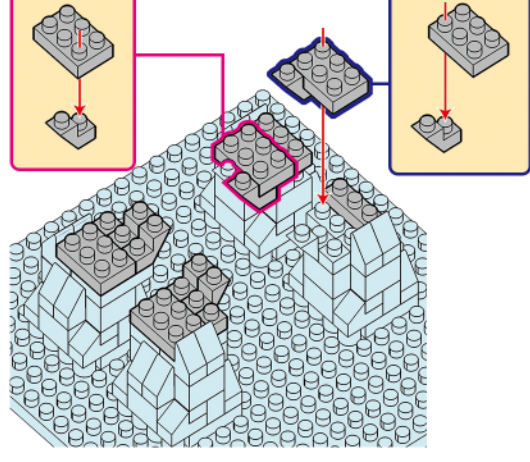



**7**

x1 

x2 

x1 

x1 

x2 

x3 

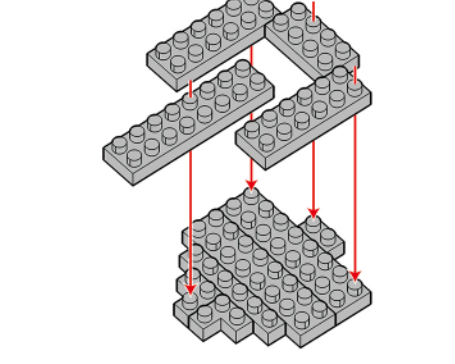



**8**

x2 

x2 

x2 

x2 

x3 

x2 

x1 

x1 

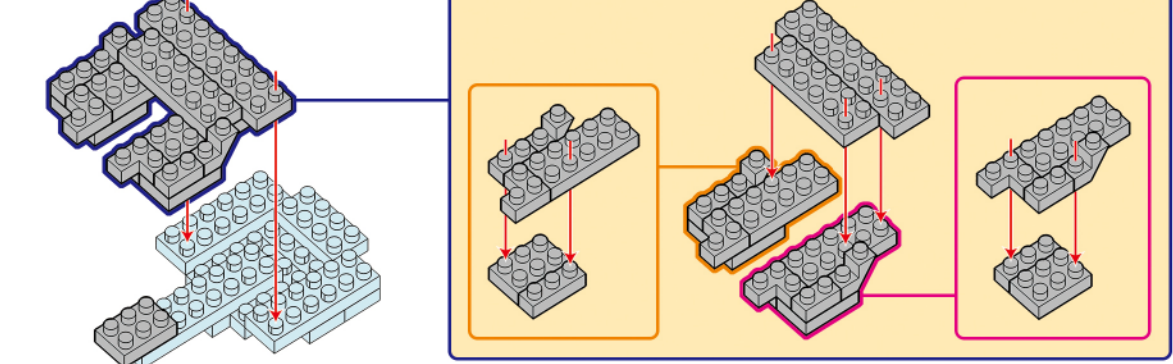

**9**

x4 

x2 

x3 

x4 

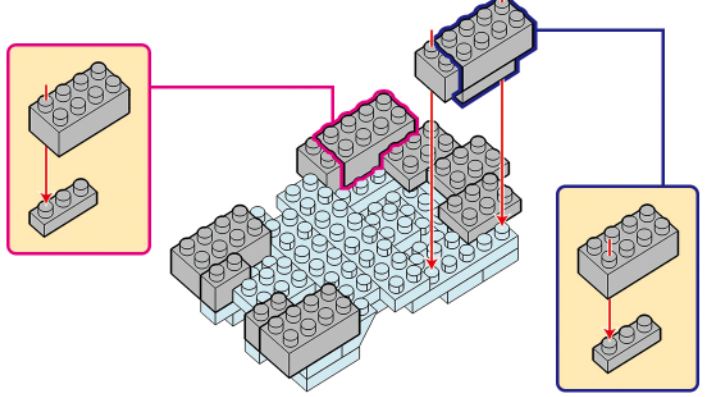

**10**

x4 

x1 

x1 

x1 

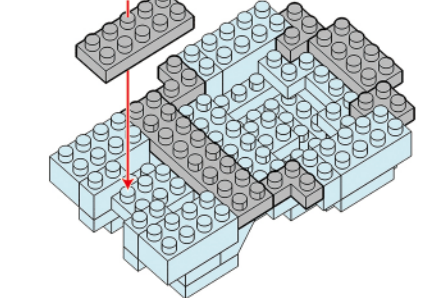



**11**

x2 

x2 

x2 

x2 

x2 

x1 

x1 

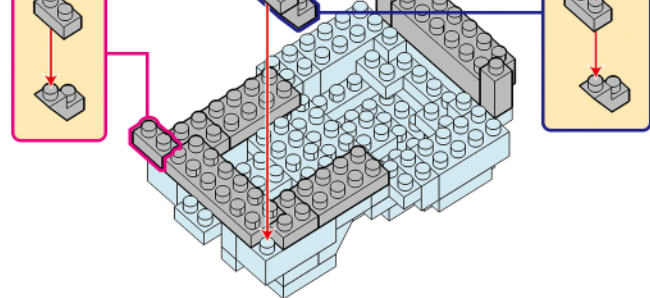



**12**

x2 

x4 

x2 

x2 

x2 

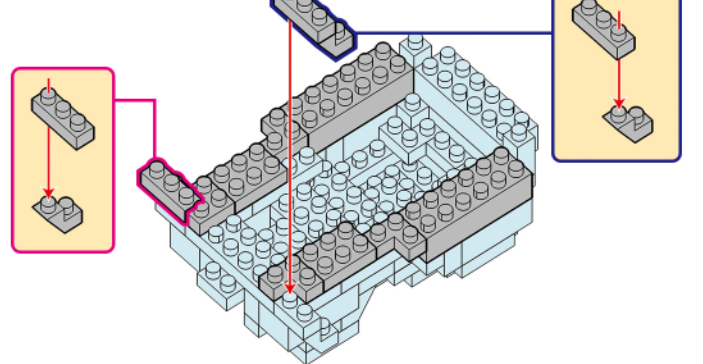



13

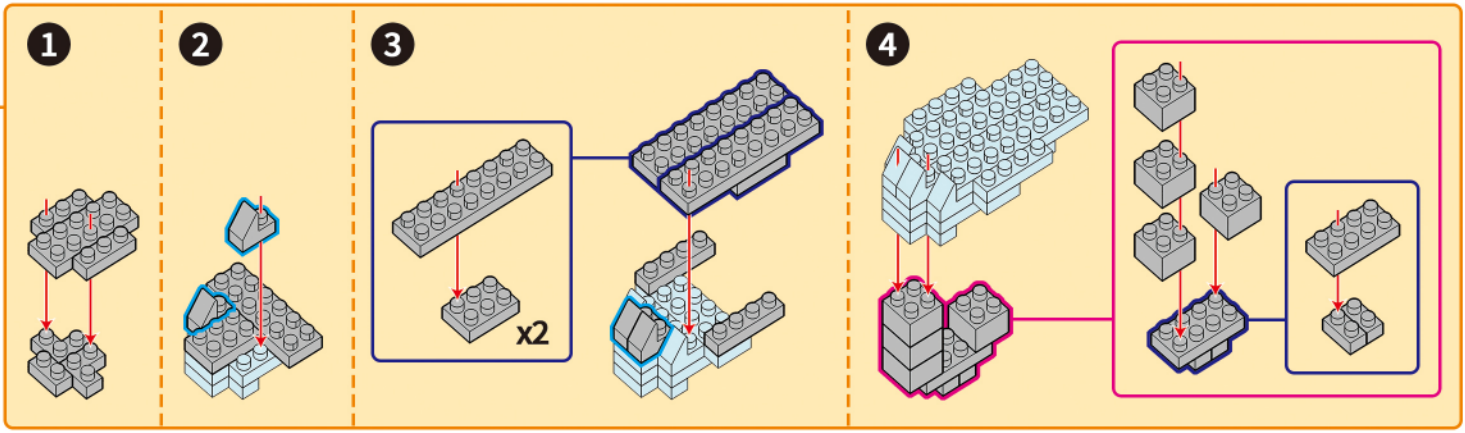
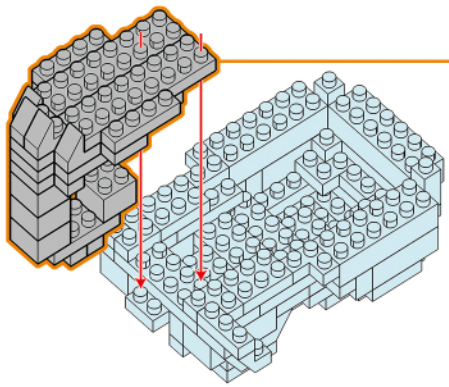
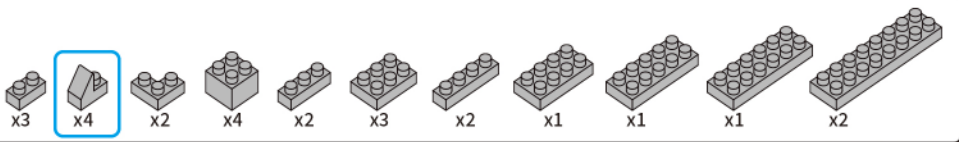

14

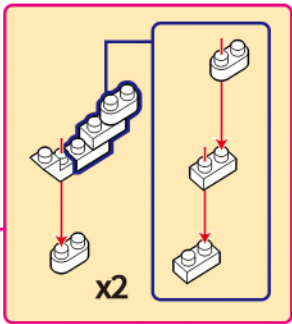
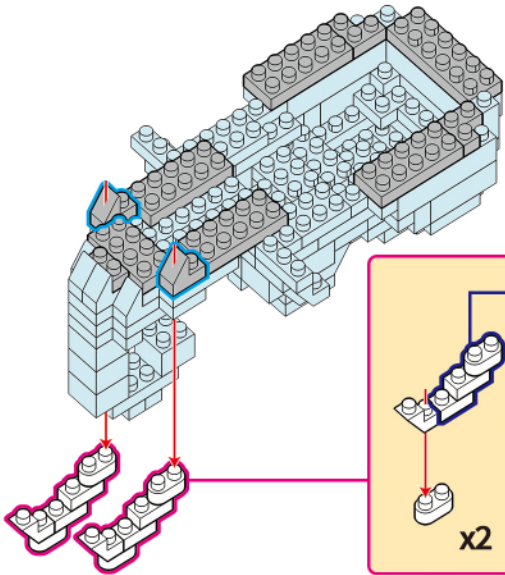
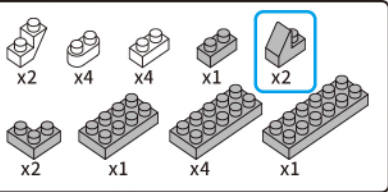

15

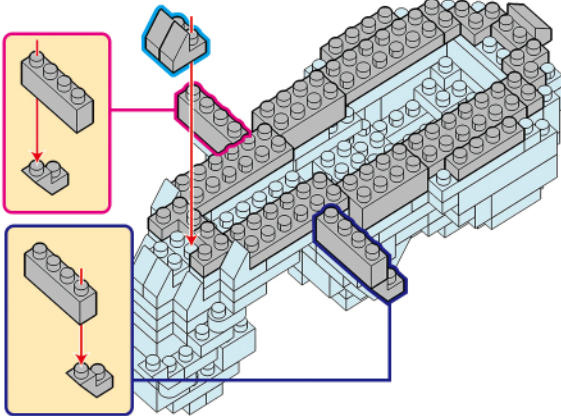
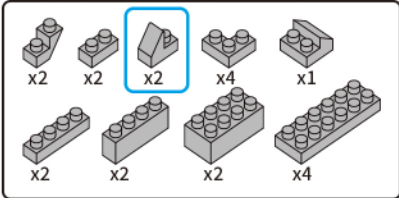

16

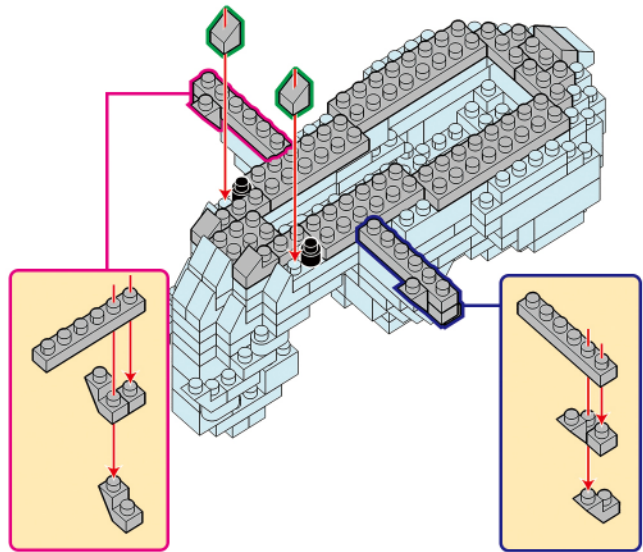
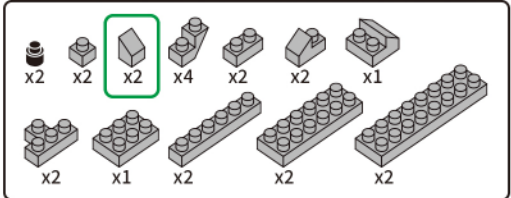

17

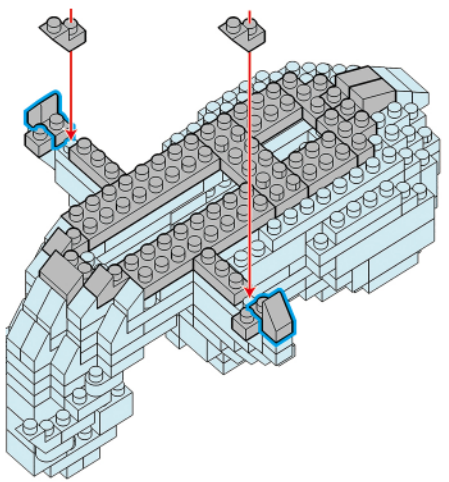
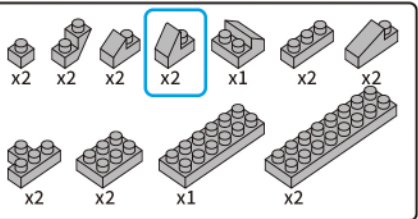

18

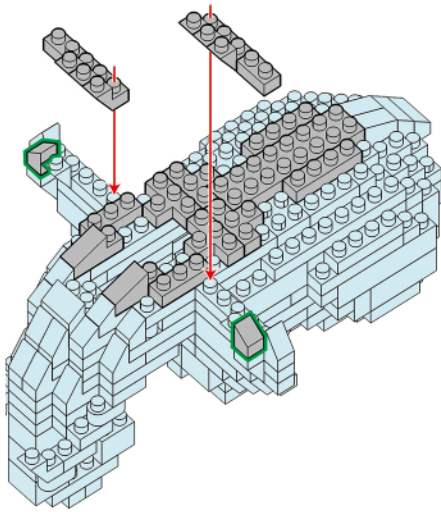
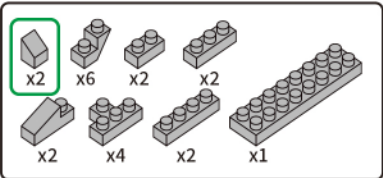

19

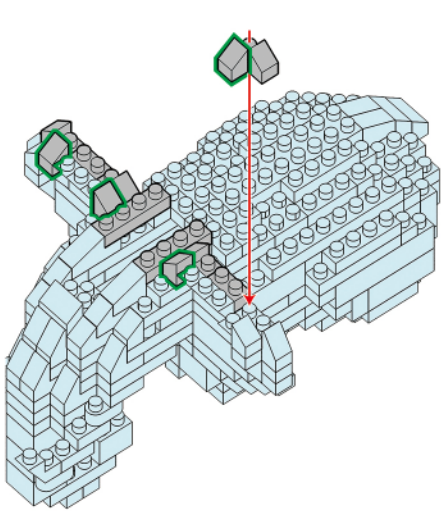
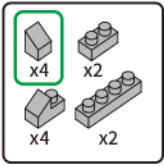

20

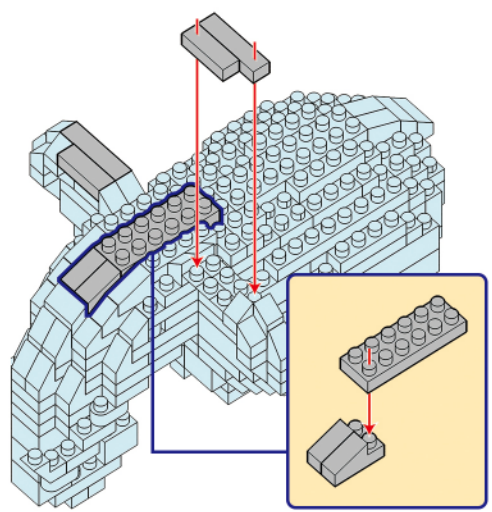
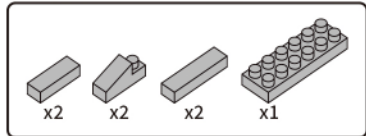

21

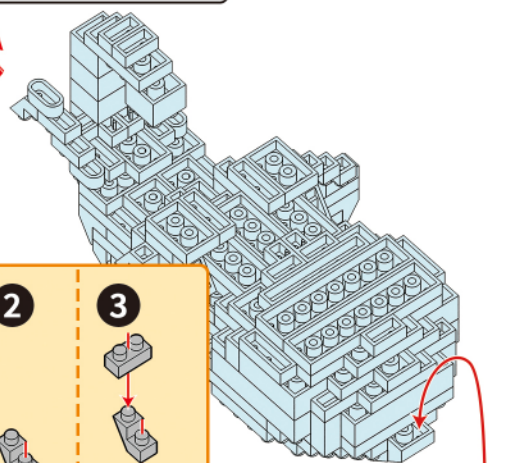
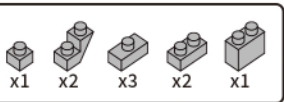

22

21

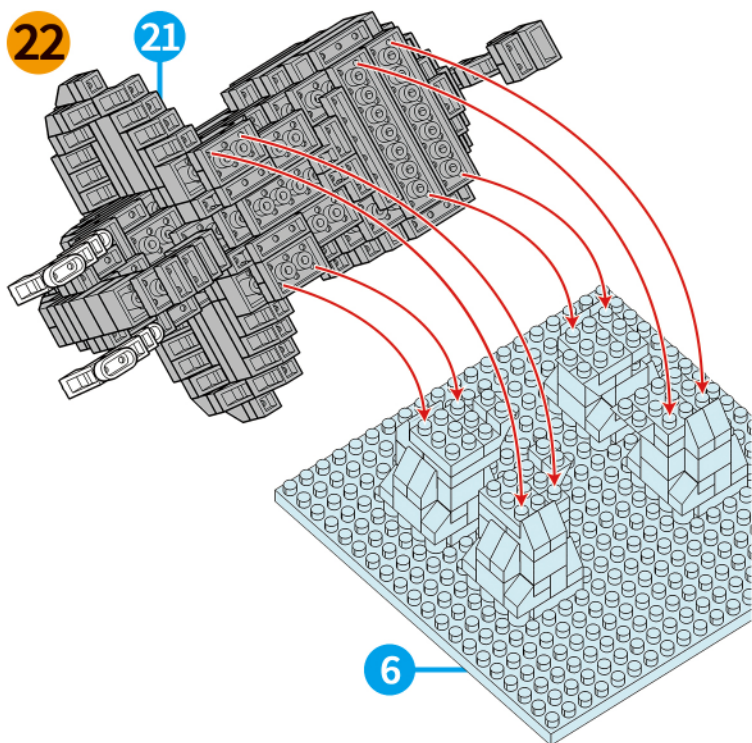

6

