

- 10
- x5 x5 x10 x1 x2 x7 x7 x2 x6 x1 x2 x2

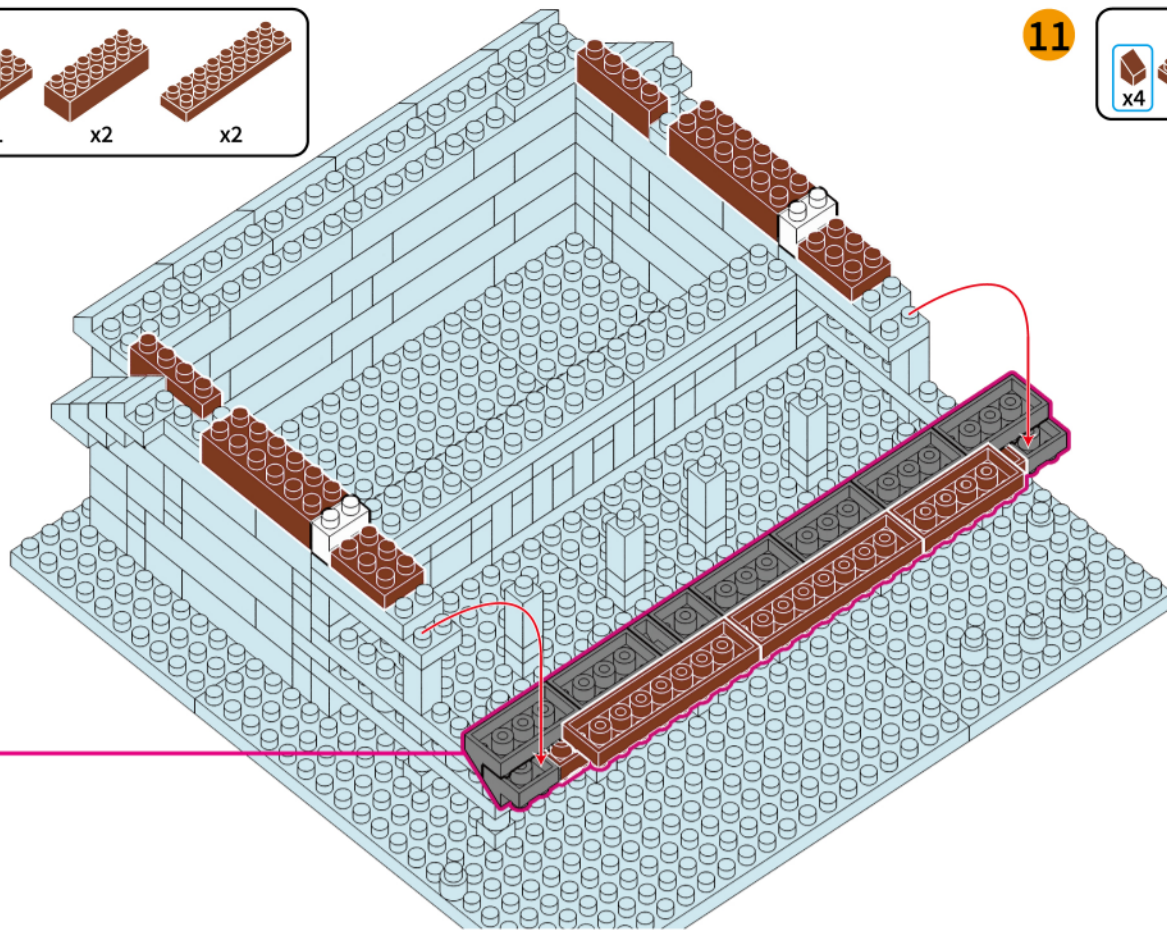

- 11
- x4 x2 x3 x2 x7 x1 x15

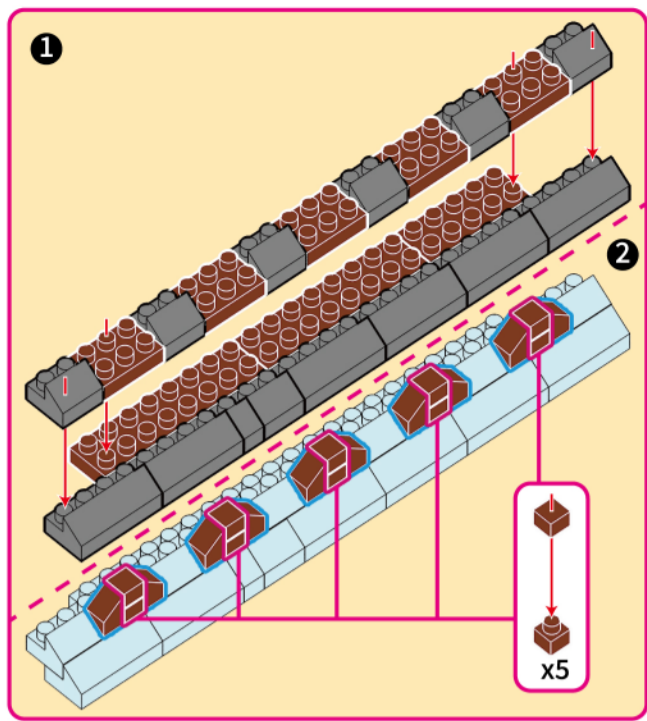
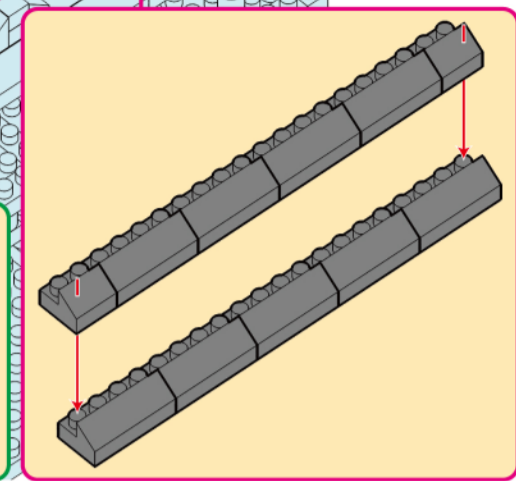
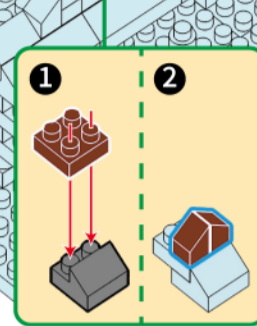
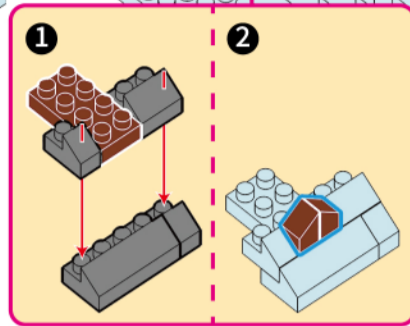

- 12
- x1 x2 x3 x2 x1 x2 x9 x2

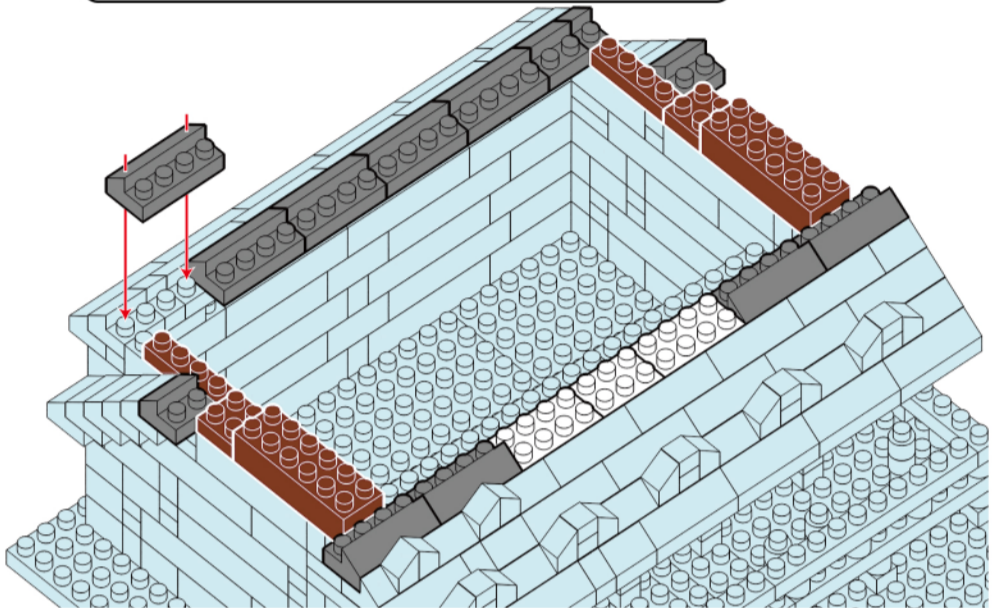

- 13
- x2 x5 x2 x2 x2 x5 x2 x5 x1

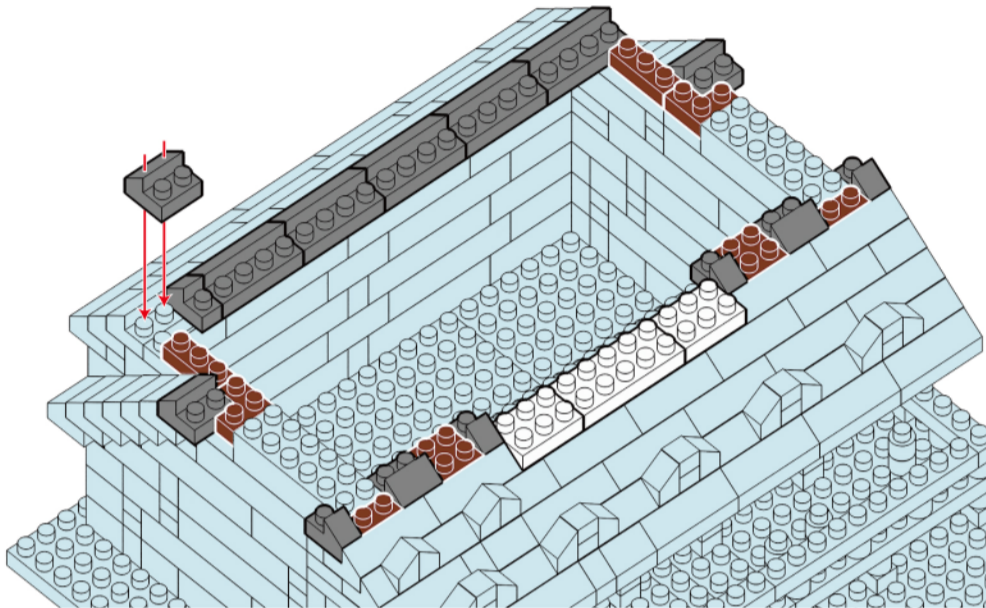

- 14
- x8 x1 x3 x11 x2 x2 x9

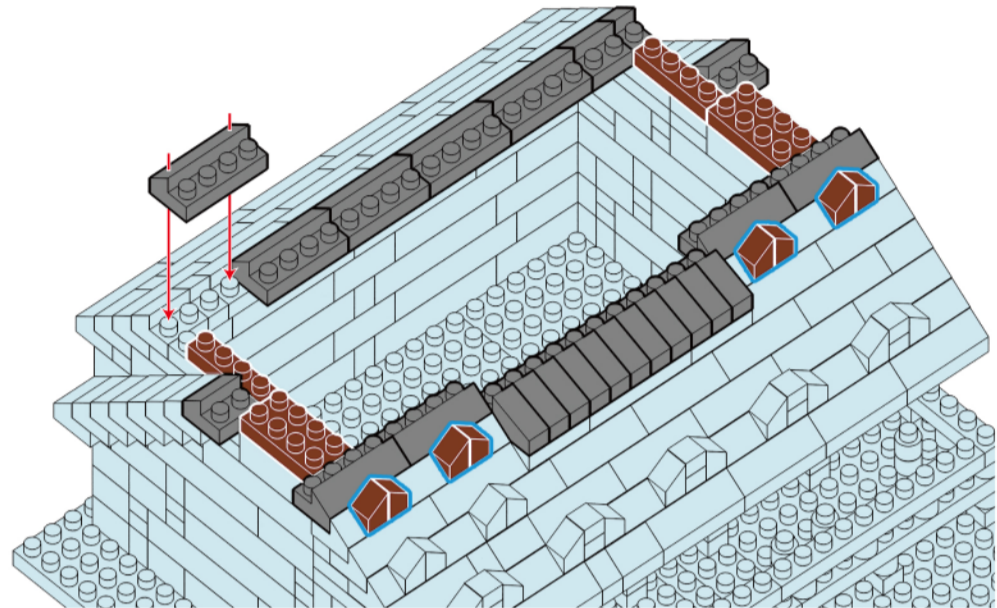

- 15
- x4 x2 x1 x2 x4 x2 x8

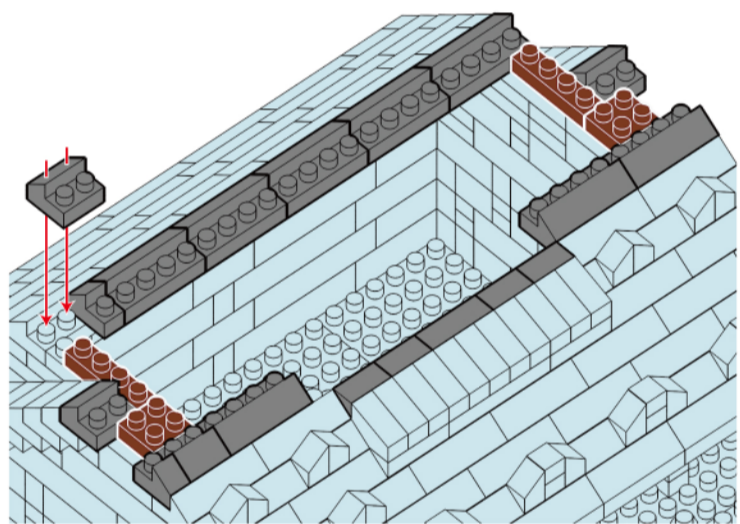

- 16
- x2 x4 x2 x14

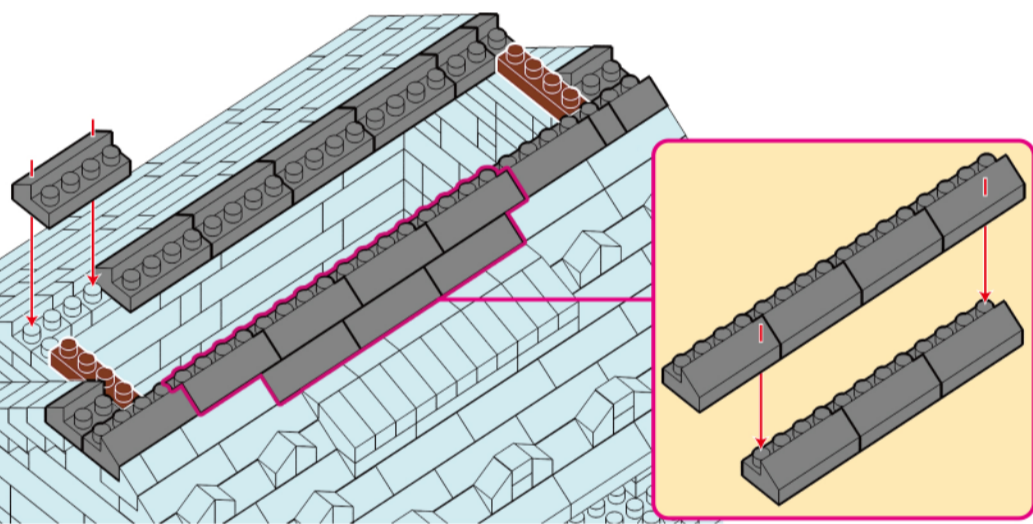

- 17
- x8 x2 x2 x2 x10

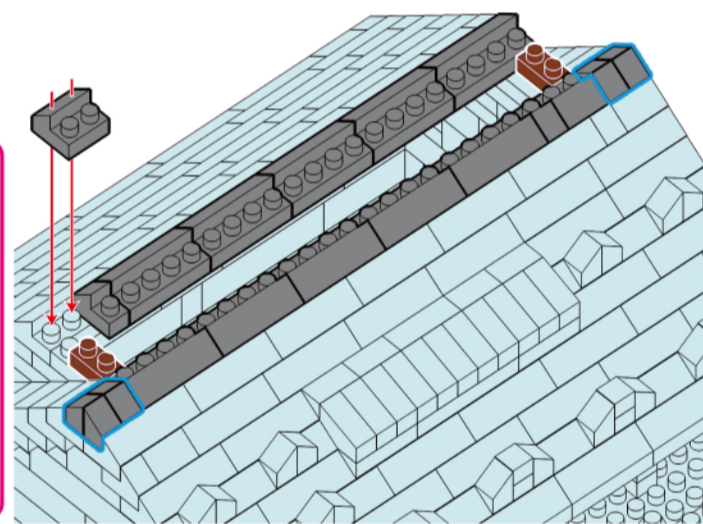

- 18
- x3 x1 x3 x1 x5 x1

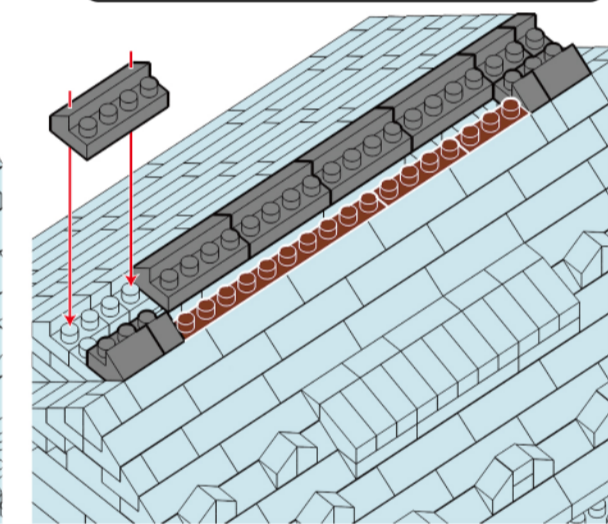

- 19
- x12 x1 x1 x1 x4 x1

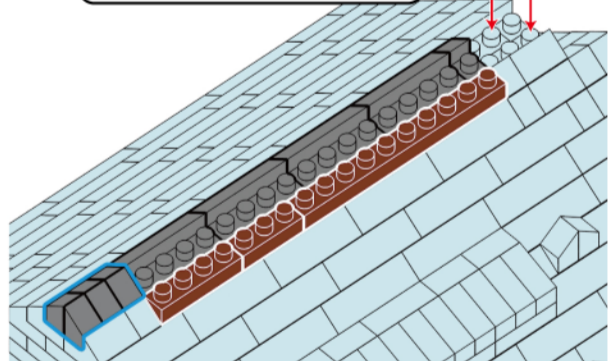

- 20
- x1 x1 x1 x1 x4 x1 x1 x1 x1 x1 x2

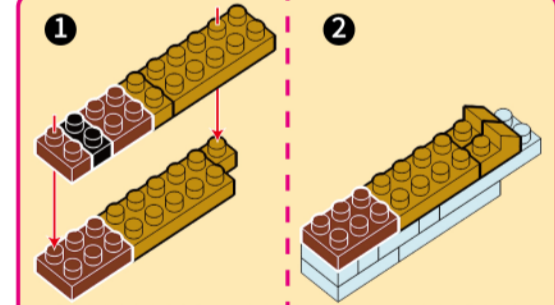
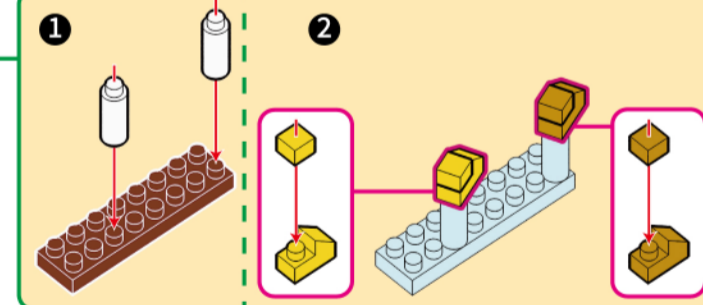
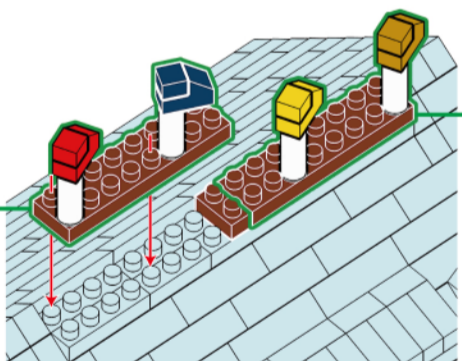
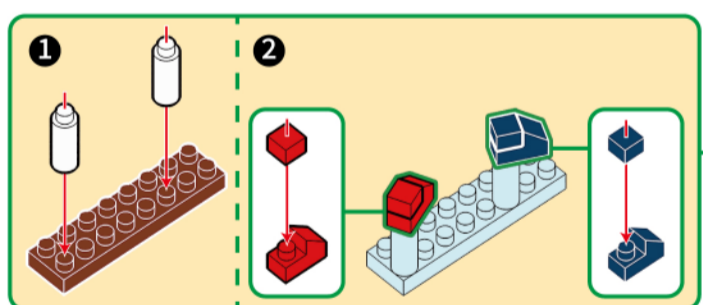

- 21
- x2 x2 x6 x1 x7 x6 x6 x4 x3 x10 x5 x2 x1 x3 x2 x2 x6 x3 x12 x1 x4 x1 x1 x4 x6 x2 x3 x2 x3 x4 x1 x1 x5 x2

