

X2	X4	X4	X4	X2	X6	X10	X16	X5	X3	X9	X1	X11	X4	X6	X21	X5	X18	X13	X12	X16	X4	X7	X6	X6	X4	X8	X8	X5	X14	X12	X10
X2	X2	X22	X7	X1	X10	X2	X10	X6	X2	X5	X4	X2	X5	X5	X16	X2	X12	X3	X2	X10	X1	X1	X1	X1	X1	X1	X11	X2			
X2	X4	X6	X13	X4	X8	X2	X2	X1	X2	X2	X7	X15	X1	X4	X2	X4	X2	X4	X2	X4	X2	X4	X2	X4	X2	X4	X4	X2	X2		
X3	X4	X9	X7	X4	X2	X7	X2	X10	X1	X18	X2	X13	X3	X2	X1	X6	X1	X6	X1	X6	X1	X6	X1	X6	X1	X6	X1	X6	X1		

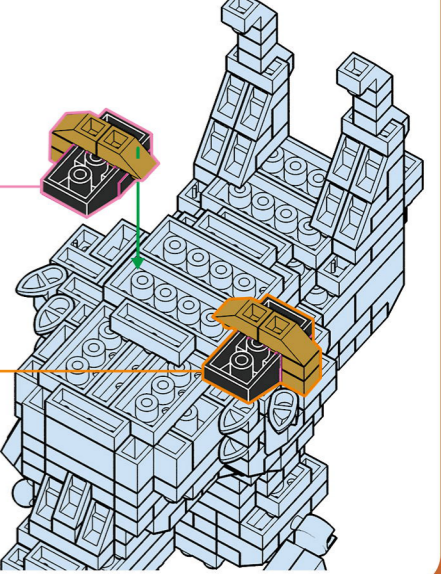

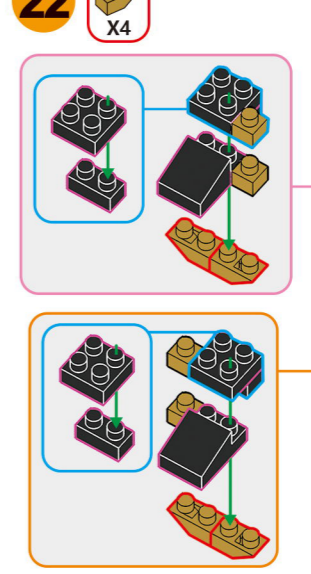
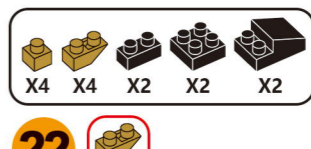
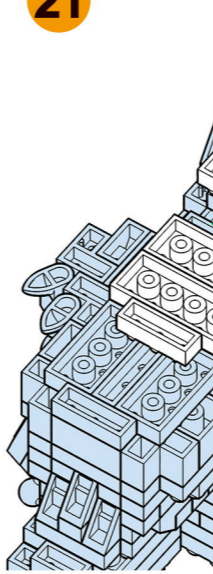
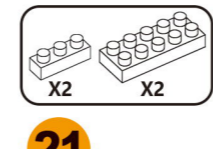
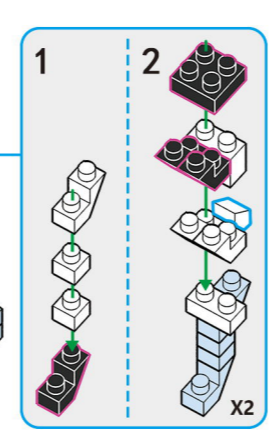
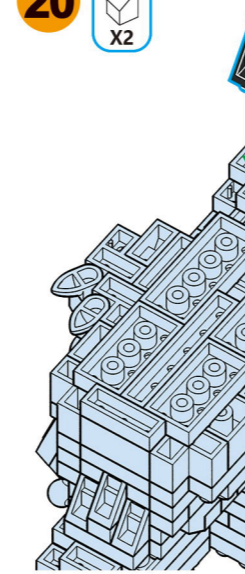
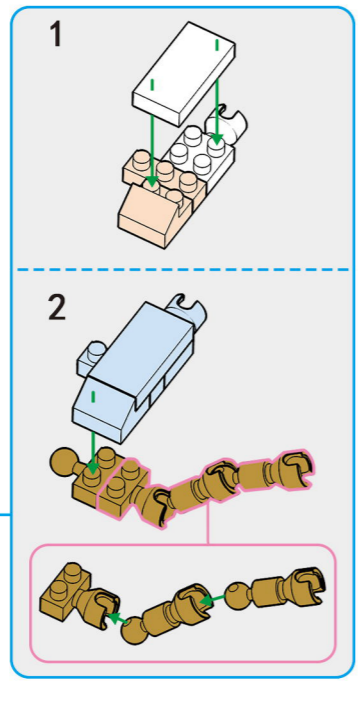
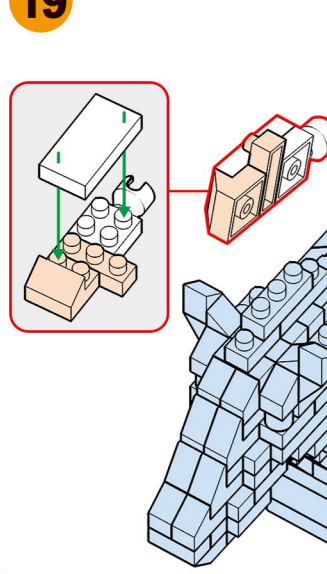
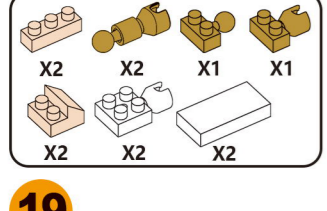
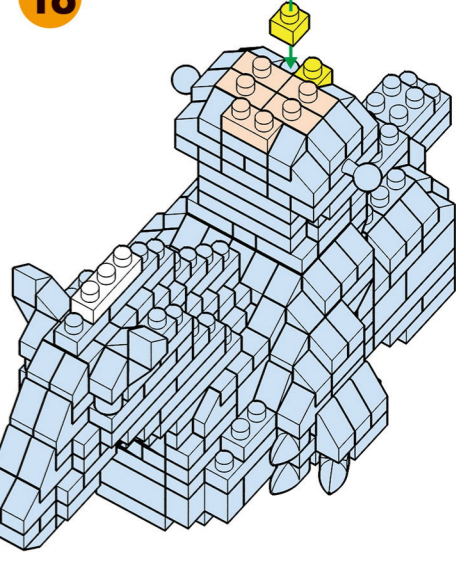
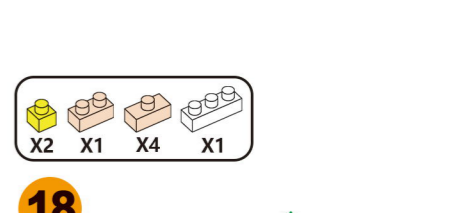
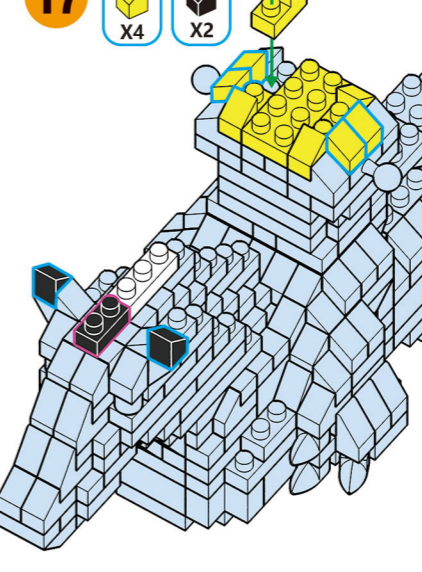
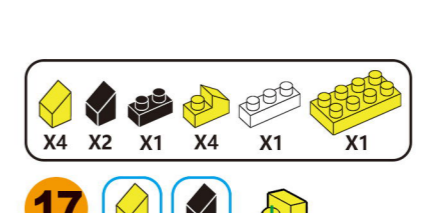
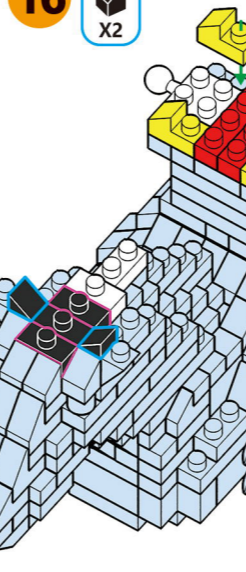
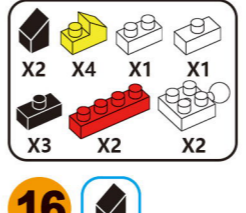
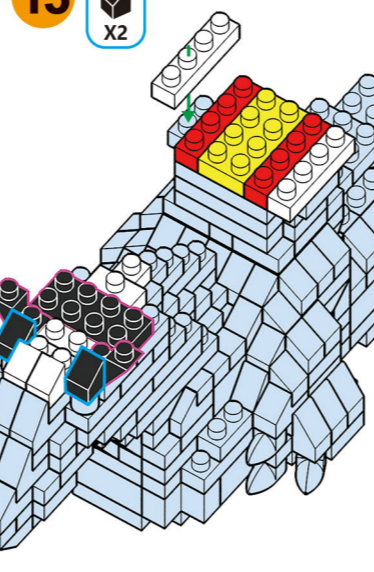
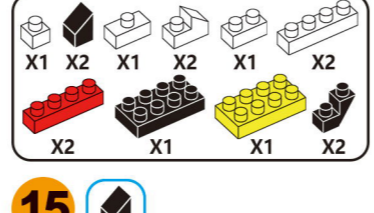
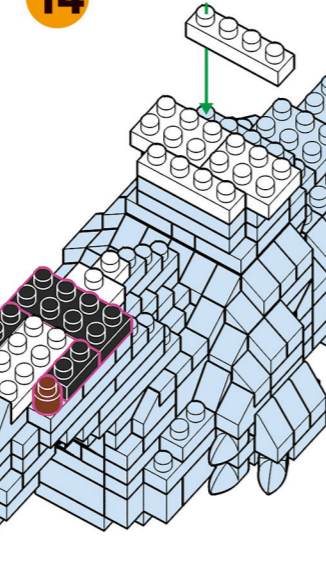
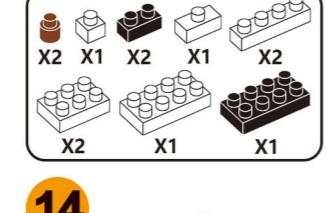
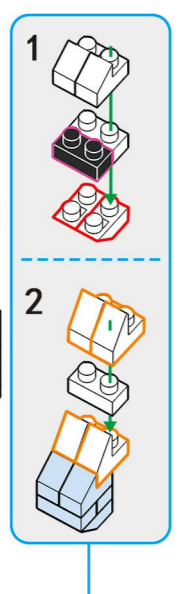
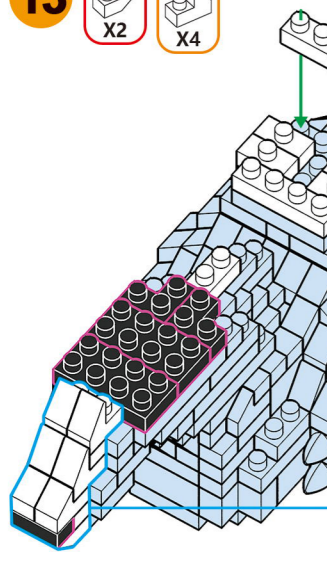
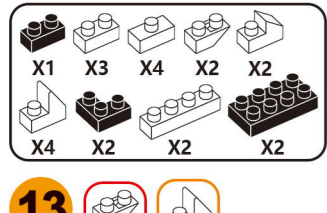
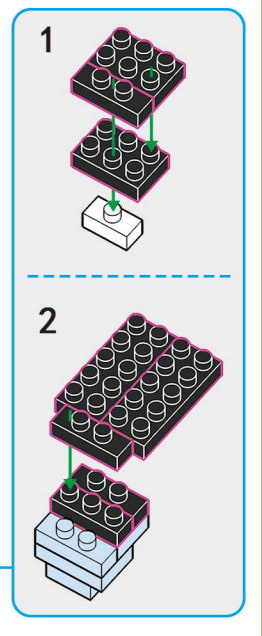
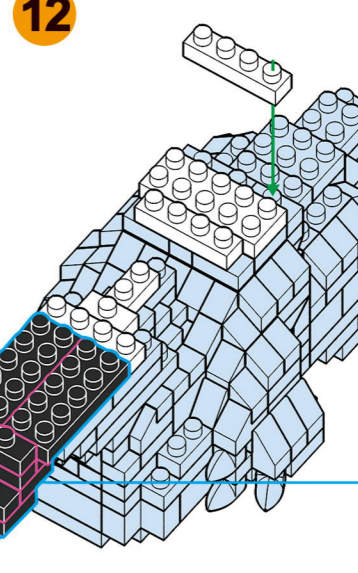
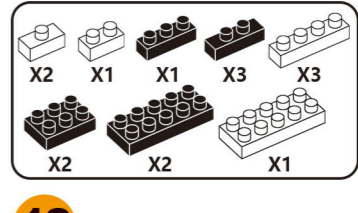
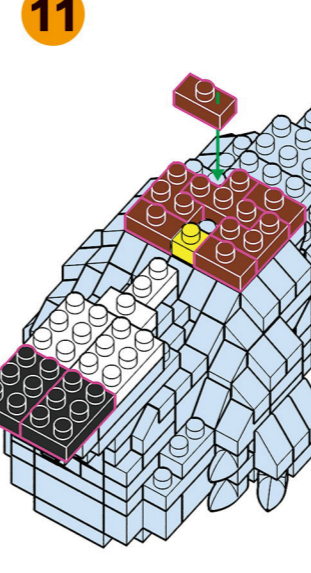
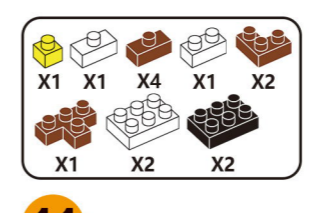
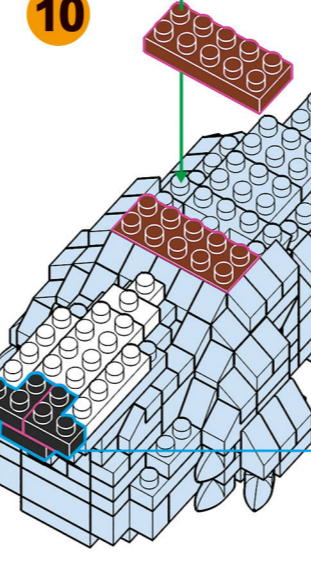
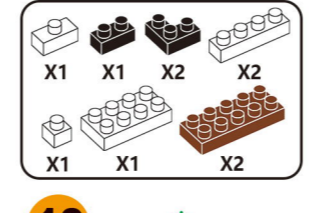
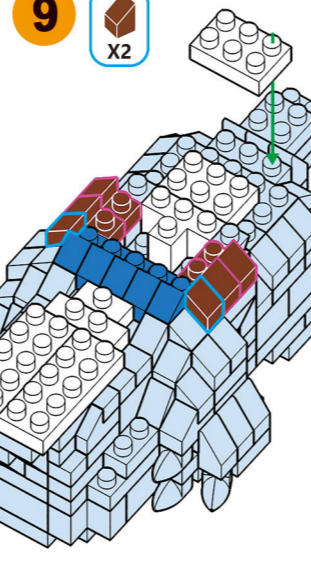
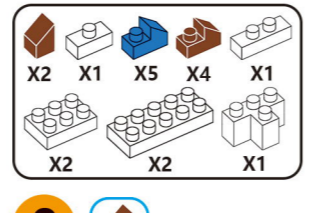
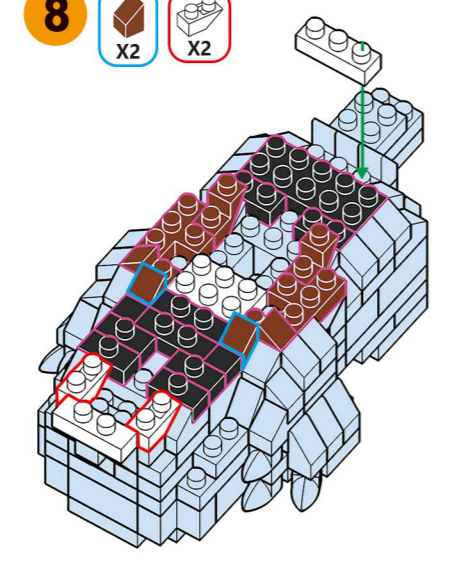
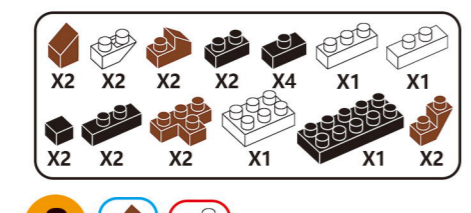
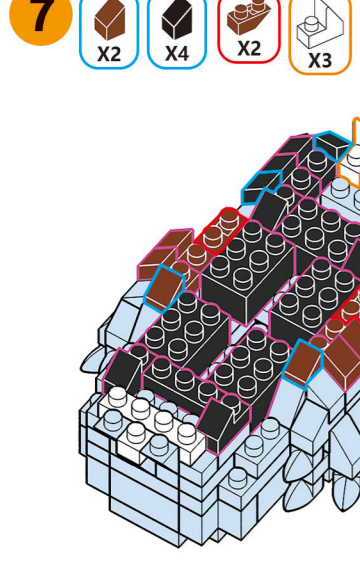
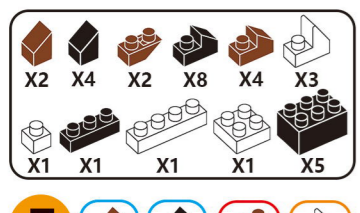
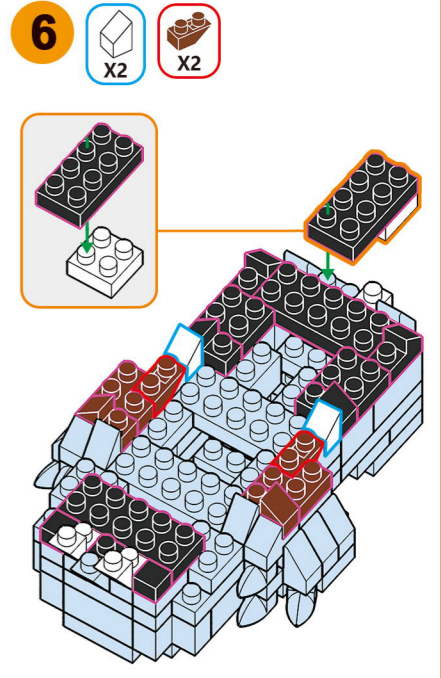
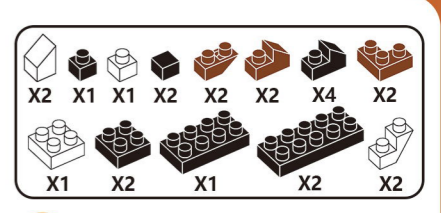
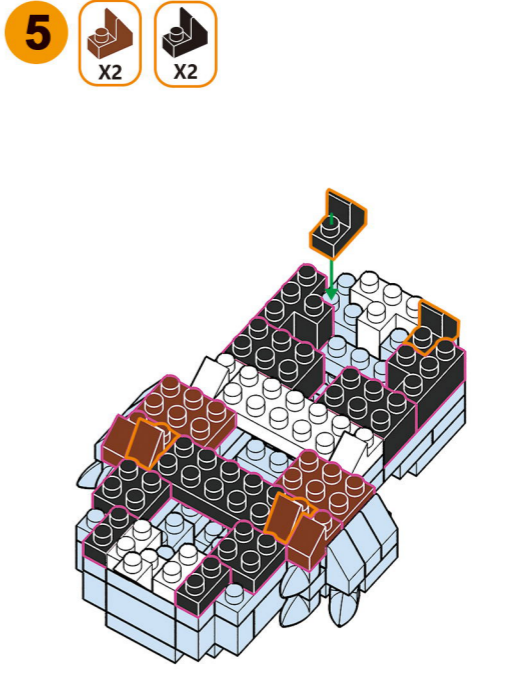
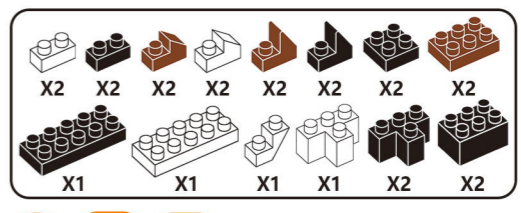
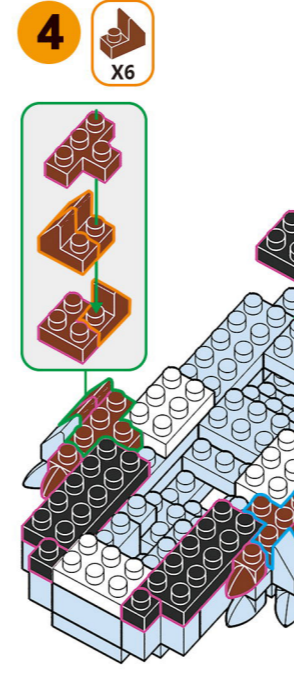
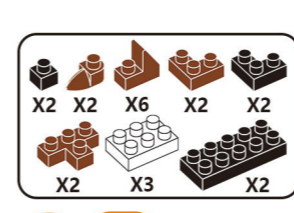
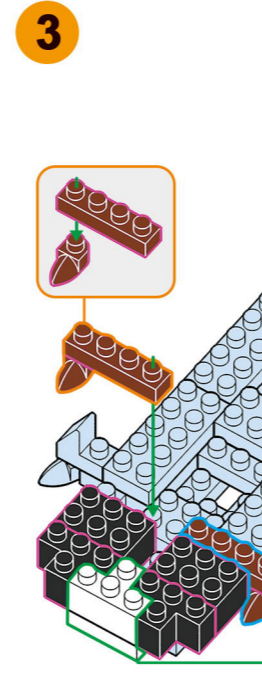
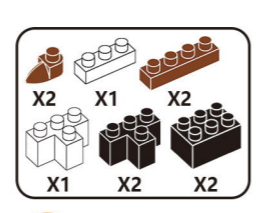
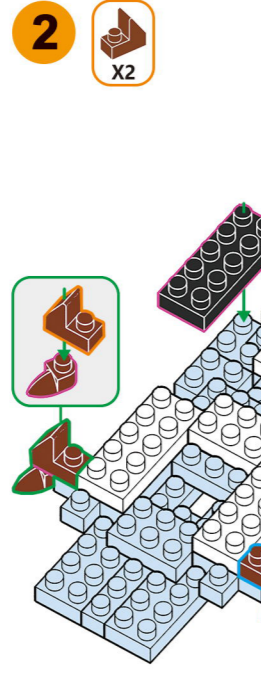
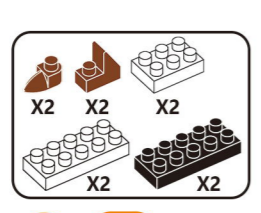
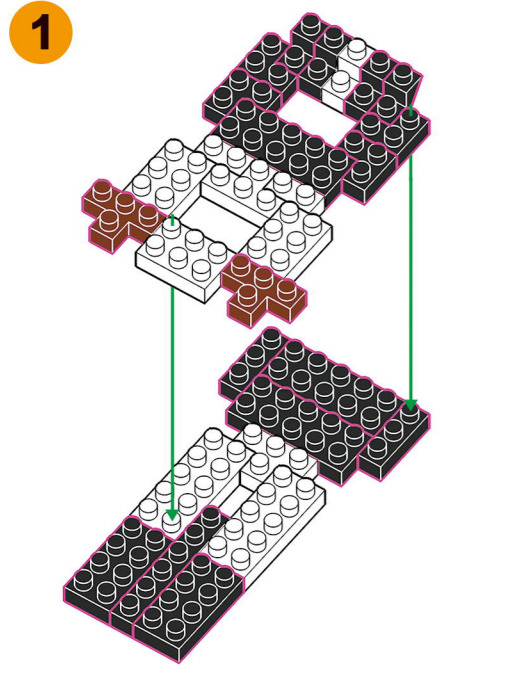
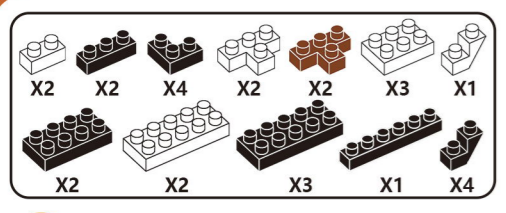

**23** X2 X1  
**24** X1 X1 X1  
**25** X2 X1 X4 X1  
**26** X2 X1  
**27** X1 X1 X1  
**28** X2 X1 X4 X1  
**29** X2 X1  
**30** X1 X1  
**31** X1 X1 X1 X2 X1  
**32** X1 X3 X1 X1  
**33** X1 X2  
**34** X1 X2

**35** X2 X2  
**36** X2 X1  
**37** X2 X1  
**38** X3  
**39** X3 X2  
**40** X2 X1 X1 X1 X1  
**41** X1  
**42** X2 X2 X2 X2  
**43** X2 X1 X5 X2 X1  
**44** X2 X1 X1  
**45** X2 X1 X1

**46** X2 X1 X1 X4 X2  
**47** X1 X5  
**48** X2 X1 X3  
**49** X2 X4 X4 X8 X4  
**50** X2 X2 X2 X2 X2 X3

**51** X2 X3  
**52** X2 X2 X4  
**53** X1 X1 X1  
**54** X1 X1  
**55** X2 X2 X1 X1  
**56** X2  
**57** X2 X1 X1 X1  
**58** X2 X1 X1 X1

**59** X4  
**60** X2 X2  
**61** X4  
**62** X2 X2  
**63** X4  
**64** X2 X1  
**65** X8

**66** X2 X4 X6 X1  
**67** X2 X4 X6 X1  
**68** X2 X4 X6 X1  
**69** X2 X4 X6 X1