



openTRANS[®] Version 2.1

02.10.2009

ORDER

Authors:

Volker Schmitz, Universität Duisburg-Essen
Oliver Kelkar, formerly Fraunhofer IAO (up to Version 2.0 Beta v0.8)
Boris Otto, formerly Fraunhofer IAO (up to Version 1.0)
Nico Weiner, Fraunhofer IAO (since Version 2.0)

Contact persons:

Volker Schmitz	Nico Weiner
University of Duisburg-Essen,	Fraunhofer IAO
BLI	http://www.iao.fhg.de
http://www.bli.uni-due.de	

Contact E-Mail: authors@opentrans.org

Copyright © 1998 – 2009 Fraunhofer IAO, Stuttgart; University Duisburg-Essen BLI

Legal Status

Fraunhofer IAO and the University of Essen hereby grant you the permanent, non-exclusive, royalty-free, world-wide right and the license to use the openTRANS[®]-Specification and to use, copy, publish and distribute same in compliance with the copyrights indicated in the specification. Fraunhofer IAO and the University of Essen hereby declare themselves willing to grant you a royalty-free license, in accordance with copyright laws, for the implementation and use of the openTRANS[®]-Tags and Guidelines for the creation of computer programs in accordance with these guidelines. This license is granted under the condition that you do not assert any copyright claims vis-a-vis Fraunhofer IAO and the University of Essen BLI or other companies for their implementation. Fraunhofer IAO and the University of Essen BLI expressly retain all other rights to the material and the subject of the specifications. Fraunhofer IAO and the University of Essen BLI expressly decline any type of guarantee for the specification, including guarantees that this specification or its implementation does not infringe on the rights of third parties. If you publish, Copyright © 2000 – 2009 Fraunhofer IAO, Stuttgart; Universität Essen BLI - openTRANS[®] V2.X copy or distribute this specification, it must carry a copyright reference. If, however, you alter the specification, the name of the altered specification may under no circumstances contain the term "openTRANS[®]" and the following reference must be contained in the amended version: "Parts of this specification are based on the openTRANS[®] Standard V2.X (Copyright © 2000-2009 Fraunhofer IAO and University of Essen BLI)".

"openTRANS" is a registered trademark of "Fraunhofer Gesellschaft e.V".

We reserve the right to make changes to the information contained in this document without prior notice.

Remarks, additions, improvement suggestions and errors can be passed on to the authors under the e-mail address authors@opentrans.org. They will be included in later versions of the standard.

Organizations and individuals who have registered under <http://www.opentrans.org> and downloaded the Standard, will be informed per e-mail of any alterations and new versions.

Firms and individuals involved in the development of openTRANS®

Since publication of openTRANS® version 1.0 in september 2001 many change-, extension- and improvement-requests reached us. Thought has been given to these requests in the development of openTRANS® 2.0 and openTRANS® 2.1. At this point the openTRANS® authors want to thank all the people who have contributed to a better performance and quality of the standard. Many thanks to Stefan Fröhlich, epaxios.com, for the extended Review of the standard and the detailed feedback. In addition to the contributors to the development of BMEcat® up to version 2005 and openTRANS® version 1.0 we want to thank particularly the group of participants who supported us at the openTRANS®-Development-Workshops (in alphabetical order by company-name):

- Mr. Gerd Puf, Adulo GmbH
- Mr. Reinhard Nachtsheim, AlphaPlus Trusted Services GmbH
- Mr. Ralph Höppner, businessMart AG
- Mr. Stefan Schäufele, businessMart AG
- Mr. Michael Deckert, BDS GmbH
- Mr. Thomas Kuckartz, Cantor Software GmbH
- Mr. Marc Linker, Cantor Software GmbH
- Mr. Dieter Laukemann - DATEV eG
- Mr. Asmus Hammer, eBanking Services Nord GmbH
- Mr. Thomas Renner, Fraunhofer IAO
- Mr. Nico Weiner, Fraunhofer IAO
- Mr. Oliver Kindermann, Inoutic/Deceunick GmbH
- Mr. Jörg Glaser, ServiCon Service & Consult EG
- Mr. Helmut Halter, VBH Deutschland GmbH
- Mr. Herbert Sauermann, VBH Deutschland GmbH
- Mr. Donald Müller-Judex, XimantiX GmbH
- Dr. Jörg-Ulrich Wölfel, XimantiX GmbH
- Dr. Oliver Kelkar, MHP mbH

Table of Contents

1	Introduction	7
1.1	Overview	7
1.2	Use of XML	7
1.3	Supplementary activities and standards	7
1.4	Implementation support	7
1.5	Website www.opentrans.org	7
2	Specification	8
2.1	Terminology	8
2.2	Structure of the specification	8
2.3	Description of elements	8
2.4	Must- and Can-fields	10
2.5	Data types	11
2.6	Coding in XML	12
2.7	History of openTRANS versions	12
3	Dataexchange with openTRANS 2.x	12
3.1	document structure	12
3.1.1	Header-Level	12
3.1.2	Item-Level	12
3.1.3	Summary	12
3.2	Multilingual documents	13
3.3	Changes in openTRANS 2.0	13
3.4	Changes in openTRANS® 2.1	13
3.5	Downward compatibility zu openTRANS 1.0	13
3.6	Compatibility with BMEcat®	13
	Reference of elements	14
	ORDER	15
	ORDER_HEADER	17
	CONTROL_INFO	18
	SOURCING_INFO	19
	AGREEMENT	20
	SUPPLIER_IDREF	23
	MIME_INFO	24
	MIME	26
	FILE_HASH_VALUE	32
	MIME_EMBEDDED	34
	MIME_DATA	36
	CATALOG_REFERENCE	37
	ORDER_INFO	38
	DELIVERY_DATE	43
	LANGUAGE	45
	PARTIES	46
	PARTY	47
	PARTY_ID	52
	ADDRESS	53
	CONTACT_DETAILS	58
	CONTACT_ROLE	61
	PHONE	62
	FAX	63
	EMAILS	64

PUBLIC_KEY	65
AUTHENTICATION	66
ACCOUNT	67
BANK_ACCOUNT	69
BANK_CODE	71
CUSTOMER_ORDER_REFERENCE	72
CUSTOMER_IDREF	74
ORDER_PARTIES_REFERENCE	75
BUYER_IDREF	76
INVOICE_RECIPIENT_IDREF	77
SHIPMENT_PARTIES_REFERENCE	79
DELIVERY_IDREF	80
FINAL_DELIVERY_IDREF	81
DELIVERER_IDREF	82
DOEXCHANGE_PARTIES_REFERENCE	83
DOCUMENT_ISSUER_IDREF	84
DOCUMENT_RECIPIENT_IDREF	85
PAYMENT	86
CARD	88
PAYMENT_TERMS	90
PAYMENT_TERM	92
TIME_FOR_PAYMENT	93
ALLOW_OR_CHARGES_FIX	95
ALLOW_OR_CHARGE	97
ALLOW_OR_CHARGE_VALUE	101
AOC_ORDER_UNITS_COUNT	103
TRANSPORT	104
INTERNATIONAL_RESTRICTIONS	105
REMARKS	106
ORDER_ITEM_LIST	108
ORDER_ITEM	109
PRODUCT_ID	117
SUPPLIER_PID	122
INTERNATIONAL_PID	124
BUYER_PID	125
MANUFACTURER_INFO	126
MANUFACTURER_IDREF	127
PRODUCT_FEATURES	128
REFERENCE_FEATURE_GROUP_ID	133
REFERENCE_FEATURE_GROUP_ID2	134
FEATURE	135
FTEMPLATE	141
FT_VERSION	144
FT_DEPENDENCIES	146
FEATURE_CONTENT	147
FT_FACETS	152
FT_FACET	154
FT_VALUES	156
FT_VALUE	157
VALUE_RANGE	160
STARTVALUE	161

ENDVALUE	162
FT_SYNONYMS	163
FT_SOURCE	164
PARTY_IDREF	166
PRODUCT_COMPONENTS	167
PRODUCT_COMPONENT	168
PRODUCT_PRICE_FIX	170
PRICE_FLAG	172
TAX_DETAILS_FIX	174
PRICE_BASE_FIX	177
PARTIAL_DELIVERY_LIST	178
PARTIAL_DELIVERY	179
ACCOUNTING_INFO	180
COST_CATEGORY_ID	181
SPECIAL_TREATMENT_CLASS	182
ORDER_SUMMARY	183
Index	184
Annex	187
Basic data types	188
Enumeration data types	190
Special data types	192
History of changes - Version 2005fd	193
History of changes - Version 2005	198
History of changes - Version 20v1	200
History of changes - Version 20v2	201
History of changes - Version 20v3	204
History of changes - Version 20fd	206
History of changes - Version 20	207
History of changes - Version 21fd	208
History of changes - Version 21	209
Overview of elements - order by appearance	210
Overview of elements - alphabetical order	224

1 Introduction

1.1 Overview

The openTRANS[®] format was developed with the aim of providing uniform electronic documents for business-to-business es-commerce. Based on the BMEcat[®] Standard for the electronic exchange of product data, standardized business documents such as order, delivery notes, invoices, etc. can be exchanged between the business partners and electronic marketplaces. This specification addresses users and developers of the openTRANS[®]-standard. The related openTRANS[®]-Schema is only valid in combination with this document. This takes effect especially for multilingual elements which can be defined as *unbounded* in the openTRANS[®]-schema and *single* in this document (e.g. **CONTACT_NAME**). This is for compatibility reasons in case of more than one language in one(!) openTRANS[®]-file.

The openTRANS[®]-standard does not give information related to the transaction processes. It is up to the business partners to agree on which documents they use and how they implement the exchange of the documents.

The following business documents are specified in this document:

- **RFQ** (Request for quotation)
- **QUOTATION** (Quotation)
- **ORDER** (Order)
- **ORDERCHANGE** (Change of order)
- **ORDERRESPONSE** (Confirmation of the order)
- **DISPATCHNOTIFICATION** (Notification of dispatch)
- **RECEIPTACKNOWLEDGEMENT** (Acknowledgement of receipt of goods)
- **INVOICE** (Invoice)
- **INVOICELIST** (Collective invoice)
- **REMITTANCEADVICE** (Notification of remittance)

Additionally there is the possibility to use the credit memo as a special kind of an invoice (Attention: this might be valid only for german credit memos).

1.2 Use of XML

The openTRANS[®] business document data is stored as "eXtensible Markup Language" (XML) code. XML is a W3C recommendation (see www.w3.org) and a de-facto standard. XML allows structures and data to be coded simultaneously, in contrast with traditional methods such as comma-separated lists, for instance. The XML schema belonging to the openTRANS[®] standard are published in a separate, accompanying document.

1.3 Supplementary activities and standards

The BMEcat[®] Standard, which has been in existence since November 1999, describes an exchange format for electronic product catalogs. They constitute the range on offer in business-tobusiness e-commerce. The interaction of the business partners is described by the openTRANS[®] business documents.

The openTRANS[®]- business documents are being developed in partnership with BMEcat[®].

1.4 Implementation support

Fraunhofer IAO, the University of Essen BLI and various partners of the eBusiness Standardization Committee can provide consulting support for implementing the openTRANS[®] Standard. All inquiries in this respect or concerning the specification should be addressed directly to the authors of the openTRANS[®] standard: authors@opentrans.org

Additional information can also be found under <http://www.opentrans.org>.

1.5 Website www.opentrans.org

On the webpage <http://www.opentrans.org> the following release-related informations are published in

german and english language:

- Download of the specifications in different formats (.chm and .pdf)
- Download of the specifications as XML-Schema
- Download of examples

Via the webpage you can submit errors and change-requests and known errors and solutions are published.

On the webpage you can find informations on how the development can be supported.

2 Specification

2.1 Terminology

In order to understand this document the following chapter describes the used terms and definitions preconditioned in this specification.

business document

A business document in the sense of business transactions is an openTRANS[®]-document like an invoice or an order.

business transaction

A business transaction is the transmission of a business document between two business parties (the sender and acceptor). For example the transmission of an order done by a purchaser to the supplier is an transaction.

business process

A business process is usually a process related to a value adding task in a company. In the case of openTRANS-transactions a business process is a sequence of one, but usually more transactions. That means it is related to the exchange of more than on business document. One example is the procurement-process in the following transaction-sequence:

```
supplier <-- ORDER -- Purchaser
supplier -- ORDERRESPONSE --> Purchaser
supplier -- DISPATCHNOTIFICATION --> Purchaser
supplier <-- RECEIPTACKNOWLEDGEMENT -- Purchaser
supplier -- INVOICE --> Purchaser
supplier <-- REMITTANCEADVICE -- Purchaser
```

2.2 Structure of the specification

The documentation of the openTRANS[®] standard is made up of various documents. Each business document is described in a specification-document. The whole standard is complemented by the technical and formal specification in form of a XML-Schema document and example files.

In order to make navigation within the document easier, relevant key terms such as element names are cross-referenced, making it possible to jump directly to that part of the document in which this key term is explained in more detail. In order to make the cross-references easier to find, they are highlighted in green.

Where more detailed information on various areas is available on the Internet, this is indicated by the blue underlined hyperlinks which make it possible to jump directly to the relevant URL.

The main part of the specification is described in the **Element Library**. This Section constitutes a collection of all elements used in the related business document. In addition, an **Alphabetical Index** of the elements is to be found at the end of the specification which is intended to make it easier to find elements alphabetically sorted. This index, like the **Table of Contents**, contains cross-references which lead directly to the elements.

The appendix is divided in three modules: The index of data type describes all used data type like primitive data type but also special ones. The history of changes outlines the changes of elements in alphabetical sorting. Finally you can find two more lists of all used elements in real document-ordering and the index in alphabetical sorting.

2.3 Description of elements

Each element is described according to the same schema. The description of the elements is divided into the following points:

- **element name**,
- the **title of the element** used in the xml-documents;
- a **description** explaining the function and significance of the element;
- a **diagram** demonstrating the sub-elements and their structure;

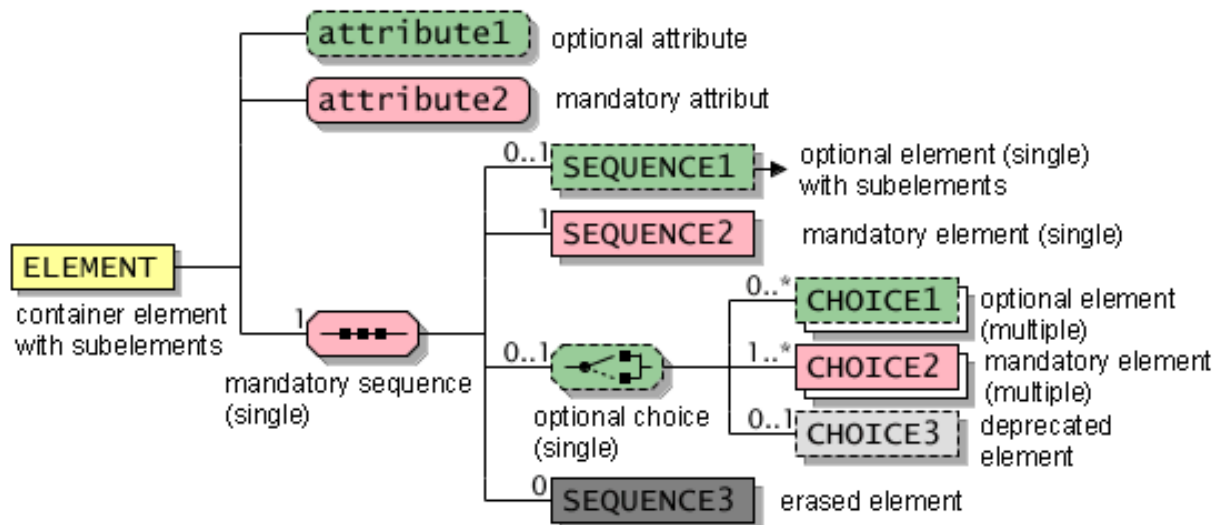

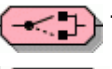
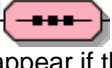

Figure 2-1: Visualization of elements and sub-elements

The element being described always appears on the left page and the subelements appear, one below the other, on the right page. Elements are shown in a rectangular box, whereas attributes are shown in a round-box. Sub-elements shown in a red color are mandatory, green respectively a bright color indicates an optional element (see also chapter "**Must**" and "**Can**" fields). Deprecated elements (which can be used but their use is not recommended) are shown with bright grey coloring. Elements which are not anymore allowed are shown in dark grey. The symbols within the elements have the following meaning:

- "**0...1**" and a dashed border indicates an optional element that can appear, but it is also possible that it will not appear at all;
 - "**1**" and a continuous border indicate that the element must appear exactly one time;
 - "**0...x**" and a dashed border indicate that the element can appear 0 up to x-times, a * instead of x indicates that number of appearances of the element is not restricted;
 - "**1...x**" and a continuous border indicate at least one appearance of the element, but it can appear up to x-times, a * instead of x indicates that number of appearances of the element is not restricted;
 - the -symbol means that the element can have at least one sub-element, if this symbol is missing the element is a leaf and a datatype must be delivered;
 - the -symbol indicates, that one of the sub-elements must appear;
 - the -symbol indicates, that the sub-elements appear in the given order (whereas they must not appear if they are optional);
- The table **General** gives a brief description of the following features of each element: the column "Used in" indicates the general elements in which the element described can be used; the column "Default value" indicates the value which will be assumed when the element has not been specified (see also Section "**Must**" and "**Can**" fields); the column "Data type" indicates – for those elements which have no sub-element – the types of data with which they can be filled; the column "Language-specific" indicates whether or not the field content can vary according to language; the column "Field length" indicates the maximum number of characters with which an element may be filled (see also **Coding in XML**); the column "Alt. in version" indicates the time of the last alteration in order to ensure a sound overview of the version alterations and additions;
 - the table **Attributes** provides a list of the attributes used in the element and describes them in the following columns: the column "Designation" contains the term which describes the attribute in, if possible, one word; the column "Attribute name" indicates the system of notation which must be used in the document; the column "Must/Can" indicates whether or not an attribute must be specified each time

an element is used or whether the use is optional (see also Section **"Must" and "Can" fields**); the column "Explanation" specifies the use of the attribute; the columns "Default value", "Data type", "Language-specific", "Field length" and "Alt. in version" are used as indicated in the table "General"; table rows colored in a bright grey indicate attributes which are deleted or deprecated in the next openTRANS[®]-version; table rows colored in dark grey are elements where the use is already restricted - they appear for the sake of completeness;

- Where a detailed specification is given of the values which an attribute may have, each attribute can be followed by a **table with a list of values**; it should be noted whether this is a list of pre-defined values (i.e. these values are suggested but other values can also be used as determined by the description of the attribute), or whether a list of permitted values is given, which means that only values from this list, and no others, may be used; the column "Attribute value" indicates the values which may or must be entered in the attribute; the columns "Explanation", "Designation" and "Alt. in version" are used as indicated in the table "Attribute";
- In the table **Elements** the sub-elements (and – where these exist – their attributes) of the elements described are listed in order and described in the following columns: the column "Element name" consists of the system of notation which must be used in the business document; where this element itself has no sub-elements, the attributes of the sub-elements are listed in this column; the columns "Designation", "Must/Can", "Default value", "Data type", "Language-specific", "Field length" and "Alt. in version" are used as indicated in the table "Attributes" or the table "General"; table rows colored in a bright grey indicate attributes which are deleted or deprecated in the next openTRANS[®]-version; table rows colored in dark grey are elements where the use is already restricted - they appear for the sake of completeness;
- An Example closes the description of elements. In the example, the openTRANS[®] elements appear in black and the variable text or selectable attribute values appear in blue.

The XML-examples demonstrate the use of openTRANS[®] with sections of a business-document. In some cases elements are not shown with their whole content but only in a schematic way like `<BUYER>...</BUYER>`

The following important symbols are used in the context of element and attribute-descriptions:



symbol	meaning
	Caution: possible source of error
	Please Note: explanatory remark with additional informations
	New since openTRANS [®] 1.0

Table 2-1: symbols in the openTRANS[®]-specification

2.4 Must- and Can-fields

The openTRANS[®] Standard distinguishes between optional and mandatory fields. Mandatory (Must) fields are XML elements which, in an openTRANS[®]-compliant XML file, must occur within the surrounding context. Optional (Can) fields are XML elements which, in an openTRANS[®]-compliant XML file may appear within their context. In figures optional fields are colored green, mandatory fields have a red color.

A business document is openTRANS[®]-compliant when it contains all Must fields and no Can fields other than those detailed in this specification in the specified order and with the specified cardinality.

For example an openTRANS[®]-**INVOICE** must have the **INVOICE_ID** in the **INVOICE_INFO**-context, whereas the **REASON_FOR_TRANSFER** in the same context is optional.

If the element **INVOICE_INFO** appears in a business document, an **INVOICE_ID**-element has to appear and can not be null or left empty, whereas the element **REASON_FOR_TRANSFER** can follow an **INVOICE_INFO**. The following examples demonstrate this issue:

Example 1 - only invoice-identification-number (Mandatory-field):

```
<INVOICE_INFO>
  <INVOICE_ID>A123</INVOICE_ID>
  . . .
```

```
</INVOICE_INFO>
```

Example 2 - not allowed: empty invoice-identification-number (Mandatory-field):

```
<INVOICE_INFO>
  <INVOICE_ID></INVOICE_ID>
  ...
</INVOICE_INFO>
```

Example 3 - invoice-identification-number (Must-field) and reason for transfer (Optional-field)

```
<INVOICE_INFO>
  <INVOICE_ID></INVOICE_ID>
  ...
  <REASON_FOR_TRANSFER>commission Meier Inc.</REASON_FOR_TRANSFER>
  ...
</INVOICE_INFO>
```

To check for elements which are required you can choose an approach from outside to inside. The following example demonstrates this. The element delivery date **DELIVERY_DATE** is optional in the context of an invoice-information **INVOICE_INFO**. If you choose to use the element **DELIVERY_DATE**, then you need to add and fill out the fields **DELIVERY_START_DATE** and **DELIVERY_END_DATE** since these elements are required if the element **DELIVERY_DATE** appears. This is straight forward as a delivery-date without mentioning the a start- and end-date is useless.

The following examples make this clear.

Example 4 - (invoice-informations without delivery date):

```
<INVOICE_INFO>
  <INVOICE_ID>...</INVOICE_ID>
  <INVOICE_DATE>...</INVOICE_DATE>
  <INVOICE_COVERAGE>...</INVOICE_COVERAGE>
  <DELIVERY_IDREF>...</DELIVERY_IDREF>
  <INVOICE_ISSUER_IDREF>...</INVOICE_ISSUER_IDREF>
  <INVOICE_RECIPIENT_IDREF>...</INVOICE_RECIPIENT_IDREF>
  <PARTIES>...</PARTIES>
  <CURRENCY>...</CURRENCY>
</INVOICE_INFO>
```

Example 5 - (invoice-informations including delivery date):

```
<HEADER>
  <INVOICE_ID>...</INVOICE_ID>
  <INVOICE_DATE>...</INVOICE_DATE>
  <INVOICE_COVERAGE>...</INVOICE_COVERAGE>
  <!-- hier kann DELIVERY_DATE angegeben werden (Kann-Feld) -->
  <DELIVERY_DATE>
    <!-- hier muss DELIVERY_START_DATE angegeben werden (Muss-Feld) -->
    <DELIVERY_START_DATE>2008-01-01</DELIVERY_START_DATE>
    <!-- hier muss DELIVERY_END_DATE angegeben werden (Muss-Feld) -->
    <DELIVERY_END_DATE>2008-03-31</DELIVERY_END_DATE>
  </DELIVERY_DATE>
  <DELIVERY_IDREF>...</DELIVERY_IDREF>
  <INVOICE_ISSUER_IDREF>...</INVOICE_ISSUER_IDREF>
  <INVOICE_RECIPIENT_IDREF>...</INVOICE_RECIPIENT_IDREF>
  <PARTIES>...</PARTIES>
  <CURRENCY>...</CURRENCY>
</HEADER>
```

2.5 Data types

Data types specify the value format and range of all the elements used in a document. Each atomic element is assigned one data type. The use of data types permits the semantics of document elements to be specified precisely. This is a basic precondition for importing or exporting documents. External systems which generate or process documents then recognize the format in which a particular document expects values to be entered and can recognize the format in which they are saved. The openTRANS[®] Standard distinguishes between basic, scalar and enumerated data types.

The **basic data type** define common used field-formats like strings, integers, boolean values (true or false) etc. A **table of basic data type** can be found in the appendix.

Additionally many **enumerated data type** based on international standards are used within the specification. An enumerated datatype is a set of permitted string-values. An element with an enumerated datatype can only reflect a value of its assigned set. All enumerated data type are shown in the **table of enumerated data**

type.

The **table of special data type** describes **special data type** with particular functions. These types are empty defined and usually don't have to be considered by the user as long as no user-defined module-extensions are integrated in the document. In the case of extensions these data type are to be redefined and concretized.

2.6 Coding in XML

The coding of individual characters in the XML elements should be specified in each openTRANS[®] file. This is done in the attribute "encoding" of the XML text declaration as in `<?xml version="1.0" encoding="UTF-8" ?>` Here "UTF-8" is specified as a character set.

openTRANS[®] supports all the character sets which appear in the XML specification (for example, ISO-8859-1, UTF-8, UTF-16). Within UTF character sets, a character is normally stored in one or more bytes. It should be noted that the field lengths in the field length column relate to the individual characters and not to the number of bytes used in a character set. For example, the code "Ü" which represents the letter "Ü", constitutes only one character. See also **chapter: multilanguage documents**.

2.7 History of openTRANS versions

Version	Date	Description
2005	04.11.2005	BMEcat [®] 2005: Implementation of Feedback for BMEcat 2005 version
20v1	26.02.2008	openTRANS [®] Release: first solution concepts prior to the development workshops
20v2	04.07.2008	openTRANS [®] Release: Implementation of feedback of the 1. workshop
20v3	31.07.2008	openTRANS [®] Release: Implementation of feedback of the 2. workshop
20fd	28.08.2008	openTRANS [®] 2.0 final draft: Revision, extension and implementation of the workshop-developments; Redesign of the specification
20	22.10.2008	openTRANS [®] 2.0: Implementation of feedback from the public draft phase
21fd	01.07.2009	openTRANS [®] 2.1 final draft: Implementation of feedback since publication of the final version 2.0. Bugfixes and example-adaptions.
21	02.10.2009	openTRANS [®] 2.1: Implementation of feedback since publication of the 2.1 final draft. Bugfixes and example-adaptions. Changes are mainly related to the INVOICELIST document.

Table 2-1: History of openTRANS[®] versions

3 Dataexchange with openTRANS 2.x

3.1 document structure

With openTRANS[®] it is possible to implement data about the business document itself and about data related to items in the document. openTRANS[®] 2.1-documents therefore consist of three logical areas - header, item-list and summary. This structure is tested since version 1.0 and is shortly present here.

3.1.1 Header-Level

The header (e.g. INVOICE_HEADER) describes all general information which is related to the whole document. This includes e.g. addresses of the parties and contract-informations. The header is similar for all openTRANS[®] 2.1 documents.

3.1.2 Item-Level

The item-level shows the relevant information for products, order-contents, position for supply or invoices in an invoice-list-document. Additionally values which are set on default on header-level often can be overwritten on item-level.

3.1.3 Summary

The summary is the closing of each document. Here you can find redundant information which is aggregated of the values on item-level. With the help of the summary you can do rechecks and sometimes (like for invoices) this area is required by law.

3.2 Multilingual documents



In openTRANS[®] all documents are defined in one language. Since the similarity of the used sub-elements in BMEcat[®] 2005 and openTRANS[®] 2.1 the formal definition of the XML-files permits multilingual documents. That means the corresponding XML-Schema may declares elements as "multiple" whereas the specification declares them as "single". In those cases the elements are allowed to be used more than one time only if more than one language is implemented in the same document/XML-file. In this case one can use them once per language. We implemented this to provide the opportunity to generally support multilingual files, although this is explicitly not provided by the standard and should be arranged between the partners. That means if multilingual documents are used this should be discussed and synchronized with the exchange-parties. A description of how multilingual documents can be used is shown on <http://www.bmecat.org> in the BMEcat documentation.

3.3 Changes in openTRANS 2.0

Beside numerous detail-improvements we implemented many new general requirements in openTRANS[®] 2.0. Here you can find the most significant changes and extensions:

- revision of invoice for new requirements by law
- support of processes with electronic signature
- extension of picemodels, especially multilevel surcharges and discounts
- better support for scenarios including intermediates, e.g. on marketplaces or with central regulators
- extend of the productmodel to better represent features and components (product configurations)
- two new business documents, INVOICELIST and REMITTANCEADVICE
- basic compatibility to BMEcat[®] 2005 (same definition for fields in both standards)

3.4 Changes in openTRANS[®] 2.1

In openTRANS[®] 2.1 many suggestions were implemented which reached us since publication of the final version 2.0. Main changes are related to bug fixes and example-adaptions. No large structural changes were made.

3.5 Downward compatibility zu openTRANS 1.0

openTRANS[®] 2.1 is not downward compatible to openTRANS[®] 1.0 but similar in the structure. Most elements of version 1.0 are reused in version 2.1. Some of them now have new sub-elements or new definitions. It should not be too complex to adapt software-systems or to create converters for 1.0-2.1 conversion.

3.6 Compatibility with BMEcat[®]

openTRANS[®] 2.1 business documents are compatible to BMEcat[®] 2005 catalogs meaning identical element(-definitions), rules and structures. This simplifies the usage of the data and software-systems using both standards.

Due to the asynchronous development-cycles of both standards we have some exceptions of differences of element-structures (like in **PARTY**). In this case we anticipated some future changes coming in the next BMEcat[®] version.

Reference of elements - order by appearance

ORDER

(Order)

Every valid ORDER business document in openTRANS® format is triggered by the root element ORDER and consists of a header (ORDER_HEADER), an item level (ORDER_ITEM_LIST) and a summary (ORDER_SUMMARY).

The header is at the beginning of the business document and contains global data valid for all types of business data exchange such as, for example information on suppliers or information on skeleton agreements which may exist between the buyer and the supplier. The header also lays down default settings for the following item level.

The item level contains the individual positions in the order. Here the information is transferred from the header on the item level provided the item level has not been overwritten. This principle is valid for all elements with the exception of the element PARTIAL_SHIPMENT_ALLOWED. Where this element is used in the header, it may not be used at item level.

The summary contains a summary of the information on the order. The information in this element is redundant and can be used for control and statistical evaluation.

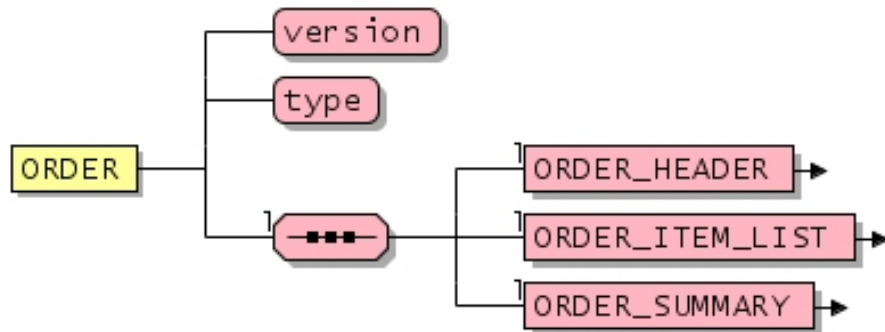

General

Used in	Default value	Data type	Field length	Lang. specific	l.chg. in ver.
-	-	-	-	-	2.0

Attributes

Designation	Attribute name	Mandatory/optional	Explanation	Default value	Data type	Field length	Lang. specific	l.chg. in ver.
Version	version	Mandatory	Indicates the version of the openTRANS® Standard to which the business document corresponds. Value range: "Major Version"."Minor Version" (Example: "1.0") See also: Permitted values for attribute "version"	-	dtSTRING	7	-	2.0
Type of order	type	Mandatory	Specifies the type of order. See also: Permitted values for attribute "type"	-	dtSTRING	20	-	2.0

Permitted values for attribute "version"

Designation	Attribute value	Explanation	I.chg. in ver.
	2.1		-

Permitted values for attribute "type"

Designation	Attribute value	Explanation	I.chg. in ver.
Standard delivery	standard	Standard delivery is requested.	-
Express delivery	express	Express delivery is requested.	-
Call-forward notice	release	The order is a call-forward notice from a skeleton agreement. The skeleton agreement is specified under AGREEMENT.	-
release order from a consignment	consignment	Specifies the removal of an article from consignment stock (supplier's stocks at customers)	-

Elements

Designation	Element name	Mandatory/Optional	Single/Multiple	Explanation	Default value	Data type	Field length	Lang. specific	I.chg. in ver.
Header level	ORDER_HEADER	Mandatory	Single	The header level is used to transfer information about business partners and the business document and enter default settings which can be overwritten on item level.	-	-	-	-	2.0
Item level	ORDER_ITEM_LIST	Mandatory	Single	The item level lists the individual positions of the order.	-	-	-	-	2.0
Summary	ORDER_SUMMARY	Mandatory	Single	Summary of the order information. The information in this element is redundant.	-	-	-	-	2.0

ORDER_HEADER

(Header level)

The header is specified by the ORDER_HEADER element. ORDER_HEADER is used to transfer information about the business partners and the business document and enter default settings which can basically be overwritten on item level (ORDER_ITEM).

⚠ The exception for overwriting at the level (ORDER_ITEM) is the element PARTIAL_SHIPMENT_ALLOWED. In this case, the value in the header overwrites the value at the item level (ORDER_ITEM).

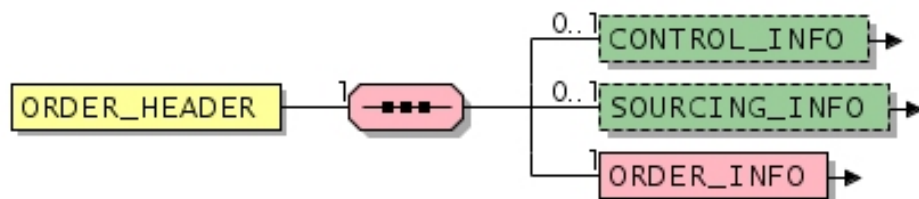

General

Used in	Default value	Data type	Field length	Lang. specific	I.chg. in ver.
ORDER	-	-	-	-	2.0

Elements

Designation	Element name	Mandatory/Optional	Single/Multiple	Explanation	Default value	Data type	Field length	Lang. specific	I.chg. in ver.
Control information	CONTROL_INFO	Optional	Single	Control information for the automatic processing of the business documents	-	-	-	-	-
Sourcing information	SOURCING_INFO	Optional	Single	Information about previous quotations, catalog references, skeleton agreements.	-	-	-	-	2.0
Buyer information	ORDER_INFO	Mandatory	Single	Order information on this business document. ⚠*	-	-	-	-	20

CONTROL_INFO

(Control information)

Control information for the automatic processing of the business document is stored in the element **CONTROL_INFO**.

If the element **CONTROL_INFO** is used, at least one of the following elements must be included.

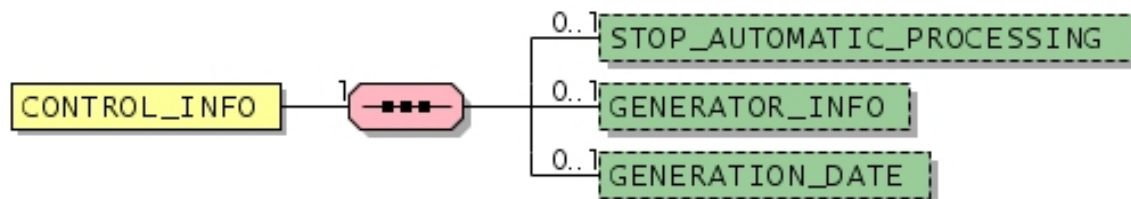

General

Used in	Default value	Data type	Field length	Lang. specific	l.chg. in ver.
ORDER_HEADER	-	-	-	-	-

Elements

Designation	Element name	Mandatory/Optional	Single/Multiple	Explanation	Default value	Data type	Field length	Lang. specific	l.chg. in ver.
Interruption of automatic processing in the target system	STOP_AUTOMATIC_PROCESSING	Optional	Single	An instruction for the target system can be stored here if manual processing of the business document is required. The element consists of a text explaining why manual processing is necessary. Automatic processing in the target system is interrupted if the element is not empty. Caution: the element should only be used in justified exceptional cases (e.g. "Import test – NO processing is necessary")!	-	dtSTRING	250	-	2.0_fd
Generator information	GENERATOR_INFO	Optional	Single	Information about the generator (manual or automatic) of the document	-	dtSTRING	250	-	-
Generation date of the business document	GENERATION_DATE	Optional	Single	Generation date of the XML-document.	-	dtDATE-TIME	-	-	2.0_fd

SOURCING_INFO

(Sourcing information)

The element SOURCING_INFO summarizes information about acquisition activities which have preceded this order. If the element SOURCING_INFO is used, at least one of the following elements has to be given.

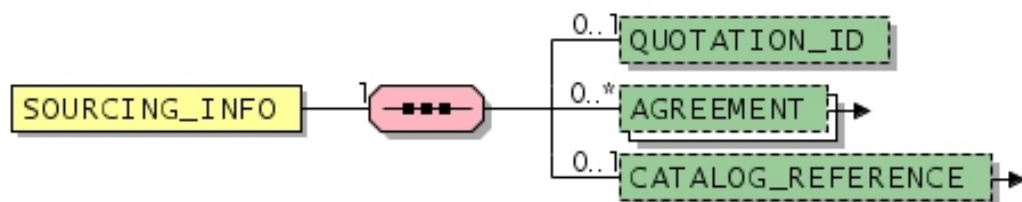

General

Used in	Default value	Data type	Field length	Lang. specific	l.chg. in ver.
ORDER_HEADER, ORDER_ITEM	-	-	-	-	2.0

Elements

Designation	Element name	Mandatory/Optional	Single/Multiple	Explanation	Default value	Data type	Field length	Lang. specific	l.chg. in ver.
Supplier quotation number	QUOTATION_ID	Optional	Single	Unique quotation number allocated by the supplier.	-	dtSTRING	250	-	2.0
Reference to a skeleton agreement	AGREEMENT - type - default	Optional	Multiple	Information on the skeleton agreement which serves as a basis for the validity of the business document 	-	-	-	-	2005fd
Reference to an (electronic) product catalog	CATALOG_REFERENCE	Optional	Single	Order reference to a catalog. This element can also be used as a reference to a price list.	-	-	-	-	2.0

AGREEMENT

(Reference to a skeleton agreement)

This element serves for referring to a skeleton agreement, which is relevant for the business document. Agreements which cannot be transported in the business document itself are regulated in this skeleton agreement.



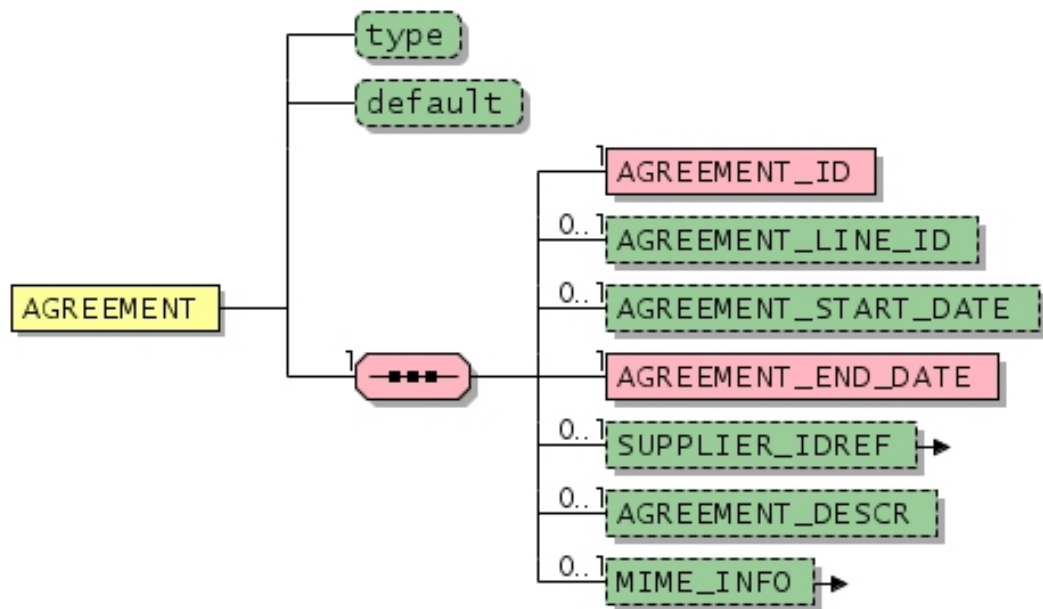

The element was revised and the following sub-elements were added: **AGREEMENT_LINE_ID**, **AGREEMENT_START_DATE**, **AGREEMENT_END_DATE**, **SUPPLIER_IDREF**, **AGREEMENT_DESCR**, **MIME_INFO**



General

Used in	Default value	Data type	Field length	Lang. specific	l.chg. in ver.
SOURCING_INFO	-	-	-	-	2005fd

Attributes

Designation	Attribute name	Mandatory/ optional	Explanation	Default value	Data type	Field length	Lang. specific	l.chg. in ver.
Agreement type	type	Optional	<p>Owner of the skeleton agreement.</p> <p>If reference is made to skeleton agreements of an intermediary, the element value should point to the intermediary.</p> <p>Some target systems are not in a position to interpret other values than the pre-defined ones.</p> <p> New attribute</p> <p>See also: Predefined values for attribute "type"</p>	-	dtSTRING	50	-	2005fd
Default flag	default	Optional	<p>This attribute marks a standard agreement.</p> <p> New attribute</p>	-	dtBOO- LEAN	-	-	2005fd





Predefined values for attribute "type"

Designation	Attribute value	Explanation	l.chg. in ver.
Buyer	buyer	Marking for a buyer's skeleton agreement.	2005fd
Supplier	supplier	Marking for a supplier's skeleton agreement.	2005fd
User defined marking	User defined value, format: \w{1,50}	User defined marking. "\w{1,50}" means that the marking has to be at least 1 character long up to a maximum of 50 characters.	2005fd

Elements

Designation	Element name	Mandatory/ Optional	Single/ Multiple	Explanation	Default value	Data type	Field length	Lang. specific	l.chg. in ver.
Skeleton agreement ID	AGREEMENT_ID	Mandatory	Single	<p>Unique identifier of the skeleton agreement.</p> <p>The element can also be used for special agreement information, e.g. special project-related agreements.</p> <p><i>namespace: BMECAT</i></p>	-	dtSTRING	50	-	-
Line number within the skeleton agreement	AGREEMENT_LINE_ID	Optional	Single	<p>Unique line number within a skeleton agreement.</p> <p>This element allows a unique reference to a line of a skeleton agreement.</p> <p><i>namespace: BMECAT</i></p> <p> New element</p>	-	dtSTRING	50	-	2005fd

Elements

Designation	Element name	Mandatory/Optional	Single/Multiple	Explanation	Default value	Data type	Field length	Lang. specific	l.chg. in ver.
Start date of the skeleton agreement	AGREEMENT_START_DATE	Optional	Single	Unique time stamp of the time, when the skeleton agreement begins. <i>namespace: BMECAT</i>  This element replaces with a modified semantics the former DATETIME element and its type='agreement_start_date' attribute.	-	dt DATETIME	-	-	2005fd
End date of the skeleton agreement	AGREEMENT_END_DATE	Mandatory	Single	Unique time stamp for the time when the skeleton agreement ends. <i>namespace: BMECAT</i>  This element replaces with a modified semantics the former DATETIME element and its type='agreement_end_date' attribute.	-	dt DATETIME	-	-	2005fd
Reference to supplier	SUPPLIER_IDREF - type	Optional	Single	Reference to the supplier. It contains the unique identifier (PARTY_ID) of the respective party that is defined in the document (element PARTY). <i>namespace: BMECAT</i> 	-	dt STRING	250	-	2005fd
Description of the skeleton agreement	AGREEMENT_DESCR	Optional	Single	This element is used to describe the skeleton agreement.  New element	-	dt ML-STRING	250	Yes	2005fd
Additional multimedia information	MIME_INFO	Optional	Single	Information about multimedia files For instance the skeleton agreement of the document could be added.	-	-	-	-	-

Example

```
<AGREEMENT type="buyer">
  <bmeecat:AGREEMENT_ID>1003552/2005</bmeecat:AGREEMENT_ID>
  <bmeecat:AGREEMENT_LINE_ID>2</bmeecat:AGREEMENT_LINE_ID>
  <bmeecat:AGREEMENT_START_DATE>2005-01-01</bmeecat:AGREEMENT_START_DATE>
  <bmeecat:AGREEMENT_END_DATE>2005-12-31</bmeecat:AGREEMENT_END_DATE>
  <AGREEMENT_DESC>Office Supplies</AGREEMENT_DESC>
</AGREEMENT>
```

SUPPLIER_IDREF

(Reference to supplier) *namespace: BMECAT*

This element contains the unique identifier (**PARTY_ID**) of the respective party that is defined in the document (element **PARTY**).



This new element together with the **PARTY** replaces the **SUPPLIER** element.

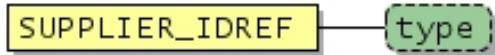

General

Used in	Default value	Data type	Field length	Lang. specific	l.chg. in ver.
AGREEMENT, ORDER_PARTIES_REFERENCE, PRODUCT_ID	-	dtSTRING	250	-	2005fd

Attributes

Designation	Attribute name	Mandatory/optional	Explanation	Default value	Data type	Field length	Lang. specific	l.chg. in ver.
Coding standard	type	Optional	This attribute is used to state the coding standard to which the identifier (PARTY_ID) adheres. The most common coding standards are predefined. See also: Predefined values for attribute "type"	-	dtSTRING	250	-	1.2_fd

Predefined values for attribute "type"

Designation	Attribute value	Explanation	l.chg. in ver.
Buyer-specific number	buyer_specific	Identification number defined by the buyer	-
Customer specific number	customer_specific	Identification number defined by the customer	2005fd
Dun & Bradstreet	duns	DUNS-Number (see also http://dbuk.dnb.com/english/DataBase/duns.htm)	-
Global location number	iln	Internationally called GLN (see GLN below)	-
Global location number	gln	Global Location Number GLN (see also http://www.ean-int.org/locations.html)	2005fd
Party-specific number	party_specific	Identification number defined by the respective party	2005fd
Supplier-specific number	supplier_specific	Identification number defined by the supplier	-
Other codification standard	User defined value, format: \w{1,250}	Identificator of codification standard. "\w{1,250}" means that the identificator of the codification standard has to be at least 1 character long up to a maximum of 250 characters.	-

MIME_INFO

(Additional multimedia information)

This element can be used to specify references to additional multimedia documents belonging to a particular article. This makes it possible, for example, to reference photographs or product data sheets of an article at the same time as the catalog data is exchanged.

It is assumed that this additional data either is transferred (separately) and that it is imported relative to the directory specified in the **HEADER** as **MIME_ROOT** or the additional data is directly integrated and binary-coded in the document.

This element can contain any number of **MIME** elements. Each of these elements represents exactly one reference to an additional document. The definition of the **MIME** element is based on the MIME format (Multipurpose Internet Mail Extensions). The MIME format serves to standardize data transfers over the Internet. Additional examples can be found on the page describing the element **MIME**.

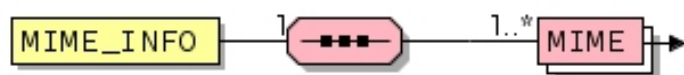

General

Used in	Default value	Data type	Field length	Lang. specific	l.chg. in ver.
AGREEMENT, FEATURE_CONTENT, FT_VALUE, ORDER_INFO, ORDER_ITEM, PARTY	-	-	-	-	-

Elements

Designation	Element name	Mandatory/Optional	Single/Multiple	Explanation	Default value	Data type	Field length	Lang. specific	l.chg. in ver.
Multimedia document	MIME	Mandatory	Multiple	Information about a multimedia file. The file itself is can be referenced and transferred separately or directly binary-coded in the document via the element MIME_EMBEDDED . *	-	-	-	-	21fd

Example

```
<MIME_INFO>
  <MIME>
    <bmeecat:MIME_TYPE>image/jpeg</bmeecat:MIME_TYPE>
    <bmeecat:MIME_SOURCE>55-K-31.jpg</bmeecat:MIME_SOURCE>
    <bmeecat:MIME_DESCR>Frontal view of the standard DIN A4 letter tray</bmeecat:MIME_DESCR>
    <bmeecat:MIME_ALT>Image of the standard DIN A4 letter tray</bmeecat:MIME_ALT>
    <MIME_PURPOSE>thumbnail</MIME_PURPOSE>
  </MIME>
  <MIME>
    <MIME_EMBEDDED>
      <MIME_DATA contentType="image/jpeg">bnVyIGVpbiBUZXN0bGF1Zg==</MIME_DATA>
    </MIME_EMBEDDED>
    <bmeecat:MIME_DESCR>Vorderansicht</bmeecat:MIME_DESCR>
    <bmeecat:MIME_ALT>Bild Charlie</bmeecat:MIME_ALT>
    <MIME_PURPOSE>freehand_sketch</MIME_PURPOSE>
  </MIME>
</MIME_INFO>
```

MIME

(Multimedia document)

Information about a multimedia file. The file itself is can be referenced and transferred separately or directly binary-coded in the document via the element **MIME_EMBEDDED**.





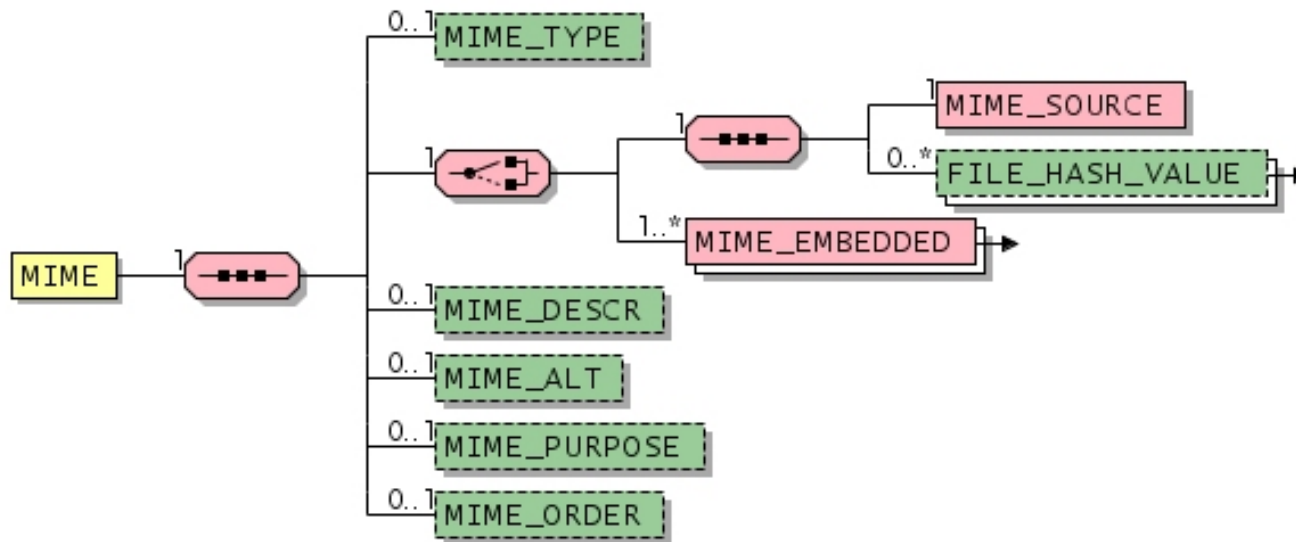

The element **MIME_EMBEDDED** was added.
Examples adapted.



General

Used in	Default value	Data type	Field length	Lang. specific	l.chg. in ver.
MIME_INFO	-	-	-	-	21fd

Elements

Designation	Element name	Mandatory/Optional	Single/Multiple	Explanation	Default value	Data type	Field length	Lang. specific	l.chg. in ver.
MIME type	MIME_TYPE	Optional	Single	Type of the additional document; this element is oriented towards the mime type usual in the Internet (ftp://ftp.isi.edu/in-notes/rfc1341.txt) <i>namespace: BMECAT</i>  The element is now mandatory. The recipient can now better process the incoming data since the format is always known. See also: Predefined values for element MIME_TYPE	-	dtSTRING	30	-	21fd
Source	MIME_SOURCE	Mandatory	Single	The relative path and the file name or URL address. The MIME_SOURCE string is combined with the base path (MIME_ROOT) specified in the header of the document (attached to it by means of a simple concatenation). Sub-directories must be separated by means of slashes ("/") (e.g. /public/document/demo.pdf). <i>namespace: BMECAT</i>	-	dtML-STRING	255	Yes	-
Hash value of a file	FILE_HASH_VALUE - type - lang	Optional	Multiple	Element contains a hash value related to an external file 	-	dtSTRING	100	-	21fd
Embedded document	MIME_EMBEDDED - lang	Mandatory	Multiple	Element containing a binary-coded file and additional information 	-	-	-	-	20v2
Designation	MIME_DESCR	Optional	Single	Description of the additional file. It will be displayed in the target system. <i>namespace: BMECAT</i>	-	dtML-STRING	250	Yes	-
Alternative text	MIME_ALT	Optional	Single	Alternative text used if the file cannot be represented in the target system, for example. <i>namespace: BMECAT</i>  The maximum length has been extended from 50 characters to 80 characters.	-	dtML-STRING	80	Yes	2005fd









Elements

Designation	Element name	Mandatory/Optional	Single/Multiple	Explanation	Default value	Data type	Field length	Lang. specific	l.chg. in ver.
Purpose	MIME_PURPOSE	Optional	Single	<p>Desired purpose for which the MIME document is to be used in the target system.</p> <p></p> <p>The list of allowed values has been extended by 'icon' and 'safety_data_sheet'. The list of allowed values has been extended by 'manual' (manual of a product), 'directions' (directions sketch), 'conformity' (declaration of conformity), 'fax_image' (copy of a fax), 'freehand_sketch' (freehand sketch), 'mounting_guidelines' (assembly guide or installation guide etc.), 'repair_manual' (repair instructions), 'service_descr' (service description), 'service_record' (activity confirmation, record of achievement etc.) and 'warranty' (warranty). The list of allowed values has been extended by 'verification_report' (Report of verification process). The list of allowed values has been extended by 'signatur_file' (file with an external signature) and 'original_document' (the original document). See also: Permitted values for element MIME_PURPOSE</p>	-	dtSTRING	20	-	20v3
Order	MIME_ORDER	Optional	Single	<p>Order in which the additional data is to be represented in the target system. When additional documents are listed they should be represented in ascending order (the first document is the one with the lowest number). <i>namespace: BMECAT</i></p>	-	dtINTEGER	-	-	-







Predefined values for element MIME_TYPE

Designation	Element value	Explanation	l.chg. in ver.
PDF document	application/pdf	(Local) Acrobat PDF format	-
XML file	application/xml	(Local) XML file (see also http://www.w3.org/TR/xhtml-media-types/xhtml-media-types.html)	2005fd
GIF	image/gif	(Local) image/graphic in GIF format	-
JPEG	image/jpeg	(Local) image/graphic in JPEG format	-
HTML	text/html	(Local) document in HTML format (within the catalog file system; see also http://www.w3.org/TR/xhtml-media-types/xhtml-media-types.html)	-
Text	text/plain	(Local) unformatted text file	-
URL	url	Link to a resource on the Internet (or Intranet); this is not an official MIME type but will be used here anyway. Example: "http://www.bmecat.org"	-
...	User defined value, format: [w\-.]{1,30}	All MIME types can be used. It cannot be guaranteed, however, that the target systems will be able to represent them.	-

Permitted values for element MIME_PURPOSE

Designation	Element value	Explanation	l.chg. in ver.
Declaration of conformity	conformity	Declaration of conformity to confirm the conform usage of norms and standards  New value	20v2
Product data sheet	data_sheet	Product data sheet (e.g. a technical drawing)	-
Detail view	detail	Enlarged image	-
Directions sketch	directions	Directions sketch, map of building or city map  New value	20v2
Copy of a fax	fax_image	Electronic copy of the original  New value	20v2
Freehand sketch	freehand_sketch	Freehand sketch of something (product etc.)  New value	20v2
Icon	icon	Small icon, e.g to indicate the fulfillment of a standard  New value	2005fd
Logo	logo	Product or partner logo	1.2_fd
Manual	manual	Manual of the product  New value	20v2
Mounting guide	mounting_guidelines	Mounting, assembly or installation guide  New value	20v2
Normal view	normal	Normal view (normal size)	-
Original document	original_document	Representation of the document in human readable form (e.g. as PDF-file or graphic)  New value	20fd

Permitted values for element MIME_PURPOSE

Designation	Element value	Explanation	l.chg. in ver.
Repair instructions	repair_manual	Repair instructions for a product  New value	20v2
Safety data sheet	safety_data_sheet	Safety data sheet (for dangerous materials, for example)  New value	2005fd
Signatur file	signatur_file	File containing an external signatur  New value	20fd
Service description	service_descr	Description of the offered service or produkt  New value	20v2
Service record	service_record	Record of the activity, performance, achievement or a copy of the original  New value	20v2
Thumbnail view	thumbnail	Preview (small)	-
Report of verification	verification_report	Report of verification or test-processes  New value	20v3
Warranty	warranty	Warranty certificate  New value	20v2
Others	others	Should none of the other values be suitable, others can be used.	-

Example 1
References to an image file and a product data sheet belonging to the “Charlie casual shirt” must be transferred at the same time as the product data is being exchanged.

```
<MIME_INFO>
  <MIME>
    <bmeecat:MIME_TYPE>image/jpeg</bmeecat:MIME_TYPE>
    <bmeecat:MIME_SOURCE>charlie.jpg</bmeecat:MIME_SOURCE>
    <FILE_HASH_VALUE type="sha1">9bae0ce526a7b30275ac0d3bdfe3c90e41def6ed</FILE_HASH_VALUE>
    <bmeecat:MIME_DESCR>Front view of our casual shirt</bmeecat:MIME_DESCR>
    <bmeecat:MIME_ALT>Photo of Charlie</bmeecat:MIME_ALT>
    <MIME_PURPOSE>normal</MIME_PURPOSE>
  </MIME>
  <MIME>
    <bmeecat:MIME_TYPE>application/pdf</bmeecat:MIME_TYPE>
    <bmeecat:MIME_SOURCE>charlie.pdf</bmeecat:MIME_SOURCE>
    <FILE_HASH_VALUE type="sha1">72506ebaf7df4b02e79284ae86684327c908fec6</FILE_HASH_VALUE>
    <bmeecat:MIME_DESCR>Designation of the production process</bmeecat:MIME_DESCR>
    <bmeecat:MIME_ALT>PDF file belonging to Charlie</bmeecat:MIME_ALT>
    <MIME_PURPOSE>data_sheet</MIME_PURPOSE>
  </MIME>
</MIME_INFO>
```

Example 2
An image file belonging to the “Charlie casual shirt” is transferred directly in the document.

```
<MIME_INFO>
  <MIME>
    <bmeecat:MIME_SOURCE>charlie.jpg</bmeecat:MIME_SOURCE>
    <MIME_EMBEDDED>
      <MIME_DATA contentType="image/jpeg">bnVyIGVpbiBUZXN0bGF1Zg==</MIME_DATA>
    </MIME_EMBEDDED>
    <bmeecat:MIME_DESCR>Front view of our casual shirt</bmeecat:MIME_DESCR>
    <bmeecat:MIME_ALT>Photo of Charlie</bmeecat:MIME_ALT>
    <MIME_PURPOSE>normal</MIME_PURPOSE>
  </MIME>
</MIME_INFO>
```

FILE_HASH_VALUE

(Hash value of a file)

The element contains a hash value to an external referred file. The hash value can be used to check if the file was changed since the last generation of the hash value. Generally hash values serve as input for data comparison tasks.



This element can only be used once per language in a document.



New element

A list of available values was added. Example added.

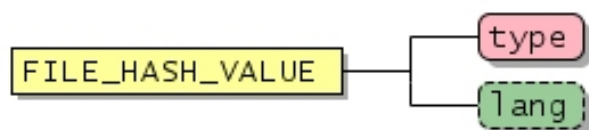

General

Used in	Default value	Data type	Field length	Lang. specific	l.chg. in ver.
MIME	-	dtSTRING	100	-	21fd

Attributes

Designation	Attribute name	Mandatory/optional	Explanation	Default value	Data type	Field length	Lang. specific	l.chg. in ver.
Methods of Hashing	type	Mandatory	The attribute indicates the used hash-function. In germany the BNetzA or BSI guidelines are fundamental for legal certainty, therefore the used hash-function should match the guidelines. New attribute See also: Predefined values for attribute "type"	-	dtSTRING	50	-	20fd
Language version of the file	lang	Optional	The attribute "lang" indicates the language of the referenced file in MIME_SOURCE . New attribute	-	dtLANG	-	-	20fd

Predefined values for attribute "type"

Designation	Attribute value	Explanation	l.chg. in ver.
SHA512	SHA512	SHA-512 Hash-function.	21fd
SHA384	SHA384	SHA-384 Hash-function.	21fd
SHA256	SHA256	SHA-256 Hash-function.	21fd
SHA1	SHA1	SHA-1 Hash-function.	21fd
MD5	MD5	MD5 Hash-function.	21fd
RIPMD128	RIPMD128	RIPMD-128 Hash-function.	21fd
RIPMD160	RIPMD160	RIPMD-160 Hash-function.	21fd
RIPMD256	RIPMD256	RIPMD-256 Hash-function.	21fd
RIPMD320	RIPMD320	RIPMD-320 Hash-function.	21fd
Tiger192	Tiger192	Tiger-192 Hash-function.	21fd
Tiger160	Tiger160	Tiger-160 Hash-function.	21fd
Tiger128	Tiger128	Tiger-128 Hash-function.	21fd
HAVAL	HAVAL	HAVAL Hash-function.	21fd
PANAMA	PANAMA	PANAMA Hash-function.	21fd
WHIRLPOOL	WHIRLPOOL	WHIRLPOOL Hash-function.	21fd
LM-Hash	LMHash	LM-Hash-function.	21fd
NTLM	NTLM	NTLM Hash-function.	21fd
Userdefined type	User defined value, format: \w{1,50}	Any other or future Hash-function in format \w{1,50}. Regular Expression valid for any letter or number excluding whitespaces.	21fd

Example

```
<FILE_HASH_VALUE type="MD5">54fec8f377b45af5d6c78974g88ba98</FILE_HASH_VALUE>
```

MIME_EMBEDDED

(Embedded document)

The element consists of a sub-element for the transmission of a file and sub-elements containing additional information (e.g. file name).



The element can only be used once per language, for example if three languages are implemented in the document this element can be used three times.



New element

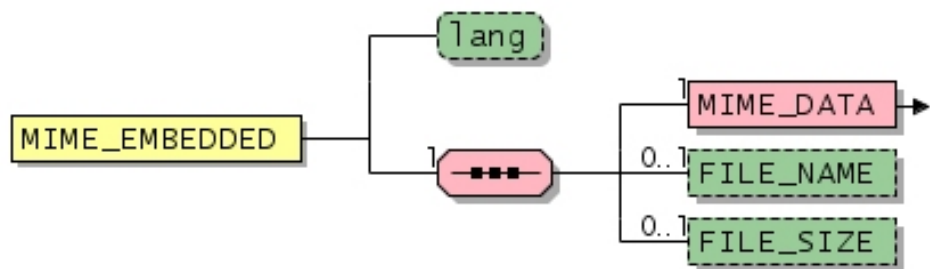



General

Used in	Default value	Data type	Field length	Lang. specific	l.chg. in ver.
MIME	-	-	-	-	20v2

Attributes

Designation	Attribute name	Mandatory/optional	Explanation	Default value	Data type	Field length	Lang. specific	l.chg. in ver.
Language version of the file	lang	Optional	The attribute "lang" specifies the language of the embedded file. The encoding of the attribute value follows the corresponding data type dtLANG . This enables the implementation of more than one language in one document (see also Chapter: multilingual documents). In case of specifying more than one single-declared element to support a multilingual document all "lang"-attributes must contain different values (one unique value per language).  New attribute	-	dtLANG	-	-	20v2

Elements

Designation	Element name	Mandatory/ Optional	Single/ Multiple	Explanation	Default value	Data type	Field length	Lang. specific	l.chg. in ver.
Coded data of the file	MIME_DATA - contentType	Mandatory	Single	Element contains binary-coded file 	-	base64Binary	-	-	20v2
Filename	FILE_NAME	Optional	Single	Name of the file  New element	-	dtSTRING	250	-	20v2
Filesize	FILE_SIZE	Optional	Single	Size of the File in Byte  New element	-	dtCOUNT	-	-	20v2

MIME_DATA

(Coded data of the file)

The element contains a binary-coded file, therefore the file is not referenced but included in the XML-document. The coded file must be generated using the 'base64' binary-to-text encoding scheme. See also <http://www.ietf.org/rfc/rfc2045.txt> for further details related to the base64 encoding scheme. For further details on how to embed files in XML-files visit <http://www.w3.org/TR/xml-media-types/>.



New element



General

Used in	Default value	Data type	Field length	Lang. specific	l.chg. in ver.
MIME_EMBEDDED	-	base64Binary	-	-	20v3

Attributes

Designation	Attribute name	Mandatory/optional	Explanation	Default value	Data type	Field length	Lang. specific	l.chg. in ver.
File type	contentType	Optional	The attribute specifies the type of the embedded document according to the common used MIME-Ty-pes in the world wide web (ftp://ftp.isi.edu/in-notes/rfc1341.txt). The attribute is equivalent to the element MIME_TYPE but should be specified to ensure a better compatibility to the w3c-recommendation (http://www.w3.org/TR/xml-media-types/).  New attribute	-	string	-	-	20v2

CATALOG_REFERENCE

(Reference to an (electronic) product catalog)

In the CATALOG_REFERENCE element reference is made to an (electronic) product catalog which serves as a quotation for the order. This element can also be used as a reference to a price list.

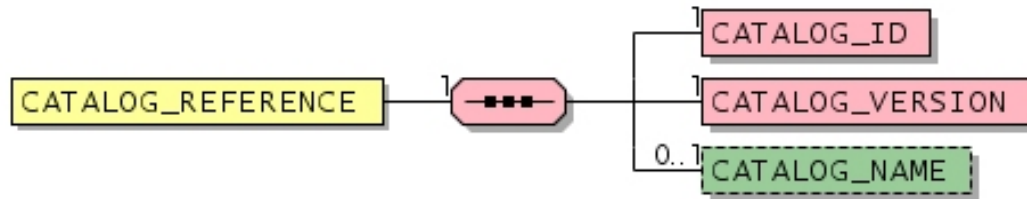

General					
Used in	Default value	Data type	Field length	Lang. specific	l.chg. in ver.
SOURCING_INFO	-	-	-	-	2.0

Elements									
Designation	Element name	Mandatory/Optional	Single/Multiple	Explanation	Default value	Data type	Field length	Lang. specific	l.chg. in ver.
Catalog ID	CATALOG_ID	Mandatory	Single	Unique catalog identification. This ID is usually assigned by the supplier when the catalog is generated and remains unchanged throughout the entire lifecycle of the catalog. <i>namespace: BMECAT</i>	-	dtSTRING	20	-	-
Catalog version	CATALOG_VERSION	Mandatory	Single	Version number of the catalog. May only be reset on the target system in conjunction with a T_NEW_CATALOG transaction and not in the case of updates, see also example (Interaction of various transactions). Format: "MajorVersion"."MinorVersion" (maximum xxx.yyy) <i>namespace: BMECAT</i> Example 001.120 7.3	-	dtSTRING	7	-	1.2_fd
Catalog name	CATALOG_NAME	Optional	Single	Any name that describes the catalog. Example: Fall/Winter 2005/2006 <i>namespace: BMECAT</i>	-	dtML-STRING	100	Yes	-

ORDER_INFO

(Buyer information)

In the element ORDER_INFO administrative information on this order is summarized.





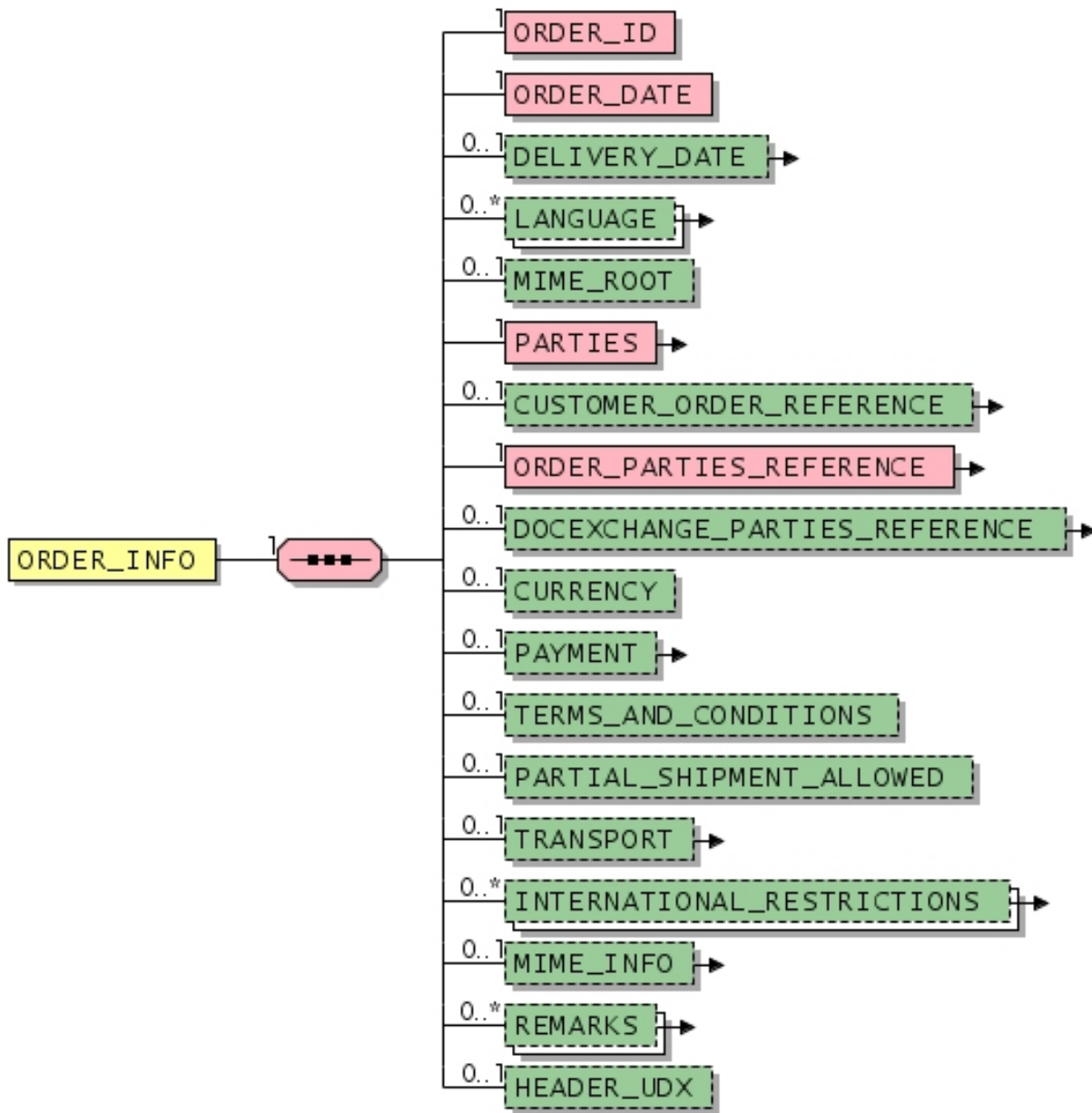

For processing improvements the sorting of the elements has been changed.







General

Used in	Default value	Data type	Field length	Lang. specific	l.chg. in ver.
ORDER_HEADER	-	-	-	-	20



Elements

Designation	Element name	Mandatory/Optional	Single/Multiple	Explanation	Default value	Data type	Field length	Lang. specific	l.chg. in ver.
Auftragsnummer des Einkäufers	ORDER_ID	Mandatory	Single	Unique order number of the buyer	-	dtSTRING	250	-	2.0
Order date	ORDER_DATE	Mandatory	Single	Date of the order	-	dtDATE-TIME	-	-	2.0
Delivery date	DELIVERY_DATE - type	Optional	Single	Date of shipment. The delivery date specifies the date the commissioned goods are accepted by the buyer. If the delivery date deviates from the one specified in the header, the delivery date on item level is valid. To specify exact one date for the shipment, e.g. in the RECEIPTACKNOWLEDGEMENT-document, both sub-elements the DELIVERY_DATE and the DELIVERY_END_DATE should be the equal. 	-	-	-	-	21fd
Language	LANGUAGE - default	Optional	Multiple	Specification of used languages, especially the default language of all language-dependent information <i>namespace: BMECAT</i>	-	dtLANG	-	-	-
MIME root directory	MIME_ROOT	Optional	Single	A relative directory can be entered here (and/or a URI), i.e. one to which the relative paths in MIME_SOURCE refer. <i>namespace: BMECAT</i>	-	dtML-STRING	250	Yes	-
Parties	PARTIES	Mandatory	Single	List of parties that are relevant to this business document 	-	-	-	-	2005fd
Customer order reference	CUSTOMER_ORDER_REFERENCE	Optional	Single	The element is related to an item and refers to the previous order where the item was ordered by the customer (purchasing party) 	-	-	-	-	20v3
Business partners	ORDER_PARTIES_REFERENCE	Mandatory	Single	Reference to the business partners integrated in the process of the document flow 	-	-	-	-	20v3
Document exchange parties	DOEXCHANGE_PARTIES_REFERENCE	Optional	Single	Reference to the business partners who take part in the document exchange 	-	-	-	-	20v3

Elements

Designation	Element name	Mandatory/ Optional	Single/ Multiple	Explanation	Default value	Data type	Field length	Lang. specific	I.chg. in ver.
Currency	CURRENCY	Optional	Single	Provides the currency that is default for all price information in the catalog. If the price of a product has a different currency, or this element is not used, the the currency has to be specified in the PRICE_CURRENCY element for the respective product.  Therefore, the currency must be specified in the catalog header or for each product separately. It is recommended to define a default currency. <i>namespace: BMECAT</i>	-	dtCUR-RENCIES	-	-	-
Mode of payment	PAYMENT	Optional	Single	Payment procedure  The PAYMENT element is to be interpreted by the recipient of the document as a requested mode of payment. The binding payment procedure is laid down in the order.	-	-	-	-	2.0
GTC	TERMS_AND_CONDITIONS	Optional	Single	General terms and conditions	-	dtSTRING	250	-	2.0
Partial shipment allowed	PARTIAL_SHIPMENT_ALLOWED	Optional	Single	Flag to indicate whether partial shipment is allowed. If allowed the value is TRUE, FALSE otherwise. The flag is binding for the order, i.e. if the value is set to FALSE and only partial shipments can be made by the recipient of the order, the order shall be invalid. Additionally one can provide concrete dates for the shipment. In contrast to the general possibility for partial shipments one can use the element PARTIAL_DELIVERY_LIST for concrete dates for partial shipments. In this case the element PARTIAL_SHIPMENT_ALLOWED is not used.  If the element is used in the context ORDER_HEADER, the element must not be used on item level ORDER_ITEM.	-	dtBOOLEAN	-	-	2.0
Transport	TRANSPORT	Optional	Single	Information about the terms of transport <i>namespace: BMECAT</i> 	-	-	-	-	2005fd
International delivery restrictions	INTERNATIONAL_RESTRICTIONS - type	Optional	Multiple	Details of international restrictions, e.g. compulsory import / export authorization. <i>namespace: BMECAT</i> 	-	dtSTRING	250	-	2005fd
Additional multimedia information	MIME_INFO	Optional	Single	Information about multimedia files	-	-	-	-	-
Remark	REMARKS - type	Optional	Multiple	Remark related to a business document	-	dtML-STRING	64000	Yes	-

Elements

Designation	Element name	Mandatory/Optional	Single/Multiple	Explanation	Default value	Data type	Field length	Lang. specific	l.chg. in ver.
User-defined extension	HEADER_UDX	Optional	Single	<p>This element can be used for transferring information in user-defined non-openTRANS-elements; hence it is possible to extend the pre-defined set of openTRANS-elements by user-defined ones. The usage of those elements results in openTRANS business documents, which can only be exchanged between the companies that have agreed on these extensions. The structure of these elements can be very complex, though it must be valid XML.</p> <p> <User Defined Extensions> are defined exclusively as optional fields. Therefore, it is expressly pointed out that if user-defined extensions are used they must be compatible with the target systems and should be clarified on a case-to-case basis.</p> <p>The names of the elements must be clearly distinguishable from the names of other elements contained in the openTRANS standard. For this reason, all element must start with the string "UDX" (Example: <UDX.supplier.elementname>).</p> <p>The definition of user-defined extensions takes place by additional XML DTD or XML Schema files.</p> <p> New element</p> <p>Example: usage of the non-openTRANS elements (XML)</p> <pre><INVOICE_INFO> ... <HEADER_UDX> <UDX.MYORG.CEO>Mr. Meier</UDX.MYORG.CEO> <UDX.MYORG.CEOTEL>+49 123 456789</UDX.MYORG.CEOTEL> </HEADER_UDX> </INVOICE_INFO></pre>	-	udxHEA- DER	-	-	20v1

DELIVERY_DATE

(Delivery date)

Date of shipment. The delivery date specifies the date the commissioned goods are accepted by the buyer. If the delivery date deviates from the one specified in the header, the delivery date on item level is valid. To specify exact one date for the shipment, e.g. in the RECEIPTACKNOWLEDGEMENT-document, both sub-elements the **DELIVERY_DATE** and the **DELIVERY_END_DATE** should be the equal.



Example added.

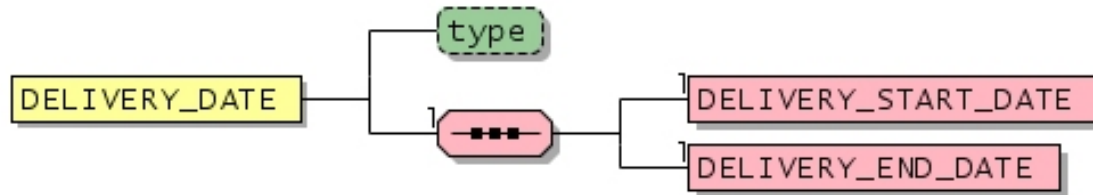

General

Used in	Default value	Data type	Field length	Lang. specific	l.chg. in ver.
ORDER_INFO, ORDER_ITEM, PARTIAL_DELIVERY	-	-	-	-	21fd

Attributes

Designation	Attribute name	Mandatory/optional	Explanation	Default value	Data type	Field length	Lang. specific	l.chg. in ver.
Type of delivery date	type	Optional	Specifies the delivery date. See also: Permitted values for attribute "type"	fixed	dtSTRING	20	-	2.0

Permitted values for attribute "type"

Designation	Attribute value	Explanation	l.chg. in ver.
Required date	optional	The date given is to be interpreted by the recipient as a required delivery date.	-
Fixed delivery date	fixed	The date given is to be interpreted by the recipient as a fixed specified delivery date.	-

Elements

Designation	Element name	Mandatory/Optional	Single/Multiple	Explanation	Default value	Data type	Field length	Lang. specific	l.chg. in ver.
Start of the delivery period	DELIVERY_START_DATE	Mandatory	Single	Unique date for the start of the delivery period. If an exact delivery date has to be determined, e.g. in the RECEIPTACKNOWLEDGEMENT-document, DELIVERY_START_DATE = DELIVERY_END_DATE is set.	-	dtDATE TIME	-	-	2.0
End of the delivery period	DELIVERY_END_DATE	Mandatory	Single	Unique date for the end of the delivery period. If an exact delivery date has to be determined, e.g. in the RECEIPTACKNOWLEDGEMENT-document, DELIVERY_START_DATE = DELIVERY_END_DATE is set.	-	dtDATE TIME	-	-	2.0

Example

```
<DELIVERY_DATE type="optional" >
  <DELIVERY_START_DATE>2009-05-11T10:00:00+01:00</DELIVERY_START_DATE>
  <DELIVERY_END_DATE>2009-05-11T10:00:00+01:00</DELIVERY_END_DATE>
</DELIVERY_DATE>
```

LANGUAGE

(Language) namespace: *BMECAT*

This element specifies the used languages, especially the default language of all language-dependent information.

Single-lingual documents: This element contains the used language. If the default-attribute is set, then it is not necessary to name the language in all elements that contain language-dependent information (default language).

Multi-lingual documents: This element must be used to specify each language that occurs in the document, therefore the element appears more than once. If the default-attribute is set for the most frequently or always used language, then it is not necessary to name for all language-dependent information this language (default language); it is sufficient to mark information in other languages.



General

Used in	Default value	Data type	Field length	Lang. specific	l.chg. in ver.
ORDER_INFO	-	dtLANG	-	-	-

Attributes

Designation	Attribute name	Mandatory/optional	Explanation	Default value	Data type	Field length	Lang. specific	l.chg. in ver.
Default flag	default	Optional	This element determines the default language of all language-dependent information in the document.  New attribute	-	dtBOOLEAN	-	-	2005fd

PARTIES

(Parties)

This element contains a list of parties that are relevant to this business document.



New element

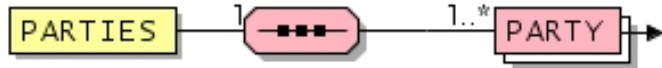

General

Used in	Default value	Data type	Field length	Lang. specific	l.chg. in ver.
ORDER_INFO	-	-	-	-	2005fd

Elements

Designation	Element name	Mandatory/Optional	Single/Multiple	Explanation	Default value	Data type	Field length	Lang. specific	l.chg. in ver.
Business partner	PARTY	Mandatory	Multiple	Information about the business partner. 	-	-	-	-	21fd

PARTY

(Business partner)

This element contains information about a business partner.

If this element is used at least one of the following elements has to be specified.



New element

Sub-element **ACCOUNT** has been added.

Sub-element **PARTY_ID** set to "mandatory". Sub-element **ADDRESS** has been set to "multiple"

Example added.

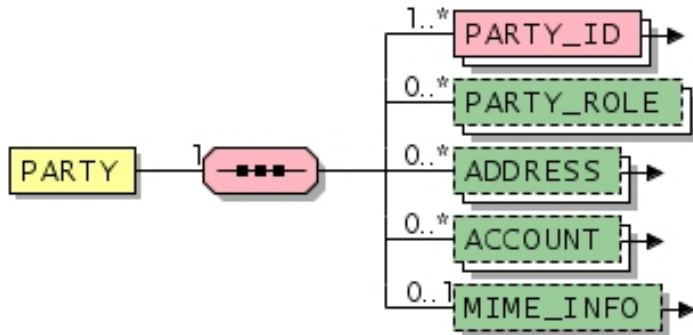



General

Used in	Default value	Data type	Field length	Lang. specific	l.chg. in ver.
PARTIES	-	-	-	-	21fd



Elements

Designation	Element name	Mandatory/Optional	Single/Multiple	Explanation	Default value	Data type	Field length	Lang. specific	l.chg. in ver.
ID of the business partner	PARTY_ID - type	Mandatory	Multiple	Unique identifier of the business partner. PARTY_ID has to be specified as the document contains references to this element. <i>namespace: BMECAT</i>	-	dtSTRING	250	-	2005fd









Elements

Designation	Element name	Mandatory/Optional	Single/Multiple	Explanation	Default value	Data type	Field length	Lang. specific	l.chg. in ver.
Role of the business partner	PARTY_ROLE	Optional	Multiple	Role of the business partner in the context of this document  New element The list of pre-defined values has been extended with 'invoice_issuer' (invoicing party), 'invoice_recipient' (invoice receiving party) and 'deliverer' (transportation party, carrier). The list of pre-defined values has been extended with 'intermediary' (intermediate party), 'marketplace' (market place), 'payer', 'remittee' and 'central_regulator' (in case of centralized settlement). The list of pre-defined values has been extended with 'other'. The list of pre-defined values has been extended with 'TrustedThirdParty'. See also: Permitted values for element PARTY_ROLE	-	dtSTRING	20	-	21fd
Address	ADDRESS	Optional	Multiple	Address information of a business partner 	-	-	-	-	21fd
Bank account	ACCOUNT	Optional	Multiple	Bank account details 	-	-	-	-	21fd
Additional multimedia information	MIME_INFO	Optional	Single	Information about multimedia files For example logos, company profiles or other business partner related documents could be added here.	-	-	-	-	-







Permitted values for element PARTY_ROLE

Designation	Element value	Explanation	l.chg. in ver.
Buyer	buyer	The business partner is a buyer.	2005fd
Centralized settlement	central_regulator	The business party is a centralized settlement and supports the business of several partners.  New value	20v3
Customer	customer	The business party is the customer of the buying company.  New value	20v3
Transportation party, carrier	deliverer	The business party is the carrier.  New value	20v2

Permitted values for element PARTY_ROLE

Designation	Element value	Explanation	l.chg. in ver.
Location of shipment	delivery	The business party is the location of the product shipment or where the service is afforded.  New value	20v3
Document creator	document_creator	The business partner is the creator of the document.  New value	2005fd
Final shipment location	final_delivery	Reference to address and contact of the final recipient.  The federal office of export control currently only evaluates on order-header-level. Therefore orders related to exports should not use a party in this element which is different to the header-level element FINAL_DELIVERY_PARTY .  New value	20v3
Intermediate	intermediary	The business party is an intermediate between product/service provider and benefit recipient.  New value	20v3
Invoicing party	invoice_issuer	The business party is the invoicing party.  New value	20v2
Invoice recipient	invoice_recipient	The business party is the invoice receiving party.  New value	20v2
IPP operator	ipp_operator	The business partner operates an IPP application.  New value	2005fd
Manufacturer	manufacturer	The business partner is a manufacturer.  New value	2005fd

Permitted values for element PARTY_ROLE

Designation	Element value	Explanation	l.chg. in ver.
Market place	marketplace	The business party runs an electronic market place supporting the processing of procurement and distribution of products and services.  New value	20v3
Payer	payer	The business party is the payer.  New value	20v3
Remittee	remittee	The business party is the remittee.  New value	20v3
Standardization body	standardization_body	The business partner is a standardization body.  New value	2005fd
Supplier	supplier	The business partner is a supplier.  New value	2005fd
Trusted Third Party	trustedthirdparty	A trusted instance that e.g. signed and verified the attached digital signature.  New value	21fd
Other	other	If no other role matches this value can be used.  New value	20

Example

```

<PARTY>
  <bmeecat:PARTY_ID type="supplier_specific">108304</bmeecat:PARTY_ID>
  <PARTY_ROLE>document_creator</PARTY_ROLE>
  <ADDRESS>
    <bmeecat:NAME>Power Supply Corp.</bmeecat:NAME>
    <CONTACT_DETAILS>
      <bmeecat:CONTACT_ID>MA02</bmeecat:CONTACT_ID>
      <bmeecat:CONTACT_NAME>Doe</bmeecat:CONTACT_NAME>
      <bmeecat:FIRST_NAME>John</bmeecat:FIRST_NAME>
      <bmeecat:ACADEMIC_TITLE>Phd</bmeecat:ACADEMIC_TITLE>
    </CONTACT_DETAILS>
    <bmeecat:STATE>Saxony Anhalt</bmeecat:STATE>
    <bmeecat:COUNTRY>Germany</bmeecat:COUNTRY>
    <bmeecat:COUNTRY_CODED>DE</bmeecat:COUNTRY_CODED>
    <bmeecat:PHONE>+49 345 WE SELL</bmeecat:PHONE>
    <bmeecat:FAX>+49 555 77 88 99</bmeecat:FAX>
    <bmeecat:EMAIL>power@supply.com</bmeecat:EMAIL>
    <bmeecat:URL>www.powersupplycorp.com</bmeecat:URL>
  </ADDRESS>
  <ACCOUNT>
    <HOLDER>Power Supply Corp.</HOLDER>
    <BANK_ACCOUNT type="iban">DE12 3456 7890 0000 9999 99</BANK_ACCOUNT>
    <BANK_CODE type="bic">1002003040</BANK_CODE>
    <BANK_NAME>Good Bank</BANK_NAME>
    <BANK_COUNTRY>DE</BANK_COUNTRY>
  </ACCOUNT>
</PARTY>

```

PARTY_ID

(ID of the business partner) *namespace: BMECAT*

This element contains the unique identifier of the business partner. **PARTY_ID** has to be specified as the document contains references to this element.



New element

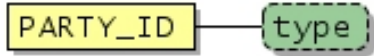

General

Used in	Default value	Data type	Field length	Lang. specific	l.chg. in ver.
PARTY	-	dtSTRING	250	-	2005fd

Attributes

Designation	Attribute name	Mandatory/optional	Explanation	Default value	Data type	Field length	Lang. specific	l.chg. in ver.
Coding standard	type	Optional	This attribute is used to state the coding standard to which the identifier (PARTY_ID) adheres. The most common coding standards are predefined. See also: Predefined values for attribute "type"	-	dtSTRING	250	-	1.2_fd

Predefined values for attribute "type"

Designation	Attribute value	Explanation	l.chg. in ver.
Buyer-specific number	buyer_specific	Identification number defined by the buyer	-
Customer specific number	customer_specific	Identification number defined by the customer	2005fd
Dun & Bradstreet	duns	DUNS-Number (see also http://dbuk.dnb.com/english/DataBase/duns.htm)	-
Global location number	iln	Internationally called GLN (see GLN below)	-
Global location number	gln	Global Location Number GLN (see also http://www.ean-int.org/locations.html)	2005fd
Party-specific number	party_specific	Identification number defined by the respective party	2005fd
Supplier-specific number	supplier_specific	Identification number defined by the supplier	-
Other codification standard	User defined value, format: \w{1,250}	Identificator of codification standard. "\w{1,250}" means that the identificator of the codification standard has to be at least 1 character long up to a maximum of 250 characters.	-

ADDRESS

(Address)

This element is used to transfer address information of a business partner.



This element has been extended by the following sub-elements: **DEPARTMENT**, **CONTACT_DETAILS**, **VAT_ID**; the sub-element **EMAIL** may occur more than once if the e-mail address comes with an element **PUBLIC_KEY**.

The sub-elements **PHONE** und **FAX** may occur more than once, due to their type-attribute.

The sub-element **CONTACT_DETAILS** was accidentally deleted in the draft version and is now inserted again.

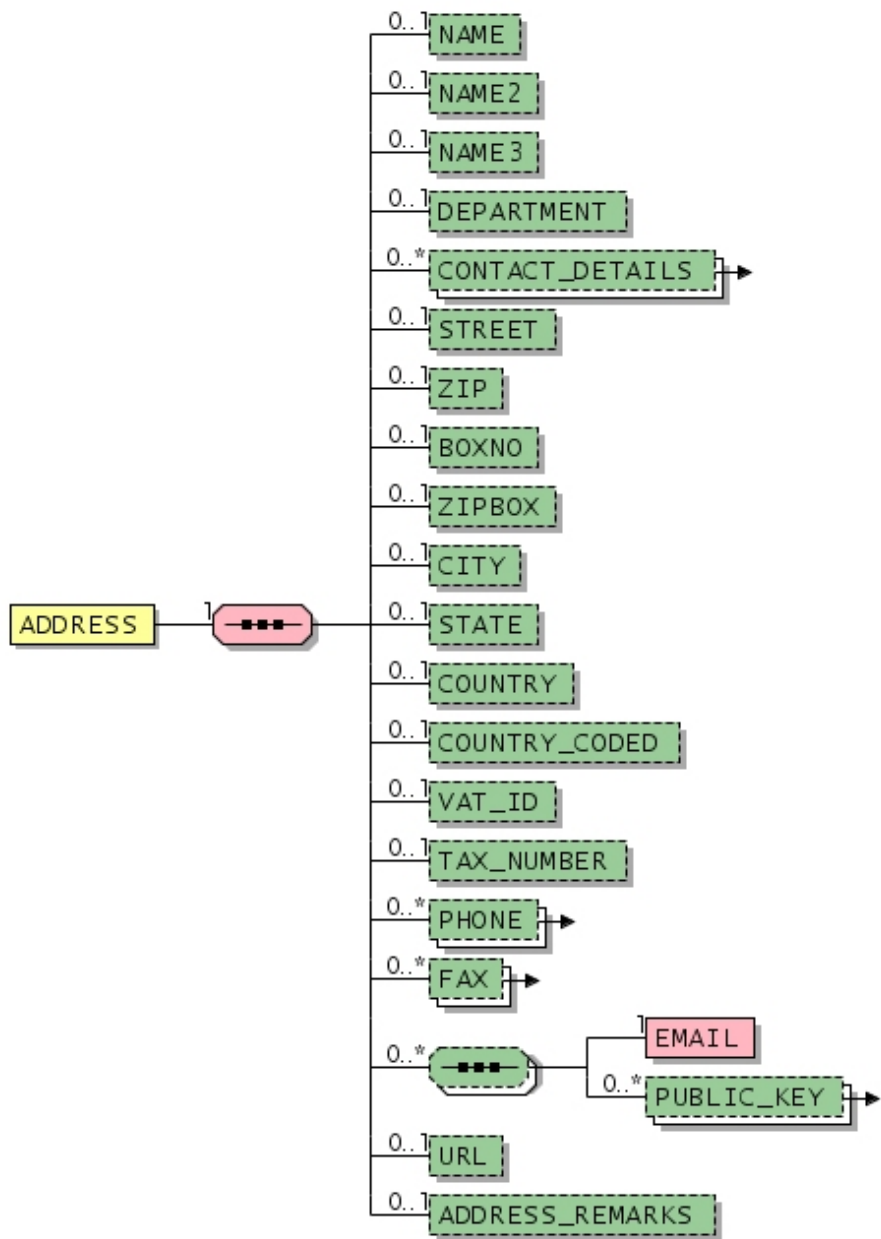

Example adapted.









General

Used in	Default value	Data type	Field length	Lang. specific	I.chg. in ver.
PARTY	-	-	-	-	21fd

Elements

Designation	Element name	Mandatory/Optional	Single/Multiple	Explanation	Default value	Data type	Field length	Lang. specific	I.chg. in ver.
Address line	NAME	Optional	Single	First address line, in most cases the name of the organisation <i>namespace: BMECAT</i>	-	dtML-STRING	50	Yes	-
Address line 2	NAME2	Optional	Single	additional space for address information <i>namespace: BMECAT</i>	-	dtML-STRING	50	Yes	-
Address line 3	NAME3	Optional	Single	additional space for address information <i>namespace: BMECAT</i>	-	dtML-STRING	50	Yes	-
Department	DEPARTMENT	Optional	Single	Department of the organisation <i>namespace: BMECAT</i>  New element	-	dtML-STRING	50	Yes	2005fd
Contact	CONTACT_DETAILS	Optional	Multiple	Information on a contact person 	-	-	-	-	21fd
Street	STREET	Optional	Single	Street name and house number <i>namespace: BMECAT</i>	-	dtML-STRING	50	Yes	-
Zip code	ZIP	Optional	Single	ZIP code of address <i>namespace: BMECAT</i>	-	dtML-STRING	20	Yes	-
P.O. Box	BOXNO	Optional	Single	P.O. box number <i>namespace: BMECAT</i>	-	dtML-STRING	20	Yes	-
Zip code of P.O. Box	ZIPBOX	Optional	Single	ZIP code of P.O. box <i>namespace: BMECAT</i>	-	dtML-STRING	20	Yes	-
Town or city	CITY	Optional	Single	Town or city of the company <i>namespace: BMECAT</i>	-	dtML-STRING	50	Yes	-
Federal state	STATE	Optional	Single	Federal state, e.g., Michigan <i>namespace: BMECAT</i>	-	dtML-STRING	50	Yes	-
Country	COUNTRY	Optional	Single	Country, e.g., France <i>namespace: BMECAT</i>	-	dtML-STRING	50	Yes	-

Elements										
Designation	Element name	Mandatory/Optional	Single/Multiple	Explanation	Default value	Data type	Field length	Lang. specific	l.chg. in ver.	
Country code	COUNTRY_CODED	Optional	Single	Country code, e.g. FR for France <i>namespace: BMECAT</i>  New element	-	dtCOUNTRIES	-	-	2005fd	
VAT-ID	VAT_ID	Optional	Single	VAT identification number of the business partner <i>namespace: BMECAT</i>  New element	-	dtSTRING	50	-	2005fd	
Tax number	TAX_NUMBER	Optional	Single	Tax number of a business partner  New element	-	dtSTRING	50	-	20v2	
Phone number	PHONE - type	Optional	Multiple	Phone number including type <i>namespace: BMECAT</i> 	-	dtML-STRING	50	Yes	2005fd	
Fax number	FAX - type	Optional	Multiple	Fax number <i>namespace: BMECAT</i>	-	dtML-STRING	50	Yes	-	
E-mail address	EMAIL	Mandatory	Single	e-mail address <i>namespace: BMECAT</i>  The maximum length has been extended from 100 characters to 250 characters.	-	dtSTRING	255	-	2005fd	
Public key	PUBLIC_KEY - type	Optional	Multiple	Public key, e.g. PGP <i>namespace: BMECAT</i>	-	dtSTRING	64000	-	1.2_fd	
Internet address	URL	Optional	Single	URL of the web site, e.g., http://www.bmecat.org <i>namespace: BMECAT</i>  The maximum length has been extended from 100 characters to 250 characters.	-	dtSTRING	255	-	2005fd	
Remarks	ADDRESS_REMARKS	Optional	Single	Remarks on the organization <i>namespace: BMECAT</i>	-	dtML-STRING	250	Yes	-	

Example

```

<ADDRESS>
  <bmeecat:NAME>Fraunhofer Society</bmeecat:NAME>
  <bmeecat:NAME2>Institute for industrial engineering</bmeecat:NAME2>
  <bmeecat:DEPARTMENT>Competence Center E-Business</bmeecat:DEPARTMENT>
  <CONTACT_DETAILS>
    <bmeecat:CONTACT_ID>MA02</bmeecat:CONTACT_ID>
    <bmeecat:CONTACT_NAME>Doe</bmeecat:CONTACT_NAME>
    <bmeecat:FIRST_NAME>John</bmeecat:FIRST_NAME>
    <bmeecat:ACADEMIC_TITLE>Phd</bmeecat:ACADEMIC_TITLE>
    <bmeecat:PHONE>+49 999 777 9981</bmeecat:PHONE>
    <bmeecat:FAX>+49 999 777 9900</bmeecat:FAX>
    <bmeecat:EMAILS>max@mustermann.de</bmeecat:EMAILS>
  </CONTACT_DETAILS>
  <bmeecat:STREET>Nobelstr. 12</bmeecat:STREET>
  <bmeecat:ZIP>70569</bmeecat:ZIP>
  <bmeecat:CITY>Stuttgart</bmeecat:CITY>
  <bmeecat:STATE>Baden-Württemberg</bmeecat:STATE>
  <bmeecat:COUNTRY>Germany</bmeecat:COUNTRY>
  <bmeecat:COUNTRY_CODED>DE</bmeecat:COUNTRY_CODED>
  <bmeecat:VAT_ID>DE 129515865</bmeecat:VAT_ID>
  <bmeecat:PHONE>+49 345 ECOMMERCE</bmeecat:PHONE>
  <bmeecat:FAX>+49 555 77 88 99</bmeecat:FAX>
  <bmeecat:EMAIL>info@iao.fraunhofer.de</bmeecat:EMAIL>
  <bmeecat:URL>http://www.fraunhofer.de</bmeecat:URL>
</ADDRESS>

```

CONTACT_DETAILS

(Contact)

This element contains informations about a contact person.



New element

The sub-elements **PHONE** und **FAX** may occur more than once, due to their type-attribute.

AUTHENTICATION was added as sub-element.



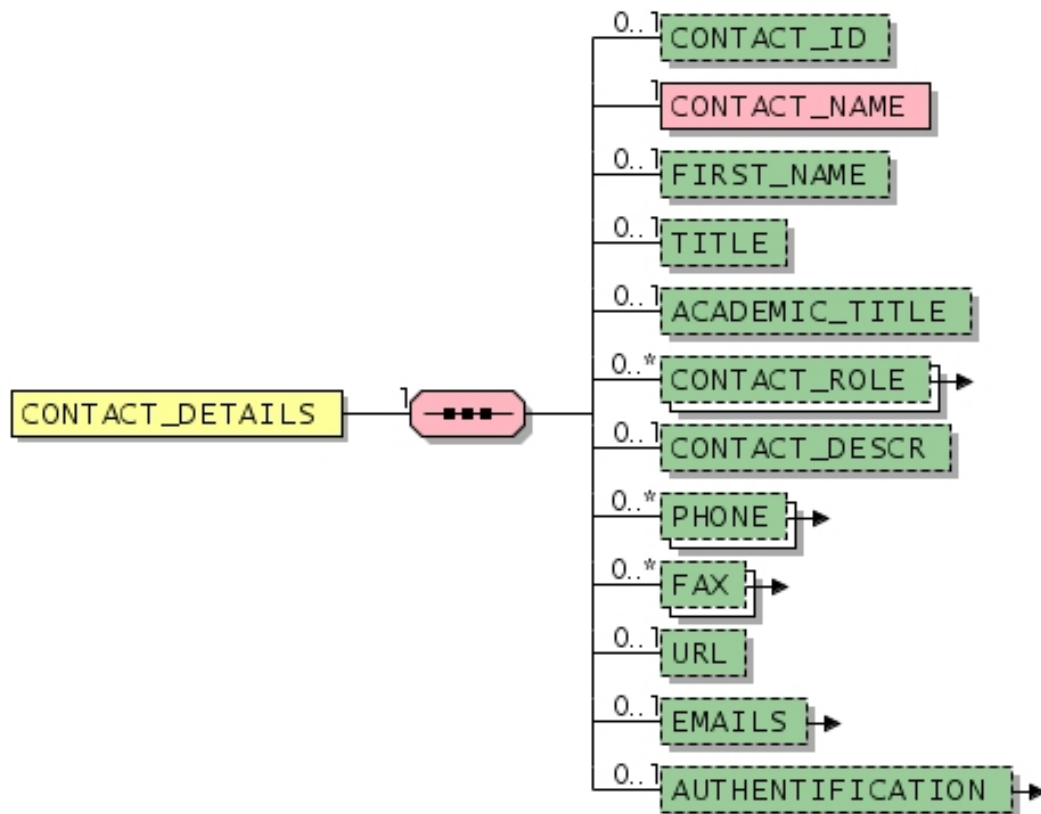



Changed sub-element **CONTACT_ID** to optional. Example added.





General

Used in	Default value	Data type	Field length	Lang. specific	I.chg. in ver.
ADDRESS	-	-	-	-	21fd

Elements

Designation	Element name	Mandatory/Optional	Single/Multiple	Explanation	Default value	Data type	Field length	Lang. specific	I.chg. in ver.
Contact ID	CONTACT_ID	Optional	Single	Unique ID of the contact person. <i>namespace: BMECAT</i>  New element The maximum length has been extended from 50 characters to 60 characters.	-	dtSTRING	60	-	2005
Contact name	CONTACT_NAME	Mandatory	Single	Last name of the contact <i>namespace: BMECAT</i>  New element	-	dtML-STRING	50	Yes	2005fd
First name	FIRST_NAME	Optional	Single	First name of the contact person <i>namespace: BMECAT</i>	-	dtML-STRING	50	Yes	-
Title	TITLE	Optional	Single	Form of address, e.g., Mr., Ms. <i>namespace: BMECAT</i>  New element	-	dtML-STRING	20	Yes	2005fd
Academic title	ACADEMIC_TITLE	Optional	Single	Academic title of the contact person, e.g., Dr. <i>namespace: BMECAT</i>  New element	-	dtML-STRING	50	Yes	2005fd
Role	CONTACT_ROLE - type	Optional	Multiple	Role or position of a contact 	-	dtML-STRING	50	Yes	2005fd
Contact description	CONTACT_DESCR	Optional	Single	Additional information on the contact person <i>namespace: BMECAT</i>  New element	-	dtML-STRING	250	Yes	2005fd
Phone number	PHONE - type	Optional	Multiple	Phone number including type <i>namespace: BMECAT</i> 	-	dtML-STRING	50	Yes	2005fd
Fax number	FAX - type	Optional	Multiple	Fax number <i>namespace: BMECAT</i>	-	dtML-STRING	50	Yes	-

Elements

Designation	Element name	Mandatory/Optional	Single/Multiple	Explanation	Default value	Data type	Field length	Lang. specific	l.chg. in ver.
Internet address	URL	Optional	Single	URL of the web site, e.g., http://www.bmecat.org <i>namespace: BMECAT</i>  The maximum length has been extended from 100 characters to 250 characters.	-	dtSTRING	255	-	2005fd
E-mail addresses	EMAILS	Optional	Single	List of e-mail addresses <i>namespace: BMECAT</i> 	-	-	-	-	2005fd
Authentication information	AUTHENTICATION	Optional	Single	Authentication information <i>namespace: BMECAT</i> 	-	-	-	-	2005fd

Example

```

<CONTACT_DETAILS>
  <bmecat:CONTACT_ID>MA02</bmecat:CONTACT_ID>
  <bmecat:CONTACT_NAME>Doe</bmecat:CONTACT_NAME>
  <bmecat:FIRST_NAME>John</bmecat:FIRST_NAME>
  <bmecat:ACADEMIC_TITLE>Phd</bmecat:ACADEMIC_TITLE>
</CONTACT_DETAILS>

```

CONTACT_ROLE

(Role)

This element describes the role or position of the contact person.



New element

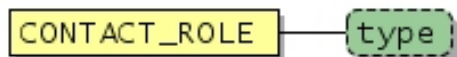

General

Used in	Default value	Data type	Field length	Lang. specific	l.chg. in ver.
CONTACT_DETAILS	-	dtML-STRING	50	Yes	2005fd

Attributes

Designation	Attribute name	Mandatory/optional	Explanation	Default value	Data type	Field length	Lang. specific	l.chg. in ver.
Coded role	type	Optional	This attribute contains the role or position as a machine-readable code.  The list of pre defined values was extended. New items are 'document_issuer' (intermediator), 'market-place', 'payer', 'remittee' and 'central_regulator' (regulator for centralized settlement). See also: Permitted values for attribute "type"	-	dtSTRING	20	-	20v3

Permitted values for attribute "type"

Designation	Attribute value	Explanation	l.chg. in ver.
Administrative	administrativ	Contact concerning administrative questions	2005fd
Commercial	commercial	Contact concerning commercial questions	2005fd
document trigger	document_issuer	The one who triggered the document, e.g. the one who placed an order.	20v3
Special treatment	special_treatment	Contact concerning the handling of special products	2005fd
Technical	technical	Contact concerning technical questions	2005fd
Other	others	Contact concerning general questions	2005fd

PHONE

(Phone number) namespace: *BMECAT*

This element contains a phone number. The respective attribute defines the type of the phone.



The maximum length has been extended from 30 characters to 50 characters.



General

Used in	Default value	Data type	Field length	Lang. specific	l.chg. in ver.
ADDRESS, CONTACT_DETAILS	-	dtML-STRING	50	Yes	2005fd

Attributes

Designation	Attribute name	Mandatory/optional	Explanation	Default value	Data type	Field length	Lang. specific	l.chg. in ver.
Type of phone number	type	Optional	Specifies the type of the phone number. New attribute See also: Predefined values for attribute "type"	-	dtSTRING	50	-	2005fd

Predefined values for attribute "type"

Designation	Attribute value	Explanation	l.chg. in ver.
Mobile telephone	mobile	Mobile phone number	2005fd
Office	office	Office phone number	2005fd
Private	private	Private phone number	2005fd
Self-defined type	User defined value, format: \w{1,50}	Phone types may be self-defined and have to be 1 character at the minimum and not more than 50 characters.	2005fd

Example

```

<PHONE type="office">+49 201 183 4084</PHONE>
<PHONE type="private">+49 201 12345678</PHONE>
<PHONE type="mobile">+49 170 12345678</PHONE>
  
```

FAX

(Fax number) namespace: BMECAT

This element contains a fax number.



General

Used in	Default value	Data type	Field length	Lang. specific	l.chg. in ver.
ADDRESS, CONTACT_DETAILS	-	dtML-STRING	50	Yes	-

Attributes

Designation	Attribute name	Mandatory/optional	Explanation	Default value	Data type	Field length	Lang. specific	l.chg. in ver.
Phone type	type	Optional	Specifies the type of the phone number.  New attribute See also: Predefined values for attribute "type"	-	dtSTRING	50	-	2005fd

Predefined values for attribute "type"

Designation	Attribute value	Explanation	l.chg. in ver.
Office	office	Office fax number	2005fd
Private	private	Private fax number	2005fd
Self-defined type	User defined value, format: \w{1,50}	Fax types may be self-defined and have to be 1 character at the minimum and not more than 50 characters.	2005fd

EMAILS

(E-mail addresses) *namespace: BMECAT*

This element contains a list of e-mail addresses.



New element

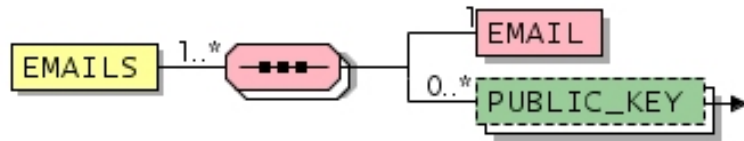

General

Used in	Default value	Data type	Field length	Lang. specific	l.chg. in ver.
CONTACT_DETAILS	-	-	-	-	2005fd

Elements

Designation	Element name	Mandatory/Optional	Single/Multiple	Explanation	Default value	Data type	Field length	Lang. specific	l.chg. in ver.
E-mail address	EMAIL	Mandatory	Single	e-mail address <i>namespace: BMECAT</i>  The maximum length has been extended from 100 characters to 250 characters.	-	dtSTRING	255	-	2005fd
Public key	PUBLIC_KEY - type	Optional	Multiple	Public key, e.g. PGP <i>namespace: BMECAT</i>	-	dtSTRING	64000	-	1.2_fd

PUBLIC_KEY(Public key) *namespace: BMECAT*

Indicates the public key, e.g. PGP, of the person addressed here.

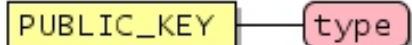
**General**

Used in	Default value	Data type	Field length	Lang. specific	l.chg. in ver.
ADDRESS, EMAILS	-	dtSTRING	64000	-	1.2_fd

Attributes

Designation	Attribute name	Mandatory/optional	Explanation	Default value	Data type	Field length	Lang. specific	l.chg. in ver.
Type of coding process	type	Mandatory	This attribute indicates the Public Key coding process in which the e-mail is coded. Must comply with the format "<Name>-<MajorVersion>.<MinorVersions>". Example.: PGP-6.5.1	-	dtSTRING	50	-	1.2_fd

AUTHENTICATION

(Authentication information) *namespace: BMECAT*

This element contains authentication information that is forwarded to the respective application.



New element

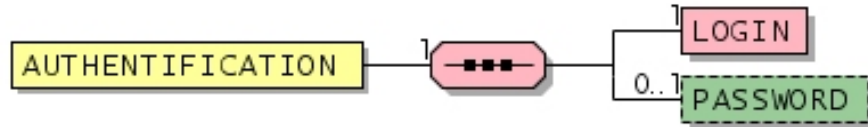

General

Used in	Default value	Data type	Field length	Lang. specific	l.chg. in ver.
CONTACT_DETAILS	-	-	-	-	2005fd

Elements

Designation	Element name	Mandatory/Optional	Single/Multiple	Explanation	Default value	Data type	Field length	Lang. specific	l.chg. in ver.
Login	LOGIN	Mandatory	Single	Login as part of the authentication <i>namespace: BMECAT</i> New element	-	dtSTRING	60	-	2005fd
Password	PASSWORD	Optional	Single	Password for the login. <i>namespace: BMECAT</i> New element	-	dtSTRING	20	-	2005fd

ACCOUNT

(Bank account)

The ACCOUNT element summarizes information about bank accounts.



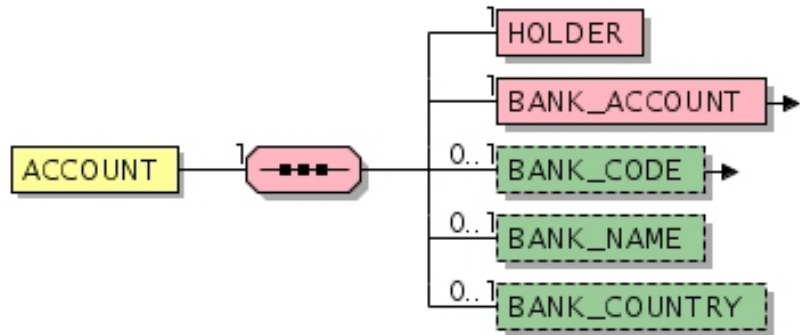

The sub-element **PAYMENT_TERM** was deferred to the element **PAYMENT_TERMS**.
Example added.



General

Used in	Default value	Data type	Field length	Lang. specific	l.chg. in ver.
PARTY, PAYMENT	-	-	-	-	21fd

Elements

Designation	Element name	Mandatory/Optional	Single/Multiple	Explanation	Default value	Data type	Field length	Lang. specific	l.chg. in ver.
Account holder	HOLDER	Mandatory	Single	Name of the account holder	-	dtSTRING	50	-	2.0
Account number	BANK_ACCOUNT - type	Mandatory	Single	Code to identify an account; the attribute "type" determines the coding of the account  Many coding-standards do not allow that the credit institution or bank is stored in the account number. In those cases the credit institution is quoted via the BANK_CODE -element. 	-	dtSTRING	100	-	20fd

Elements

Designation	Element name	Mandatory/Optional	Single/Multiple	Explanation	Default value	Data type	Field length	Lang. specific	l.chg. in ver.
Bank code	BANK_CODE - type	Optional	Single	Bank identification number; the attribute "type" indicates the coding of this number 	-	dtSTRING	50	-	20v2
Bank name	BANK_NAME	Optional	Single	Name of the bank	-	dtSTRING	50	-	2.0
Country	BANK_COUNTRY	Optional	Single	Country in which the bank account is managed.	-	dtCOUNTRIES	-	-	2.0

Example

```

<ACCOUNT>
  <HOLDER>Power Supply Corp.</HOLDER>
  <BANK_ACCOUNT type="iban">DE00111122223333123</BANK_ACCOUNT>
  <BANK_CODE type="bic">11110011222</BANK_CODE>
  <BANK_NAME>Good Bank</BANK_NAME>
  <BANK_COUNTRY>DE</BANK_COUNTRY>
</ACCOUNT>
    
```

BANK_ACCOUNT

(Account number)

Code to identify an account; the attribute "type" determines the coding of the account



Many coding-standards do not allow that the credit institution or bank is stored in the account number. In those cases the credit institution is quoted via the **BANK_CODE**-element.



New attribut 'type' inserted.

New attribut 'standard' inserted.

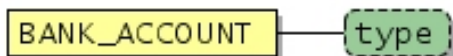

General

Used in	Default value	Data type	Field length	Lang. specific	l.chg. in ver.
ACCOUNT	-	dtSTRING	100	-	20fd

Attributes

Designation	Attribute name	Mandatory/ optional	Explanation	Default value	Data type	Field length	Lang. specific	l.chg. in ver.
Coding of the account number	type	Optional	Attribute indicating the coding-standard for the account number.  New attribute See also: Predefined values for attribute "type"	-	dtSTRING	20	-	20v2

Predefined values for attribute "type"

Designation	Attribute value	Explanation	l.chg. in ver.
Bank Account Number	standard	Bank account number, in opposite to the IBAN-Coding without informations to the credit institution. In case of the value 'standard' of the attribute 'type', for unique identification the element BANK_CODE must be specified.	20v2
International Bank Account Number	iban	global unique identifier of an account including coding of the credit institution (ISO 13616:2003); http://www.swift.com/index.cfm?item_id=61731	20v2

Predefined values for attribute "type"

Designation	Attribute value	Explanation	l.chg. in ver.
User defined type	User defined value, format: \w{1,20}	Identification of the user defined type . "\w{1,20}" means that the type identification has to be at least 1 character long up to a maximum of 20 characters.	20v2

BANK_CODE

(Bank code)

Bank identification number; the attribute "type" indicates the coding of this number

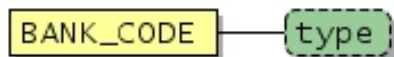

Added new attribute 'type'.

**General**

Used in	Default value	Data type	Field length	Lang. specific	l.chg. in ver.
ACCOUNT	-	dtSTRING	50	-	20v2

Attributes

Designation	Attribute name	Mandatory/optional	Explanation	Default value	Data type	Field length	Lang. specific	l.chg. in ver.
Coding of the bank identification number	type	Optional	The attribute indicates the coding of the bank code. New attribute See also: Predefined values for attribute "type"	-	dtSTRING	20	-	20v2

Predefined values for attribute "type"

Designation	Attribute value	Explanation	l.chg. in ver.
Bank Identifier Code	bic	Bank Identification according to the SWIFT Coding (ISO 9362); http://www.swift.com	20v2
User defined type	User defined value, format: \w{1,20}	Identification of the user defined type . "\w{1,20}" means that the type identification has to be at least 1 character long up to a maximum of 20 characters.	20v2

CUSTOMER_ORDER_REFERENCE

(Customer order reference)

The element is related to an item and refers to the previous order where the item was ordered by the customer (purchasing party).



New element

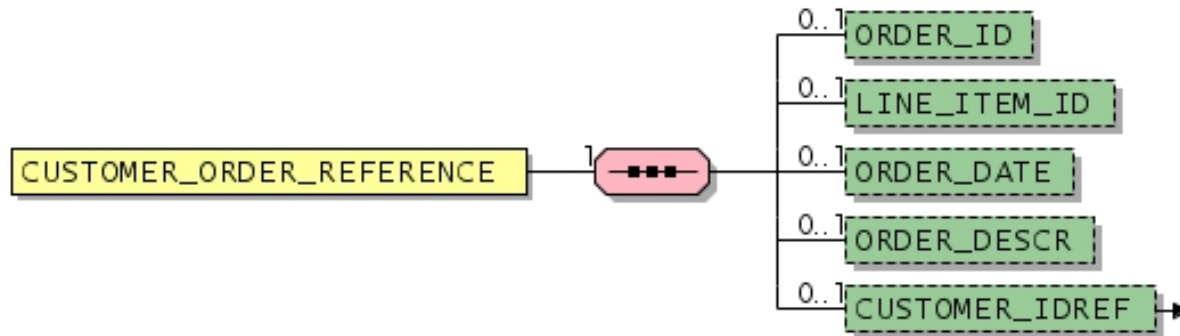

General

Used in	Default value	Data type	Field length	Lang. specific	l.chg. in ver.
ORDER_INFO, ORDER_ITEM	-	-	-	-	20v3

Elements

Designation	Element name	Mandatory/Optional	Single/Multiple	Explanation	Default value	Data type	Field length	Lang. specific	l.chg. in ver.
Auftragsnummer des Einkäufers	ORDER_ID	Optional	Single	Unique order number of the buyer	-	dtSTRING	250	-	2.0
Item number	LINE_ITEM_ID	Optional	Single	The item ID number is used to uniquely identify the item line of an order within that order. In combination with the order number and the buyer the item number represents a unique ID number outside the business process concerned.Example.: P100012	-	dtSTRING	50	-	2.0
Order date	ORDER_DATE	Optional	Single	Date of the order	-	dtDATE-TIME	-	-	2.0
Description of the order	ORDER_DESCR	Optional	Single	Textual description of the order New element	-	dtML-STRING	300	Yes	20v1

Elements

Designation	Element name	Mandatory/ Optional	Single/ Multiple	Explanation	Default value	Data type	Field length	Lang. specific	l.chg. in ver.
Reference to a customer	CUSTOMER_IDREF - type	Optional	Single	Reference to a unique identifier of a customer of the purchasing company. The reference has to refer to a PARTY_ID in the same document 	-	dtSTRING	250	-	20v3

CUSTOMER_IDREF

(Reference to a customer)

Reference to a unique identifier of a customer of the purchasing company. The reference has to refer to a **PARTY_ID** in the same document.

New element

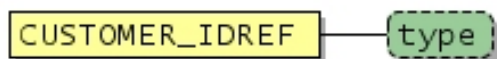

General

Used in	Default value	Data type	Field length	Lang. specific	l.chg. in ver.
CUSTOMER_ORDER_REFERENCE	-	dtSTRING	250	-	20v3

Attributes

Designation	Attribute name	Mandatory/optional	Explanation	Default value	Data type	Field length	Lang. specific	l.chg. in ver.
Coding standard	type	Optional	This attribute is used to state the coding standard to which the identifier (PARTY_ID) adheres. The most common coding standards are predefined. See also: Predefined values for attribute "type"	-	dtSTRING	250	-	1.2_fd

Predefined values for attribute "type"

Designation	Attribute value	Explanation	l.chg. in ver.
Buyer-specific number	buyer_specific	Identification number defined by the buyer	-
Customer specific number	customer_specific	Identification number defined by the customer	2005fd
Dun & Bradstreet	duns	DUNS-Number (see also http://dbuk.dnb.com/english/DataBase/duns.htm)	-
Global location number	iln	Internationally called GLN (see GLN below)	-
Global location number	gln	Global Location Number GLN (see also http://www.ean-int.org/locations.html)	2005fd
Party-specific number	party_specific	Identification number defined by the respective party	2005fd
Supplier-specific number	supplier_specific	Identification number defined by the supplier	-
Other codification standard	User defined value, format: \w{1,250}	Identificator of codification standard. "\w{1,250}" means that the identificator of the codification standard has to be at least 1 character long up to a maximum of 250 characters.	-

ORDER_PARTIES_REFERENCE

(Business partners)

Reference to the business partners integrated in the process of the document flow.



In combination with the element **PARTY**, this new element replaces the element ORDER_PARTIES.

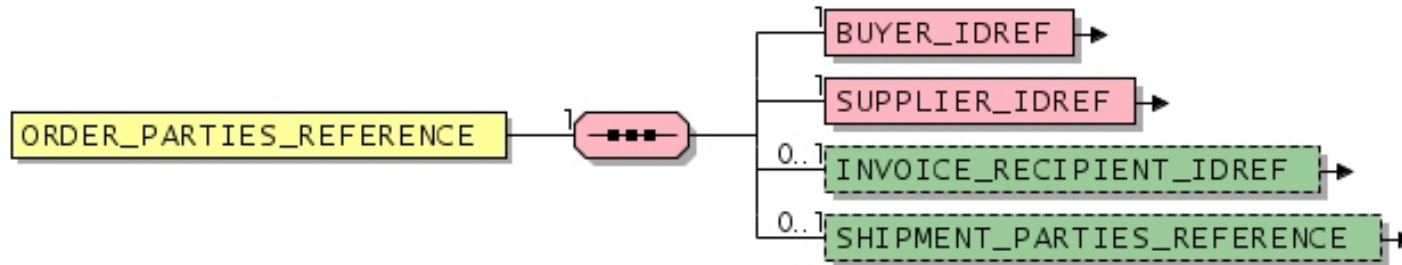

General

Used in	Default value	Data type	Field length	Lang. specific	l.chg. in ver.
ORDER_INFO	-	-	-	-	20v3

Elements

Designation	Element name	Mandatory/Optional	Single/Multiple	Explanation	Default value	Data type	Field length	Lang. specific	l.chg. in ver.
Reference to the buyer	BUYER_IDREF - type	Mandatory	Single	Reference to the buyer. It contains the unique identifier (PARTY_ID) of the respective party that is defined in the document (PARTY element). <i>namespace: BMECAT</i>	-	dtSTRING	250	-	2005fd
Reference to supplier	SUPPLIER_IDREF - type	Mandatory	Single	Reference to the supplier. It contains the unique identifier (PARTY_ID) of the respective party that is defined in the document (element PARTY). <i>namespace: BMECAT</i>	-	dtSTRING	250	-	2005fd
Reference to the recipient of the invoice	INVOICE_RECIPIENT_IDREF - type	Optional	Single	Reference to an unique identifier to the recipient of the invoice. The element refers to a PARTY_ID of an invoice recipient in the same document	-	dtSTRING	250	-	20v2
Shipment parties	SHIPMENT_PARTIES_REFERENCE	Optional	Single	Refers to business partners integrated in the process of the goods delivery procedure.	-	-	-	-	20v3

BUYER_IDREF(Reference to the buyer) *namespace: BMECAT*This element contains a reference to the buyer. The reference has to point to a (**PARTY_ID**) that is defined in the document (**PARTY** element).This new element replaces together with the **PARTY** element the **BUYER** element.**General**

Used in	Default value	Data type	Field length	Lang. specific	l.chg. in ver.
ORDER_PARTIES_REFERENCE	-	dtSTRING	250	-	2005fd

Attributes

Designation	Attribute name	Mandatory/optional	Explanation	Default value	Data type	Field length	Lang. specific	l.chg. in ver.
Coding standard	type	Optional	This attribute is used to state the coding standard to which the identifier (PARTY_ID) adheres. The most common coding standards are predefined. See also: Predefined values for attribute "type"	-	dtSTRING	250	-	1.2_fd

Predefined values for attribute "type"

Designation	Attribute value	Explanation	l.chg. in ver.
Buyer-specific number	buyer_specific	Identification number defined by the buyer	-
Customer specific number	customer_specific	Identification number defined by the customer	2005fd
Dun & Bradstreet	duns	DUNS-Number (see also http://dbuk.dnb.com/english/DataBase/duns.htm)	-
Global location number	iln	Internationally called GLN (see GLN below)	-
Global location number	gln	Global Location Number GLN (see also http://www.ean-int.org/locations.html)	2005fd
Party-specific number	party_specific	Identification number defined by the respective party	2005fd
Supplier-specific number	supplier_specific	Identification number defined by the supplier	-
Other codification standard	User defined value, format: \w{1,250}	Identificator of codification standard. "\w{1,250}" means that the identificator of the codification standard has to be at least 1 character long up to a maximum of 250 characters.	-

INVOICE_RECIPIENT_IDREF

(Reference to the recipient of the invoice)

Reference to an unique identifier to the recipient of the invoice. The element refers to a **PARTY_ID** of an invoice recipient in the same document.If the document is used as a credit memo or advice of amendment (see also **INVOICE_TYPE**) the referred party of **INVOICE_RECIPIENT_IDREF** is also the supplier.

New element

INVOICE_RECIPIENT_IDREF

type

General

Used in	Default value	Data type	Field length	Lang. specific	l.chg. in ver.
ORDER_PARTIES_REFERENCE	-	dtSTRING	250	-	20v2

Attributes

Designation	Attribute name	Mandatory/optional	Explanation	Default value	Data type	Field length	Lang. specific	l.chg. in ver.
Coding standard	type	Optional	This attribute is used to state the coding standard to which the identifier (PARTY_ID) adheres. The most common coding standards are predefined. See also: Predefined values for attribute "type"	-	dtSTRING	250	-	1.2_fd

Predefined values for attribute "type"

Designation	Attribute value	Explanation	l.chg. in ver.
Buyer-specific number	buyer_specific	Identification number defined by the buyer	-
Customer specific number	customer_specific	Identification number defined by the customer	2005fd
Dun & Bradstreet	duns	DUNS-Number (see also http://dbuk.dnb.com/english/DataBase/duns.htm)	-
Global location number	iln	Internationally called GLN (see GLN below)	-
Global location number	gln	Global Location Number GLN (see also http://www.ean-int.org/locations.html)	2005fd
Party-specific number	party_specific	Identification number defined by the respective party	2005fd

Predefined values for attribute "type"

Designation	Attribute value	Explanation	l.chg. in ver.
Supplier-specific number	supplier_specific	Identification number defined by the supplier	-
Other codification standard	User defined value, format: \w{1,250}	Identifier of codification standard. "\w{1,250}" means that the identifier of the codification standard has to be at least 1 character long up to a maximum of 250 characters.	-

SHIPMENT_PARTIES_REFERENCE

(Shipment parties)

Refers to business partners integrated in the process of the goods delivery procedure.



The element replaces the element ORDER_PARTIES in combination with **PARTY**.

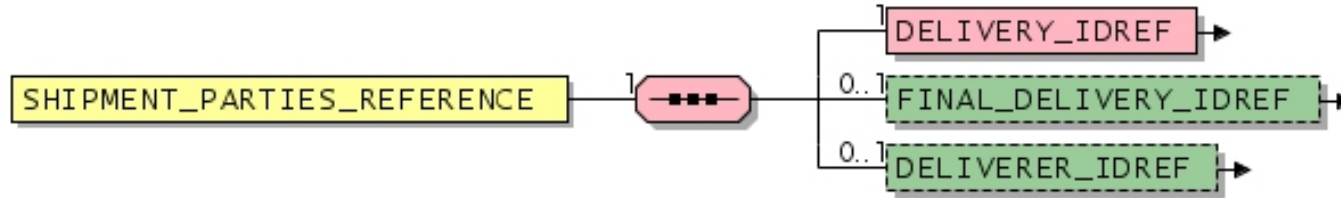

General

Used in	Default value	Data type	Field length	Lang. specific	l.chg. in ver.
ORDER_ITEM, ORDER_PARTIES_REFERENCE	-	-	-	-	20v3

Elements

Designation	Element name	Mandatory/Optional	Single/Multiple	Explanation	Default value	Data type	Field length	Lang. specific	l.chg. in ver.
Reference to final recipient	DELIVERY_IDREF - type	Mandatory	Single	Reference to the unique identifier of the final recipient (shipping address and contact). The element has to refer to a PARTY_ID in the same document. 	-	dtSTRING	250	-	20v2
Reference to a final recipient	FINAL_DELIVERY_IDREF - type	Optional	Single	Reference to a unique identifier of the final recipient. The element has to refer to a PARTY_ID in the same document. 	-	dtSTRING	250	-	20v2
Reference to a carrier	DELIVERER_IDREF - type	Optional	Single	Reference to an unique identifier of a carrier. This element has to refer to a PARTY_ID in the same document. 	-	dtSTRING	250	-	20v2

DELIVERY_IDREF

(Reference to final recipient)

Reference to the unique identifier of the final recipient (shipping address and contact). The element has to refer to a **PARTY_ID** in the same document.

New element

**General**

Used in	Default value	Data type	Field length	Lang. specific	l.chg. in ver.
SHIPMENT_PARTIES_REFERENCE	-	dtSTRING	250	-	20v2

Attributes

Designation	Attribute name	Mandatory/optional	Explanation	Default value	Data type	Field length	Lang. specific	l.chg. in ver.
Coding standard	type	Optional	This attribute is used to state the coding standard to which the identifier (PARTY_ID) adheres. The most common coding standards are predefined. See also: Predefined values for attribute "type"	-	dtSTRING	250	-	1.2_fd

Predefined values for attribute "type"

Designation	Attribute value	Explanation	l.chg. in ver.
Buyer-specific number	buyer_specific	Identification number defined by the buyer	-
Customer specific number	customer_specific	Identification number defined by the customer	2005fd
Dun & Bradstreet	duns	DUNS-Number (see also http://dbuk.dnb.com/english/DataBase/duns.htm)	-
Global location number	iln	Internationally called GLN (see GLN below)	-
Global location number	gln	Global Location Number GLN (see also http://www.ean-int.org/locations.html)	2005fd
Party-specific number	party_specific	Identification number defined by the respective party	2005fd
Supplier-specific number	supplier_specific	Identification number defined by the supplier	-
Other codification standard	User defined value, format: \w{1,250}	Identificator of codification standard. "\w{1,250}" means that the identificator of the codification standard has to be at least 1 character long up to a maximum of 250 characters.	-

FINAL_DELIVERY_IDREF

(Reference to a final recipient)

Reference to a unique identifier of the final recipient. The element has to refer to a **PARTY_ID** in the same document.

New element

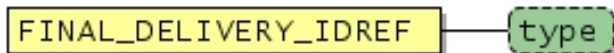
**General**

Used in	Default value	Data type	Field length	Lang. specific	l.chg. in ver.
SHIPMENT_PARTIES_REFERENCE	-	dtSTRING	250	-	20v2

Attributes

Designation	Attribute name	Mandatory/optional	Explanation	Default value	Data type	Field length	Lang. specific	l.chg. in ver.
Coding standard	type	Optional	This attribute is used to state the coding standard to which the identifier (PARTY_ID) adheres. The most common coding standards are predefined. See also: Predefined values for attribute "type"	-	dtSTRING	250	-	1.2_fd

Predefined values for attribute "type"

Designation	Attribute value	Explanation	l.chg. in ver.
Buyer-specific number	buyer_specific	Identification number defined by the buyer	-
Customer specific number	customer_specific	Identification number defined by the customer	2005fd
Dun & Bradstreet	duns	DUNS-Number (see also http://dbuk.dnb.com/english/DataBase/duns.htm)	-
Global location number	iln	Internationally called GLN (see GLN below)	-
Global location number	gln	Global Location Number GLN (see also http://www.ean-int.org/locations.html)	2005fd
Party-specific number	party_specific	Identification number defined by the respective party	2005fd
Supplier-specific number	supplier_specific	Identification number defined by the supplier	-
Other codification standard	User defined value, format: \w{1,250}	Identificator of codification standard. "\w{1,250}" means that the identificator of the codification standard has to be at least 1 character long up to a maximum of 250 characters.	-

DELIVERER_IDREF

(Reference to a carrier)

Reference to an unique identifier of a carrier. This element has to refer to a **PARTY_ID** in the same document.

New element

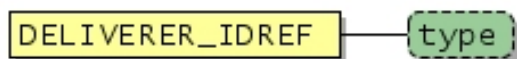
**General**

Used in	Default value	Data type	Field length	Lang. specific	l.chg. in ver.
SHIPMENT_PARTIES_REFERENCE	-	dtSTRING	250	-	20v2

Attributes

Designation	Attribute name	Mandatory/optional	Explanation	Default value	Data type	Field length	Lang. specific	l.chg. in ver.
Coding standard	type	Optional	This attribute is used to state the coding standard to which the identifier (PARTY_ID) adheres. The most common coding standards are predefined. See also: Predefined values for attribute "type"	-	dtSTRING	250	-	1.2_fd

Predefined values for attribute "type"

Designation	Attribute value	Explanation	l.chg. in ver.
Buyer-specific number	buyer_specific	Identification number defined by the buyer	-
Customer specific number	customer_specific	Identification number defined by the customer	2005fd
Dun & Bradstreet	duns	DUNS-Number (see also http://dbuk.dnb.com/english/DataBase/duns.htm)	-
Global location number	iln	Internationally called GLN (see GLN below)	-
Global location number	gln	Global Location Number GLN (see also http://www.ean-int.org/locations.html)	2005fd
Party-specific number	party_specific	Identification number defined by the respective party	2005fd
Supplier-specific number	supplier_specific	Identification number defined by the supplier	-
Other codification standard	User defined value, format: \w{1,250}	Identificator of codification standard. "\w{1,250}" means that the identificator of the codification standard has to be at least 1 character long up to a maximum of 250 characters.	-

DOCEXCHANGE_PARTIES_REFERENCE

(Document exchange parties)

The element contains references to the partners who take part in the document exchange.

The first case to use this element is when various parties like intermediators, market-places or service providers are involved in parts of the processing (especially in the case of a centralized settlement). The second case is the usage of business documents which appear in different forms where the document-flow changes.

Example:

In the case of a payment advice the roles do not specify if the payer sends the document to explain a remittance or the remittee sends the document to explain a direct debit.



New element

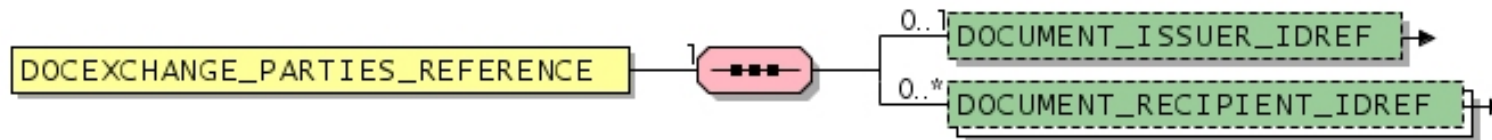

General

Used in	Default value	Data type	Field length	Lang. specific	l.chg. in ver.
ORDER_INFO	-	-	-	-	20v3

Elements

Designation	Element name	Mandatory/Optional	Single/Multiple	Explanation	Default value	Data type	Field length	Lang. specific	l.chg. in ver.
Reference to the document issuer	DOCUMENT_ISSUER_IDREF - type	Optional	Single	The element refers to a unique identifier of the initiator or issuer of the business document. The element refers to a PARTY_ID in the same document 	-	dtSTRING	250	-	20v3
Reference to the document recipient	DOCUMENT_RECIPIENT_IDREF - type	Optional	Multiple	The element refers to a unique identifier of the recipient of the business document. The element refers to a PARTY_ID in the same document 	-	dtSTRING	250	-	20v3

DOCUMENT_ISSUER_IDREF

(Reference to the document issuer)

The element refers to a unique identifier of the initiator or issuer of the business document. The element refers to a **PARTY_ID** in the same document.



New element

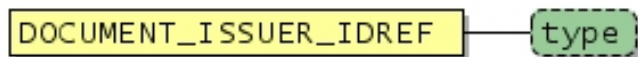

General

Used in	Default value	Data type	Field length	Lang. specific	l.chg. in ver.
DOEXCHANGE_PARTIES_REFERENCE	-	dtSTRING	250	-	20v3

Attributes

Designation	Attribute name	Mandatory/optional	Explanation	Default value	Data type	Field length	Lang. specific	l.chg. in ver.
Coding standard	type	Optional	This attribute is used to state the coding standard to which the identifier (PARTY_ID) adheres. The most common coding standards are predefined. See also: Predefined values for attribute "type"	-	dtSTRING	250	-	1.2_fd

Predefined values for attribute "type"

Designation	Attribute value	Explanation	l.chg. in ver.
Buyer-specific number	buyer_specific	Identification number defined by the buyer	-
Customer specific number	customer_specific	Identification number defined by the customer	2005fd
Dun & Bradstreet	duns	DUNS-Number (see also http://dbuk.dnb.com/english/DataBase/duns.htm)	-
Global location number	iln	Internationally called GLN (see GLN below)	-
Global location number	gln	Global Location Number GLN (see also http://www.ean-int.org/locations.html)	2005fd
Party-specific number	party_specific	Identification number defined by the respective party	2005fd
Supplier-specific number	supplier_specific	Identification number defined by the supplier	-
Other codification standard	User defined value, format: \w{1,250}	Identificator of codification standard. "\w{1,250}" means that the identificator of the codification standard has to be at least 1 character long up to a maximum of 250 characters.	-

DOCUMENT_RECIPIENT_IDREF

(Reference to the document recipient)

The element refers to a unique identifier of the recipient of the business document. The element refers to a **PARTY_ID** in the same document.



New element

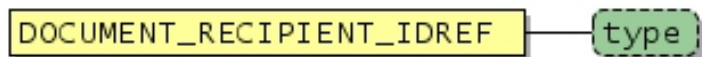

General

Used in	Default value	Data type	Field length	Lang. specific	I.chg. in ver.
DOEXCHANGE_PARTIES_REFERENCE	-	dtSTRING	250	-	20v3

Attributes

Designation	Attribute name	Mandatory/optional	Explanation	Default value	Data type	Field length	Lang. specific	I.chg. in ver.
Coding standard	type	Optional	This attribute is used to state the coding standard to which the identifier (PARTY_ID) adheres. The most common coding standards are predefined. See also: Predefined values for attribute "type"	-	dtSTRING	250	-	1.2_fd

Predefined values for attribute "type"

Designation	Attribute value	Explanation	I.chg. in ver.
Buyer-specific number	buyer_specific	Identification number defined by the buyer	-
Customer specific number	customer_specific	Identification number defined by the customer	2005fd
Dun & Bradstreet	duns	DUNS-Number (see also http://dbuk.dnb.com/english/DataBase/duns.htm)	-
Global location number	iln	Internationally called GLN (see GLN below)	-
Global location number	gln	Global Location Number GLN (see also http://www.ean-int.org/locations.html)	2005fd
Party-specific number	party_specific	Identification number defined by the respective party	2005fd
Supplier-specific number	supplier_specific	Identification number defined by the supplier	-
Other codification standard	User defined value, format: \w{1,250}	Identificator of codification standard. "\w{1,250}" means that the identificator of the codification standard has to be at least 1 character long up to a maximum of 250 characters.	-

PAYMENT

(Mode of payment)

The PAYMENT element summarizes information about the terms of payment. Exactly one term of payment must be used. If no information about payment is transferred (e.g. because this has been defined in a skeleton contract) the element is not used.

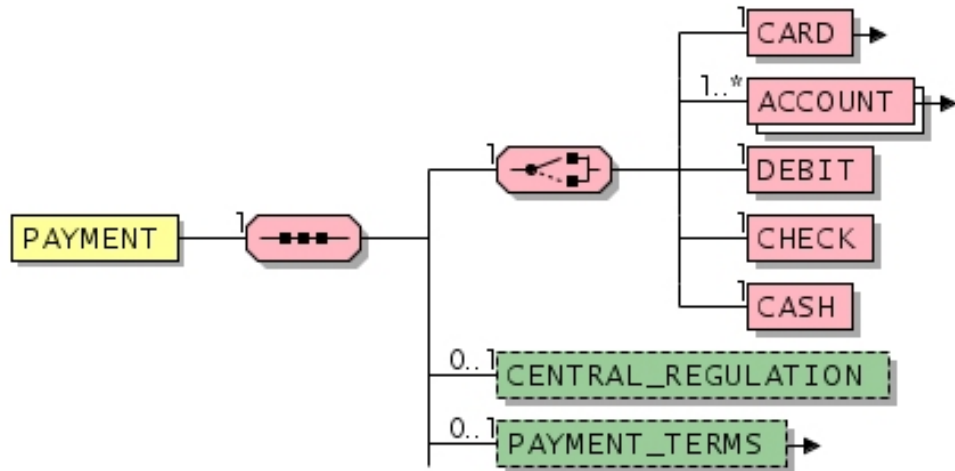





General

Used in	Default value	Data type	Field length	Lang. specific	l.chg. in ver.
ORDER_INFO	-	-	-	-	2.0

Elements

Designation	Element name	Mandatory/Optional	Single/Multiple	Explanation	Default value	Data type	Field length	Lang. specific	l.chg. in ver.
Card payment	CARD - type	Mandatory	Single	Use of credit cards, purchase cards etc. *	-	-	-	-	21fd
Bank account	ACCOUNT	Mandatory	Multiple	Bank account details *	-	-	-	-	21fd

Elements										
Designation	Element name	Mandatory/Optional	Single/Multiple	Explanation	Default value	Data type	Field length	Lang. specific	I.chg. in ver.	
Debit notification	DEBIT	Mandatory	Single	The element DEBIT specifies the credit note procedure as payment system.  The sub-element PAYMENT_TERM was moved to PAYMENT_TERMS .	-	dtBOO-LEAN	-	-	20fd	
Check payment	CHECK	Mandatory	Single	The element CHECK specifies paying by check as payment system.  The sub-element PAYMENT_TERM was moved to the element PAYMENT_TERMS .	-	dtBOO-LEAN	-	-	20fd	
Cash payment	CASH	Mandatory	Single	The element CASH specifies cash payment as payment system .  The Sub-element PAYMENT_TERM was moved to the element PAYMENT_TERMS .	-	dtBOO-LEAN	-	-	20fd	
Centralized settlement	CENTRAL_REGULATION	Optional	Single	Indicates if the payment process is transacted via a centralized settlement  New element	false	dtBOO-LEAN	-	-	20v3	
Term of payment	PAYMENT_TERMS	Optional	Single	Information to payment terms 	-	-	-	-	21	

CARD

(Card payment)

The CARD element summarizes information about payment using credit or purchasing cards.



Subelements CARD_TYPE and CARD_OTHER replaced by the type-attribute of CARD. A list of available values was added. Example added.

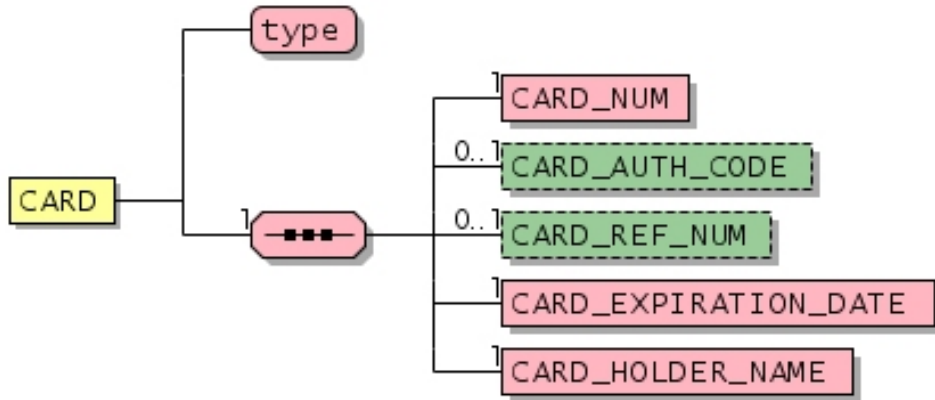

General

Used in	Default value	Data type	Field length	Lang. specific	l.chg. in ver.
PAYMENT	-	-	-	-	21fd

Attributes

Designation	Attribute name	Mandatory/optional	Explanation	Default value	Data type	Field length	Lang. specific	l.chg. in ver.
Card type	type	Mandatory	The type of the card.  New attribute See also: Predefined values for attribute "type"	-	dtSTRING	50	-	21fd

Predefined values for attribute "type"

Designation	Attribute value	Explanation	l.chg. in ver.
MasterCard	MasterCard	MasterCard	21fd
VISA	VISA	VISA	21fd
American Express	AmericanExpress	American Express	21fd
Diners Club	DinersClub	Diners Club	21fd
JCB	JCB	JCB	21fd
Maestro	Maestro	Maestro	21fd
DiscoverCard	DiscoverCard	Discover Card	21fd
Transcard	Transcard	Transcard	21fd
DinaCard	DinaCard	DinaCard	21fd
ChinaUnionPay	ChinaUnionPay	China UnionPay	21fd
User-defined value	User defined value, format: \w{1,50}	Any other or future Hash-function in format \w{1,50}. Regular Expression valid for any letter or number excluding whitespaces.	21fd

Elements

Designation	Element name	Mandatory/Optional	Single/Multiple	Explanation	Default value	Data type	Field length	Lang. specific	l.chg. in ver.
Card number	CARD_NUM	Mandatory	Single	Number of the credit or purchasing card	-	dtSTRING	16	-	2.0
PIN	CARD_AUTH_CODE	Optional	Single	 (Caution! - not recommended for use for insecure transmission!)	-	dtSTRING	10	-	2.0
Reference number	CARD_REF_NUM	Optional	Single	Customer reference number	-	dtSTRING	50	-	2.0
Expiration date	CARD_EXPIRATION_DATE	Mandatory	Single	Expiration date Example: "2001-03" for 03/2001	-	dtDATETIME	-	-	2.0
Card holder	CARD HOLDER_NAME	Mandatory	Single	Name of the card holder the credit card has been issued to.	-	dtSTRING	50	-	2.0

Example

```
<CARD type="VISA">
  <CARD_NUM>111222333444</CARD_NUM>
  <CARD_EXPIRATION_DATE>2009-05</CARD_EXPIRATION_DATE>
  <CARD HOLDER_NAME>Supershop Store International</CARD HOLDER_NAME>
</CARD>
```

PAYMENT_TERMS

(Term of payment)

Information to payment terms



New element
Example added.

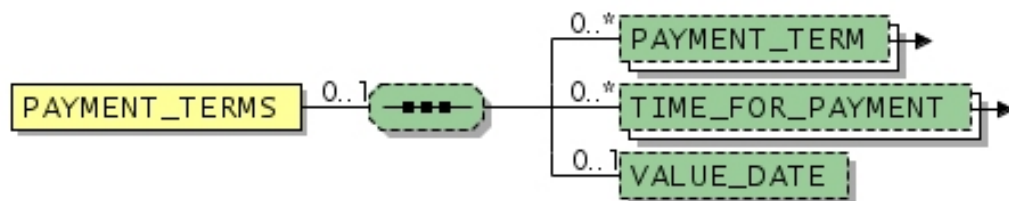

General

Used in	Default value	Data type	Field length	Lang. specific	l.chg. in ver.
PAYMENT	-	-	-	-	21

Elements

Designation	Element name	Mandatory/Optional	Single/Multiple	Explanation	Default value	Data type	Field length	Lang. specific	l.chg. in ver.
Term of payment	PAYMENT_TERM - type	Optional	Multiple	The information can be given according to UN/ECE or be company-specific.	-	dtSTRING	250	-	2.0
Time for payment	TIME_FOR_PAYMENT	Optional	Multiple	Information to time-related payment details like period for payment, early payment discounts 	-	-	-	-	21
Value date	VALUE_DATE	Optional	Single	Specifies the value date. If the time for payment are not specified using TIME_FOR_PAYMENT or only the DAYS are specified then the period of payment begins at this VALUE_DATE . Is the PAYMENT_DATE used then the element PAYMENT_DATE is decisive. New element The description of VALUE_DATE has been extended and an example has been added.	-	dtDATETIME	-	-	21

Example

Specification of the following details: time for payment is 30 days, 3% early payment discount for payment in a 10 day period, 1% early payment discount for payment within a 20 day period. The value-date states the beginning of the payment period by May 15th, 2009.

```
<PAYMENT_TERMS>
  <TIME_FOR_PAYMENT>
    <DAYS>30</DAYS>
  </TIME_FOR_PAYMENT>
  <TIME_FOR_PAYMENT>
    <DAYS>10</DAYS>
    <DISCOUNT_FACTOR>0.3</DISCOUNT_FACTOR>
  </TIME_FOR_PAYMENT>
  <TIME_FOR_PAYMENT>
    <DAYS>20</DAYS>
    <DISCOUNT_FACTOR>0.1</DISCOUNT_FACTOR>
  </TIME_FOR_PAYMENT>
  <VALUE_DATE>2009-05-15</VALUE_DATE>
</PAYMENT_TERMS>
```

PAYMENT_TERM

(Term of payment)

The information can be given according to UN/ECE or be company-specific.

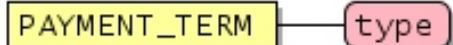
**General**

Used in	Default value	Data type	Field length	Lang. specific	l.chg. in ver.
PAYMENT_TERMS	-	dtSTRING	250	-	2.0

Attributes

Designation	Attribute name	Mandatory/optional	Explanation	Default value	Data type	Field length	Lang. specific	l.chg. in ver.
Term of payment	type	Mandatory	Procedure according to which the term of payment is coded. See also: Permitted values for attribute "type"	-	dtSTRING	20	-	2.0

Permitted values for attribute "type"

Designation	Attribute value	Explanation	l.chg. in ver.
UN/ECE	unece	Description of the term of payment according to UN/ECE convention 4279. (see http://www.unece.org/trade/untid/d00b/tred/tred4279.htm)	-
Other	other	Means that there is no descriptive procedure to be used for the term of payment but a free text instead.	-

TIME_FOR_PAYMENT

(Time for payment)

The element contains information to time-related payment details like period for payment, early payment discounts. For specifying the period of payment the element **PAYMENT_DATE** (to set a date) or the element **DAYS** (to set a time-frame) can be used.

In the case of no further specification of details the specified period for payment is the "net time for payment". The sub-element **DISCOUNT_FACTOR** specifies the factor used for a early payment discount. If the element **ALLOW_OR_CHARGES_FIX** is used any surcharges or discounts can be used (e.g. early payment discounts or late fees for exceeding the deadline for payment).



New element

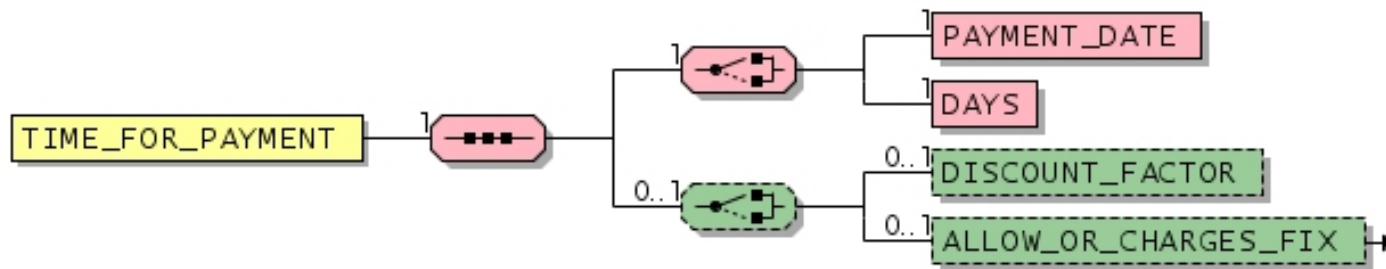

Example changed and additional example added.





General

Used in	Default value	Data type	Field length	Lang. specific	l.chg. in ver.
PAYMENT_TERMS	-	-	-	-	21

Elements

Designation	Element name	Mandatory/Optional	Single/Multiple	Explanation	Default value	Data type	Field length	Lang. specific	l.chg. in ver.
Time for payment	PAYMENT_DATE	Mandatory	Single	Time where the payment is supposed to be done.  New element	-	dtDATE-TIME	-	-	20v2
Days	DAYS	Mandatory	Single	Time designation by days  New element	-	dtCOUNT	-	-	20fd

Elements

Designation	Element name	Mandatory/Optional	Single/Multiple	Explanation	Default value	Data type	Field length	Lang. specific	l.chg. in ver.
Cash discount factor	DISCOUNT_FACTOR	Optional	Single	Factor to calculate the cash discount, e.g. 0.3 means 3% cash discount  New element	-	dtFLOAT	-	-	20fd
Fixed allowance or surcharges	ALLOW_OR_CHARGES_FIX	Optional	Single	A list of fixed allowances or surcharges which are to be applied on the price. 	-	-	-	-	21fd

Example

Specification of the following details: time for payment is May 30th, 3% early payment discount for payment until May 10th, 1% early payment discount for payment until May 20th. (see also **PAYMENT_TERMS** for an additional example)

```

<PAYMENT_TERMS>
  <TIME_FOR_PAYMENT>
    <PAYMENT_DATE>2009-05-30</PAYMENT_DATE>
  </TIME_FOR_PAYMENT>
  <TIME_FOR_PAYMENT>
    <PAYMENT_DATE>2009-05-20</PAYMENT_DATE>
    <DISCOUNT_FACTOR>0.1</DISCOUNT_FACTOR>
  </TIME_FOR_PAYMENT>
  <TIME_FOR_PAYMENT>
    <PAYMENT_DATE>2009-05-10</PAYMENT_DATE>
    <DISCOUNT_FACTOR>0.3</DISCOUNT_FACTOR>
  </TIME_FOR_PAYMENT>
</PAYMENT_TERMS>

```

ALLOW_OR_CHARGES_FIX

(Fixed allowance or surcharges)

A list of fixed allowances or surcharges which are to be applied on the price.



New element
Example added.

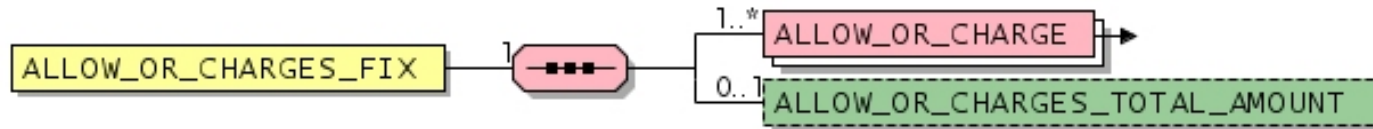

General

Used in	Default value	Data type	Field length	Lang. specific	l.chg. in ver.
PRODUCT_PRICE_FIX, TIME_FOR_PAYMENT	-	-	-	-	21fd

Elements

Designation	Element name	Mandatory/Optional	Single/Multiple	Explanation	Default value	Data type	Field length	Lang. specific	l.chg. in ver.
Fixed charge or allowance	ALLOW_OR_CHARGE - type	Mandatory	Multiple	Description of a fixed surcharge or allowance. Please notice the usage-advice at ALLOW_OR_CHARGE . 	-	-	-	-	21
Total amount of the allowances and surcharges	ALLOW_OR_CHARGES_TOTAL_AMOUNT	Optional	Single	Sum of all allowances and surcharges which lead to a monetary amount. Only those allowances and surcharges are considered which have a real amount (AOC_MONETARY_AMOUNT) in ALLOW_OR_CHARGE_VALUE or can be calculated via a percentage (AOC_PERCENTAGE_FACTOR). New element	-	dtFLOAT	-	-	20v1

Example

```
<ALLOW_OR_CHARGES_FIX>  
  <ALLOW_OR_CHARGE type="allowance">  
    <ALLOW_OR_CHARGE_TYPE>rebate</ALLOW_OR_CHARGE_TYPE>  
    <ALLOW_OR_CHARGE_VALUE>  
      <AOC_PERCENTAGE_FACTOR>10.00</AOC_PERCENTAGE_FACTOR>  
    </ALLOW_OR_CHARGE_VALUE>  
  </ALLOW_OR_CHARGE>  
  <ALLOW_OR_CHARGES_TOTAL_AMOUNT>120</ALLOW_OR_CHARGES_TOTAL_AMOUNT>  
</ALLOW_OR_CHARGES_FIX>
```

ALLOW_OR_CHARGE

(Fixed charge or allowance)

Description of a fixed surcharge or allowance.  Caution: Please ensure that the allowances and charges are only used at allowed document positions. E.g. cash_discounts should be used only in **PAYMENT_TERMS**



New element

Description more detailed.

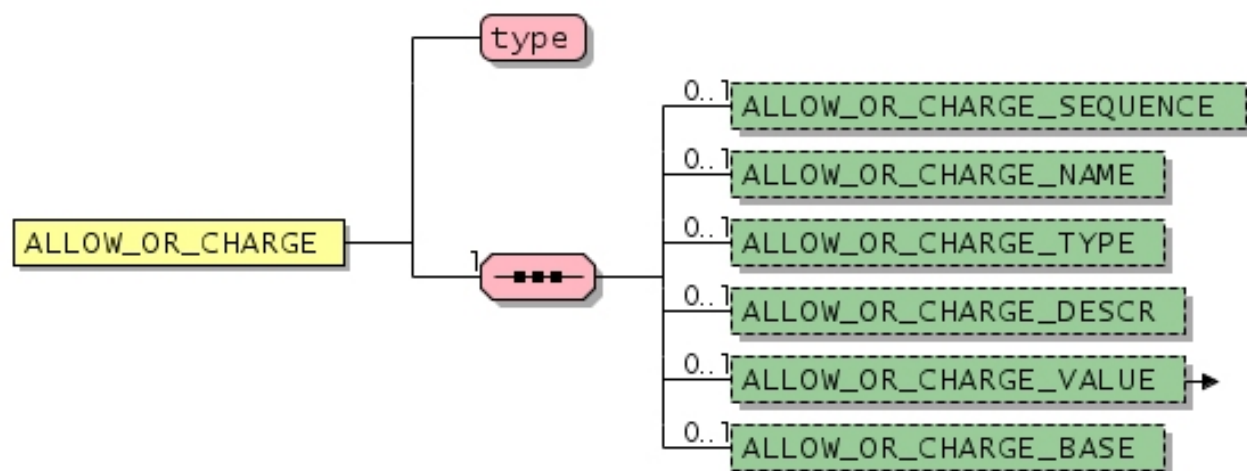

General

Used in	Default value	Data type	Field length	Lang. specific	l.chg. in ver.
ALLOW_OR_CHARGES_FIX	-	-	-	-	21





Attributes

Designation	Attribute name	Mandatory/optional	Explanation	Default value	Data type	Field length	Lang. specific	l.chg. in ver.
Allowance or surcharge	type	Mandatory	Indicates if the element is about an allowance or a surcharge.  New attribute See also: Permitted values for attribute "type"	-	dtSTRING	-	-	20v3

Permitted values for attribute "type"

Designation	Attribute value	Explanation	l.chg. in ver.
Allowance	allowance	The element is about an allowance.	20v3
Surcharge	surcharge	The element is about a surcharge.	20v3

Elements

Designation	Element name	Mandatory/Optional	Single/Multiple	Explanation	Default value	Data type	Field length	Lang. specific	l.chg. in ver.
Calculation sequence	ALLOW_OR_CHARGE_SEQUENCE	Optional	Single	This element indicates the sequence for the application of the allowance or surcharge on the amount. The allowances or surcharges are applied in ascending order of the value of the element ALLOW_OR_CHARGE_SEQUENCE . That means the allowance or surcharge with the lowest value are applied first to the original amount or (if available) to the ALLOW_OR_CHARGE_BASE . Afterwards the surcharges are being added and the allowances are subtracted and the surcharges of the next higher value are determined based on the new calculated amount.	-	dtCOUNT	-	-	2.0v1
Allowance or surcharge-name	ALLOW_OR_CHARGE_NAME	Optional	Single	Short name for the allowance or surcharge (e.g. freight, packaging, ...)  New element	-	dtML-STRING	80	Yes	20v1
Allowance or surcharge-type	ALLOW_OR_CHARGE_TYPE	Optional	Single	Typification of the type of the allowance or surcharge (e.g. freight, postage and packing, ...).  New element See also: Predefined values for element ALLOW_OR_CHARGE_TYPE	-	dtSTRING	30	-	20v1
Allowance or surcharge description	ALLOW_OR_CHARGE_DESCR	Optional	Single	Textual description of the allowance or surcharge. This element can be used to supply additional information about the allowance or surcharge-reason. Examples: In case of island-surcharges the name of the island can be quoted here or the contract reference in case of project reimbursements.  New element	-	dtML-STRING	250	Yes	20v1
Allowance or surcharge value	ALLOW_OR_CHARGE_VALUE	Optional	Single	Description of the structure of the allowance or surcharge  New element	-	-	-	-	20v1
Allowance or surcharge-base	ALLOW_OR_CHARGE_BASE	Optional	Single	If declared, this element is the calculation base for the allowance or surcharge instead of the original value or the previous allowance or surcharge-calculations.  New element	-	dtFLOAT	-	-	20v2

Predefined values for element ALLOW_OR_CHARGE_TYPE

Designation	Element value	Explanation	l.chg. in ver.
Abroad	abroad	Abroad	20v2
Administration	administration	Administration	20v2
bulky goods	bulk_goods	bulky goods	20v2
Cash discount	cash_discount	Cash discount	20v2
Surcharge	charge	Surcharge	20v2
Cash on delivery	cod	C.O.D. cash on delivery service	20v2
Customs	customs	Customs	20v2
Customization	customization	Customization	20v3
Deposit	deposit	Deposit	20v2
Express	express	Express	20v2
Freight	freight	Freight	20v2
Handling	handling	Handling	20v2
Insurance	insurance	Insurance	20v2
Extra isle-charge	island	Surcharge for islands.	20v2
Surcharge for material	material	Surcharge for material	20v2
Packing	packing	Packing	20v2
Partial Quantity	partial_quantity	Partial Quantity	20v2
Period-bonus	period_bonus	Period-bonus (e.g. annual bonus)	20v2
Postage	postage	Postage	20v2
Project-bonus	project_bonus	Project-bonus	20v2
	overpackaging		-
Rebate	rebate	Rebate	20v2
Recycling	recycling	Recycling	20v2
Minimum quantity surcharge	small_order	Minimum quantity surcharge	20v2

Predefined values for element ALLOW_OR_CHARGE_TYPE

Designation	Element value	Explanation	l.chg. in ver.
Sundays, public holidays or night work	special_work_times	Sundays, public holidays or night work	20v2
Toll	toll	Toll	20v2
User defined type	User defined value, format: [w\-.]{1,30}	You can use any allowance or surcharge-types. The individual meaning has to be clarified between the partners. "\w{1,30}" means that the name of a type has to be at least one character and be 20 characters in maximum.	-

ALLOW_OR_CHARGE_VALUE

(Allowance or surcharge value)

A description of the structure of the allowance or surcharge. The type is defined in the related sub-element. Both allowances and surcharges are positiv values. The attribute **ALLOW_OR_CHARGE -->type** indicates an allowance or surcharge and thus indicates an increase or decrease of the original amount.



New element

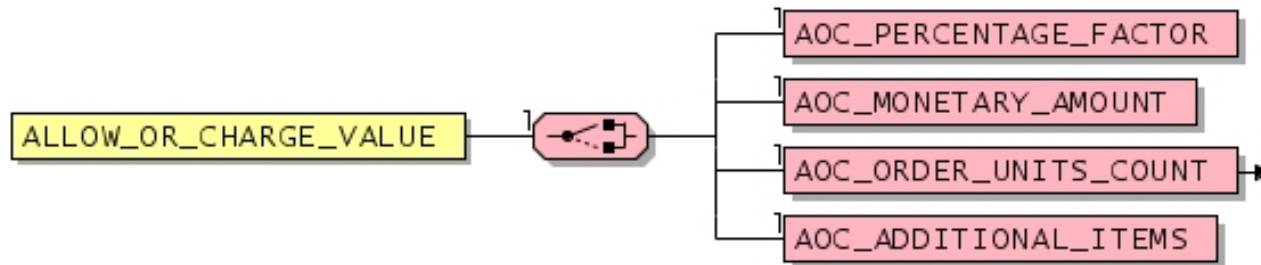



General

Used in	Default value	Data type	Field length	Lang. specific	l.chg. in ver.
ALLOW_OR_CHARGE	-	-	-	-	20v1

Elements

Designation	Element name	Mandatory/Optional	Single/Multiple	Explanation	Default value	Data type	Field length	Lang. specific	l.chg. in ver.
Prozentual Value	AOC_PERCENTAGE_FACTOR	Mandatory	Single	The share of the product-value (factor) to determine the allowance or charge. The allowance or charge is calculated by multiply the AOC_PERCENTAGE_FACTOR by the (interim-)product-value which was calculated at this stage of the document. The currency is not different to the currency of the product-price. New element	-	dtFLOAT	-	-	20v1
Monetary amount	AOC_MONETARY_AMOUNT	Mandatory	Single	The allowance or charge is defined via an absolut value. The currency is identical with the product price currency. New element	-	dtFLOAT	-	-	20v1

Elements										
Designation	Element name	Mandatory/ Optional	Single/ Multiple	Explanation	Default value	Data type	Field length	Lang. specific	I.chg. in ver.	
Number of rebates in kind units	AOC_ORDER_UNITS_COUNT - type	Mandatory	Single	Number of rebates or charge in kind units 	-	-	-	-	20v1	
Additional Items	AOC_ADDITIONAL_ITEMS	Mandatory	Single	Declaration if additional items are delivered. This field can is only permitted in case of be intended for other items than the items of the parent-product and -order-unit (ORDER_UNIT). In case of the same product the field AOC_ORDER_UNITS_COUNT has to be used.  New element	-	dtSTRING	250	-	20v1	

AOC_ORDER_UNITS_COUNT

(Number of rebates in kind units)

The number of rebates or charges in kind units indicates the number of units which are delivered for free. The attribute **AOC_ORDER_UNITS_COUNT -->type** indicates a bonus or an additional charge.



New element

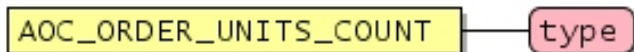

General

Used in	Default value	Data type	Field length	Lang. specific	l.chg. in ver.
ALLOW_OR_CHARGE_VALUE	-	-	-	-	20v1

Attributes

Designation	Attribute name	Mandatory/optional	Explanation	Default value	Data type	Field length	Lang. specific	l.chg. in ver.
Type of the rebate in kind	type	Mandatory	Indicates a bonus or an additional unit. See also: Permitted values for attribute "type"	-	dtSTRING	20	-	-

Permitted values for attribute "type"

Designation	Attribute value	Explanation	l.chg. in ver.
Bonus (bonus included in order)	inclusive	The specified units are give-aways and are subtracted from the ordered quantity (QUANTITY) while the total amount is being calculated.	-
Extra Bonus (bonus excluded from order)	exclusive	The specified units are an extra bonus in addition to the ordered QUANTITY .	-

TRANSPORT

(Transport) namespace: BMECAT

This element contains information about the terms of transport.



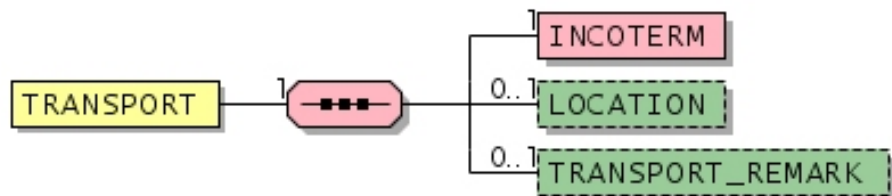

New element



General

Used in	Default value	Data type	Field length	Lang. specific	l.chg. in ver.
ORDER_INFO, ORDER_ITEM	-	-	-	-	2005fd

Elements

Designation	Element name	Mandatory/Optional	Single/Multiple	Explanation	Default value	Data type	Field length	Lang. specific	l.chg. in ver.
INCOTERM	INCOTERM	Mandatory	Single	International coding of transport, costs and insurance according to INCOTERMS 2000, UN/ECE, Recommendation No.5 (ECE/TRADE/259), (see http://www.unece.org/cefact/recommendations/rec05/rec05_ecetrd259.pdf). namespace: BMECAT  New element	-	dtSTRING	3	-	2005fd
Location of goods transfer	LOCATION	Optional	Single	Transfer of the goods from supplier to buyer or vice versa. Dependent on INCOTERM . namespace: BMECAT  New element	-	dtSTRING	250	-	2005fd
Remark	TRANSPORT_REMARK	Optional	Single	Remark concerning the type of transport. namespace: BMECAT  New element	-	dtML-STRING	64000	Yes	2005fd

INTERNATIONAL_RESTRICTIONS

(International delivery restrictions) *namespace: BMECAT*

This element contains details of international restrictions, e.g. compulsory import / export authorization.



New element

INTERNATIONAL_RESTRICTIONS

type

General

Used in	Default value	Data type	Field length	Lang. specific	l.chg. in ver.
ORDER_INFO, ORDER_ITEM	-	dtSTRING	250	-	2005fd

Attributes

Designation	Attribute name	Mandatory/optional	Explanation	Default value	Data type	Field length	Lang. specific	l.chg. in ver.
Type of restriction	type	Mandatory	Specifies the type of international delivery restriction. See also: Predefined values for attribute "type"	-	dtSTRING	50	-	2005fd

Predefined values for attribute "type"

Designation	Attribute value	Explanation	l.chg. in ver.
EU-embargo	eu-embargo	The embargo is an embargo by the European Union.	2005fd
National	national	The delivery restriction is valid nationally.	2005fd
UN-embargo	un-embargo	The embargo is an embargo by the United Nations.	2005fd
US-embargo	us-embargo	The embargo is a US-American delivery restriction.	2005fd
WTO-embargo	wto-embargo	This is a case of an embargo by the World Trade Organization.	2005fd
Other	other	This is a different delivery limitation.	2005fd
User defined type	User defined value, format: [w\-.]{1,50}	Identification of the user defined type . "w{1,50}" means that the type identification has to be at least 1 character long up to a maximum of 50 characters.	2005fd

REMARKS

(Remark)

This element contains remarks related to a business document.

The remark is identified with the attribute "type" for use in different business documents.

It is only permissible to identify remarks for use in this or the following business documents using the attribute "type".

Target systems are recommended to ignore remarks about previous business documents (History).

It is permissible to use the element more than once with the same "type" attribute.

Format: The following HTML tags are supported: for bold, <i> for italic, <p> for paragraphs,
 for line break and / for lists. In order to transfer these, the characters '<' and '>' must be enclosed in quotation marks, or the file will not be accepted by the XML parser (see also chapter **Character encoding in XML**).

Example: '<' = < or '>' = >



The target system must support the interpretation of the day in order to achieve the desired formatting.



General

Used in	Default value	Data type	Field length	Lang. specific	l.chg. in ver.
ORDER_INFO, ORDER_ITEM	-	dtML-STRING	64000	Yes	-

Attributes

Designation	Attribute name	Mandatory/optional	Explanation	Default value	Data type	Field length	Lang. specific	l.chg. in ver.
Type of remark	type	Optional	<p>Specifies the type of remark. The remark is identified for use in a variety of business documents. The business partner processing the document which matches the attribute evaluates the information contained, otherwise the information is passed on along the process chain.</p> <p>Example: type=deliverynote means that the remark entered appears on the delivery note , e.g. "Please ring at the ramp and ask for Mr Miller".</p> <p> New attribute</p> <p>See also: Predefined values for attribute "type"</p>	-	dtSTRING	250	-	2005fd

Predefined values for attribute "type"

Designation	Attribute value	Explanation	l.chg. in ver.
Delivery note	deliverynote	The remark is identified for use in the business document DELIVERYNOTE (general presumption that the delivery note currently exists in paper form only, as document accompanying the goods)	2005fd
Dispatch notification	dispatchnotification	The remark is identified for use in the business document DISPATCHNOTIFICATION	2005fd
General	general	The remark contained is of a general kind and not limited to usage in a specific business document.	2005fd
Invoice	invoice	The remark is identified for use in the business document INVOICE	2005fd
Order	order	The remark is identified for use in the business document ORDER	2005fd
Order change	orderchange	The remark is identified for use in the business document ORDERCHANGE	2005fd
Order response	orderresponse	The remark is identified for use in the business document ORDERRESPONSE	2005fd
Quotation	quotation	The remark is identified for use in the business document QUOTATION	2005fd
Confirmation of receipt of goods	receiptacknowledgement	The remark is identified for use in the business document RECEIPTACKNOWLEDGEMENT	2005fd
Payment advice	remittanceadvice	The remark is identified for use in the business document REMITTANCEADVICE	20v3
Invoice list	invoicelist	The remark is identified for use in the business document INVOICELIST	20v3
Request for submission of quotation	rfq	The remark is identified for use in the business document RFQ	2005fd
Transport	transport	The remark is identified for use in the business document TRANSPORT	2005fd
User defined type	User defined value, format: \w{1,250}	User defined type identification. "\w{1,250}" means that the type identification has to be at least 1 character long up to a maximum of 250 characters.	2005fd

ORDER_ITEM_LIST

(Item level)

The element ORDER_ITEM_LIST represents the lists of items in the order. The ORDER_ITEM_LIST is made up of individual order items.

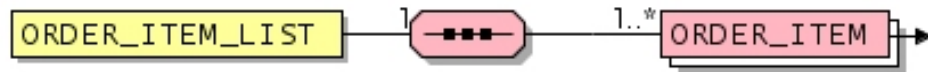

General

Used in	Default value	Data type	Field length	Lang. specific	l.chg. in ver.
ORDER	-	-	-	-	2.0

Elements

Designation	Element name	Mandatory/Optional	Single/Multiple	Explanation	Default value	Data type	Field length	Lang. specific	l.chg. in ver.
Item line	ORDER_ITEM	Mandatory	Multiple	The item line contains order information about exactly one item *	-	-	-	-	21

ORDER_ITEM

(Item line)

A item line contains order information about exactly one item. Any number of item lines can be used, although at least one item line must be used.



Example added.



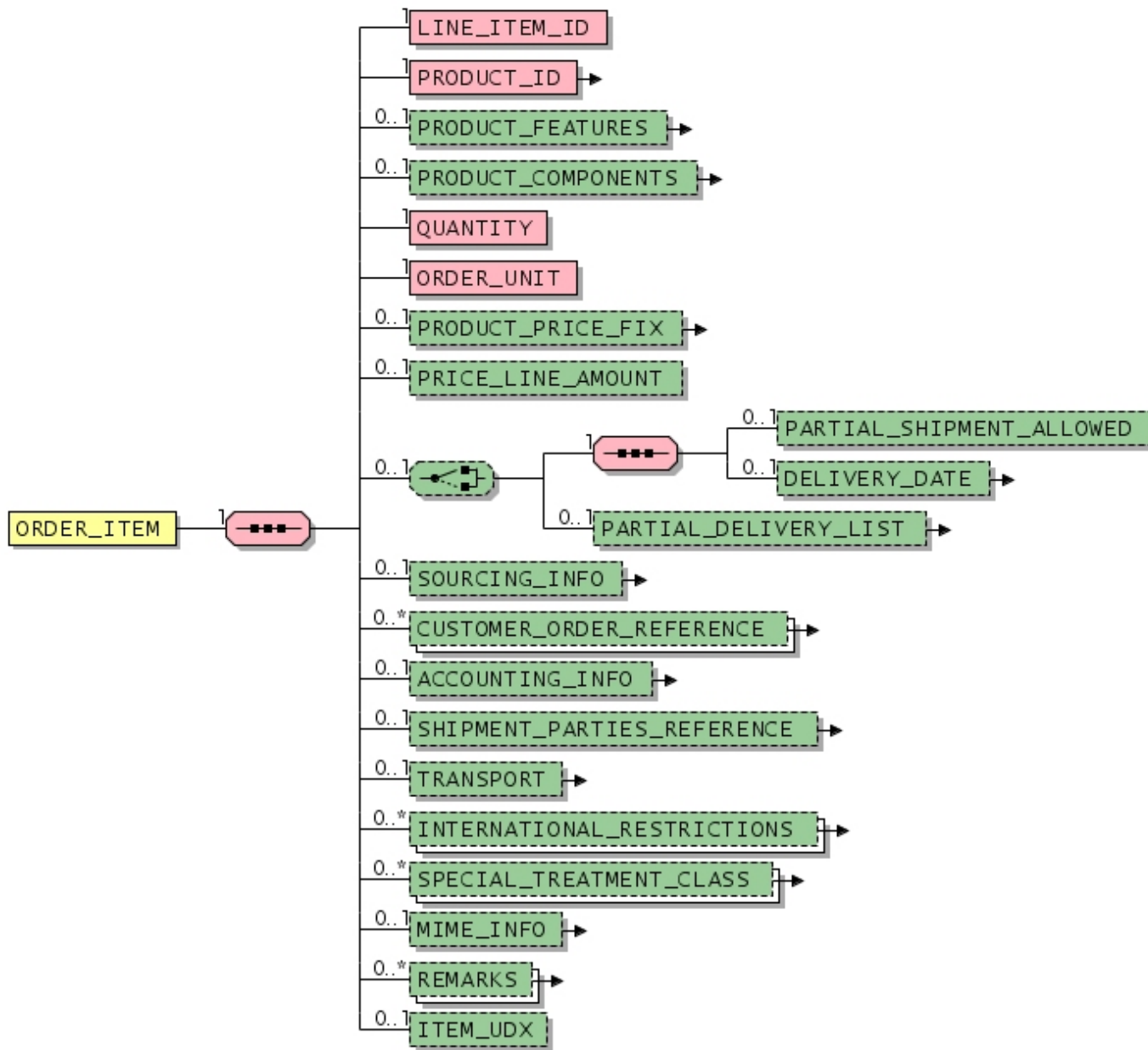

The opportunity of partial deliveries has been integrated. Due to this change the sorting of the elements has been changed to be structural equal to the other business documents like ORDERRESPONSE.









General

Used in	Default value	Data type	Field length	Lang. specific	l.chg. in ver.
ORDER_ITEM_LIST	-	-	-	-	21

Elements



Designation	Element name	Mandatory/Optional	Single/Multiple	Explanation	Default value	Data type	Field length	Lang. specific	l.chg. in ver.
Item number	LINE_ITEM_ID	Mandatory	Single	The item ID number is used to uniquely identify the item line of an order within that order. In combination with the order number and the buyer the item number represents a unique ID number outside the business process concerned. Example.: P100012	-	dtSTRING	50	-	2.0
Product number	PRODUCT_ID	Mandatory	Single	Identifier of the product. The included elements ensure the capability of a unique identification of a product. 	-	-	-	-	21fd
Product features	PRODUCT_FEATURES	Optional	Single	Description of the product by features and/or classification of the product 	-	-	-	-	21fd
Product components	PRODUCT_COMPONENTS	Optional	Single	List of product components contained in a product. 	-	-	-	-	21fd
Quantity	QUANTITY	Mandatory	Single	Quantity	-	dtNUMBER	-	-	2.0
Order unit	ORDER_UNIT	Mandatory	Single	Unit in which the product can be ordered; it is only possible to order multiples of the product unit. The price also always refers to this unit (or to part of or multiples of it). Example: Crate of mineral water with 6 bottles Order unit: "crate", contents unit/unit of the article: "bottle" Packing quantity: "6" <i>namespace: BMECAT</i>	-	dtPUNIT	-	-	-
Determined product price	PRODUCT_PRICE_FIX	Optional	Single	A fixed product price 	-	-	-	-	20v1
Total price of the position	PRICE_LINE_AMOUNT	Optional	Single	The total price of the item-line. In the normal case the value results from multiplying PRICE_AMOUNT and QUANTITY but has to be explicitly quoted. The element PRICE_LINE_AMOUNT can result from multiplying PRICE_AMOUNT and PRICE_UNIT_VALUE if the price is not connected to the ordered unit but to another price-unit. See PRICE_BASE_FIX for details.	-	dtNUMBER	-	-	-

Elements

Designation	Element name	Mandatory/ Optional	Single/ Multiple	Explanation	Default value	Data type	Field length	Lang. specific	l.chg. in ver.
Partial shipment allowed	PARTIAL_SHIPMENT_ALLOWED	Optional	Single	<p>Flag to indicate whether partial shipment is allowed. If allowed the value is TRUE, FALSE otherwise. The flag is binding for the order, i.e. if the value is set to FALSE and only partial shipments can be made by the recipient of the order, the order shall be invalid. Additionally one can provide concrete dates for the shipment.</p> <p>In contrast to the general possibility for partial shipments one can use the element PARTIAL_DELIVERY_LIST for concrete dates for partial shipments. In this case the element PARTIAL_SHIPMENT_ALLOWED is not used.</p> <p> If the element is used in the context ORDER_HEADER, the element must not be used on item level ORDER_ITEM.</p>	-	dtBOOLEAN	-	-	2.0
Delivery date	DELIVERY_DATE - type	Optional	Single	<p>Date of shipment. The delivery date specifies the date the commissioned goods are accepted by the buyer. If the delivery date deviates from the one specified in the header, the delivery date on item level is valid. To specify exact one date for the shipment, e.g. in the RECEIPTACKNOWLEDGEMENT-document, both sub-elements the DELIVERY_DATE and the DELIVERY_END_DATE should be the equal.</p> <p></p>	-	-	-	-	21fd
Partial shipment list	PARTIAL_DELIVERY_LIST	Optional	Single	<p>Information related to items of outstanding partial shipments</p> <p></p>	-	-	-	-	20v2
Sourcing information	SOURCING_INFO	Optional	Single	<p>Information about previous quotations, catalog references, skeleton agreements.</p>	-	-	-	-	2.0
Customer order reference	CUSTOMER_ORDER_REFERENCE	Optional	Multiple	<p>The element is related to an item and refers to the previous order where the item was ordered by the customer (purchasing party)</p> <p></p>	-	-	-	-	20v3
Accounting information	ACCOUNTING_INFO	Optional	Single	<p>Information on the accounting treatment of costs incurred by the buyer as a result of the order. This information is supplied by the buyer to allow the supplier to include it in the following invoice, thereby making invoice verification by the buyer easier. <i>namespace: BMECAT</i></p> <p></p>	-	-	-	-	2005fd
Shipment parties	SHIPMENT_PARTIES_REFERENCE	Optional	Single	<p>Refers to business partners integrated in the process of the goods delivery procedure.</p> <p></p>	-	-	-	-	20v3
Transport	TRANSPORT	Optional	Single	<p>Information about the terms of transport <i>namespace: BMECAT</i></p> <p></p>	-	-	-	-	2005fd

Elements

Designation	Element name	Mandatory/ Optional	Single/ Multiple	Explanation	Default value	Data type	Field length	Lang. specific	I.chg. in ver.
International delivery restrictions	INTERNATIONAL_RESTRICTIONS - type	Optional	Multiple	Details of international restrictions, e.g. compulsory import / export authorization. <i>namespace: BMECAT</i> 	-	dtSTRING	250	-	2005fd
Special treatment class	SPECIAL_TREATMENT_CLASS - type	Optional	Multiple	Additional product classification used for hazardous goods or substances, primary pharmaceutical products, radioactive measuring equipment, etc. The "type" attribute specifies the dangerous goods classification scheme. <i>namespace: BMECAT</i>	-	dtSTRING	20	-	-
Additional multimedia information	MIME_INFO	Optional	Single	Information about multimedia files	-	-	-	-	-
Remark	REMARKS - type	Optional	Multiple	Remark related to a business document	-	dtML-STRING	64000	Yes	-

Elements										
Designation	Element name	Mandatory/Optional	Single/Multiple	Explanation	Default value	Data type	Field length	Lang. specific	I.chg. in ver.	
User-defined extension	ITEM_UDX	Optional	Single	<p>This element can be used for transferring information in user-defined non-openTRANS-elements; hence it is possible to extend the pre-defined set of openTRANS-elements by user-defined ones. The usage of those elements results in openTRANS business documents, which can only be exchanged between the companies that have agreed on these extensions. The structure of these elements can be very complex, though it must be valid XML.</p> <p> <User Defined Extensions> are defined exclusively as optional fields. Therefore, it is expressly pointed out that if user-defined extensions are used they must be compatible with the target systems and should be clarified on a case-to-case basis.</p> <p>The names of the elements must be clearly distinguishable from the names of other elements contained in the openTRANS standard. For this reason, all element must start with the string "UDX" (Example: <UDX.supplier.elementname>).</p> <p>The definition of user-defined extensions takes place by additional XML DTD or XML Schema files.</p> <p> New element</p> <p>Example: usage of the non-openTRANS elements (XML)</p> <pre> <HEADER> <CATALOG> ... </CATALOG> ... <USER_DEFINED_EXTENSIONS> <UDX.MYORG.REBATEGROUP>A1</UDX.MYORG.REBATEGROUP> <UDX.MYORG.REBATEFACTOR>0.13</UDX.MYORG.REBATEFACTOR> </USER_DEFINED_EXTENSIONS> </HEADER> </pre>	-	udxITEM	-	-	20v1	

Example

```

<ORDER_ITEM>
  <LINE_ITEM_ID>1</LINE_ITEM_ID>
  <PRODUCT_ID>
    <bmecat:SUPPLIER_PID>NB-A4</bmecat:SUPPLIER_PID>
    <bmecat:DESCRIPTION_SHORT>Notebook, Black</bmecat:DESCRIPTION_SHORT>
    <bmecat:DESCRIPTION_LONG>Notebook incl. Einsteinium-CPU, 256 GB RAM and 1024 TB Harddrive</bmecat:DESCRIPTION_LONG>
  </PRODUCT_ID>
  <PRODUCT_FEATURES>
    <FEATURE>
      <bmecat:FNAME>Colour</bmecat:FNAME>
      <bmecat:FVALUE>Black</bmecat:FVALUE>
      <bmecat:FVALUE_DETAILS>Super-Dark</bmecat:FVALUE_DETAILS>
    </FEATURE>
    <FEATURE>
      <bmecat:FNAME>Weight</bmecat:FNAME>
      <bmecat:FVALUE>1</bmecat:FVALUE>
      <bmecat:FUNIT>KG</bmecat:FUNIT>
      <bmecat:FDESCR>Weight is including accumulator.</bmecat:FDESCR>
    </FEATURE>
  </PRODUCT_FEATURES>
  <PRODUCT_COMPONENTS>
    <PRODUCT_COMPONENT>
      <PRODUCT_ID>
        <bmecat:SUPPLIER_PID>T-38</bmecat:SUPPLIER_PID>
        <bmecat:DESCRIPTION_SHORT>Notebookbag</bmecat:DESCRIPTION_SHORT>
      </PRODUCT_ID>
      <QUANTITY>4</QUANTITY>
      <bmecat:ORDER_UNIT>BG</bmecat:ORDER_UNIT>
    </PRODUCT_COMPONENT>
  </PRODUCT_COMPONENTS>
  <QUANTITY>4</QUANTITY>
  <bmecat:ORDER_UNIT>PK</bmecat:ORDER_UNIT>
  <PRODUCT_PRICE_FIX>
    <bmecat:PRICE_AMOUNT>1200</bmecat:PRICE_AMOUNT>
    <ALLOW_OR_CHARGES_FIX>
      <ALLOW_OR_CHARGE type="allowance">
        <ALLOW_OR_CHARGE_TYPE>rebate</ALLOW_OR_CHARGE_TYPE>
        <ALLOW_OR_CHARGE_VALUE>
          <AOC_PERCENTAGE_FACTOR>10.00</AOC_PERCENTAGE_FACTOR>
        </ALLOW_OR_CHARGE_VALUE>
      </ALLOW_OR_CHARGE>
      <ALLOW_OR_CHARGES_TOTAL_AMOUNT>120</ALLOW_OR_CHARGES_TOTAL_AMOUNT>
    </ALLOW_OR_CHARGES_FIX>
    <TAX_DETAILS_FIX>
      <bmecat:TAX_CATEGORY>standard_rate</bmecat:TAX_CATEGORY>
      <bmecat:TAX_TYPE>vat</bmecat:TAX_TYPE>
      <bmecat:TAX>0.19</bmecat:TAX>
      <TAX_AMOUNT>889.20</TAX_AMOUNT>
    </TAX_DETAILS_FIX>
  </PRODUCT_PRICE_FIX>
  <PRICE_LINE_AMOUNT>4680.00</PRICE_LINE_AMOUNT>
  <MIME_INFO>
    <MIME>
      <bmecat:MIME_TYPE>image/jpeg</bmecat:MIME_TYPE>
      <bmecat:MIME_SOURCE>front.jpg</bmecat:MIME_SOURCE>
      <bmecat:MIME_DESCR>Frontview</bmecat:MIME_DESCR>
    </MIME>
  </MIME_INFO>
</ORDER_ITEM>

```

```
<bmeecat:MIME_ALT>Picture Notebook Front</bmeecat:MIME_ALT>
<MIME_PURPOSE>thumbnail</MIME_PURPOSE>
</MIME>
<MIME>
  <MIME_EMBEDDED>
    <MIME_DATA contentType="image/jpeg">bnVyIGVpbiBUZXN0bGF1Zg==</MIME_DATA>
  </MIME_EMBEDDED>
  <bmeecat:MIME_DESCR>Notebook New Style</bmeecat:MIME_DESCR>
  <bmeecat:MIME_ALT>Bild Notebook New Style</bmeecat:MIME_ALT>
  <MIME_PURPOSE>freehand_sketch</MIME_PURPOSE>
</MIME>
</MIME_INFO>
</ORDER_ITEM>
```

PRODUCT_ID

(Product number)

Identifier of the product. The included elements ensure the capability of a unique identification of a product.





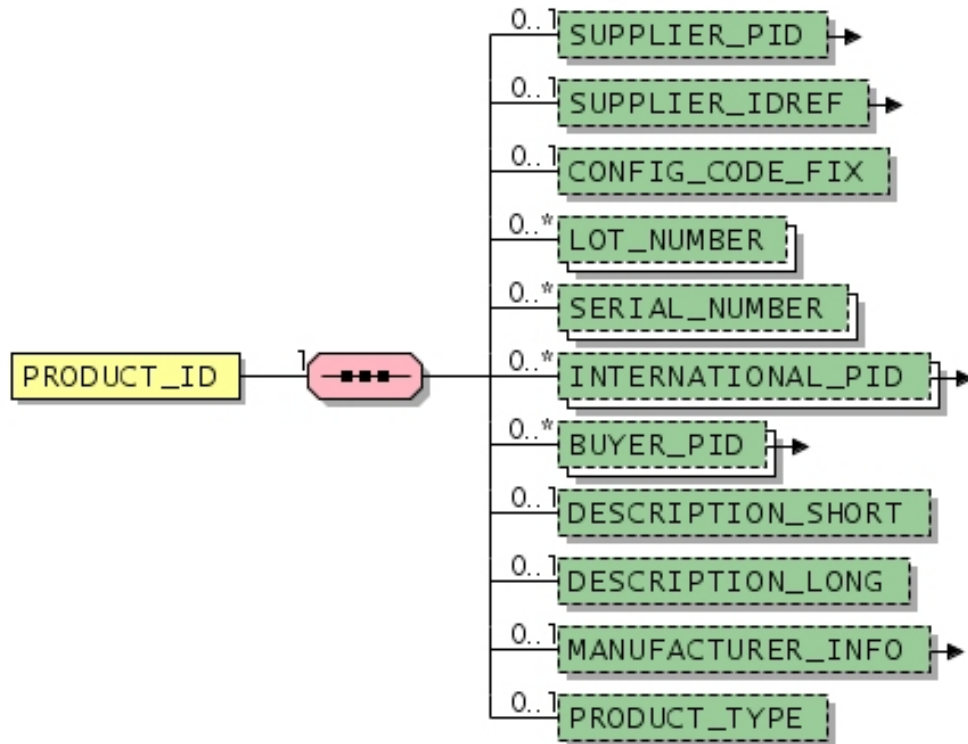



Example added.







General



Used in	Default value	Data type	Field length	Lang. specific	I.chg. in ver.
ORDER_ITEM, PRODUCT_COMPONENT	-	-	-	-	21fd

Elements										
Designation	Element name	Mandatory/Optional	Single/Multiple	Explanation	Default value	Data type	Field length	Lang. specific	I.chg. in ver.	
Supplier's product ID	SUPPLIER_PID - type	Optional	Single	<p>???This element contains the product number issued by the supplier. It is determining for ordering the product; it identifies the product in the supplier catalog. In multi-supplier catalogs, however, only the combination of SUPPLIER_PID and SUPPLIER_IDREF identifies a product.</p> <p> Some target systems are not able to accept all 32 characters (e.g., SAP max. 18 characters). It is therefore advisable to keep product identifications as short as possible.</p> <p>Are there different product variants (VARIANTS) the final product number is built via the concatenation of the (base) product number (SUPPLIER_PID) with the related product numbers supplements (SUPPLIER_AID_SUPPLEMENT).</p> <p> The (base) product number has to be distinct on its own even when variants or configurations are used.</p> <p><i>namespace: BMECAT</i></p> <p></p>	-	dtSTRING	32	-	2005	
Reference to supplier	SUPPLIER_IDREF - type	Optional	Single	<p>Reference to the supplier. It contains the unique identifier (PARTY_ID) of the respective party that is defined in the document (element PARTY). <i>namespace: BMECAT</i></p> <p></p>	-	dtSTRING	250	-	2005fd	
Configurationcode	CONFIG_CODE_FIX	Optional	Single	<p>The code describes the product in case of configurable or parameterizable products. The code can be determined via a configuration process or a remote call of a catalog (IPP).</p> <p> New element</p>	-	dtSTRING	6000	-	20v1	
lot number	LOT_NUMBER	Optional	Multiple	<p>Unique identifier of the lot where the product is originated.</p> <p> The usage of the term is common, however the lot number is a character sequence and therefore can contain alphanumeric characters.</p> <p> New element</p>	-	dtSTRING	80	-	20v1	

Elements

Designation	Element name	Mandatory/ Optional	Single/ Multiple	Explanation	Default value	Data type	Field length	Lang. specific	l.chg. in ver.
Serial number	SERIAL_NUMBER	Optional	Multiple	<p>Unique identifier for a single product (product instance).</p> <p> The term is commonly used, nevertheless a serial number can also consist of alphanumeric characters.</p> <p> New element</p>	-	dtSTRING	80	-	20v1
International product number	INTERNATIONAL_PID - type	Optional	Multiple	<p>Indicates an international product number (e.g., EAN). The underlying standard respectively organisation is given in the 'type' attribute. <i>namespace: BMECAT</i></p> <p></p>	-	dtSTRING	100	-	2005fd
Product ID of the buying company	BUYER_PID - type	Optional	Multiple	<p>Product number used by the buying firm. The "type" attribute specifies the type of ID. If the element is used multiple, the values of the attribute "type" must differ.</p> <p><i>namespace: BMECAT</i></p> <p></p>	-	dtSTRING	50	-	2005fd
Short description	DESCRIPTION_SHORT	Optional	Single	<p>This element contains the short description of the product. In general, the description should be short and, within the first 40 characters, unique and meaningful, because many software systems can only interpret these 40 characters (i.e. SAP-OCI, SAP R/3).</p> <p>Detailed descriptions are beneficial to product search, especially if many products are quite similar and differ only in specific details. In these cases, product search returns a list of products from which the right product can easily be determined.</p> <p>Abbreviations of essential product characteristics should be avoided (e.g., bw for black and white). However, abbreviations of organisations and standards can be used (e.g., ISO, VDE).</p> <p><i>namespace: BMECAT</i></p>	-	dtML- STRING	150	Yes	-

Elements

Designation	Element name	Mandatory/Optional	Single/Multiple	Explanation	Default value	Data type	Field length	Lang. specific	l.chg. in ver.
Long description	DESCRIPTION_LONG	Optional	Single	<p>This element contains the long description of the product.</p> <p>Format: The following HTML tags are supported: for bold, <i> for italic, <p> for paragraphs,
 for line break and / for lists. In order to transfer these, the characters '<' and '>' must be enclosed in quotation marks, or the BMEcat DTD will not be accepted by the XML parser (see also chapter Character encoding in XML).</p> <p>Example: '<' = &lt; or '>' = &gt;</p>  <p>The target system must support the interpretation of the day in order to achieve the desired formatting.</p> <p><i>namespace: BMECAT</i></p>	-	dtML-STRING	64000	Yes	1.2_fd
Manufacturer information	MANUFACTURER_INFO	Optional	Single	Information assigned to the article by the manufacturer is stored here.	-	-	-	-	2.0_fd
Product type	PRODUCT_TYPE	Optional	Single	<p>Characterizes the product with regard to its general type, i.e. being tangible or service <i>namespace: BMECAT</i></p>  <p>New element See also: Permitted values for element PRODUCT_TYPE</p>	-	dtSTRING	50	-	2005fd

Permitted values for element PRODUCT_TYPE

Designation	Element value	Explanation	l.chg. in ver.
Product bundle	bundle	The product is part of a product bundle.	2005fd
Component	component	The product is component of another product.	2005fd
Optionally configurable	configurable	The product can be configured. If the product is not configured by the user, it is determined by its default values. See also PRODUCT_TYPE =must_be_configured .	2005fd
Contract	contract	The product is a contract.	2005fd
Licence	license	The product is a licence.	2005fd
Orderable product	major	The product can be ordered.	2005fd
Product part	minor	The product can only be ordered in conjunction with another product.	2005fd
Configurable	must_be_configured	The product has to be configured, unless it can not be ordered. See also PRODUCT_TYPE =configurable .	2005fd
Physical product	physical	The product is physical, thus tangible.	2005fd

Permitted values for element PRODUCT_TYPE

Designation	Element value	Explanation	l.chg. in ver.
Professional Service	professional_services	The product is a professional service being provided by one or more individuals. The individuals are professionals in their field (e.g., accounting, educational, legal, medical, or architectural services).	2005fd
Service	service	The product is a service.	2005fd

Example

```
<PRODUCT_ID>
  <bmeecat:SUPPLIER_PID>NB-A4</bmeecat:SUPPLIER_PID>
  <bmeecat:DESCRIPTION_SHORT>Notebook, Black</bmeecat:DESCRIPTION_SHORT>
  <bmeecat:DESCRIPTION_LONG>Notebook incl. Einsteinium-CPU, 256 GB RAM and 1024 TB Harddrive</bmeecat:DESCRIPTION_LONG>
</PRODUCT_ID>
```

SUPPLIER_PID

(Supplier's product ID) namespace: BMECAT

???This element contains the product number issued by the supplier. It is determining for ordering the product; it identifies the product in the supplier catalog. In multi-supplier catalogs, however, only the combination of **SUPPLIER_PID** and **SUPPLIER_IDREF** identifies a product.



Some target systems are not able to accept all 32 characters (e.g., SAP max. 18 characters). It is therefore advisable to keep product identifications as short as possible.



This new element replaces the **SUPPLIER_AID** element. The type-attribute was added to this element.

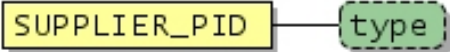

General

Used in	Default value	Data type	Field length	Lang. specific	l.chg. in ver.
PRODUCT_ID	-	dtSTRING	32	-	2005

Attributes

Designation	Attribute name	Mandatory/optional	Explanation	Default value	Data type	Field length	Lang. specific	l.chg. in ver.
Type of ID	type	Optional	This attribute specifies the type of ID, i.e. indicates the organization that has issued the ID. See also: Predefined values for attribute "type"	-	dtSTRING	50	-	-

Predefined values for attribute "type"

Designation	Attribute value	Explanation	l.chg. in ver.
Buyer-specific number	buyer_specific	Identification number defined by the buyer	2005
European Article Number	ean	European article number (14 characters), s. http://www.ean-int.org	2005
Global Trade Item Number	gtin	Global Trade Item Number, see http://www.uc-council.org/2005sunrise/global_trade_item_number.html	2005
Supplier-specific number	supplier_specific	Identification number defined by the supplier	2005

Predefined values for attribute "type"

Designation	Attribute value	Explanation	l.chg. in ver.
Universal Product Code	upc	Universal Product Code; see http://www.uc-council.org	2005
User defined type	User defined value, format: \w{1,50}	Identification of the user defined type . "\w{1,50}" means that the type identification has to be at least 1 character long up to a maximum of 50 characters.	2005

INTERNATIONAL_PID

(International product number) *namespace: BMECAT*

This element contains an international product number (e.g., EAN). The underlying standard respectively organisation is given in the 'type' attribute.



This new element replaces with an increased maximum field length (100 characters instead of 14 respectively 50 characters) the former **EAN** and **SUPPLIER_ALT_PID** elements.



General

Used in	Default value	Data type	Field length	Lang. specific	l.chg. in ver.
PRODUCT_ID	-	dtSTRING	100	-	2005fd

Attributes

Designation	Attribute name	Mandatory/optional	Explanation	Default value	Data type	Field length	Lang. specific	l.chg. in ver.
Type of international product number	type	Optional	Specification of the underlying standard respectively organisation See also: Predefined values for attribute "type"	-	dtSTRING	50	-	2005fd

Predefined values for attribute "type"

Designation	Attribute value	Explanation	l.chg. in ver.
European Article Number	ean	European article number (14 characters), s. http://www.gs1-germany.de/internet/content/e39/e50/e221/e241	2005fd
Global Trade Item Number	gtin	Global Trade Item Number, see http://www.gs1.org/productssolutions/barcodes/technical/idkeys/gtin.html	2005fd
Universal Product Code	upc	Universal Product Code; see http://www.gs1.org/productssolutions/barcodes/technical/bar_code_types.html	2005fd
User-defined type	User defined value, format: \w{1,50}	Identification of the user-defined type. "\w{1,50}" means that the type identification has to be at least 1 character long up to a maximum of 50 characters.	2005fd

BUYER_PID(Product ID of the buying company) *namespace: BMECAT*

This element contains the product number used by the buying company. The "type" attribute specifies the type of ID.

If the element is used multiple, the values of the attribute "type" must differ.

This new element replaces the **BUYER_AID** element.**General**

Used in	Default value	Data type	Field length	Lang. specific	l.chg. in ver.
PRODUCT_ID	-	dtSTRING	50	-	2005fd

Attributes

Designation	Attribute name	Mandatory/optional	Explanation	Default value	Data type	Field length	Lang. specific	l.chg. in ver.
Type of ID	type	Optional	This attribute specifies the type of ID, i.e. indicates the organization that has issued the ID. See also: Predefined values for attribute "type"	-	dtSTRING	50	-	-

Predefined values for attribute "type"

Designation	Attribute value	Explanation	l.chg. in ver.
Buyer-specific number	buyer_specific	Identification number defined by the buyer	2005fd
European Article Number	ean	European article number (14 characters), s. http://www.gs1-germany.de/internet/content/e39/e50/e221/e241	2005fd
Global Trade Item Number	gtin	Global Trade Item Number, see http://www.gs1.org/productssolutions/barcodes/technical/idkeys/gtin.html	2005fd
Universal Product Code	upc	Universal Product Code; see http://www.gs1.org/productssolutions/barcodes/technical/bar_code_types.html	2005fd
User defined type	User defined value, format: \w{1,50}	Identification of the user defined type. "\w{1,50}" means that the type identification has to be at least 1 character long up to a maximum of 50 characters.	2005fd

MANUFACTURER_INFO

(Manufacturer information)

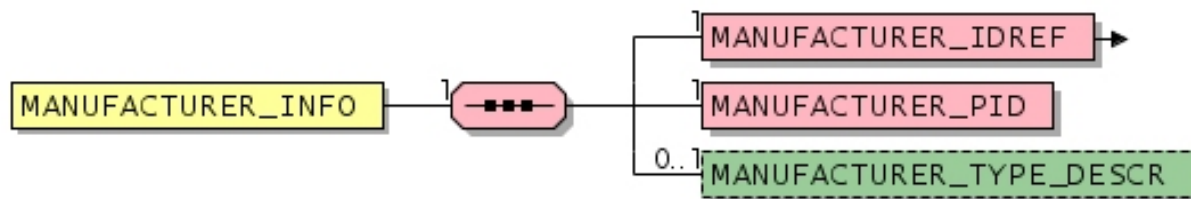

The element **MANUFACTURER_INFO** contains information assigned to the article by the manufacturer.



General

Used in	Default value	Data type	Field length	Lang. specific	l.chg. in ver.
PRODUCT_ID	-	-	-	-	2.0_fd

Elements

Designation	Element name	Mandatory/Optional	Single/Multiple	Explanation	Default value	Data type	Field length	Lang. specific	l.chg. in ver.
Reference to the manufacturer	MANUFACTURER_IDREF - type	Mandatory	Single	This element provides a reference to the manufacturer. It contains the unique identifier (PARTY_ID) of the respective party that is defined in the document (element PARTY). <i>namespace: BMECAT</i> 	-	dtSTRING	250	-	2005fd
Product ID of the manufacturer	MANUFACTURER_PID	Mandatory	Single	Product ID of the manufacturer <i>namespace: BMECAT</i>  This new element replaces former MANUFACTURER_AID element.	-	dtSTRING	50	-	2005fd
Manufacturer type description	MANUFACTURER_TYPE_DESCR	Optional	Single	The manufacturer's type description is a name for the product which may, in certain circumstances, be more widely-known than the correct product name. When a manufacturer's type description is specified, the name of the manufacturer must also be specified (MANUFACTURER_NAME). <i>namespace: BMECAT</i>	-	dtML-STRING	50	Yes	1.2_fd

MANUFACTURER_IDREF

(Reference to the manufacturer) *namespace: BMECAT*

This element provides a reference to the manufacturer. It contains the unique identifier (**PARTY_ID**) of the respective party that is defined in the document (element **PARTY**).



New element

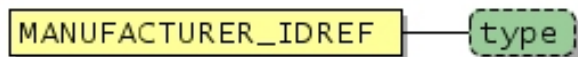

General

Used in	Default value	Data type	Field length	Lang. specific	l.chg. in ver.
MANUFACTURER_INFO	-	dtSTRING	250	-	2005fd

Attributes

Designation	Attribute name	Mandatory/optional	Explanation	Default value	Data type	Field length	Lang. specific	l.chg. in ver.
Coding standard	type	Optional	This attribute is used to state the coding standard to which the identifier (PARTY_ID) adheres. The most common coding standards are predefined. See also: Predefined values for attribute "type"	-	dtSTRING	250	-	1.2_fd

Predefined values for attribute "type"

Designation	Attribute value	Explanation	l.chg. in ver.
Buyer-specific number	buyer_specific	Identification number defined by the buyer	-
Customer specific number	customer_specific	Identification number defined by the customer	2005fd
Dun & Bradstreet	duns	DUNS-Number (see also http://dbuk.dnb.com/english/DataBase/duns.htm)	-
Global location number	iln	Internationally called GLN (see GLN below)	-
Global location number	gln	Global Location Number GLN (see also http://www.ean-int.org/locations.html)	2005fd
Party-specific number	party_specific	Identification number defined by the respective party	2005fd
Supplier-specific number	supplier_specific	Identification number defined by the supplier	-
Other codification standard	User defined value, format: \w{1,250}	Identificator of codification standard. "\w{1,250}" means that the identificator of the codification standard has to be at least 1 character long up to a maximum of 250 characters.	-

PRODUCT_FEATURES

(Product features)

This element can be used to (1) describe a product by features and/or to (2) map a product to a group of a classification system. The element should not be confused with **PRODUCT_COMPONENT**, which describes parts of a product (with their own **PRODUCT_ID**).

(1) The product description by features is done using the **FEATURE** element. The feature has to be named, and a value has to be assigned to this feature (**bmecat:FVALUE_DETAILS**). It can be complemented by the unit of measurement (**bmecat:FUNIT**). Moreover, it is possible to provide a detailed, complete definition of the feature (**CLASSIFICATION_SYSTEM_FEATURE_TEMPLATE**), i.e. data type and domain. If features are used that are pre-defined by a classification or feature system, then all features belonging to the same system have to be grouped in a common **PRODUCT_FEATURES** element. In this area, the respective system has to be referenced (**REFERENCE_FEATURE_SYSTEM_NAME**), eventually each feature has to be referenced by a **FREF** element.

All features that are not pre-defined by a classification or feature system have to be stored in the same **PRODUCT_FEATURES** element; this element may not contain **REFERENCE_FEATURE_SYSTEM_NAME**, **REFERENCE_FEATURE_GROUP_ID** or **REFERENCE_FEATURE_GROUP_NAME** elements; its **FEATURE** sub-elements may not include **FREF** elements.

For each **PRODUCT_FEATURES** area, the feature names must be unique, thus the values of all respective **bmecat:FNAME** elements are different. By defining multiple **PRODUCT_FEATURES** areas it is, however, possible to use the same feature name for various purposes.

(2) The **PRODUCT_FEATURES** element is also used for mapping products to classification groups. The respective classification system has to be referenced (**REFERENCE_FEATURE_SYSTEM_NAME**); eventually the classification group is either referenced by its identifier (**REFERENCE_FEATURE_GROUP_ID**) or directly named (**REFERENCE_FEATURE_GROUP_NAME**). It is not allowed to define two or more **PRODUCT_FEATURES** areas with references to the same classification system.



This new element replaces with a modified semantics the **ARTICLE_FEATURES** element; it has been extended by the following sub-elements: **REFERENCE_FEATURE_GROUP_ID2**, **GROUP_PRODUCT_ORDER**

The sub-element **CLASSIFICATION_GROUP_PRODUCTORDER** was renamed in **GROUP_PRODUCT_ORDER**.

Examples adapted.

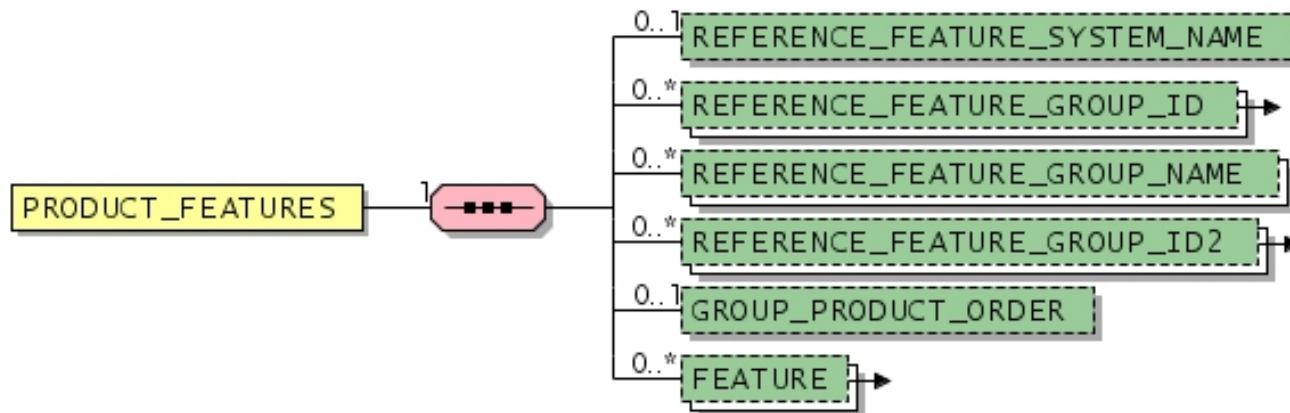





General

Used in	Default value	Data type	Field length	Lang. specific	I.chg. in ver.
ORDER_ITEM, PRODUCT_COMPONENT	-	-	-	-	21fd

Elements

Designation	Element name	Mandatory/Optional	Single/Multiple	Explanation	Default value	Data type	Field length	Lang. specific	I.chg. in ver.
Classification or feature system	REFERENCE_FEATURE_SYSTEM_NAME	Optional	Single	<p>Name of the referenced classification or feature system</p> <p>If the classification system is transferred by the T_NEW_CATALOG transaction and its CLASSIFICATION_SYSTEM element, the value of this element must be equal with the name defined in CLASSIFICATION_SYSTEM_NAME.</p> <p>Remark: The format for the name (CLASSIFICATION_SYSTEM_NAME) should comply with the following structure: "<Name>-<Major Version>.<Minor Version> <i>namespace: BMECAT</i></p> <p>See also: Predefined values for element REFERENCE_FEATURE_SYSTEM_NAME</p> <p>Examples ECLASS-4.1, UNSPSC-6.0801</p> <pre><REFERENCE_FEATURE_SYSTEM_NAME>ECLASS-4.1</REFERENCE_FEATURE_SYSTEM_NAME></pre>	-	dtSTRING	80	-	-
Group reference	REFERENCE_FEATURE_GROUP_ID-type	Optional	Multiple	<p>Reference to the unique identifier of an existing group of the respective classification system; this element may only be used if the REFERENCE_FEATURE_GROUP_NAME element is not used. <i>namespace: BMECAT</i></p>	-	dtSTRING	60	-	-
Group name reference	REFERENCE_FEATURE_GROUP_NAME	Optional	Multiple	<p>Reference to the unique, though language-dependent name of an existing group of the respective classification system</p> <p>This element may only be used if the REFERENCE_FEATURE_GROUP_ID element is not used.</p> <p>Notice: The group can also be referenced by its language-independent identifier (see REFERENCE_FEATURE_GROUP_ID).</p> <p><i>namespace: BMECAT</i></p>	-	dtML-STRING	60	Yes	-

Elements

Designation	Element name	Mandatory/Optional	Single/Multiple	Explanation	Default value	Data type	Field length	Lang. specific	l.chg. in ver.
Additional group reference	REFERENCE_FEATURE_GROUP_ID2 - type	Optional	Multiple	This element provides an additional identifier of the same group which has already been referenced in the REFERENCE_FEATURE_GROUP_ID element. The element should be only if the classification system defines two different identifier for the same group.  When classifying product according to eCI@ss, this element has to be filled with the eCI@ss field 'idcl' (primary key) and the 'type' attribute has to be set to 'flat'. <i>namespace: BMECAT</i> 	-	dtSTRING	60	-	2005fd
Classification group product order	GROUP_PRODUCT_ORDER	Optional	Single	Order number for the graphical user interface. When products of a group are listed they are always represented in ascending order (the first product is the one with the lowest number). <i>namespace: BMECAT</i>  New element This element was named CLASSIFICATION_GROUP_PRODUCTORDER in BMEcat 2005 final draft, now it is named GROUP_PRODUCT_ORDER .	-	dtINTEGER	-	-	2005
Product feature	FEATURE	Optional	Multiple	Information about a single product feature 	-	-	-	-	21fd

Predefined values for element REFERENCE_FEATURE_SYSTEM_NAME

Designation	Element value	Explanation	l.chg. in ver.
CPV	CPV-yyyy-mm-dd	Reference to the classification system CPV (Common Procurement Vocabulary) with version date (e.g., CPV-2003-12-16); see siehe http://simap.eu.int	2005fd
eCI@ss	ECLASS-x.y	Reference to the classification system eCI@ss with major version x and minor version y (e.g., ECLASS-5.1); see http://www.eclass-online.com	-
eOTD	EOTD-yyyy-mm-dd	Reference to the classification system eOTD (ECCMA Open Technical Dictionary) with version date (e.g., EOTD-2004-08-01); see http://www.eccma.org	2005fd
ETIM	ETIM-x.y	Reference to the classification system ETIM with major version x and minor version y (e.g., ETIM-2.0); see http://www.etim.de	-
GPC	GPC-x.y	Reference to the classification system EAN.UCC GPC (Global Product Classification) with major version x and minor version y (e.g., GPC-4.0); see http://www.gs1.org	2005fd
profiCI@ss	PROFICLASS-x.y	Reference to the classification system profiCI@ss with major version x and minor version y (e.g., PROFICLASS-2.1); see http://www.proficlass.de	2005fd
RNTD	RNTD-x.y	Reference to the classification system RNTD (RosettaNet Technical Dictionary) with major version x and minor version y (e.g., RNTD-4.0); see http://www.rosettanet.org	2005fd

Predefined values for element REFERENCE_FEATURE_SYSTEM_NAME

Designation	Element value	Explanation	l.chg. in ver.
RUS	RUS-x.y	Reference to the classification system RUS (Requisite Unifying Structure) with major version x and minor version y (e.g., RUS-4.0); see http://rusportal.requisite.com	2005fd
UNSPSC	UNSPSC-x.yyyy	Reference to the classification system UNSPSC with major version x and minor version y (e.g., UNSPSC-6.0801); see http://www.unspsc.org	-
Proprietary classification system	udf_NAME-x.y	Reference to a proprietary (non-standard) classification system. The value has to start with 'udf_' followed by the classification system name in capital letters, hyphen, and version (major version x and minor version y). For example: udf_MYSYSTEM-3.0. The length of the name is limited to 72 characters; the version to 7 characters.	-
Other classification system	User defined value, format: [w\-\.\.]{1,80}	Other standard classification system, which is not pre-defined in BMEcat, can be described in a similar way: The name of the system in capital, followed by a hyphen and the version information. For instance, NAME-3.4. The length of the name is limited to 72 characters. The version information, where major and minor version are separated by a dot, is limited to 7 characters.	2005fd

Example

In this example, a stacking tray is described according to two different classification systems. However, the description according to eCI@ss serves only as an example, i.e. not all features are specified.

```

<PRODUCT_FEATURES>
  <bmeecat:REFERENCE_FEATURE_SYSTEM_NAME>udf_MeBuKla-0.97</bmeecat:REFERENCE_FEATURE_SYSTEM_NAME>
  <bmeecat:REFERENCE_FEATURE_GROUP_NAME>Stacking tray</bmeecat:REFERENCE_FEATURE_GROUP_NAME>
  <FEATURE>
    <bmeecat:FNAME>Size</bmeecat:FNAME>
    <bmeecat:FVALUE>DIN A4</bmeecat:FVALUE>
  </FEATURE>
  <FEATURE>
    <bmeecat:FNAME>Width</bmeecat:FNAME>
    <bmeecat:FVALUE>240</bmeecat:FVALUE>
    <bmeecat:FUNIT>mm</bmeecat:FUNIT>
  </FEATURE>
  <FEATURE>
    <bmeecat:FNAME>Material</bmeecat:FNAME>
    <bmeecat:FVALUE>Kunststoff</bmeecat:FVALUE>
  </FEATURE>
  <FEATURE>
    <bmeecat:FNAME>Color</bmeecat:FNAME>
    <bmeecat:FVALUE>rot</bmeecat:FVALUE>
  </FEATURE>
</PRODUCT_FEATURES>
<PRODUCT_FEATURES>
  <bmeecat:REFERENCE_FEATURE_SYSTEM_NAME>ECLASS-5.1</bmeecat:REFERENCE_FEATURE_SYSTEM_NAME>
  <bmeecat:REFERENCE_FEATURE_GROUP_ID>24-29-11-01</bmeecat:REFERENCE_FEATURE_GROUP_ID>
  <bmeecat:REFERENCE_FEATURE_GROUP_ID2 type="flat">AKF56000201</bmeecat:REFERENCE_FEATURE_GROUP_ID2>
  <FEATURE>
    <bmeecat:FT_IDREF>BAF016001</bmeecat:FT_IDREF>
    <bmeecat:FVALUE>240</bmeecat:FVALUE>
  </FEATURE>
  <FEATURE>
    <bmeecat:FT_IDREF>BAA351001</bmeecat:FT_IDREF>
    <bmeecat:FVALUE>red</bmeecat:FVALUE>
  </FEATURE>
  <FEATURE>
    <bmeecat:FT_IDREF>BAF302001</bmeecat:FT_IDREF>
    <bmeecat:FVALUE>DIN A4</bmeecat:FVALUE>
  </FEATURE>
</PRODUCT_FEATURES>

```

REFERENCE_FEATURE_GROUP_ID

(Group reference) *namespace: BMECAT*

This element contains a reference to the unique identifier of an existing group of the respective classification system

The group can also be referenced by its unique, though language-dependent name (see [REFERENCE_FEATURE_GROUP_NAME](#)). In this case, the **REFERENCE_FEATURE_GROUP_ID** element may not be used.

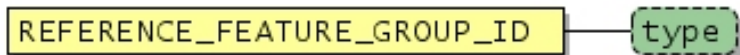

General

Used in	Default value	Data type	Field length	Lang. specific	l.chg. in ver.
PRODUCT_FEATURES	-	dtSTRING	60	-	-

Attributes

Designation	Attribute name	Mandatory/optional	Explanation	Default value	Data type	Field length	Lang. specific	l.chg. in ver.
Codification	type	Optional	Determines whether the group ID describes the position of the respective group in the hierarchy.  New attribute See also: Permitted values for attribute "type"	-	dtSTRING	20	-	2005fd

Permitted values for attribute "type"

Designation	Attribute value	Explanation	l.chg. in ver.
flat	flat	The group ID does not describe the position of the respective group in the hierarchy.	2005fd
Hierarchy	hierarchy	The group ID describes the position of the respective group in the hierarchy.	2005fd

REFERENCE_FEATURE_GROUP_ID2

(Additional group reference) *namespace: BMECAT*

This element provides an additional identifier of the same group which has already been referenced in the **REFERENCE_FEATURE_GROUP_ID** element. The element should be only if the classification system defines two different identifier for the same group.



When classifying product according to eCI@ss, this element has to be filled with the eCI@ss field 'idcl' (primary key) and the 'type' attribute has to be set to 'flat'.



New element

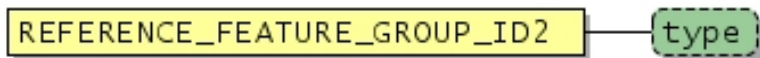

General

Used in	Default value	Data type	Field length	Lang. specific	l.chg. in ver.
PRODUCT_FEATURES	-	dtSTRING	60	-	2005fd

Attributes

Designation	Attribute name	Mandatory/optional	Explanation	Default value	Data type	Field length	Lang. specific	l.chg. in ver.
Codification	type	Optional	Determines whether the group ID describes the position of the respective group in the hierarchy. See also: Permitted values for attribute "type"	-	dtSTRING	20	-	2005fd

Permitted values for attribute "type"

Designation	Attribute value	Explanation	l.chg. in ver.
flat	flat	The group ID does not describe the position of the respective group in the hierarchy.	2005fd
Hierarchy	hierarchy	The group ID describes the position of the respective group in the hierarchy.	2005fd

FEATURE

(Product feature)

This element contains information on a product features (i.e., feature name, data type, explanations, domain).

Using the VARIANTS feature it is also possible to describe variants of the product.



The element was revised and the following sub-elements were added: **FREF** (in 2005fd CLASSIFICATION_FEATURE_REF), **CLASSIFICATION_SYSTEM_FEATURE_TEMPLATE**, **VALUE_IDREF**, **FVALUE_TYPE**. The sub-element **CLASSIFICATION_FEATURE_REF** was renamed to **FREF**. The sub-element **CLASSIFICATION_SYSTEM_FEATURE_TEMPLATE** was replaced with the fully identical element **FTEMPLATE**. The sub-element **FREF** was replaced with the fully identical element **FT_IDREF**. Example adapted.

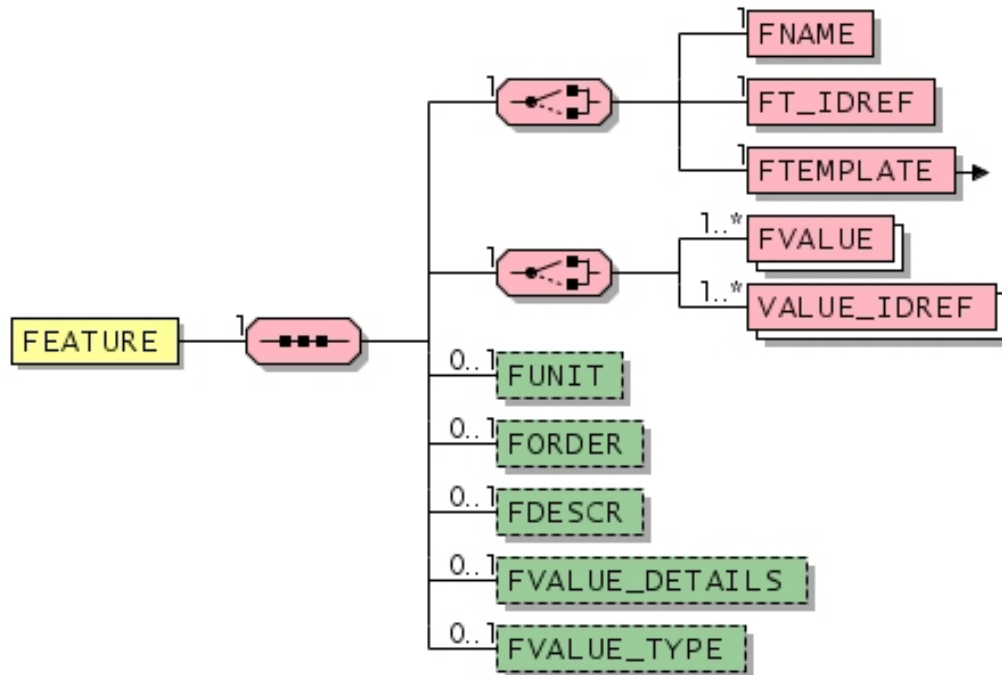

General

Used in	Default value	Data type	Field length	Lang. specific	I.chg. in ver.
PRODUCT_FEATURES	-	-	-	-	21fd

Elements										
Designation	Element name	Mandatory/Optional	Single/Multiple	Explanation	Default value	Data type	Field length	Lang. specific	I.chg. in ver.	
Feature name	FNAME	Mandatory	Single	<p>Unique name used to describe the feature within the PRODUCT_FEATURES element.</p> <p>If in this feature is part of a referenced classification or feature group system, then the feature name must correspond to the name that is defined in the respective system.</p> <p>This element is language-dependent, thus the feature name has to be given in the language that is set in the document header (HEADER).</p> <p><i>namespace: BMECAT</i></p>	-	dtML-STRING	60	Yes	-	
Feature reference	FT_IDREF	Mandatory	Single	<p>Reference to the unique ID of a feature (seeCLASSIFICATION_SYSTEM_FEATURE_TEMPLATE) <i>namespace: BMECAT</i></p>	-	dtSTRING	60	-	-	
Feature definition	FTEMPLATE	Mandatory	Single	<p>Definition of the feature <i>namespace: BMECAT</i></p> 	-	-	-	-	2005	
Feature value	FVALUE	Mandatory	Multiple	<p>Actual value(s) of the respective feature</p> <p>This element may only be specified if the element VARIANTS is not specified.</p> <p>FVALUE can occur as a multiple value, e.g. for describing a value range (Range) or a set of values (Set).</p> <p>If the element references a standard classification system which also pre-defines possible feature values for (alpha-numerical) features, the feature values must be derived from these pre-defined values.</p> <p><i>namespace: BMECAT</i></p> <p>Example 1</p> <pre><FNAME>Color</FNAME> <FVALUE>red</FVALUE></pre> <p>Example 2</p> <pre><FNAME>Voltage (adjustable from/to)</FNAME> <FVALUE>6</FVALUE> <FVALUE>12</FVALUE> <FUNIT>V</FUNIT></pre> <p>Example 3</p> <pre><FNAME>Test mark</FNAME> <FVALUE>VDE</FVALUE> <FVALUE>CE</FVALUE></pre>	-	dtML-STRING	60	Yes	1.2_fd	

Elements

Designation	Element name	Mandatory/Optional	Single/Multiple	Explanation	Default value	Data type	Field length	Lang. specific	l.chg. in ver.
Reference to a value	VALUE_IDREF	Mandatory	Multiple	<p>Reference to the unique identifier of a value. The reference must point to a value defined in the document (element ALLOWED_VALUE identified by ALLOWED_VALUE_ID).</p> <p>This element can only be used for defining features of a classification system; it can not be used for defining features directly for products (PRODUCT_FEATURES) or for configurations (CONFIG_FEATURE).</p> <p><i>namespace: BMECAT</i></p> <p> New element</p>	-	dtSTRING	60	-	2005fd
Feature unit	FUNIT	Optional	Single	<p>Unit of measurement of the feature</p> <p>Standard measuring units should be used if possible (refer also to Type dtUNIT).</p> <p>If the element references a standard classification system which also pre-defines feature units for (numerical) features, the entry for the measuring unit in this element must correspond to the one pre-defined or the element can be left empty.</p> <p><i>namespace: BMECAT</i></p>	-	dtSTRING	20	-	-
Feature order	FORDER	Optional	Single	<p>Order in which the feature must appear in the referenced group in the target system; the order is fixed using ascending integer values</p> <p>If the element references a standard classification system which also pre-defines feature orders for features, the entry for the order in this element must correspond to the one pre-defined or the element can be left empty. <i>namespace: BMECAT</i></p>	-	dtINTEGER	-	-	-
Feature description	FDESCR	Optional	Single	<p>Element which can be used to describe the exact meaning of the feature; the purpose of this element is not to explain the value of the feature in more detail. <i>namespace: BMECAT</i></p> <p>Example</p> <pre><FNAME>Color</FNAME> <FVALUE>Red</FVALUE> <FDESCR>The feature color specifies the color of the table top and not the color of the table legs.</FDESCR></pre>	-	dtML-STRING	250	Yes	1.2_fd

Elements

Designation	Element name	Mandatory/Optional	Single/Multiple	Explanation	Default value	Data type	Field length	Lang. specific	l.chg. in ver.
Additional details about the feature value	FVALUE_DETAILS	Optional	Single	<p>Element which can be used to give more details about the feature value; thus the purpose of this element is to explain the value of the feature in more detail (not the explanation of the feature itself).</p> <p>This element is mainly useful, for example, for transferring manufacturer-specific value descriptions whenever only standard values are permitted as feature values in the given classification system.</p> <p><i>namespace: BMECAT</i></p> <p>Example</p> <pre><FNAME>Color</FNAME> <FVALUE>White</FVALUE> <FVALUE_DETAILS>Polar</FVALUE_DETAILS></pre>	-	dtML-STRING	250	Yes	1.2_fd
Feature value type	FVALUE_TYPE	Optional	Single	<p>Indicates how the feature domain is structured. <i>namespace: BMECAT</i></p> <p></p> <p>New element See also: Permitted values for element FVALUE_TYPE</p>	-	dtSTRING	20	-	2005fd

Permitted values for element FVALUE_TYPE

Designation	Element value	Explanation	l.chg. in ver.
Choice of values	choice	Indicates that the feature domain is a set of values from which one values must be chosen.	2005fd
Range of values	range	Indicates that the feature domain is a range between two values.	2005fd
Set of values	set	Indicates that the feature domain is a set of values.	2005fd

Example 1

Classification of a product according to ETIM-1.0

```

<PRODUCT_FEATURES>
  <bmeecat:REFERENCE_FEATURE_SYSTEM_NAME>ETIM-1.0</bmeecat:REFERENCE_FEATURE_SYSTEM_NAME>
  <bmeecat:REFERENCE_FEATURE_GROUP_NAME>NV Halogen light</bmeecat:REFERENCE_FEATURE_GROUP_NAME>
  <FEATURE>
    <bmeecat:FNAME>Diameter</bmeecat:FNAME>
    <bmeecat:FVALUE>9</bmeecat:FVALUE>
    <bmeecat:FUNIT>mm</bmeecat:FUNIT>
  </FEATURE>
  <FEATURE>
    <bmeecat:FNAME>ZVEI-short description</bmeecat:FNAME>
    <bmeecat:FVALUE>QT-tr 9</bmeecat:FVALUE>
  </FEATURE>
  <FEATURE>
    <bmeecat:FNAME>Length</bmeecat:FNAME>
    <bmeecat:FVALUE>33</bmeecat:FVALUE>
    <bmeecat:FUNIT>mm</bmeecat:FUNIT>
  </FEATURE>
  <FEATURE>
    <bmeecat:FNAME>Life cycle</bmeecat:FNAME>
    <bmeecat:FVALUE>2000</bmeecat:FVALUE>
    <bmeecat:FUNIT>h</bmeecat:FUNIT>
  </FEATURE>
  <FEATURE>
    <bmeecat:FNAME>Color temperature</bmeecat:FNAME>
    <bmeecat:FVALUE>0</bmeecat:FVALUE>
    <bmeecat:FUNIT>K</bmeecat:FUNIT>
  </FEATURE>
  <FEATURE>
    <bmeecat:FNAME>Holder/pedestal</bmeecat:FNAME>
    <bmeecat:FVALUE>G4</bmeecat:FVALUE>
  </FEATURE>
  <FEATURE>
    <bmeecat:FNAME>Version</bmeecat:FNAME>
    <bmeecat:FVALUE>Clear</bmeecat:FVALUE>
    <bmeecat:FVALUE_DETAILS>Special clear</bmeecat:FVALUE_DETAILS>
  </FEATURE>
  <FEATURE>
    <bmeecat:FNAME>Filament shape</bmeecat:FNAME>
    <bmeecat:FVALUE>Axial (vertical)</bmeecat:FVALUE>
  </FEATURE>
  <FEATURE>
    <bmeecat:FNAME>Max capacity</bmeecat:FNAME>
    <bmeecat:FVALUE>20</bmeecat:FVALUE>
    <bmeecat:FUNIT>W</bmeecat:FUNIT>
  </FEATURE>
  <FEATURE>
    <bmeecat:FNAME>Supply voltage</bmeecat:FNAME>
    <bmeecat:FVALUE>12</bmeecat:FVALUE>
    <bmeecat:FUNIT>V</bmeecat:FUNIT>
  </FEATURE>
</PRODUCT_FEATURES>

```

Example 2

User-defined classification

The color and weight of the “Charlie casual shirt” must be described with the aid of FEATURE elements using a customer-specific feature system.

```
<PRODUCT_FEATURES>
  <bmeecat:REFERENCE_FEATURE_SYSTEM_NAME>udf_HeMoMeGu-1.0</bmeecat:REFERENCE_FEATURE_SYSTEM_NAME>
  <bmeecat:REFERENCE_FEATURE_GROUP_ID>123</bmeecat:REFERENCE_FEATURE_GROUP_ID>
  <FEATURE>
    <bmeecat:FNAME>Color</bmeecat:FNAME>
    <bmeecat:FVALUE>Red</bmeecat:FVALUE>
    <bmeecat:FDESCR>The color describes the basic tone of the shirt, there could however be appliquéés of different colors on the shirt </bmeecat:FDESCR>
    <bmeecat:FVALUE_DETAILS>Pink</bmeecat:FVALUE_DETAILS>
  </FEATURE>
  <FEATURE>
    <bmeecat:FNAME>Weight</bmeecat:FNAME>
    <bmeecat:FVALUE>500</bmeecat:FVALUE>
    <bmeecat:FUNIT>g</bmeecat:FUNIT>
  </FEATURE>
</PRODUCT_FEATURES>
```

FTEMPLATE

(Feature definition) *namespace: BMECAT*

This element defines a feature, it does not define the feature value though.



New element

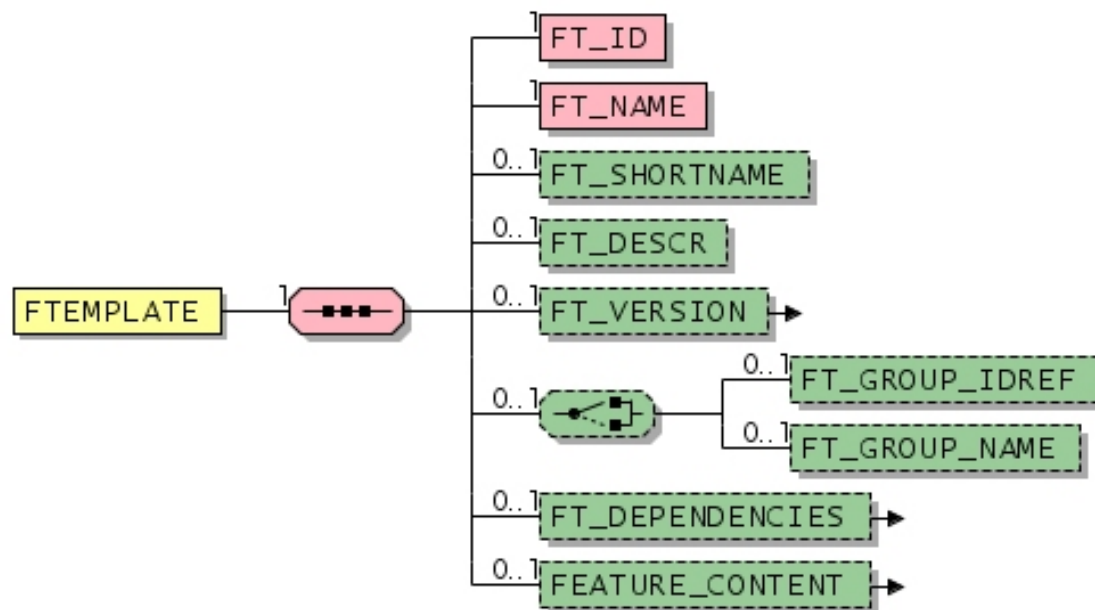







General

Used in	Default value	Data type	Field length	Lang. specific	I.chg. in ver.
FEATURE	-	-	-	-	2005

Elements

Designation	Element name	Mandatory/Optional	Single/Multiple	Explanation	Default value	Data type	Field length	Lang. specific	I.chg. in ver.
Feature identifier	FT_ID	Mandatory	Single	Unique identifier of the feature. This identifier ist required for referencing the feature from a classification group. <i>namespace: BMECAT</i>	-	dtSTRING	60	-	-

Elements

Designation	Element name	Mandatory/Optional	Single/Multiple	Explanation	Default value	Data type	Field length	Lang. specific	l.chg. in ver.
Feature name	FT_NAME	Mandatory	Single	This element defines the feature name. <i>namespace: BMECAT</i>  The maximum length has been extended from 60 characters to 80 characters.	-	dtML-STRING	80	Yes	2005fd
Feature short name	FT_SHORTNAME	Optional	Single	Short name of the feature in addition to its name <i>namespace: BMECAT</i>  New element	-	dtML-STRING	80	Yes	2005fd
Feature description	FT_DESCR	Optional	Single	Description of the feature and its semantics; it does not describe the value of the feature. This element is especially useful for describing user-defined, non-standardized features. <i>namespace: BMECAT</i>  The maximum length has been extended from 250 characters to 16,000 characters. Example <pre><FT_NAME>Colour</FT_NAME> <FT_DESCR>The feature color represents the color of the tabletop, but not the colour of the table legs.</FT_DESCR></pre>	-	dtML-STRING	16000	Yes	2005fd
Version of the feature	FT_VERSION	Optional	Single	Detailed information on the version of the feature <i>namespace: BMECAT</i> 	-	-	-	-	2005fd
Feature group ID reference	FT_GROUP_IDREF	Optional	Single	Reference to the unique ID of a feature group. The reference must point to a FT_GROUP_ID , which has been defined in the FT_GROUP element for the respective classification system. <i>namespace: BMECAT</i>  New element	-	dtSTRING	60	-	2005
Feature group name	FT_GROUP_NAME	Optional	Single	Specifies the name of the feature group; e.g., "Technical features" <i>namespace: BMECAT</i>  New element	-	dtML-STRING	80	Yes	2005
Feature dependencies	FT_DEPENDENCIES	Optional	Single	List of features on which the current feature depends <i>namespace: BMECAT</i> 	-	-	-	-	2005

Elements

Designation	Element name	Mandatory/ Optional	Single/ Multiple	Explanation	Default value	Data type	Field length	Lang. specific	I.chg. in ver.
Feature content definiti- on	FEATURE_CONTENT	Optional	Single	Detailed information on the feature content, e.g., data type, unit of measurement, domain of values, synonyms, and many more characteristics <i>namespace: BMECAT</i> 	-	-	-	-	2005

FT_VERSION

(Version of the feature) *namespace: BMECAT*

This element contains detailed information on the version of the feature and its version history.



New element

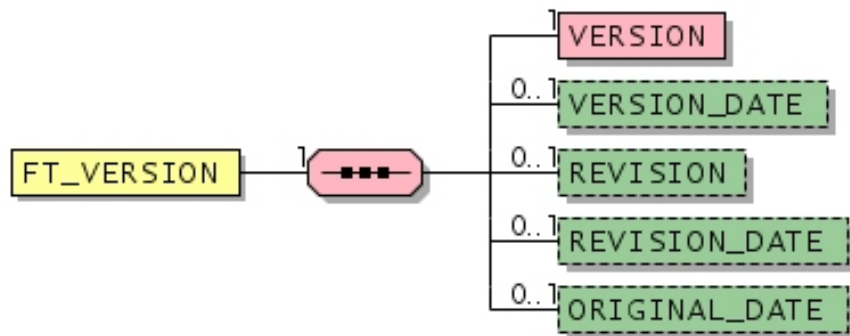



General

Used in	Default value	Data type	Field length	Lang. specific	l.chg. in ver.
FTEMPLATE	-	-	-	-	2005fd

Elements

Designation	Element name	Mandatory/Optional	Single/Multiple	Explanation	Default value	Data type	Field length	Lang. specific	l.chg. in ver.
Version	VERSION	Mandatory	Single	Detailed information on the version <i>namespace: BMECAT</i> New element	-	dtSTRING	20	-	2005fd
Version date	VERSION_DATE	Optional	Single	Date of the given version <i>namespace: BMECAT</i> New element	-	dtDATETIME	-	-	2005fd
Revision	REVISION	Optional	Single	Revision number of the given version <i>namespace: BMECAT</i> New element	-	dtSTRING	20	-	2005fd

Elements

Designation	Element name	Mandatory/ Optional	Single/ Multiple	Explanation	Default value	Data type	Field length	Lang. specific	l.chg. in ver.
Revision date	REVISION_DATE	Optional	Single	Date of the latest revision <i>namespace: BMECAT</i>  New element	-	dtDATE-TIME	-	-	2005fd
Original date	ORIGINAL_DATE	Optional	Single	Date of the first version in its first revision <i>namespace: BMECAT</i>  New element	-	dtDATE-TIME	-	-	2005fd

FT_DEPENDENCIES

(Feature dependencies) *namespace: BMECAT*

This element contains a list of features on which the current feature depends; hence it is possible to express, for instance, that the feature 'length' depends on the feature 'temperature'. The features that determine the current feature are referenced by their identifier.



New element

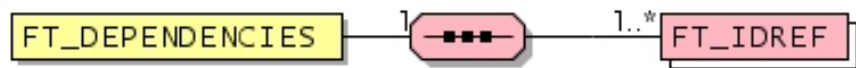

General

Used in	Default value	Data type	Field length	Lang. specific	l.chg. in ver.
FTEMPLATE	-	-	-	-	2005

Elements

Designation	Element name	Mandatory/Optional	Single/Multiple	Explanation	Default value	Data type	Field length	Lang. specific	l.chg. in ver.
Feature reference	FT_IDREF	Mandatory	Multiple	Reference to the unique ID of a feature (see CLASSIFICATION_SYSTEM_FEATURE_TEMPLATE) <i>namespace: BMECAT</i>	-	dtSTRING	60	-	-

FEATURE_CONTENT

(Feature content definition) *namespace: BMECAT*

This element contains detailed information on the feature content, e.g., data type, unit of measurement, application, synonyms, and many more characteristics.



New element



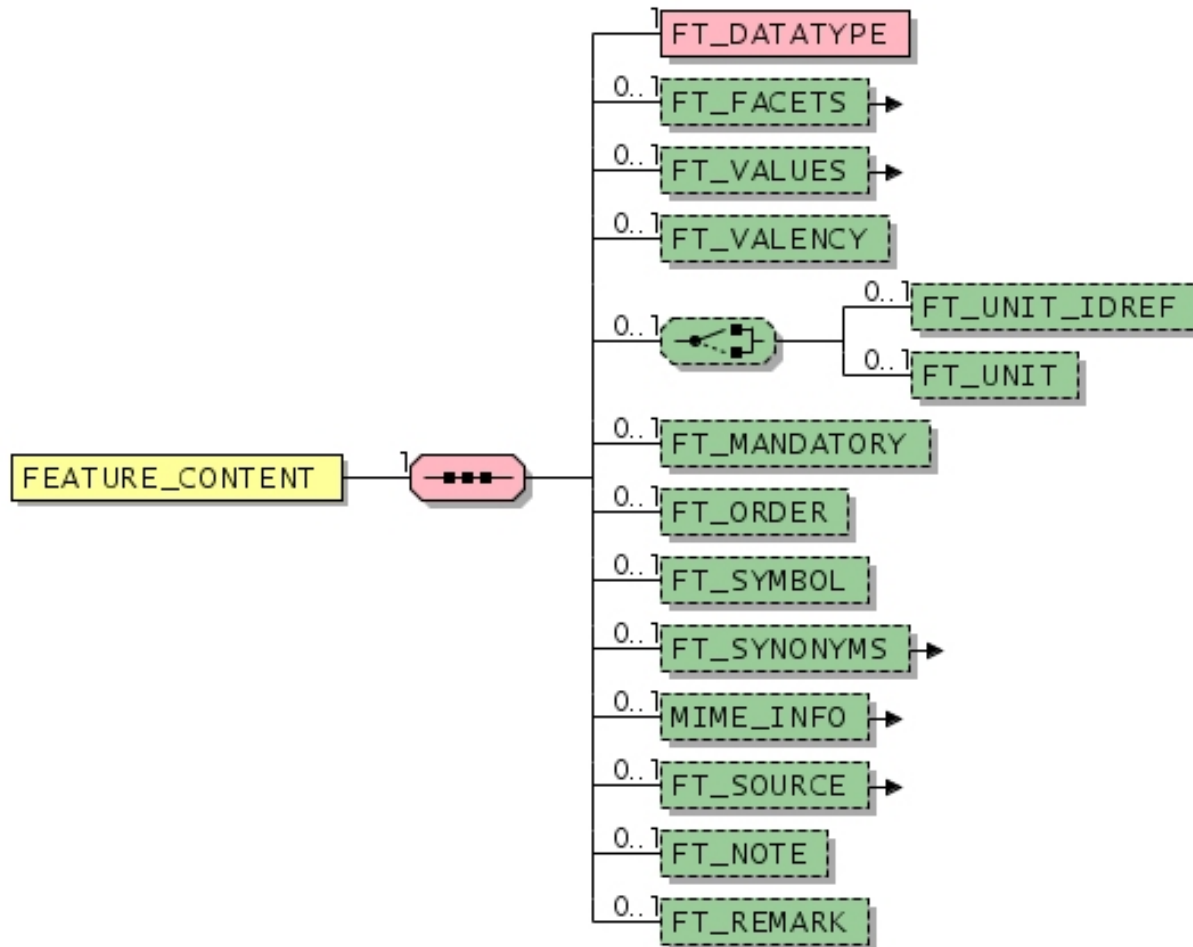

The sub-element **FT_DOMAIN_VALUES** was renamed to **FT_VALUES**.







General

Used in	Default value	Data type	Field length	Lang. specific	I.chg. in ver.
FTEMPLATE	-	-	-	-	2005

Elements

Designation	Element name	Mandatory/Optional	Single/Multiple	Explanation	Default value	Data type	Field length	Lang. specific	I.chg. in ver.
Feature data type	FT_DATATYPE	Mandatory	Single	This element contains the data type of the feature. <i>namespace: BMECAT</i> See also: Permitted values for element FT_DATATYPE	-	dtSTRING	20	-	-
Data type restrictions	FT_FACETS	Optional	Single	List of data type restrictions <i>namespace: BMECAT</i> 	-	-	-	-	2005fd
Feature domain values	FT_VALUES	Optional	Single	List of allowed values for the feature (only available for enumerative features) <i>namespace: BMECAT</i> 	-	-	-	-	2005
Feature valency	FT_VALENCY	Optional	Single	Indicates whether the product feature can have more than one value (multivalent) or only one value (univalent). <i>namespace: BMECAT</i>  New element See also: Permitted values for element FT_VALENCY	univalent	dtSTRING	20	-	2005fd
Feature unit ID reference	FT_UNIT_IDREF	Optional	Single	Reference to the unique ID of a unit of measurement. The reference must point to a UNIT_ID , which has been defined in the UNIT element for the respective classification system. This element can only be used for defining features of a classification system. Therefore, it can not be used on the product level for defining static features (PRODUCT_FEATURES) or for configuration purposes (CONFIG_FEATURE). <i>namespace: BMECAT</i>  This new element replaces with a modified semantics the former FT_UNIT element.	-	dtSTRING	60	-	2005fd
Feature unit	FT_UNIT	Optional	Single	Unit of measurement for the feature; the unit should be coded in accordance with the dtUNIT data type. <i>namespace: BMECAT</i>  The maximum length has been extended from 20 characters to 80 characters.	-	dtSTRING	80	-	2005fd
Mandatory feature	FT_MANDATORY	Optional	Single	This element specifies, whether the feature is mandatory or optional; if so, the feature must be used when classifying a respective product. <i>namespace: BMECAT</i>	-	dtBOOLEAN	-	-	-







Elements

Designation	Element name	Mandatory/ Optional	Single/ Multiple	Explanation	Default value	Data type	Field length	Lang. specific	l.chg. in ver.
Feature order	FT_ORDER	Optional	Single	Defines the order (sequence) in which the feature has to be presented in the target system. <i>namespace: BMECAT</i>	-	dtINTEGER	-	-	-
Feature symbol	FT_SYMBOL	Optional	Single	Symbol of the feature <i>namespace: BMECAT</i>	-	dtML-STRING	20	Yes	1.2
Feature synonyms	FT_SYNONYMS	Optional	Single	List of synonyms for the feature name <i>namespace: BMECAT</i> 	-	-	-	-	2005fd
Additional multimedia information	MIME_INFO	Optional	Single	Information about multimedia files For example an illustration which clarifies the measurements relevant for the feature or any other feature related document could be added here. <i>namespace: BMECAT</i>	-	-	-	-	-
Feature source	FT_SOURCE	Optional	Single	Source for the feature definition which has been given in the FT_DESCR element; e.g. a reference to a document, standard or definition describing the feature. <i>namespace: BMECAT</i> 	-	-	-	-	2005
Feature note	FT_NOTE	Optional	Single	The note should be extracted from the source of the definition (element FT_SOURCE). It increases the tangibility of the definition. This element has been adopted from ISO 13584. <i>namespace: BMECAT</i>  New element	-	dtML-STRING	16000	Yes	2005fd
Feature remark	FT_REMARK	Optional	Single	Remark giving additional information about the feature and its definition. This element has been adopted from ISO 13584. <i>namespace: BMECAT</i>  New element	-	dtML-STRING	16000	Yes	2005fd

Permitted values for element FT_DATATYPE

Designation	Element value	Explanation	l.chg. in ver.
Alphanumeric	alphanumeric	Alphanumeric string, see also data type dtSTRING	-
Boolean value	boolean	"true" or "false", see data type dtBOOLEAN	-

Permitted values for element FT_DATATYPE

Designation	Element value	Explanation	l.chg. in ver.
Class instance type	class_instance_type	Reference to a classification group. By this type it is possible to define a feature that establishes a relationship to another product class; e.g., feature "component". This type has been adopted from the ISO 13584 standard.  New value	2005
Positive number	count	Positive number, see also data type dtCOUNT  New value	2005fd
Currency	currency	Currency code, see also data type dtCURRENCIES  New value	2005
Date	date	Date, see also data type dtDATETIME  New value	2005fd
Date and time	date-time	Date and time, see also data type dtDATETIME  New value	2005fd
Floating-point number	float	Floating-point number, see also data type dtFLOAT  New value	2005fd
Integer value	integer	Integer value, see also data type dtINTEGER	-
Boolean value	logic	"true" or "false", see data type dtBOOLEAN	-
Named type	named_type	Named type. This type has been adopted from the ISO 13584 standard.  New value	2005
Number	number	Number, see also data type dtNUMBER	-
Numeric	numeric	Numeric, see also data type dtNUMBER	-
Integer range	range-integer	Range definition by two integer values (see also FEATURE , Beispiel 1)	-
Numeric range	range-numeric	Range definition by two numeric values (see also FEATURE , Beispiel 1)	-

Permitted values for element FT_DATATYPE

Designation	Element value	Explanation	l.chg. in ver.
Alphanumeric set	set-alphanumeric	Set of alphanumeric values (see also FEATURE , Beispiel 1)	-
Integer set	set-integer	Set of integer values (see also FEATURE , Beispiel 1)	-
Numeric set	set-numeric	Set of numeric values (see also FEATURE , Beispiel 1)	-
Alphanumeric	string	Alphanumeric string, see also data type dtSTRING	-
Time	time	Time, see also data type dtTIME  New value	2005fd

Permitted values for element FT_VALENCY

Designation	Element value	Explanation	l.chg. in ver.
Multivalent	multivalent	The feature can have more than one value.	2005fd
Univalent	univalent	The feature can only have one value.	2005fd

FT_FACETS

(Data type restrictions) *namespace: BMECAT*

This element contains a list of data type restrictions. The restrictions (**FT_FACET**) are based on: XML Schema Part 2: Data types Second Edition - W3C Recommendation 28 October 2004 (<http://www.w3.org/TR/xmlschema-2/#dt-constraining-facet>)



New element

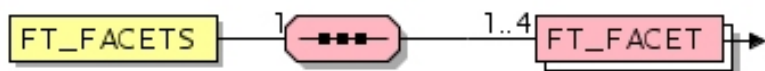

General

Used in	Default value	Data type	Field length	Lang. specific	l.chg. in ver.
FEATURE_CONTENT	-	-	-	-	2005fd

Elements

Designation	Element name	Mandatory/Optional	Single/Multiple	Explanation	Default value	Data type	Field length	Lang. specific	l.chg. in ver.
Data type restriction	FT_FACET - type	Mandatory	Multiple (4)	Restriction of the datatype, e.g. maximum field length <i>namespace: BMECAT</i> 	-	dtSTRING	20	-	2005fd

Example 1: String

The value of the feature is a string, which has length between 1 and 20 characters.

```

<FEATURE_CONTENT>
  <FT_DATATYPE>string</FT_DATATYPE>
  <FT_FACETS>
    <FT_FACET type="minLength">1</FT_FACET>
    <FT_FACET type="maxLength">20</FT_FACET>
  </FT_FACETS>
</FEATURE_CONTENT>
  
```

Example 2: Floating-point number

The value of the feature is a floating-point number, which is in the interval $]-5,5]$ and has no more than 4 digits and 2 decimal places.

```
<FEATURE_CONTENT>
  <FT_DATATYPE>float</FT_DATATYPE>
  <FT_FACETS>
    <FT_FACET type="minExclusive">-5</FT_FACET>
    <FT_FACET type="maxInclusive">5</FT_FACET>
    <FT_FACET type="totalDigits">4</FT_FACET>
    <FT_FACET type="fractionDigits">2</FT_FACET>
  </FT_FACETS>
</FEATURE_CONTENT>
```

FT_FACET

(Data type restriction) namespace: BMECAT

This element defines a restriction on a data type, e.g., maximum length of a character string.



New element



General

Used in	Default value	Data type	Field length	Lang. specific	l.chg. in ver.
FT_FACETS	-	dtSTRING	20	-	2005fd

Attributes

Designation	Attribute name	Mandatory/optional	Explanation	Default value	Data type	Field length	Lang. specific	l.chg. in ver.
Restriction type	type	Mandatory	This attribute contains the type of the restriction. See also: Permitted values for attribute "type"	-	dtSTRING	20	-	2005fd

Permitted values for attribute "type"

Designation	Attribute value	Explanation	l.chg. in ver.
Minimum length	minLength	Defines the minimum length of all string data types, i.e. 'alphanumeric', 'set-alphanumeric' or 'string'.	2005fd
Maximum length	maxLength	Defines the maximum length of string data types, i.e. 'alphanumeric', 'set-alphanumeric' or 'string'.	2005fd
Included lower bound	minInclusive	Defines the included lower bound of numeric data types, i.e. 'count', 'float', 'integer', 'number', 'numeric', 'range-inter', 'range-numeric', 'set-integer' or 'set-numeric'.	2005fd
Included upper bound	maxInclusive	Defines the included upper bound of numeric data types, i.e. 'count', 'float', 'integer', 'number', 'numeric', 'range-inter', 'range-numeric', 'set-integer' or 'set-numeric'.	2005fd
Excluded lower bound	minExclusive	Defines the excluded lower bound of numeric data types, i.e. 'count', 'float', 'integer', 'number', 'numeric', 'range-inter', 'range-numeric', 'set-integer' or 'set-numeric'.	2005fd
Excluded upper bound	maxExclusive	Defines the excluded upper bound of numeric data types, i.e. 'count', 'float', 'integer', 'number', 'numeric', 'range-inter', 'range-numeric', 'set-integer' or 'set-numeric'.	2005fd
Digits	totalDigits	Defines the maximum number of digits of numeric data types, i.e. 'count', 'float', 'integer', 'number', 'numeric', 'range-integer', 'range-numeric', 'set-integer' oder 'set-numeric'.	2005fd

Permitted values for attribute "type"

Designation	Attribute value	Explanation	l.chg. in ver.
Decimal places	fractionDigits	Defines the maximum number of decimal places.	2005fd

FT_VALUES

(Feature domain values) *namespace: BMECAT*

This element contains a list of allowed values for the feature (only available for enumerative features).



New element

This element was named **FT_DOMAIN_VALUES** and is now named **FT_VALUES**. The sub-element **FT_DOMAIN_VALUE** was renamed to **FT_VALUE**.

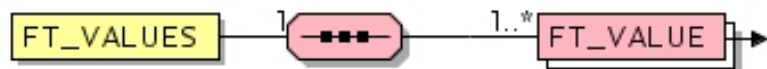

General

Used in	Default value	Data type	Field length	Lang. specific	l.chg. in ver.
FEATURE_CONTENT	-	-	-	-	2005

Elements

Designation	Element name	Mandatory/Optional	Single/Multiple	Explanation	Default value	Data type	Field length	Lang. specific	l.chg. in ver.
Feature value	FT_VALUE	Mandatory	Multiple	Value being part of the list of values for this feature <i>namespace: BMECAT</i> 	-	-	-	-	2005

FT_VALUE

(Feature value) namespace: BMECAT

This element defines a value as part of the list of values for this feature



New element



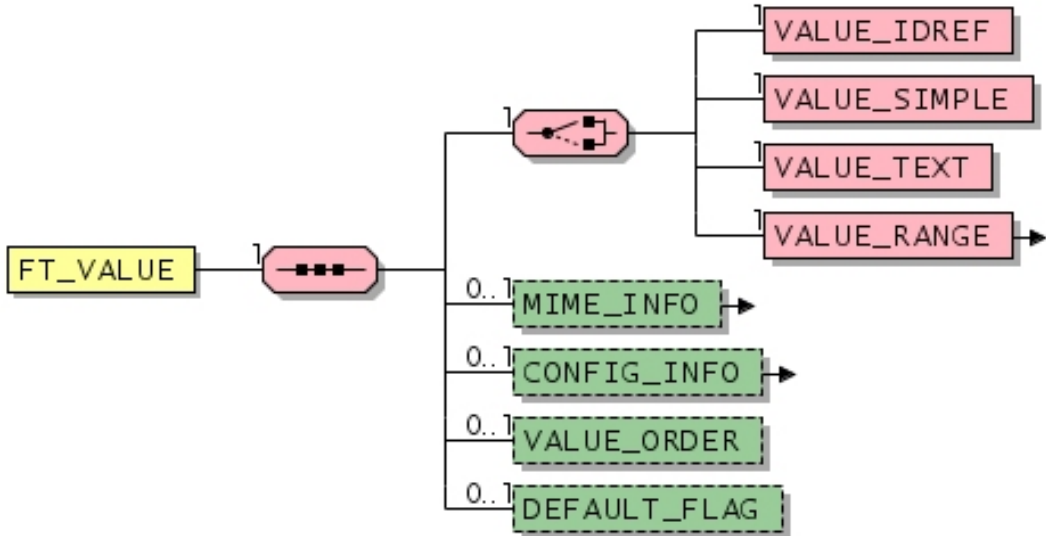



This element was named **FT_DOMAIN_VALUE** in BMEcat 2005 final draft, now it is named **FT_VALUE**.



General

Used in	Default value	Data type	Field length	Lang. specific	l.chg. in ver.
FT_VALUES	-	-	-	-	2005

Elements

Designation	Element name	Mandatory/Optional	Single/Multiple	Explanation	Default value	Data type	Field length	Lang. specific	l.chg. in ver.
Reference to a value	VALUE_IDREF	Mandatory	Single	Reference to the unique identifier of a value. The reference must point to a value defined in the document (element ALLOWED_VALUE identified by ALLOWED_VALUE_ID). This element can only be used for defining features of a classification system; it can not be used for defining features directly for products (PRODUCT_FEATURES) or for configurations (CONFIG_FEATURE). <i>namespace: BMECAT</i>  New element	-	dt STRING	60	-	2005fd
Atomic value	VALUE_SIMPLE	Mandatory	Single	A single, atomic value <i>namespace: BMECAT</i>  New element	-	dt STRING	80	-	2005fd
Text value	VALUE_TEXT	Mandatory	Single	This element contains a text. <i>namespace: BMECAT</i>  New element	-	dt ML-STRING	80	Yes	2005fd
Interval of values	VALUE_RANGE	Mandatory	Single	Definition of an interval of values <i>namespace: BMECAT</i>  New element	-	-	-	-	2005fd
Additional multimedia information	MIME_INFO	Optional	Single	Information about multimedia files For example an illustration which clarifies the value could be added here. <i>namespace: BMECAT</i>	-	-	-	-	-
Configuration information	CONFIG_INFO	Optional	Single	Information on creating order numbers and prices if the enumerative value is subject of product configuration. <i>namespace: BMECAT</i>  TODO.  New element	-	-	-	-	2005fd
Value order	VALUE_ORDER	Optional	Single	The order determines how a list of values is presented in target systems, beginning with the lowest number. <i>namespace: BMECAT</i>  New element	-	dt INTEGER	-	-	2005fd

Elements										
Designation	Element name	Mandatory/Optional	Single/Multiple	Explanation	Default value	Data type	Field length	Lang. specific	l.chg. in ver.	
Default flag	DEFAULT_FLAG	Optional	Single	Sets the default value of a list of values <i>namespace: BMECAT</i>  New element	-	dt BOO-LEAN	-	-	2005fd	

VALUE_RANGE

(Interval of values) *namespace: BMECAT*

This element defines an interval of values.



New element

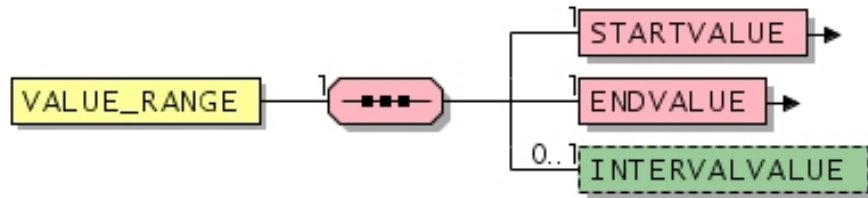

General

Used in	Default value	Data type	Field length	Lang. specific	l.chg. in ver.
FT_VALUE	-	-	-	-	2005fd

Elements

Designation	Element name	Mandatory/Optional	Single/Multiple	Explanation	Default value	Data type	Field length	Lang. specific	l.chg. in ver.
Start value	STARTVALUE - intervaltype	Mandatory	Single	Start value of the interval; the value is part of the interval. <i>namespace: BMECAT</i> 	-	dtNUMBER	-	-	2005fd
End value	ENDVALUE - intervaltype	Mandatory	Single	End value of the interval; the value is part of the interval. <i>namespace: BMECAT</i> 	-	dtNUMBER	-	-	2005fd
Distance of values	INTERVALVALUE	Optional	Single	Distance between the values in an interval of discrete values. For instance, a domain for the values 110, 120, 130, ... 220 can be defined by setting the start and end values (110 and 120) and adding the distance (10). <i>namespace: BMECAT</i> New element	-	dtNUMBER	-	-	2005fd

STARTVALUE

(Start value) namespace: BMECAT

This element sets the start value of the interval, thus the lower bound that is part of the interval.



New element



General

Used in	Default value	Data type	Field length	Lang. specific	l.chg. in ver.
VALUE_RANGE	-	dtNUMBER	-	-	2005fd

Attributes

Designation	Attribute name	Mandatory/optional	Explanation	Default value	Data type	Field length	Lang. specific	l.chg. in ver.
Interval type	intervaltype	Optional	This attribute indicates whether the value is part of the domain or not See also: Permitted values for attribute "intervaltype"	include	dtSTRING	20	-	2005fd

Permitted values for attribute "intervaltype"

Designation	Attribute value	Explanation	l.chg. in ver.
Value excluded	exclude	Indicates that the value is not part of the domain	2005fd
Value included	include	Indicates that the value is part of the domain	2005fd

ENDVALUE

(End value) namespace: BMECAT

This element sets the end value of the interval, thus the upper bound that is part of the interval.



New element

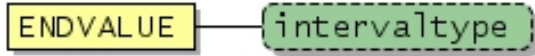

General

Used in	Default value	Data type	Field length	Lang. specific	l.chg. in ver.
VALUE_RANGE	-	dtNUMBER	-	-	2005fd

Attributes

Designation	Attribute name	Mandatory/optional	Explanation	Default value	Data type	Field length	Lang. specific	l.chg. in ver.
Interval type	intervaltype	Optional	This attribute indicates whether the value is part of the domain or not See also: Permitted values for attribute "intervaltype"	include	dtSTRING	20	-	2005fd

Permitted values for attribute "intervaltype"

Designation	Attribute value	Explanation	l.chg. in ver.
Value excluded	exclude	Indicates that the value is not part of the domain	2005fd
Value included	include	Indicates that the value is part of the domain	2005fd

FT_SYNONYMS

(Feature synonyms) *namespace: BMECAT*

This element contains a list of synonyms for the feature name.



New element

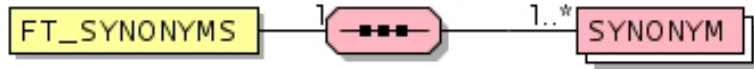

General

Used in	Default value	Data type	Field length	Lang. specific	l.chg. in ver.
FEATURE_CONTENT	-	-	-	-	2005fd

Elements

Designation	Element name	Mandatory/Optional	Single/Multiple	Explanation	Default value	Data type	Field length	Lang. specific	l.chg. in ver.
Synonym	SYNONYM	Mandatory	Multiple	The synonym support name-based product search. <i>namespace: BMECAT</i>  The maximum length has been extended from 60 characters to 80 characters.	-	dtML-STRING	80	Yes	2005fd

FT_SOURCE

(Feature source) *namespace: BMECAT*

This element contains the source for the feature definition which has been given in the **FT_DESCR** element; e.g. a reference to a document, standard or definition describing the feature.



New element

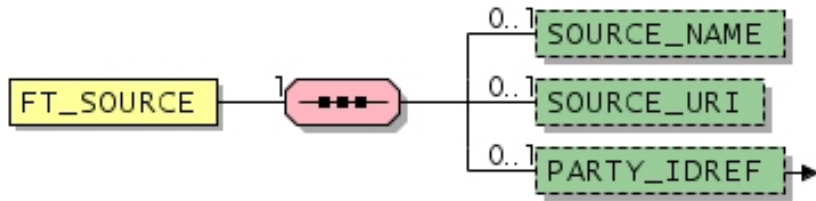

The sub-element **SOURCE_DESCR** was renamed to **SOURCE_NAME**.



General

Used in	Default value	Data type	Field length	Lang. specific	I.chg. in ver.
FEATURE_CONTENT	-	-	-	-	2005

Elements

Designation	Element name	Mandatory/Optional	Single/Multiple	Explanation	Default value	Data type	Field length	Lang. specific	I.chg. in ver.
Source description	SOURCE_NAME	Optional	Single	Description of the source, e.g., the name of the document or standard <i>namespace: BMECAT</i>  New element This element was named SOURCE_DESCR in Version 2005 final draft, now it is named SOURCE_NAME . The maximum length has been reduced from 250 characters to 80 characters.	-	dtML-STRING	80	Yes	2005
URI of the source	SOURCE_URI	Optional	Single	URI of the source, e.g., pointing to the document or standard <i>namespace: BMECAT</i>  New element	-	dtSTRING	255	-	2005fd

Elements										
Designation	Element name	Mandatory/Optional	Single/Multiple	Explanation	Default value	Data type	Field length	Lang. specific	l.chg. in ver.	
Reference to a business partner	PARTY_IDREF - type	Optional	Single	Reference to a business partner. It contains the unique identifier (PARTY_ID) of the respective party (element PARTY). In this context the element is used to reference the organisation which is responsible for the specification of the element. <i>namespace: BMECAT</i> 	-	dtSTRING	250	-	2005fd	

PARTY_IDREF

(Reference to a business partner) *namespace: BMECAT*

This element provides a reference to a business partner. It contains the unique identifier (**PARTY_ID**) of the respective party (element **PARTY**).



New element

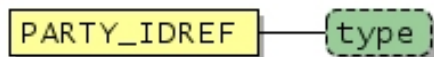

General

Used in	Default value	Data type	Field length	Lang. specific	l.chg. in ver.
FT_SOURCE	-	dtSTRING	250	-	2005fd

Attributes

Designation	Attribute name	Mandatory/optional	Explanation	Default value	Data type	Field length	Lang. specific	l.chg. in ver.
Coding standard	type	Optional	This attribute is used to state the coding standard to which the identifier (PARTY_ID) adheres. The most common coding standards are predefined. See also: Predefined values for attribute "type"	-	dtSTRING	250	-	1.2_fd

Predefined values for attribute "type"

Designation	Attribute value	Explanation	l.chg. in ver.
Buyer-specific number	buyer_specific	Identification number defined by the buyer	-
Customer specific number	customer_specific	Identification number defined by the customer	2005fd
Dun & Bradstreet	duns	DUNS-Number (see also http://dbuk.dnb.com/english/DataBase/duns.htm)	-
Global location number	iln	Internationally called GLN (see GLN below)	-
Global location number	gln	Global Location Number GLN (see also http://www.ean-int.org/locations.html)	2005fd
Party-specific number	party_specific	Identification number defined by the respective party	2005fd
Supplier-specific number	supplier_specific	Identification number defined by the supplier	-
Other codification standard	User defined value, format: \w{1,250}	Identificator of codification standard. "\w{1,250}" means that the identificator of the codification standard has to be at least 1 character long up to a maximum of 250 characters.	-

PRODUCT_COMPONENTS

(Product components)

List of product componentes contained in a product.



New element

Sub-element **PRODUCT_COMPONENT** can appear unbounded now.

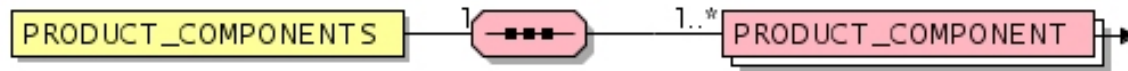

General

Used in	Default value	Data type	Field length	Lang. specific	l.chg. in ver.
ORDER_ITEM, PRODUCT_COMPONENT	-	-	-	-	21fd

Elements

Designation	Element name	Mandatory/Optional	Single/Multiple	Explanation	Default value	Data type	Field length	Lang. specific	l.chg. in ver.
Product component	PRODUCT_COMPONENT	Mandatory	Multiple	Products which are part of other products and need to be further specified 	-	-	-	-	21fd

PRODUCT_COMPONENT

(Product component)

Products which are part of other products are specified via this element.



Product components with related price informations only have an informative character. Prices related to product components are not used to integrate in the price calculation of the higher level product.



New element
Example added.

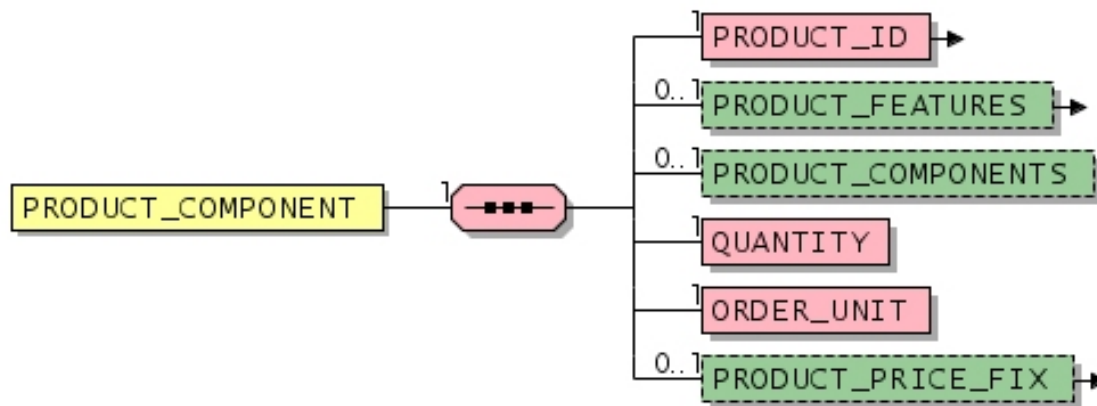



General

Used in	Default value	Data type	Field length	Lang. specific	l.chg. in ver.
PRODUCT_COMPONENTS	-	-	-	-	21fd

Elements

Designation	Element name	Mandatory/Optional	Single/Multiple	Explanation	Default value	Data type	Field length	Lang. specific	l.chg. in ver.
Product number	PRODUCT_ID	Mandatory	Single	Identifier of the product. The included elements ensure the capability of a unique identification of a product. 	-	-	-	-	21fd

Elements

Designation	Element name	Mandatory/Optional	Single/Multiple	Explanation	Default value	Data type	Field length	Lang. specific	l.chg. in ver.
Product features	PRODUCT_FEATURES	Optional	Single	Description of the product by features and/or classification of the product 	-	-	-	-	21fd
Product components	PRODUCT_COMPONENTS	Optional	Single	List of product components contained in a product.  New element Sub-element PRODUCT_COMPONENT can appear unbounded now.	-	-	-	-	21fd
Quantity	QUANTITY	Mandatory	Single	Quantity	-	dtNUMBER	-	-	2.0
Order unit	ORDER_UNIT	Mandatory	Single	Unit in which the product can be ordered; it is only possible to order multiples of the product unit. The price also always refers to this unit (or to part of or multiples of it). Example: Crate of mineral water with 6 bottles Order unit: "crate", contents unit/unit of the article: "bottle" Packing quantity: "6" <i>namespace: BMECAT</i>	-	dtPUNIT	-	-	-
Determined product price	PRODUCT_PRICE_FIX	Optional	Single	A fixed product price 	-	-	-	-	20v1

Example

```

<PRODUCT_COMPONENT>
  <PRODUCT_ID>
    <bmeecat: SUPPLIER_PID>T-38</bmeecat: SUPPLIER_PID>
    <bmeecat: DESCRIPTION_SHORT>Notebookbag</bmeecat: DESCRIPTION_SHORT>
  </PRODUCT_ID>
  <QUANTITY>4</QUANTITY>
  <bmeecat: ORDER_UNIT>BG</bmeecat: ORDER_UNIT>
</PRODUCT_COMPONENT>

```

PRODUCT_PRICE_FIX

(Determined product price)

The element specifies a fixed price related to a product. In contrast to the element **PRICE_LINE_AMOUNT** the fixed product price does not contain any dynamic/variable decision opportunities (like graduated prices in relation to the ordered quantity). Therefore the element specifies a value not a price policy. The element should only be used in documents where usually price-information is contained (e.g. invoice).



New element

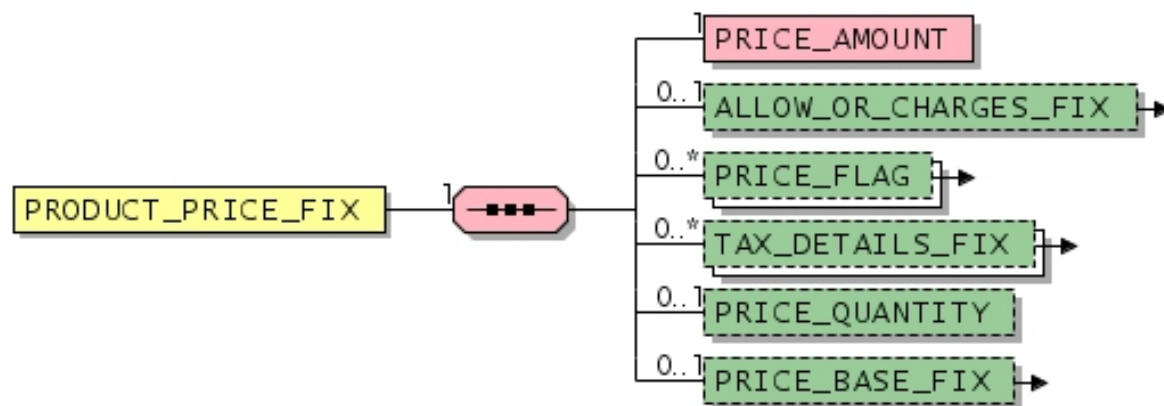



General

Used in	Default value	Data type	Field length	Lang. specific	l.chg. in ver.
ORDER_ITEM, PRODUCT_COMPONENT	-	-	-	-	20v1

Elements

Designation	Element name	Mandatory/Optional	Single/Multiple	Explanation	Default value	Data type	Field length	Lang. specific	l.chg. in ver.
Price amount	PRICE_AMOUNT	Mandatory	Single	Amount of the price <i>namespace: BMECAT</i>	-	dtNUMBER	-	-	-
Fixed allowance or surcharges	ALLOW_OR_CHARGES_FIX	Optional	Single	A list of fixed allowances or surcharges which are to be applied on the price. 	-	-	-	-	21fd
Price flag	PRICE_FLAG - type	Optional	Multiple	Base of a price (e.g. with/without freight) <i>namespace: BMECAT</i>	-	dtBOOLEAN	-	-	-

Elements										
Designation	Element name	Mandatory/ Optional	Single/ Multiple	Explanation	Default value	Data type	Field length	Lang. specific		I.chg. in ver.
Tax details	TAX_DETAILS_FIX	Optional	Multiple	Information to an applied tax 	-	-	-	-		20v1
Price quantity	PRICE_QUANTITY	Optional	Single	If nothing is specified in this field the default value 1 is assumed, in other words the price refers to exactly one order unit. If specified, a multiple or a fraction of the order unit (element ORDER_UNIT) which indicates the quantity to which all the specified prices refer. Example: 10 (i.e. the specified price refers to 10 crates) <i>namespace: BMECAT</i>  A default value was added.	1	dtNUM- BER	-	-		2005
Fixed price base	PRICE_BASE_FIX	Optional	Single	Specifies the calculation of a price 	-	-	-	-		20v1

PRICE_FLAG

(Price flag) namespace: BMECAT

This element is used to specify the base of a price (e.g. with/without freight)

Where these fields have not been filled out, no statement on the various components of the price base will be made.

Example: `<PRICE_FLAG type="incl_freight">true</PRICE_FLAG>` means that freight costs are included in the related price. `<PRICE_FLAG type="incl_freight">false</PRICE_FLAG>` means that the freight costs are not included in the related price. Where the element PRICE_FLAG does not occur with the attribute "incl_freight", there is no indication of whether the prices are with or without freight. This must therefore be stipulated elsewhere (e.g. in the skeleton agreement).



General

Used in	Default value	Data type	Field length	Lang. specific	l.chg. in ver.
PRODUCT_PRICE_FIX	-	dtBOO-LEAN	-	-	-

Attributes

Designation	Attribute name	Mandatory/optional	Explanation	Default value	Data type	Field length	Lang. specific	l.chg. in ver.
Type of costs included	type	Mandatory	This attribute specifies the pool of costs which have an indication of whether or not they contribute to price formation.  The list of values can now be extended. The list here contains only the predefined values. See also: Predefined values for attribute "type"	-	dtSTRING	20	-	2005fd

Predefined values for attribute "type"

Designation	Attribute value	Explanation	l.chg. in ver.
Including insurance	incl_assurance	Price includes insurance This value has been replaced by the new value PRICE_FLAG -->type =incl_insurance , it will be become obsolete.	-
Including duty	incl_duty	Price includes duty	-
Including freight	incl_freight	Price includes freight costs	-
Including insurance	incl_insurance	Price includes insurance	2005fd

Predefined values for attribute "type"

Designation	Attribute value	Explanation	l.chg. in ver.
Including packing	incl_packing	Price includes packing costs	-
User defined type	User defined value, format: \w{1,20}	User defined type identification. "\w{1,20}" means that the type identification has to be at least 1 character long up to a maximum of 20 characters.	2005fd

TAX_DETAILS_FIX

(Tax details)

This element contains information of one applicable tax.





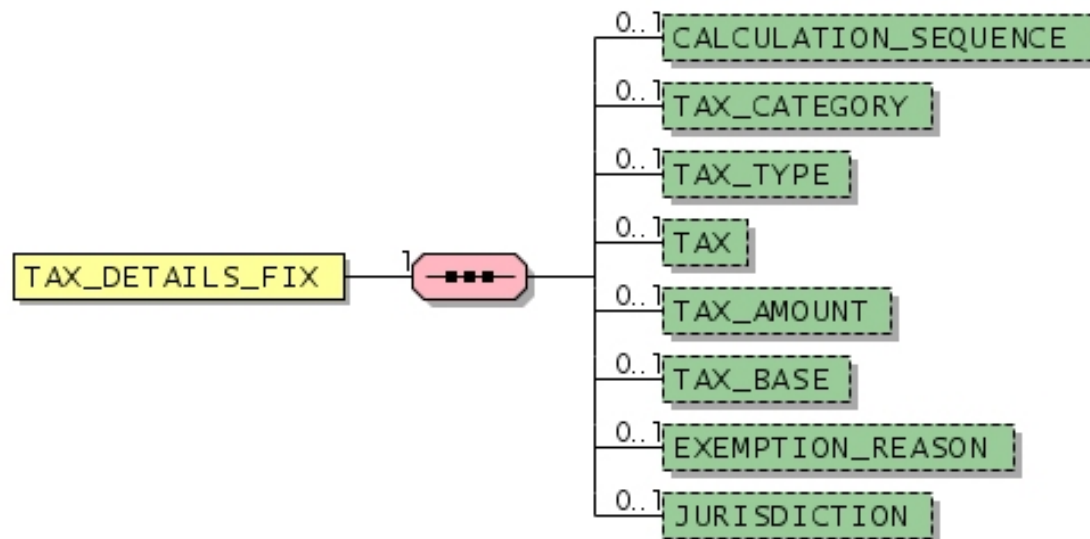

New element



General

Used in	Default value	Data type	Field length	Lang. specific	l.chg. in ver.
PRODUCT_PRICE_FIX	-	-	-	-	20v1

Elements

Designation	Element name	Mandatory/ Optional	Single/ Multiple	Explanation	Default value	Data type	Field length	Lang. specific	l.chg. in ver.
Calculation sequence	CALCULATION_SEQUENCE	Optional	Single	This element determines the sequence for applying multiple taxes to a basis. The taxes must be applied beginning with the lowest value in CALCULATION_SEQUENCE . Therefore, the tax with the lowest sequence will be calculated first, then follows the tax with the next higher sequence, and so on. If two taxes have the same sequence, both tax factors must be added prior to calculation. <i>namespace: BMECAT</i>  New element	1	dtCOUNT	-	-	2005
Tax category	TAX_CATEGORY	Optional	Single	This element specifies the tax category as a code. By this it is possible to define the tax not as an absolute value, but as the currently valid percentage (TAX). The specification should take place, if possible, by using a common code. The list of predefined values contains codes that should be used within the European Union (see also http://europa.eu.int/comm/taxation_customs/taxation/vat/how_vat_works/rates/index_en.htm). <i>namespace: BMECAT</i>  New element See also: Predefined values for element TAX_CATEGORY	-	dtSTRING	80	-	2005
Tax type	TAX_TYPE	Optional	Single	This element specifies the tax type; it should take place by using internationally accepted terms, such as VAT for value added tax. <i>namespace: BMECAT</i>  New element	vat	dtSTRING	250	-	2005
Tax rate	TAX	Optional	Single	Factor for tax applicable to this price. Example: "0.16", corresponds to 16 percent. <i>namespace: BMECAT</i>	-	dtNUMBER	-	-	-
Tax amount	TAX_AMOUNT	Optional	Single	Total amount of the tax to be paid. Is the result of multiplying the price and the tax rate (TAX) and is listed explicitly for tax reasons. This amount is related to one item-position.	-	dtNUMBER	-	-	-
Tax base	TAX_BASE	Optional	Single	If used this element specifies the base for the calculation of the tax.  New element	-	dtNUMBER	-	-	20fd
Exemption reason	EXEMPTION_REASON	Optional	Single	This element gives the reason why the tax is an exemption from the norm. <i>namespace: BMECAT</i>  New element	-	dtML-STRING	250	Yes	2005

Elements

Designation	Element name	Mandatory/ Optional	Single/ Multiple	Explanation	Default value	Data type	Field length	Lang. specific	l.chg. in ver.
Jurisdiction	JURISDICTION	Optional	Single	Tax jurisdiction <i>namespace: BMECAT</i>  New element	-	dtML- STRING	250	Yes	2005

Predefined values for element TAX_CATEGORY

Designation	Element value	Explanation	l.chg. in ver.
Exemption	exemption	The item is free of tax.	2005
Parking rate	parking_rate	The tax is a parking rate.	2005
Reduced rate	reduced_rate	The tax is a reduced rate.	2005
Standard rate	standard_rate	The tax is the standard rate.	2005
Super reduced rate	super_reduced_rate	The tax is a super reduced rate.	2005
Zero rate	zero_rate	The tax is the zero rate.	2005
Other, user-defined category	User defined value, format: [w\-\.]{1,80}	The specification of the tax category should take place by commonly used codes. The code should have at least 1 character and 80 characters at the maximum.	2005

PRICE_BASE_FIX

(Fixed price base)

The element specifies on how the price is calculated based on the price-base. The calculation relies on the price-factor, the price-unit and the amount/number of supplied price-units.



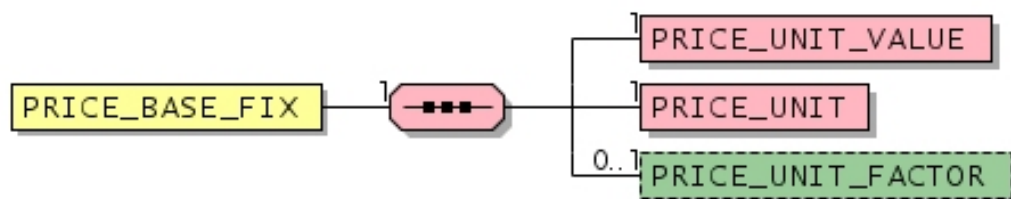

New element



General

Used in	Default value	Data type	Field length	Lang. specific	l.chg. in ver.
PRODUCT_PRICE_FIX	-	-	-	-	20v1

Elements

Designation	Element name	Mandatory/Optional	Single/Multiple	Explanation	Default value	Data type	Field length	Lang. specific	l.chg. in ver.
Number of price units	PRICE_UNIT_VALUE	Mandatory	Single	Number of supplied price units. In the case of product prices not related to an order unit the total price of an item-line (PRICE_LINE_AMOUNT) is calculated using a price unit. Then the calculation of the total price of an item-line is the result of the multiplication of PRICE_UNIT_VALUE and PRICE_AMOUNT .  New element	-	dtFLOAT	-	-	20v1
Price unit	PRICE_UNIT	Mandatory	Single	Unit of measurement on which the price is calculated <i>namespace: BMECAT</i>  New element	-	dtPUNIT	-	-	2005fd
Price unit factor	PRICE_UNIT_FACTOR	Optional	Single	The price factor is the conversion factor for price unit and order unit. The underlying formula is: PRICE_UNIT equals PRICE_UNIT_FACTOR * ORDER_UNIT <i>namespace: BMECAT</i>  New element A default value was added.	1	dtFLOAT	-	-	2005

PARTIAL_DELIVERY_LIST

(Partial shipment list)

The element contains information related to items of outstanding partial shipments. Every partial shipment supposes a **PARTIAL_DELIVERY** element containing the expected delivery date (**DELIVERY_DATE**) and quantity (**QUANTITY**).



The element is only allowed to be used if the element **DELIVERY_COMPLETED** specifies the value 'FALSE'.



New element

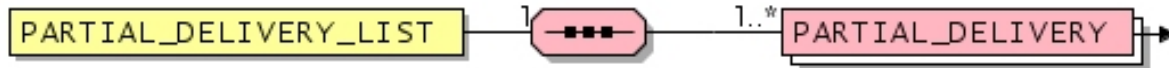

General

Used in	Default value	Data type	Field length	Lang. specific	l.chg. in ver.
ORDER_ITEM	-	-	-	-	20v2

Elements

Designation	Element name	Mandatory/Optional	Single/Multiple	Explanation	Default value	Data type	Field length	Lang. specific	l.chg. in ver.
Partial shipment	PARTIAL_DELIVERY	Mandatory	Multiple	Information to a partial shipment 	-	-	-	-	20v2

PARTIAL_DELIVERY

(Partial shipment)

The element specifies the expected shipment date (**DELIVERY_DATE**) and the planned quantity (**QUANTITY**) according to an outstanding partial shipment.



New element

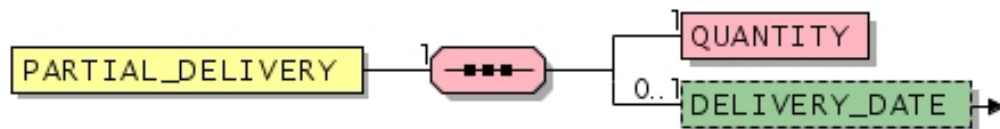

General

Used in	Default value	Data type	Field length	Lang. specific	l.chg. in ver.
PARTIAL_DELIVERY_LIST	-	-	-	-	20v2

Elements

Designation	Element name	Mandatory/Optional	Single/Multiple	Explanation	Default value	Data type	Field length	Lang. specific	l.chg. in ver.
Quantity	QUANTITY	Mandatory	Single	Quantity	-	dtNUMBER	-	-	2.0
Delivery date	DELIVERY_DATE - type	Optional	Single	Date of shipment. The delivery date specifies the date the commissioned goods are accepted by the buyer. If the delivery date deviates from the one specified in the header, the delivery date on item level is valid. To specify exact one date for the shipment, e.g. in the RECEIPTACKNOWLEDGEMENT-document, both sub-elements the DELIVERY_DATE and the DELIVERY_END_DATE should be the equal. 	-	-	-	-	21fd

ACCOUNTING_INFO

(Accounting information) *namespace: BMECAT*

This element contains information about accounting processes which occur at the buying company as a result of the order. This information includes the number of the identification of the cost category concerned, the type of cost as well as the actual account. The accounting information is given by the buying company so that the supplier can indicate it on the invoice, which in turn facilitates checking and auditing invoices at the buying company.



New element

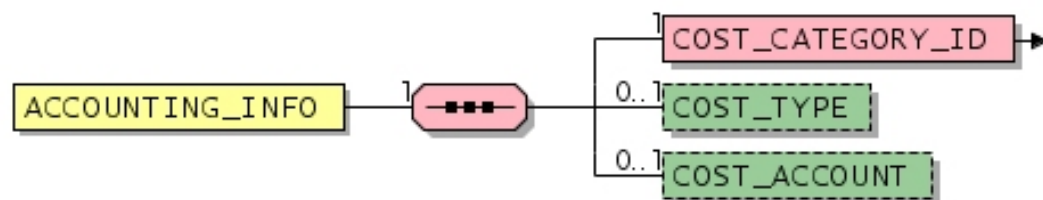

General

Used in	Default value	Data type	Field length	Lang. specific	I.chg. in ver.
ORDER_ITEM	-	-	-	-	2005fd

Elements

Designation	Element name	Mandatory/Optional	Single/Multiple	Explanation	Default value	Data type	Field length	Lang. specific	I.chg. in ver.
Cost category	COST_CATEGORY_ID - type	Mandatory	Single	Number of the cost center to be charged or the project or work order to which the charge must be made. The type of cost category is fixed by the attribute "type". <i>namespace: BMECAT</i> New element	-	dtSTRING	64	-	2005fd
Type of cost	COST_TYPE	Optional	Single	Information about the type of cost, e.g. investment, service, consumption, etc. <i>namespace: BMECAT</i> New element	-	dtSTRING	64	-	2005fd
Cost account	COST_ACCOUNT	Optional	Single	Number of the main account to be charged <i>namespace: BMECAT</i> New element	-	dtSTRING	64	-	2005fd

COST_CATEGORY_ID

(Cost category) namespace: BMECAT

Number of the cost center to be charged or the project or work order to which the charge must be made.

The type of cost category is fixed by the attribute "type".



New element



General

Used in	Default value	Data type	Field length	Lang. specific	l.chg. in ver.
ACCOUNTING_INFO	-	dtSTRING	64	-	2005fd

Attributes

Designation	Attribute name	Mandatory/optional	Explanation	Default value	Data type	Field length	Lang. specific	l.chg. in ver.
Type of cost category	type	Optional	It is specified here whether the costs are to be charged to a cost center, project or work order. If the attribute is not used no exact specification is made. See also: Permitted values for attribute "type"	-	dtSTRING	20	-	2005fd

Permitted values for attribute "type"

Designation	Attribute value	Explanation	l.chg. in ver.
Cost center	cost_center	The costs are charged to a cost center.	2005fd
Project	project	The costs are charged to a project.	2005fd
Work order	work_order	The costs are charged to a work order.	2005fd

SPECIAL_TREATMENT_CLASS(Special treatment class) *namespace: BMECAT*

This elements contains an additional product classification used for hazardous goods or substances, primary pharmaceutical products, radioactive measuring equipment, etc. The "type" attribute specifies the dangerous goods classification scheme.

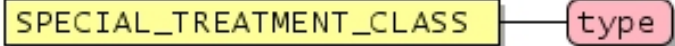
**General**

Used in	Default value	Data type	Field length	Lang. specific	l.chg. in ver.
ORDER_ITEM	-	dtSTRING	20	-	-

Attributes

Designation	Attribute name	Mandatory/optional	Explanation	Default value	Data type	Field length	Lang. specific	l.chg. in ver.
Name of the special treatment rule	type	Mandatory	Short term for the special treatment regulation, e.g., GGVS (Hazardous Goods Order for Road Traffic)	-	dtSTRING	50	-	-

Example

(Hazardous Goods Order for Road Traffic, heating oil)

```
<SPECIAL_TREATMENT_CLASS type="GGVS">1201</SPECIAL_TREATMENT_CLASS>
```

ORDER_SUMMARY

(Summary)

The summary contains information on the number of item lines in the order. This figure is used for control purposes to make sure that all items have been transferred.

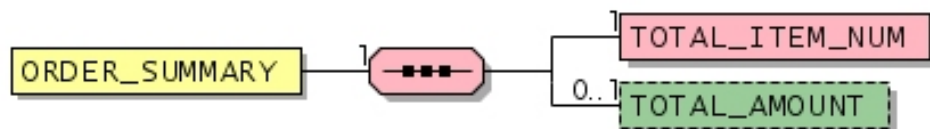

General

Used in	Default value	Data type	Field length	Lang. specific	l.chg. in ver.
ORDER	-	-	-	-	2.0

Elements

Designation	Element name	Mandatory/Optional	Single/Multiple	Explanation	Default value	Data type	Field length	Lang. specific	l.chg. in ver.
Number of item lines	TOTAL_ITEM_NUM	Mandatory	Single	Contains the total number of item lines in the business document. The information is redundant and is for the purposes of statistical evaluation (e.g. by an intermediary) if appropriate.	-	dtCOUNT	-	-	2.0
Total amount	TOTAL_AMOUNT	Optional	Single	<p>Total amount covering all items in this business document.</p> <p>⚠ Changed definition:</p> <p>Gross price including surcharges, deductions and all taxes. Where no price per item can be given as the item level (e.g. bills of materials where explosion is not possible), the total price can be entered here.</p> <p>⚠</p> <p>⚠ Changed definition</p>	-	dtNUMBER	-	-	20

Index

ACADEMIC_TITLE	59	CONFIG_INFO	158
ACCOUNT	67	CONTACT_DESCR	59
ACCOUNTING_INFO	180	CONTACT_DETAILS	58
ADDRESS	53	CONTACT_ID	59
ADDRESS_REMARKS	56	CONTACT_NAME	59
AGREEMENT	20	CONTACT_ROLE	61
AGREEMENT_DESCR	22	CONTROL_INFO	18
AGREEMENT_END_DATE	22	COST_ACCOUNT	180
AGREEMENT_ID	21	COST_CATEGORY_ID	181
AGREEMENT_LINE_ID	21	COST_TYPE	180
AGREEMENT_START_DATE	22	COUNTRY	55
ALLOW_OR_CHARGE	97	COUNTRY_CODED	56
ALLOW_OR_CHARGES_FIX	95	CURRENCY	41
ALLOW_OR_CHARGES_TOTAL_AMOUNT	95	CUSTOMER_IDREF	74
ALLOW_OR_CHARGE_BASE	98	CUSTOMER_ORDER_REFERENCE	72
ALLOW_OR_CHARGE_DESCR	98	DAYS	93
ALLOW_OR_CHARGE_NAME	98	DEBIT	87
ALLOW_OR_CHARGE_SEQUENCE	98	DEFAULT_FLAG	159
ALLOW_OR_CHARGE_TYPE	98	DELIVERER_IDREF	82
ALLOW_OR_CHARGE_VALUE	101	DELIVERY_DATE	43
AOC_ADDITIONAL_ITEMS	102	DELIVERY_END_DATE	44
AOC_MONETARY_AMOUNT	101	DELIVERY_IDREF	80
AOC_ORDER_UNITS_COUNT	103	DELIVERY_START_DATE	44
AOC_PERCENTAGE_FACTOR	101	DEPARTMENT	55
AUTHENTICATION	66	DESCRIPTION_LONG	120
BANK_ACCOUNT	69	DESCRIPTION_SHORT	119
BANK_CODE	71	DISCOUNT_FACTOR	94
BANK_COUNTRY	68	DOEXCHANGE_PARTIES_REFERENCE	83
BANK_NAME	68	DOCUMENT_ISSUER_IDREF	84
BOXNO	55	DOCUMENT_RECIPIENT_IDREF	85
BUYER_IDREF	76	EMAIL	64
BUYER_PID	125	EMAILS	64
CALCULATION_SEQUENCE	175	ENDVALUE	162
CARD	88	EXEMPTION_REASON	175
CARD_AUTH_CODE	89	FAX	63
CARD_EXPIRATION_DATE	89	FDESCR	137
CARD HOLDER_NAME	89	FEATURE	135
CARD_NUM	89	FEATURE_CONTENT	147
CARD_REF_NUM	89	FILE_HASH_VALUE	32
CASH	87	FILE_NAME	35
CATALOG_ID	37	FILE_SIZE	35
CATALOG_NAME	37	FINAL_DELIVERY_IDREF	81
CATALOG_REFERENCE	37	FIRST_NAME	59
CATALOG_VERSION	37	FNAME	136
CENTRAL_REGULATION	87	FORDER	137
CHECK	87	FTEMPLATE	141
CITY	55	FT_DATATYPE	148
CONFIG_CODE_FIX	118	FT_DEPENDENCIES	146



FT_DESCR	142
FT_FACET	154
FT_FACETS	152
FT_GROUP_IDREF	142
FT_GROUP_NAME	142
FT_ID	141
FT_IDREF	136
FT_MANDATORY	148
FT_NAME	142
FT_NOTE	149
FT_ORDER	149
FT_REMARK	149
FT_SHORTNAME	142
FT_SOURCE	164
FT_SYMBOL	149
FT_SYNONYMS	163
FT_UNIT	148
FT_UNIT_IDREF	148
FT_VALENCY	148
FT_VALUE	157
FT_VALUES	156
FT_VERSION	144
FUNIT	137
FVALUE	136
FVALUE_DETAILS	138
FVALUE_TYPE	138
GENERATION_DATE	18
GENERATOR_INFO	18
GROUP_PRODUCT_ORDER	130
HEADER_UDX	42
HOLDER	67
INCOTERM	104
INTERNATIONAL_PID	124
INTERNATIONAL_RESTRICTIONS	105
INTERVALVALUE	160
INVOICE_RECIPIENT_IDREF	77
ITEM_UDX	114
JURISDICTION	176
LANGUAGE	45
LINE_ITEM_ID	72
LOCATION	104
LOGIN	66
LOT_NUMBER	118
MANUFACTURER_IDREF	127
MANUFACTURER_INFO	126
MANUFACTURER_PID	126
MANUFACTURER_TYPE_DESCR	126
MIME	26
MIME_ALT	27
MIME_DATA	36

MIME_DESCR	27
MIME_EMBEDDED	34
MIME_INFO	24
MIME_ORDER	28
MIME_PURPOSE	28
MIME_ROOT	40
MIME_SOURCE	27
MIME_TYPE	27
NAME	55
NAME2	55
NAME3	55
ORDER	15
ORDER_DATE	40
ORDER_DESCR	72
ORDER_HEADER	17
ORDER_ID	40
ORDER_INFO	38
ORDER_ITEM	109
ORDER_ITEM_LIST	108
ORDER_PARTIES_REFERENCE	75
ORDER_SUMMARY	183
ORDER_UNIT	169
ORIGINAL_DATE	145
PARTIAL_DELIVERY	179
PARTIAL_DELIVERY_LIST	178
PARTIAL_SHIPMENT_ALLOWED	41
PARTIES	46
PARTY	47
PARTY_ID	52
PARTY_IDREF	166
PARTY_ROLE	48
PASSWORD	66
PAYMENT	86
PAYMENT_DATE	93
PAYMENT_TERM	92
PAYMENT_TERMS	90
PHONE	62
PRICE_AMOUNT	170
PRICE_BASE_FIX	177
PRICE_FLAG	172
PRICE_LINE_AMOUNT	111
PRICE_QUANTITY	171
PRICE_UNIT	177
PRICE_UNIT_FACTOR	177
PRICE_UNIT_VALUE	177
PRODUCT_COMPONENT	168
PRODUCT_COMPONENTS	167
PRODUCT_FEATURES	128
PRODUCT_ID	117
PRODUCT_PRICE_FIX	170

PRODUCT_TYPE	120
PUBLIC_KEY	65
QUANTITY	169
QUOTATION_ID	19
REFERENCE_FEATURE_GROUP_ID	133
REFERENCE_FEATURE_GROUP_ID2	134
REFERENCE_FEATURE_GROUP_NAME	129
REFERENCE_FEATURE_SYSTEM_NAME	129
REMARKS	106
REVISION	144
REVISION_DATE	145
SERIAL_NUMBER	119
SHIPMENT_PARTIES_REFERENCE	79
SOURCE_NAME	164
SOURCE_URI	164
SOURCING_INFO	19
SPECIAL_TREATMENT_CLASS	182
STARTVALUE	161
STATE	55
STOP_AUTOMATIC_PROCESSING	18
STREET	55
SUPPLIER_IDREF	23
SUPPLIER_PID	122
SYNONYM	163
TAX	175
TAX_AMOUNT	175
TAX_BASE	175
TAX_CATEGORY	175
TAX_DETAILS_FIX	174
TAX_NUMBER	56
TAX_TYPE	175
TERMS_AND_CONDITIONS	41
TIME_FOR_PAYMENT	93
TITLE	59
TOTAL_AMOUNT	183
TOTAL_ITEM_NUM	183
TRANSPORT	104
TRANSPORT_REMARK	104
URL	60
VALUE_DATE	90
VALUE_IDREF	158
VALUE_ORDER	158
VALUE_RANGE	160
VALUE_SIMPLE	158
VALUE_TEXT	158
VAT_ID	56
VERSION	144
VERSION_DATE	144
ZIP	55
ZIPBOX	55



Annex

Basic data types

Designation	Data type name	Explanation	Underlying standards	Format	l.chg. in ver.
Boolean value	dtBOOLEAN	The values "true" or "false" can be entered, case-insensitive, i.e. regardless of capital or small letters. Examples: TRUE or true or True	Leaned on: XML Schema Part 2: Data types Second Edition W3C Recommendation 28 October 2004 Data type boolean http://www.w3.org/TR/xmlschema-2/#boolean		-
Integral positive number	dtCOUNT	Integral positive number. No fractions. No negative numbers. "0" is permitted. No separator for thousand is permitted  New data type Examples: 0; 1; 2; ...	XML Schema Part 2: Data types Second Edition W3C Recommendation 28 October 2004 Data type nonNegativeInteger http://www.w3.org/TR/xmlschema-2/#nonNegativeInteger		2005fd
Date and time	dtDATETIME	Date and optional time specification  This new data type replaces the following types: dtDATETYPE , dtTIMETYPE and dtTIME-ZONETYPE Examples: 2005-03-27T08:10:30+01:00 (corresponds to: March 27, 2005 08:10:30 CET); 2005-03; 2005-03-27; 2005-03-27T08:10	XML Schema Part 2: Data types Second Edition W3C Recommendation 28 October 2004 Data type dateTime http://www.w3.org/TR/xmlschema-2/#dateTime see also: ISO 8601: Representations of dates and times	yyyy-mm-ddThh:mm:ss+tt:00	2005fd
Floating-point number	dtFLOAT	Floating-point number in accordance with IEEE 754 The decimal separator is the dot. No separator for thousand is permitted. Examples: .314159265358979E+1 15.4	IEEE 754-1985: IEEE Standard for Binary Floating-Point Arithmetic siehe dazu auch: XML Schema Part 2: Data types Second Edition W3C Recommendation 28 October 2004 Data type float http://www.w3.org/TR/xmlschema-2/#float		-
Integer value	dtINTEGER	Whole number with an optional sign. No fractions. No floating-point numbers. No separator for thousand is permitted. Examples: 1; 58502; -13	XML Schema Part 2: Data types Second Edition W3C Recommendation 28 October 2004 Data type integer http://www.w3.org/TR/xmlschema-2/#integer		-

Designation	Data type name	Explanation	Underlying standards	Format	l.chg. in ver.
Multilingual string	dtMLSTRING	<p>This data type differs from the dtSTRING data type only in the additional "lang" attribute, which is added to the respective element. The "lang" attribute specifies the language of text used in the element. It has to be coded according to the dtLANG data type. This new data type allows multilingual catalogs, thus multilingual content (i.e. texts) can be transferred in a single BMEcat document (see also: Chapter: Multilingual Catalog Documents). In a multilingual document, all language-dependent elements of cardinality "single" may occur multiple, though the values of the "lang" attribute must be different.</p> <p>Examples: The short description in the DESCRIPTION_SHORT element is provided both in German and English . Note that the "lang" attribute in the second PRODUCT_DETAILS element is not necessary, if the default language of the catalog (CATALOG) has been set to German.</p> <pre><DESCRIPTION_SHORT lang="deu">Schraubendreher</DESCRIPTION_SHORT> <DESCRIPTION_SHORT lang="eng">Screw driver</DESCRIPTION_SHORT> ... <DESCRIPTION_SHORT>Bohrer</DESCRIPTION_SHORT> <DESCRIPTION_SHORT lang="eng">Drill</DESCRIPTION_SHORT></pre>			-
Number	dtNUMBER	<p>Numeric value. Used whenever a more specific numeric format is either not required or impractical. There are no restrictions regarding minimum or maximum values, the number of digits or the number of decimal places. The decimal separator is the dot. No separator for thousand is permitted.</p> <p>Right: 15 3.14 -123.456E+10</p> <p>Wrong: 13,20 1.000.000</p>			-
Character string	dtSTRING	<p>Character string according to the encoding standard (see also Chapter: Coding in XML)</p> <p>Example: Screw driver, yellow</p>			-

Enumeration data types

Designation	Data type name	Explanation	Underlying standards	Format	l.chg. in ver.
binary coded data	base64Binary	<p>This data type is used to transport an encoded file in openTRANS-XML-files. The file is not referred to by links but included in the XML-document. The file must be encoded according to the 'base64'-method. Further information can be found on http://www.ietf.org/rfc/rfc2045.txt. This data type is provided by the w3c and you can find further information on the embedding of files in XML-files at http://www.w3.org/TR/xml-media-types/.</p> <p> New data type</p>	<p>Describing Media Content of Binary Data in XML - W3C Working Group Note 4 May 2005 http://www.w3.org/TR/xml-media-types/</p>		20v3
Country codes	dtCOUNTRIES	<p>Country codes to indicate areas of availability (TERRITORY).</p> <p>The country subdivision codes can be used to subdivide country codes further, for example into regions.</p> <p>Examples: DE (Germany); US (USA) DE-NW (North-Rhine Westphalia in Germany) DK-025 (Roskilde Administrative District in Denmark)</p>	<p>ISO 3166-1 Country codes http://www.iso.org/iso/country_codes/iso_3166_code_lists.htm</p>	6 characters	-
Currency codes	dtCURRENCIES	<p>Currency codes to indicate currencies</p> <p>Examples: EUR (Euro); USD (US Dollar)</p>	<p>ISO 4217:1995 Currency codes [ISO-4217:1995] http://www.iso.org/iso/support/faqs/faqs_widely_used_standards/widely_used_standards_other/currency_codes/currency_codes_list-1.htm</p> <p> Since 1997 the code "EUR" instead of "XEU" has been in place for Euro. This is proscribed as the official code ISO 4217:2000. It is therefore urgently recommended that "EUR" be used as code for Euro.</p>	3 characters	-
Language codes	dtLANG	<p>Language codes to indicate the language used in texts or pictures</p> <p>Example: deu (German)</p>	<p>ISO 639-2:1998 Language code [ISO-639-2:1998] http://www.loc.gov/standards/iso639-2/php/code_list.php</p>	3 characters	-

Designation	Data type name	Explanation	Underlying standards	Format	l.chg. in ver.
Package unit codes	dtPUNIT	<p>Package unit codes: this list contains the permitted package units</p> <p>Example: C62 (piece)</p>	<p>UN/ECE Recommendation 20 / Package Units http://www.unece.org/cefact/recommendations/rec_index.htm</p> <p> The package unit codes have been defined in UN/ECE Recommendation 21 (Codes for types of cargo, packages and packaging materials), and the existing code entries in Recommendation 20 have been flagged for deletion. Due to compatibility, BMEcat 2005 sticks to the 3-letter-code of Recommendation 20. However, future versions of BMEcat may switch to Recommendation 21.</p>	maximal 3 characters	1.2_fd

Special data types

Designation	Data type name	Explanation	Underlying standards	Format	l.chg. in ver.
Header extension	udxHEADER	This data type is defined as empty; it serves for user-defined, thus non-open-TRANS-elements for extending the catalog header.			-
Item extension	udxITEM	This data type is defined as empty and serves for user-defined, thus non-open-TRANS-elements for describing on item level.			-

History of changes Version 2005fd

Change	Description of changes
ACADEMIC_TITLE	New element
ACCOUNTING_INFO	New element
ADDRESS	This element has been extended by the following sub-elements: DEPARTMENT , CONTACT_DETAILS , VAT_ID ; the sub-element EMAIL may occur more than once if the e-mail address comes with an element PUBLIC_KEY .
AGREEMENT	The element was revised and the following sub-elements were added: AGREEMENT_LINE_ID , AGREEMENT_START_DATE , AGREEMENT_END_DATE , SUPPLIER_IDREF , AGREEMENT_DESCR , MIME_INFO
AGREEMENT -->default	New attribute
AGREEMENT -->type	New attribute
AGREEMENT_DESCR	New element
AGREEMENT_END_DATE	This element replaces with a modified semantics the former DATETIME element and its type='agreement_end_date' attribute.
AGREEMENT_LINE_ID	New element
AGREEMENT_START_DATE	This element replaces with a modified semantics the former DATETIME element and its type='agreement_start_date' attribute.
AUTHENTICATION	New element
BUYER_IDREF	This new element replaces together with the PARTY element the BUYER element.
BUYER_PID	This new element replaces the BUYER_AID element.
CONFIG_INFO	New element
CONTACT_DESCR	New element
CONTACT_DETAILS	New element
CONTACT_ID	New element
CONTACT_NAME	New element
CONTACT_ROLE	New element
COST_ACCOUNT	New element
COST_CATEGORY_ID	New element
COST_TYPE	New element
COUNTRY_CODED	New element
DEFAULT_FLAG	New element

Change	Description of changes
DEPARTMENT	New element
EMAIL	The maximum length has been extended from 100 characters to 250 characters.
EMAILS	New element
ENDVALUE	New element
FAX -->type	New attribute
FEATURE	The element was revised and the following sub-elements were added: FREF (in 2005fd CLASSIFICATION_FEATURE_REF), CLASSIFICATION_SYSTEM_FEATURE_TEMPLATE , VALUE_IDREF , FVALUE_TYPE
FEATURE_CONTENT	New element
FT_DATATYPE =count	New value
FT_DATATYPE =date	New value
FT_DATATYPE =date-time	New value
FT_DATATYPE =float	New value
FT_DATATYPE =time	New value
FT_DESCR	The maximum length has been extended from 250 characters to 16,000 characters.
FT_FACET	New element
FT_FACETS	New element
FT_NAME	The maximum length has been extended from 60 characters to 80 characters.
FT_NOTE	New element
FT_REMARK	New element
FT_SHORTNAME	New element
FT_SOURCE	New element
FT_SYNONYMS	New element
FT_UNIT	The maximum length has been extended from 20 characters to 80 characters.
FT_UNIT_IDREF	This new element replaces with a modified semantics the former FT_UNIT element.
FT_VALENCY	New element
FT_VALUE	New element
FT_VALUES	New element

Change	Description of changes
FT_VERSION	New element
FVALUE_TYPE	New element
GROUP_PRODUCT_ORDER	New element
INCOTERM	New element
INTERNATIONAL_PID	This new element replaces with an increased maximum field length (100 characters instead of 14 respectively 50 characters) the former EAN and SUPPLIER_ALT_PID elements.
INTERNATIONAL_RESTRICTIONS	New element
INTERVALVALUE	New element
LANGUAGE -->default	New attribute
LOCATION	New element
LOGIN	New element
MANUFACTURER_IDREF	New element
MANUFACTURER_PID	This new element replaces former MANUFACTURER_AID element.
MIME_ALT	The maximum length has been extended from 50 characters to 80 characters.
MIME_DATA -->contentType =application/xml	New value
MIME_PURPOSE	The list of allowed values has been extended by 'icon' and 'safety_data_sheet'.
MIME_PURPOSE =icon	New value
MIME_PURPOSE =safety_data_ sheet	New value
MIME_TYPE =application/xml	New value
ORIGINAL_DATE	New element
PARTIES	New element
PARTY	New element
PARTY_ID	New element
PARTY_IDREF	New element
PARTY_ROLE	New element
PARTY_ROLE =document_creator	New value

Change	Description of changes
PARTY_ROLE =ipp_operator	New value
PARTY_ROLE =manufacturer	New value
PARTY_ROLE =standardization_body	New value
PARTY_ROLE =supplier	New value
PASSWORD	New element
PHONE	The maximum length has been extended from 30 characters to 50 characters.
PHONE -->type	New attribute
PRICE_FLAG -->type	The list of values can now be extended. The list here contains only the predefined values.
PRICE_FLAG -->type =incl_insurance	The new value 'incl_insurance' replaces the value PRICE_FLAG -->type =incl_assurance .
PRICE_FLAG -->type =userdefined_ -	User-defined value
PRICE_UNIT	New element
PRICE_UNIT_FACTOR	New element
PRODUCT_FEATURES	This new element replaces with a modified semantics the ARTICLE_FEATURES element; it has been extended by the following sub-elements: REFERENCE_FEATURE_GROUP_ID2, GROUP_PRODUCT_ORDER
PRODUCT_TYPE	New element
REFERENCE_FEATURE_GROUP_ID2	New element
REFERENCE_FEATURE_GROUP_ID -->type	New attribute
REFERENCE_FEATURE_SYSTEM_NAME =CPV-yyyy-mm-dd	New value
REFERENCE_FEATURE_SYSTEM_NAME =EOTD-yyyy-mm-dd	New value
REFERENCE_FEATURE_SYSTEM_NAME =GPC-x.y	New value
REFERENCE_FEATURE_SYSTEM_NAME =PROFICLASS-x.y	New value
REFERENCE_FEATURE_SYSTEM_NAME =RNTD-x.y	New value

Change	Description of changes
REFERENCE_FEATURE_SYSTEM_NAME =RUS-x.y	New value
REMARKS -->type	New attribute
REVISION	New element
REVISION_DATE	New element
SOURCE_NAME	New element
SOURCE_URI	New element
STARTVALUE	New element
SUPPLIER_IDREF	This new element together with the PARTY replaces the SUPPLIER element.
SUPPLIER_PID	This new element replaces the SUPPLIER_AID element.
SYNONYM	The maximum length has been extended from 60 characters to 80 characters.
TITLE	New element
TRANSPORT	New element
TRANSPORT_REMARK	New element
URL	The maximum length has been extended from 100 characters to 250 characters.
VALUE_IDREF	New element
VALUE_ORDER	New element
VALUE_RANGE	New element
VALUE_SIMPLE	New element
VALUE_TEXT	New element
VAT_ID	New element
VERSION	New element
VERSION_DATE	New element
dtCOUNT	New data type
dtDATETIME	This new data type replaces the following types: dtDATATYPE , dtTIMETYPE and dtTIMEZONETYPE

History of changes Version 2005

Change	Description of changes
ADDRESS	The sub-elements PHONE und FAX may occur more than once, due to their type-attribute.
CALCULATION_SEQUENCE	New element
CONTACT_DETAILS	The sub-elements PHONE und FAX may occur more than once, due to their type-attribute.
CONTACT_ID	The maximum length has been extended from 50 characters to 60 characters.
EXEMPTION_REASON	New element
FEATURE	The sub-element CLASSIFICATION_FEATURE_REF was renamed to FREF . The sub-element CLASSIFICATION_SYSTEM_FEATURE_TEMPLATE was replaced with the fully identical element FTEMPLATE . The sub-element FREF was replaced with the fully identical element FT_IDREF .
FEATURE_CONTENT	The sub-element FT_DOMAIN_VALUES was renamed to FT_VALUES .
FTEMPLATE	New element
FT_DATATYPE =class_instance_type	New value
FT_DATATYPE =currency	New value
FT_DATATYPE =named_type	New value
FT_DEPENDENCIES	New element
FT_GROUP_IDREF	New element
FT_GROUP_NAME	New element
FT_SOURCE	The sub-element SOURCE_DESCR was renamed to SOURCE_NAME .
FT_VALUE	This element was named FT_DOMAIN_VALUE in BMEcat 2005 final draft, now it is named FT_VALUE .
FT_VALUES	This element was named FT_DOMAIN_VALUES and is now named FT_VALUES . The sub-element FT_DOMAIN_VALUE was renamed to FT_VALUE .
GROUP_PRODUCT_ORDER	This element was named CLASSIFICATION_GROUP_PRODUCTORDER in BMEcat 2005 final draft, now it is named GROUP_PRODUCT_ORDER .
JURISDICTION	New element
PRICE_QUANTITY	A default value was added.
PRICE_UNIT_FACTOR	A default value was added.
PRODUCT_FEATURES	The sub-element CLASSIFICATION_GROUP_PRODUCTORDER was renamed in GROUP_PRODUCT_ORDER .
SOURCE_NAME	This element was named SOURCE_DESCR in Version 2005 final draft, now it is named SOURCE_NAME . The maximum length has been reduced from 250 characters to 80 characters.
SUPPLIER_PID	The type-attribute was added to this element.

Change	Description of changes
TAX_CATEGORY	New element
TAX_TYPE	New element

History of changes Version 20v1

Change	Description of changes
ALLOW_OR_CHARGE	New element
ALLOW_OR_CHARGES_FIX	New element
ALLOW_OR_CHARGES_TOTAL_AMOUNT	New element
ALLOW_OR_CHARGE_DESCR	New element
ALLOW_OR_CHARGE_NAME	New element
ALLOW_OR_CHARGE_TYPE	New element
ALLOW_OR_CHARGE_VALUE	New element
AOC_ADDITIONAL_ITEMS	New element
AOC_MONETARY_AMOUNT	New element
AOC_ORDER_UNITS_COUNT	New element
AOC_PERCENTAGE_FACTOR	New element
CONFIG_CODE_FIX	New element
HEADER_UDX	New element
ITEM_UDX	New element
LOT_NUMBER	New element
ORDER_DESCR	New element
PRICE_BASE_FIX	New element
PRICE_UNIT_VALUE	New element
PRODUCT_COMPONENT	New element
PRODUCT_COMPONENTS	New element
PRODUCT_PRICE_FIX	New element
SERIAL_NUMBER	New element
TAX_DETAILS_FIX	New element

History of changes Version 20v2

Change	Description of changes
ALLOW_OR_CHARGE_BASE	New element
ALLOW_OR_CHARGE_TYPE =abroad	New value
ALLOW_OR_CHARGE_TYPE =administration	New value
ALLOW_OR_CHARGE_TYPE =bulk_goods	New value
ALLOW_OR_CHARGE_TYPE =cash_discount	New value
ALLOW_OR_CHARGE_TYPE =charge	New value
ALLOW_OR_CHARGE_TYPE =cod	New value
ALLOW_OR_CHARGE_TYPE =customs	New value
ALLOW_OR_CHARGE_TYPE =deposit	New value
ALLOW_OR_CHARGE_TYPE =express	New value
ALLOW_OR_CHARGE_TYPE =freight	New value
ALLOW_OR_CHARGE_TYPE =handling	New value
ALLOW_OR_CHARGE_TYPE =insurance	New value
ALLOW_OR_CHARGE_TYPE =island	New value
ALLOW_OR_CHARGE_TYPE =material	New value
ALLOW_OR_CHARGE_TYPE =overpacking	New value
ALLOW_OR_CHARGE_TYPE =packing	New value

Change	Description of changes
ALLOW_OR_CHARGE_TYPE =partial_quantity	New value
ALLOW_OR_CHARGE_TYPE =period_bonus	New value
ALLOW_OR_CHARGE_TYPE =postage	New value
ALLOW_OR_CHARGE_TYPE =project_bonus	New value
ALLOW_OR_CHARGE_TYPE =rebate	New value
ALLOW_OR_CHARGE_TYPE =recycling	New value
ALLOW_OR_CHARGE_TYPE =small_order	New value
ALLOW_OR_CHARGE_TYPE =special_work_times	New value
ALLOW_OR_CHARGE_TYPE =toll	New value
BANK_ACCOUNT	New attribut 'type' inserted.
BANK_ACCOUNT -->type	New attribute
BANK_CODE	Added new attribute 'type'.
BANK_CODE -->type	New attribute
DELIVERER_IDREF	New element
DELIVERY_IDREF	New element
FILE_NAME	New element
FILE_SIZE	New element
FINAL_DELIVERY_IDREF	New element
INVOICE_RECIPIENT_IDREF	New element
MIME_DATA	New element
MIME_DATA -->contentType	New attribute
MIME_EMBEDDED	New element

Change	Description of changes
MIME_EMBEDDED -->lang	New attribute
MIME_PURPOSE	The list of allowed values has been extended by 'manual' (manual of a product), 'directions' (directions sketch), 'conformity' (declaration of conformity), 'fax_image' (copy of a fax), 'freehand_sketch' (freehand sketch), 'mounting_guidelines' (assembly guide or installation guide etc.), 'repair_manual' (repair instructions), 'service_descr' (service description), 'service_record' (activity confirmation, record of achievement etc.) and 'warranty' (warranty).
MIME_PURPOSE =conformity	New value
MIME_PURPOSE =directions	New value
MIME_PURPOSE =fax_image	New value
MIME_PURPOSE =freehand_sketch	New value
MIME_PURPOSE =manual	New value
MIME_PURPOSE =mounting_guidelines	New value
MIME_PURPOSE =repair_manual	New value
MIME_PURPOSE =service_descr	New value
MIME_PURPOSE =service_record	New value
MIME_PURPOSE =warranty	New value
PARTIAL_DELIVERY	New element
PARTIAL_DELIVERY_LIST	New element
PARTY_ROLE	The list of pre-defined values has been extended with 'invoice_issuer' (invoicing party), 'invoice_recipient' (invoice receiving party) and 'deliverer' (transportation party, carrier).
PARTY_ROLE =deliverer	New value
PARTY_ROLE =invoice_issuer	New value
PARTY_ROLE =invoice_recipient	New value
PAYMENT_DATE	New element
TAX_NUMBER	New element

History of changes Version 20v3

Change	Description of changes
ALLOW_OR_CHARGE -->type	New attribute
ALLOW_OR_CHARGE_TYPE =customization	New value
CENTRAL_REGULATION	New element
CONTACT_DETAILS	AUTHENTICATION was added as sub-element.
CONTACT_ROLE -->type	The list of pre defined values was extended. New items are 'document_issuer' (intermediator), 'marketplace', 'payer', 'remittee' and 'central_regulator' (regulator for centralized settlement).
CUSTOMER_IDREF	New element
CUSTOMER_ORDER_REFERENCE	New element
DOEXCHANGE_PARTIES_REFERENCE	New element
DOCUMENT_ISSUER_IDREF	New element
DOCUMENT_RECIPIENT_IDREF	New element
MIME	The element MIME_EMBEDDED was added.
MIME_PURPOSE	The list of allowed values has been extended by 'verification_report' (Report of verification process).
MIME_PURPOSE =verification_report	New value
ORDER_PARTIES_REFERENCE	In combination with the element PARTY , this new element replaces the element ORDER_PARTIES.
PARTY	Sub-element ACCOUNT has been added.
PARTY_ROLE	The list of pre-defined values has been extended with 'intermediary' (intermediate party), 'marketplace' (market place), 'payer', 'remittee' and 'central_regulator' (in case of centralized settlement).
PARTY_ROLE =central_regulator	New value
PARTY_ROLE =customer	New value
PARTY_ROLE =delivery	New value
PARTY_ROLE =final_delivery	New value
PARTY_ROLE =intermediary	New value
PARTY_ROLE =marketplace	New value
PARTY_ROLE =payer	New value

Change	Description of changes
PARTY_ROLE =remittee	New value
SHIPMENT_PARTIES_REFERENCE	The element replaces the element ORDER_PARTIES in combination with PARTY .
base64Binary	New data type

History of changes Version 20fd

Change	Description of changes
ACCOUNT	The sub-element PAYMENT_TERM was deferred to the element PAYMENT_TERMS .
BANK_ACCOUNT	New attribut 'standard' inserted.
CASH	The Sub-element PAYMENT_TERM was moved to the element PAYMENT_TERMS .
CHECK	The sub-element PAYMENT_TERM was moved to the element PAYMENT_TERMS .
DAYS	New element
DEBIT	The sub-element PAYMENT_TERM was moved to PAYMENT_TERMS .
DISCOUNT_FACTOR	New element
FILE_HASH_VALUE	New element
FILE_HASH_VALUE -->lang	New attribute
FILE_HASH_VALUE -->type	New attribute
MIME_PURPOSE	The list of allowed values has been extended by 'signatur_file' (file with an external signature) and 'original_document' (the original document).
MIME_PURPOSE =original_document	New value
MIME_PURPOSE =signatur_file	New value
PAYMENT_TERMS	New element
TAX_BASE	New element
TIME_FOR_PAYMENT	New element
VALUE_DATE	New element

History of changes Version 20

Change	Description of changes
ADDRESS	The sub-element CONTACT_DETAILS was accidentally deleted in the draft version and is now inserted again.
ORDER_INFO	For processing improvements the sorting of the elements has been changed.
PARTY	Sub-element PARTY_ID set to "mandatory". Sub-element ADDRESS has been set to "multiple"
PARTY_ROLE	The list of pre-defined values has been extended with 'other'.
PARTY_ROLE =other	New value
TOTAL_AMOUNT	 Changed definition

History of changes Version 21fd

Change	Description of changes
ACCOUNT	Example added.
ADDRESS	Example adapted.
ALLOW_OR_CHARGES_FIX	Example added.
CARD	Subelements CARD_TYPE and CARD_OTHER replaced by the type-attribute of CARD. A list of available values was added. Example added.
CARD -->type	New attribute
CONTACT_DETAILS	Changed sub-element CONTACT_ID to optional. Example added.
DELIVERY_DATE	Example added.
FEATURE	Example adapted.
FILE_HASH_VALUE	A list of available values was added. Example added.
MIME	Examples adapted.
MIME_TYPE	The element is now mandatory. The recipient can now better process the incoming data since the format is always known.
ORDER_ITEM	Example added.
PARTY	Example added.
PARTY_ROLE	The list of pre-defined values has been extended with 'TrustedThirdParty'.
PARTY_ROLE =trustedthirdparty	New value
PRODUCT_COMPONENT	Example added.
PRODUCT_COMPONENTS	Sub-element PRODUCT_COMPONENT can appear unbounded now.
PRODUCT_FEATURES	Examples adapted.
PRODUCT_ID	Example added.

History of changes Version 21

Change	Description of changes
ALLOW_OR_CHARGE	Description more detailed.
ORDER_ITEM	The opportunity of partial deliveries has been integrated. Due to this change the sorting of the elements has been changed to be structural equal to the other business documents like ORDERRESPONSE.
PAYMENT_TERMS	Example added.
TIME_FOR_PAYMENT	Example changed and additional example added.
VALUE_DATE	The description of VALUE_DATE has been extended and an example has been added.

Overview of elements - order by appearance

Amount	Element name	Default value	Data type	Field length	Lang. specific	l.chg. in ver.
1	ORDER	-	-	-	-	2.0
1	_ SEQUENCE	-	-	-	-	-
1	_ ORDER_HEADER	-	-	-	-	2.0
1	_ SEQUENCE	-	-	-	-	-
0..1	_ CONTROL_INFO	-	-	-	-	-
1	_ SEQUENCE	-	-	-	-	-
0..1	_ STOP_AUTOMATIC_PROCESSING	-	dtSTRING	250	-	2.0_fd
0..1	_ GENERATOR_INFO	-	dtSTRING	250	-	-
0..1	_ GENERATION_DATE	-	dtDATETIME	-	-	2005fd
0..1	_ SOURCING_INFO	-	-	-	-	2.0
1	_ SEQUENCE	-	-	-	-	-
0..1	_ QUOTATION_ID	-	dtSTRING	250	-	2.0
0..*	_ AGREEMENT	-	-	-	-	2005fd
1	_ SEQUENCE	-	-	-	-	-
1	_ AGREEMENT_ID	-	dtSTRING	50	-	-
0..1	_ AGREEMENT_LINE_ID	-	dtSTRING	50	-	2005fd
0..1	_ AGREEMENT_START_DATE	-	dtDATETIME	-	-	2005fd
1	_ AGREEMENT_END_DATE	-	dtDATETIME	-	-	2005fd
0..1	_ SUPPLIER_IDREF	-	dtSTRING	250	-	2005fd
0..1	_ AGREEMENT_DESCR	-	dtMLSTRING	250	Yes	2005fd
0..1	_ MIME_INFO	-	-	-	-	-
1	_ SEQUENCE	-	-	-	-	-
1..*	_ MIME	-	-	-	-	21fd
1	_ SEQUENCE	-	-	-	-	-
0..1	_ MIME_TYPE	-	dtSTRING	30	-	21fd
1	_ CHOICE	-	-	-	-	-
1	_ SEQUENCE	-	-	-	-	-
1..1	_ MIME_SOURCE	-	dtMLSTRING	255	Yes	-
0..*	_ FILE_HASH_VALUE	-	dtSTRING	100	-	21fd
1..*	_ MIME_EMBEDDED	-	-	-	-	20v2
1	_ SEQUENCE	-	-	-	-	-
1	_ MIME_DATA	-	base64Binary	-	-	20v3
0..1	_ FILE_NAME	-	dtSTRING	250	-	20v2
0..1	_ FILE_SIZE	-	dtCOUNT	-	-	20v2
0..1	_ MIME_DESCR	-	dtMLSTRING	250	Yes	-
0..1	_ MIME_ALT	-	dtMLSTRING	80	Yes	2005fd
0..1	_ MIME_PURPOSE	-	dtSTRING	20	-	20v3
0..1	_ MIME_ORDER	-	dtINTEGER	-	-	-
0..1	_ CATALOG_REFERENCE	-	-	-	-	2.0
1	_ SEQUENCE	-	-	-	-	-
1	_ CATALOG_ID	-	dtSTRING	20	-	-
1	_ CATALOG_VERSION	-	dtSTRING	7	-	1.2_fd
0..1	_ CATALOG_NAME	-	dtMLSTRING	100	Yes	-
1	_ ORDER_INFO	-	-	-	-	20
1	_ SEQUENCE	-	-	-	-	-

Amount	Element name	Default value	Data type	Field length	Lang. specific	l.chg. in ver.
1	_ ORDER_ID	-	dtSTRING	250	-	2.0
1	_ ORDER_DATE	-	dtDATETIME	-	-	2005fd
0..1	_ DELIVERY_DATE	-	-	-	-	21fd
1	_ SEQUENCE	-	-	-	-	-
1	_ DELIVERY_START_DATE	-	dtDATETIME	-	-	2005fd
1	_ DELIVERY_END_DATE	-	dtDATETIME	-	-	2005fd
0..*	_ LANGUAGE	-	dtLANG	-	-	-
0..1	_ MIME_ROOT	-	dtMLSTRING	250	Yes	-
1	_ PARTIES	-	-	-	-	2005fd
1	_ SEQUENCE	-	-	-	-	-
1..*	_ PARTY	-	-	-	-	21fd
1	_ SEQUENCE	-	-	-	-	-
1..*	_ PARTY_ID	-	dtSTRING	250	-	2005fd
0..*	_ PARTY_ROLE	-	dtSTRING	20	-	21fd
0..*	_ ADDRESS	-	-	-	-	21fd
1	_ SEQUENCE	-	-	-	-	-
0..1	_ NAME	-	dtMLSTRING	50	Yes	-
0..1	_ NAME2	-	dtMLSTRING	50	Yes	-
0..1	_ NAME3	-	dtMLSTRING	50	Yes	-
0..1	_ DEPARTMENT	-	dtMLSTRING	50	Yes	2005fd
0..*	_ CONTACT_DETAILS	-	-	-	-	21fd
1	_ SEQUENCE	-	-	-	-	-
0..1	_ CONTACT_ID	-	dtSTRING	60	-	2005
1..1	_ CONTACT_NAME	-	dtMLSTRING	50	Yes	2005fd
0..1	_ FIRST_NAME	-	dtMLSTRING	50	Yes	-
0..1	_ TITLE	-	dtMLSTRING	20	Yes	2005fd
0..1	_ ACADEMIC_TITLE	-	dtMLSTRING	50	Yes	2005fd
0..*	_ CONTACT_ROLE	-	dtMLSTRING	50	Yes	2005fd
0..1	_ CONTACT_DESCR	-	dtMLSTRING	250	Yes	2005fd
0..*	_ PHONE	-	dtMLSTRING	50	Yes	2005fd
0..*	_ FAX	-	dtMLSTRING	50	Yes	-
0..1	_ URL	-	dtSTRING	255	-	2005fd
0..1	_ EMAILS	-	-	-	-	2005fd
1..*	_ SEQUENCE	-	-	-	-	-
1	_ EMAIL	-	dtSTRING	255	-	2005fd
0..*	_ PUBLIC_KEY	-	dtSTRING	64000	-	1.2_fd
0..1	_ AUTHENTICATION	-	-	-	-	2005fd
1	_ SEQUENCE	-	-	-	-	-
1	_ LOGIN	-	dtSTRING	60	-	2005fd
0..1	_ PASSWORD	-	dtSTRING	20	-	2005fd
0..1	_ STREET	-	dtMLSTRING	50	Yes	-
0..1	_ ZIP	-	dtMLSTRING	20	Yes	-
0..1	_ BOXNO	-	dtMLSTRING	20	Yes	-
0..1	_ ZIPBOX	-	dtMLSTRING	20	Yes	-
0..1	_ CITY	-	dtMLSTRING	50	Yes	-
0..1	_ STATE	-	dtMLSTRING	50	Yes	-
0..1	_ COUNTRY	-	dtMLSTRING	50	Yes	-

Amount	Element name	Default value	Data type	Field length	Lang. specific	l.chg. in ver.
0..1	_ SHIPMENT_PARTIES_REFERENCE	-	-	-	-	20v3
1	_ SEQUENCE	-	-	-	-	-
1	_ DELIVERY_IDREF	-	dtSTRING	250	-	20v2
0..1	_ FINAL_DELIVERY_IDREF	-	dtSTRING	250	-	20v2
0..1	_ DELIVERER_IDREF	-	dtSTRING	250	-	20v2
0..1	_ DOCEXCHANGE_PARTIES_REFERENCE	-	-	-	-	20v3
1	_ SEQUENCE	-	-	-	-	-
0..1	_ DOCUMENT_ISSUER_IDREF	-	dtSTRING	250	-	20v3
0..*	_ DOCUMENT_RECIPIENT_IDREF	-	dtSTRING	250	-	20v3
0..1	_ CURRENCY	-	dtCURRENCIES	-	-	-
0..1	_ PAYMENT	-	-	-	-	2.0
1	_ SEQUENCE	-	-	-	-	-
1	_ CHOICE	-	-	-	-	-
1	_ CARD	-	-	-	-	21fd
1	_ SEQUENCE	-	-	-	-	-
1	_ CARD_NUM	-	dtSTRING	16	-	2.0
0..1	_ CARD_AUTH_CODE	-	dtSTRING	10	-	2.0
0..1	_ CARD_REF_NUM	-	dtSTRING	50	-	2.0
1	_ CARD_EXPIRATION_DATE	-	dtDATETIME	-	-	2005fd
1	_ CARD HOLDER_NAME	-	dtSTRING	50	-	2.0
1..*	_ ACCOUNT	-	-	-	-	21fd
1	_ SEQUENCE	-	-	-	-	-
1	_ HOLDER	-	dtSTRING	50	-	2.0
1	_ BANK_ACCOUNT	-	dtSTRING	100	-	20fd
0..1	_ BANK_CODE	-	dtSTRING	50	-	20v2
0..1	_ BANK_NAME	-	dtSTRING	50	-	2.0
0..1	_ BANK_COUNTRY	-	dtCOUNTRIES	-	-	2.0
1	_ DEBIT	-	dtBOOLEAN	-	-	20fd
1	_ CHECK	-	dtBOOLEAN	-	-	20fd
1	_ CASH	-	dtBOOLEAN	-	-	20fd
0..1	_ CENTRAL_REGULATION	false	dtBOOLEAN	-	-	20v3
0..1	_ PAYMENT_TERMS	-	-	-	-	21
0..1	_ SEQUENCE	-	-	-	-	-
0..*	_ PAYMENT_TERM	-	dtSTRING	250	-	2.0
0..*	_ TIME_FOR_PAYMENT	-	-	-	-	21
1	_ SEQUENCE	-	-	-	-	-
1	_ CHOICE	-	-	-	-	-
1	_ PAYMENT_DATE	-	dtDATETIME	-	-	2005fd
1	_ DAYS	-	dtCOUNT	-	-	2005fd
0..1	_ CHOICE	-	-	-	-	-
0..1	_ DISCOUNT_FACTOR	-	dtFLOAT	-	-	20fd
0..1	_ ALLOW_OR_CHARGES_FIX	-	-	-	-	21fd
1	_ SEQUENCE	-	-	-	-	-
1..*	_ ALLOW_OR_CHARGE	-	-	-	-	21
1	_ SEQUENCE	-	-	-	-	-
0..1	_ ALLOW_OR_CHARGE_SEQUENCE	-	dtCOUNT	-	-	2005fd
0..1	_ ALLOW_OR_CHARGE_NAME	-	dtMLSTRING	80	Yes	20v1

Amount	Element name	Default value	Data type	Field length	Lang. specific	l.chg. in ver.
0..1	_ SUPPLIER_IDREF	-	dtSTRING	250	-	2005fd
0..1	_ CONFIG_CODE_FIX	-	dtSTRING	6000	-	20v1
0..*	_ LOT_NUMBER	-	dtSTRING	80	-	20v1
0..*	_ SERIAL_NUMBER	-	dtSTRING	80	-	20v1
0..*	_ INTERNATIONAL_PID	-	dtSTRING	100	-	2005fd
0..*	_ BUYER_PID	-	dtSTRING	50	-	2005fd
0..1	_ DESCRIPTION_SHORT	-	dtMLSTRING	150	Yes	-
0..1	_ DESCRIPTION_LONG	-	dtMLSTRING	64000	Yes	1.2_fd
0..1	_ MANUFACTURER_INFO	-	-	-	-	2.0_fd
1	_ SEQUENCE	-	-	-	-	-
1	_ MANUFACTURER_IDREF	-	dtSTRING	250	-	2005fd
1	_ MANUFACTURER_PID	-	dtSTRING	50	-	2005fd
0..1	_ MANUFACTURER_TYPE_DESCR	-	dtMLSTRING	50	Yes	1.2_fd
0..1	_ PRODUCT_TYPE	-	dtSTRING	50	-	2005fd
0..1	_ PRODUCT_FEATURES	-	-	-	-	21fd
1	_ SEQUENCE	-	-	-	-	-
0..1	_ REFERENCE_FEATURE_SYSTEM_NAME	-	dtSTRING	80	-	-
0..*	_ REFERENCE_FEATURE_GROUP_ID	-	dtSTRING	60	-	-
0..*	_ REFERENCE_FEATURE_GROUP_NAME	-	dtMLSTRING	60	Yes	-
0..*	_ REFERENCE_FEATURE_GROUP_ID2	-	dtSTRING	60	-	2005fd
0..1	_ GROUP_PRODUCT_ORDER	-	dtINTEGER	-	-	2005
0..*	_ FEATURE	-	-	-	-	21fd
1	_ SEQUENCE	-	-	-	-	-
1	_ CHOICE	-	-	-	-	-
1..1	_ FNAME	-	dtMLSTRING	60	Yes	-
1	_ FT_IDREF	-	dtSTRING	60	-	-
1	_ FTEMPLATE	-	-	-	-	2005
1	_ SEQUENCE	-	-	-	-	-
1	_ FT_ID	-	dtSTRING	60	-	-
1	_ FT_NAME	-	dtMLSTRING	80	Yes	2005fd
0..1	_ FT_SHORTNAME	-	dtMLSTRING	80	Yes	2005fd
0..1	_ FT_DESCR	-	dtMLSTRING	16000	Yes	2005fd
0..1	_ FT_VERSION	-	-	-	-	2005fd
1	_ SEQUENCE	-	-	-	-	-
1	_ VERSION	-	dtSTRING	20	-	2005fd
0..1	_ VERSION_DATE	-	dtDATETIME	-	-	2005fd
0..1	_ REVISION	-	dtSTRING	20	-	2005fd
0..1	_ REVISION_DATE	-	dtDATETIME	-	-	2005fd
0..1	_ ORIGINAL_DATE	-	dtDATETIME	-	-	2005fd
0..1	_ CHOICE	-	-	-	-	-
0..1	_ FT_GROUP_IDREF	-	dtSTRING	60	-	2005
0..1	_ FT_GROUP_NAME	-	dtMLSTRING	80	Yes	2005
0..1	_ FT_DEPENDENCIES	-	-	-	-	2005
1	_ SEQUENCE	-	-	-	-	-
1..*	_ FT_IDREF	-	dtSTRING	60	-	-
0..1	_ FEATURE_CONTENT	-	-	-	-	2005
1	_ SEQUENCE	-	-	-	-	-

Amount	Element name	Default value	Data type	Field length	Lang. specific	l.chg. in ver.
0..*	FEATURE	-	-	-	-	21fd
1	SEQUENCE	-	-	-	-	-
1	CHOICE	-	-	-	-	-
1..1	FNAME	-	dtMLSTRING	60	Yes	-
1	FT_IDREF	-	dtSTRING	60	-	-
1	FTEMPLATE	-	-	-	-	2005
1	SEQUENCE	-	-	-	-	-
1	FT_ID	-	dtSTRING	60	-	-
1	FT_NAME	-	dtMLSTRING	80	Yes	2005fd
0..1	FT_SHORTNAME	-	dtMLSTRING	80	Yes	2005fd
0..1	FT_DESCR	-	dtMLSTRING	16000	Yes	2005fd
0..1	FT_VERSION	-	-	-	-	2005fd
1	SEQUENCE	-	-	-	-	-
1	VERSION	-	dtSTRING	20	-	2005fd
0..1	VERSION_DATE	-	dtDATETIME	-	-	2005fd
0..1	REVISION	-	dtSTRING	20	-	2005fd
0..1	REVISION_DATE	-	dtDATETIME	-	-	2005fd
0..1	ORIGINAL_DATE	-	dtDATETIME	-	-	2005fd
0..1	CHOICE	-	-	-	-	-
0..1	FT_GROUP_IDREF	-	dtSTRING	60	-	2005
0..1	FT_GROUP_NAME	-	dtMLSTRING	80	Yes	2005
0..1	FT_DEPENDENCIES	-	-	-	-	2005
1	SEQUENCE	-	-	-	-	-
1..*	FT_IDREF	-	dtSTRING	60	-	-
0..1	FEATURE_CONTENT	-	-	-	-	2005
1	SEQUENCE	-	-	-	-	-
1	FT_DATATYPE	-	dtSTRING	20	-	-
0..1	FT_FACETS	-	-	-	-	2005fd
1	SEQUENCE	-	-	-	-	-
1..4	FT_FACET	-	dtSTRING	20	-	2005fd
0..1	FT_VALUES	-	-	-	-	2005
1	SEQUENCE	-	-	-	-	-
1..*	FT_VALUE	-	-	-	-	2005
1	SEQUENCE	-	-	-	-	-
1	CHOICE	-	-	-	-	-
1	VALUE_IDREF	-	dtSTRING	60	-	2005fd
1	VALUE_SIMPLE	-	dtSTRING	80	-	2005fd
1	VALUE_TEXT	-	dtMLSTRING	80	Yes	2005fd
1	VALUE_RANGE	-	-	-	-	2005fd
1	SEQUENCE	-	-	-	-	-
1	STARTVALUE	-	dtNUMBER	-	-	2005fd
1	ENDVALUE	-	dtNUMBER	-	-	2005fd
0..1	INTERVALVALUE	-	dtNUMBER	-	-	2005fd
0..1	MIME_INFO	-	-	-	-	-
1	SEQUENCE	-	-	-	-	-
1..*	MIME	-	-	-	-	-
1	SEQUENCE	-	-	-	-	-

Amount	Element name	Default value	Data type	Field length	Lang. specific	l.chg. in ver.
1	ORDER_UNIT	-	dtPUNIT	-	-	1.2_fd
0..1	PRODUCT_PRICE_FIX	-	-	-	-	20v1
1	SEQUENCE	-	-	-	-	-
1	PRICE_AMOUNT	-	dtNUMBER	-	-	-
0..1	ALLOW_OR_CHARGES_FIX	-	-	-	-	21fd
1	SEQUENCE	-	-	-	-	-
1..*	ALLOW_OR_CHARGE	-	-	-	-	21
1	SEQUENCE	-	-	-	-	-
0..1	ALLOW_OR_CHARGE_SEQUENCE	-	dtCOUNT	-	-	2005fd
0..1	ALLOW_OR_CHARGE_NAME	-	dtMLSTRING	80	Yes	20v1
0..1	ALLOW_OR_CHARGE_TYPE	-	dtSTRING	30	-	20v1
0..1	ALLOW_OR_CHARGE_DESCR	-	dtMLSTRING	250	Yes	20v1
0..1	ALLOW_OR_CHARGE_VALUE	-	-	-	-	20v1
1	CHOICE	-	-	-	-	-
1	AOC_PERCENTAGE_FACTOR	-	dtFLOAT	-	-	20v1
1	AOC_MONETARY_AMOUNT	-	dtFLOAT	-	-	20v1
1	AOC_ORDER_UNITS_COUNT	-	-	-	-	20v1
1	AOC_ADDITIONAL_ITEMS	-	dtSTRING	250	-	20v1
0..1	ALLOW_OR_CHARGE_BASE	-	dtFLOAT	-	-	20v2
0..1	ALLOW_OR_CHARGES_TOTAL_AMOUNT	-	dtFLOAT	-	-	20v1
0..*	PRICE_FLAG	-	dtBOOLEAN	-	-	-
0..*	TAX_DETAILS_FIX	-	-	-	-	20v1
1	SEQUENCE	-	-	-	-	-
0..1	CALCULATION_SEQUENCE	1	dtCOUNT	-	-	2005fd
0..1	TAX_CATEGORY	-	dtSTRING	80	-	2005
0..1	TAX_TYPE	vat	dtSTRING	250	-	2005
0..1	TAX	-	dtNUMBER	-	-	-
0..1	TAX_AMOUNT	-	dtNUMBER	-	-	-
0..1	TAX_BASE	-	dtNUMBER	-	-	20fd
0..1	EXEMPTION_REASON	-	dtMLSTRING	250	Yes	2005
0..1	JURISDICTION	-	dtMLSTRING	250	Yes	2005
0..1	PRICE_QUANTITY	1	dtNUMBER	-	-	2005
0..1	PRICE_BASE_FIX	-	-	-	-	20v1
1	SEQUENCE	-	-	-	-	-
1	PRICE_UNIT_VALUE	-	dtFLOAT	-	-	20v1
1	PRICE_UNIT	-	dtPUNIT	-	-	1.2_fd
0..1	PRICE_UNIT_FACTOR	1	dtFLOAT	-	-	2005
1	QUANTITY	-	dtNUMBER	-	-	2.0
1	ORDER_UNIT	-	dtPUNIT	-	-	1.2_fd
0..1	PRODUCT_PRICE_FIX	-	-	-	-	20v1
1	SEQUENCE	-	-	-	-	-
1	PRICE_AMOUNT	-	dtNUMBER	-	-	-
0..1	ALLOW_OR_CHARGES_FIX	-	-	-	-	21fd
1	SEQUENCE	-	-	-	-	-
1..*	ALLOW_OR_CHARGE	-	-	-	-	21
1	SEQUENCE	-	-	-	-	-
0..1	ALLOW_OR_CHARGE_SEQUENCE	-	dtCOUNT	-	-	2005fd

Overview of elements - alphabetical order

Element name	Default value	Data type	Field length	Lang. specific	l.chg. in ver.
ACADEMIC_TITLE	-	dtMLSTRING	50	Yes	2005fd
ACCOUNT	-	-	-	-	21fd
ACCOUNTING_INFO	-	-	-	-	2005fd
ADDRESS	-	-	-	-	21fd
ADDRESS_REMARKS	-	dtMLSTRING	250	Yes	-
AGREEMENT	-	-	-	-	2005fd
AGREEMENT_DESCR	-	dtMLSTRING	250	Yes	2005fd
AGREEMENT_END_DATE	-	dtDATETIME	-	-	2005fd
AGREEMENT_ID	-	dtSTRING	50	-	-
AGREEMENT_LINE_ID	-	dtSTRING	50	-	2005fd
AGREEMENT_START_DATE	-	dtDATETIME	-	-	2005fd
ALLOW_OR_CHARGE	-	-	-	-	21
ALLOW_OR_CHARGES_FIX	-	-	-	-	21fd
ALLOW_OR_CHARGES_TOTAL_AMOUNT	-	dtFLOAT	-	-	20v1
ALLOW_OR_CHARGE_BASE	-	dtFLOAT	-	-	20v2
ALLOW_OR_CHARGE_DESCR	-	dtMLSTRING	250	Yes	20v1
ALLOW_OR_CHARGE_NAME	-	dtMLSTRING	80	Yes	20v1
ALLOW_OR_CHARGE_SEQUENCE	-	dtCOUNT	-	-	2.0v1
ALLOW_OR_CHARGE_TYPE	-	dtSTRING	30	-	20v1
ALLOW_OR_CHARGE_VALUE	-	-	-	-	20v1
AOC_ADDITIONAL_ITEMS	-	dtSTRING	250	-	20v1
AOC_MONETARY_AMOUNT	-	dtFLOAT	-	-	20v1
AOC_ORDER_UNITS_COUNT	-	-	-	-	20v1
AOC_PERCENTAGE_FACTOR	-	dtFLOAT	-	-	20v1
AUTHENTICATION	-	-	-	-	2005fd

Element name	Default value	Data type	Field length	Lang. specific	l.chg. in ver.
BANK_ACCOUNT	-	dtSTRING	100	-	20fd
BANK_CODE	-	dtSTRING	50	-	20v2
BANK_COUNTRY	-	dtCOUNTRIES	-	-	2.0
BANK_NAME	-	dtSTRING	50	-	2.0
BOXNO	-	dtMLSTRING	20	Yes	-
BUYER_IDREF	-	dtSTRING	250	-	2005fd
BUYER_PID	-	dtSTRING	50	-	2005fd
CALCULATION_SEQUENCE	1	dtCOUNT	-	-	2005
CARD	-	-	-	-	21fd
CARD_AUTH_CODE	-	dtSTRING	10	-	2.0
CARD_EXPIRATION_DATE	-	dtDATETIME	-	-	2.0
CARD_HOLDER_NAME	-	dtSTRING	50	-	2.0
CARD_NUM	-	dtSTRING	16	-	2.0
CARD_REF_NUM	-	dtSTRING	50	-	2.0
CASH	-	dtBOOLEAN	-	-	20fd
CATALOG_ID	-	dtSTRING	20	-	-
CATALOG_NAME	-	dtMLSTRING	100	Yes	-
CATALOG_REFERENCE	-	-	-	-	2.0
CATALOG_VERSION	-	dtSTRING	7	-	1.2_fd
CENTRAL_REGULATION	false	dtBOOLEAN	-	-	20v3
CHECK	-	dtBOOLEAN	-	-	20fd
CITY	-	dtMLSTRING	50	Yes	-
CONFIG_CODE_FIX	-	dtSTRING	6000	-	20v1
CONFIG_INFO	-	-	-	-	2005fd
CONTACT_DESCR	-	dtMLSTRING	250	Yes	2005fd
CONTACT_DETAILS	-	-	-	-	21fd

Element name	Default value	Data type	Field length	Lang. specific	l.chg. in ver.
CONTACT_ID	-	dtSTRING	60	-	2005
CONTACT_NAME	-	dtMLSTRING	50	Yes	2005fd
CONTACT_ROLE	-	dtMLSTRING	50	Yes	2005fd
CONTROL_INFO	-	-	-	-	-
COST_ACCOUNT	-	dtSTRING	64	-	2005fd
COST_CATEGORY_ID	-	dtSTRING	64	-	2005fd
COST_TYPE	-	dtSTRING	64	-	2005fd
COUNTRY	-	dtMLSTRING	50	Yes	-
COUNTRY_CODED	-	dtCOUNTRIES	-	-	2005fd
CURRENCY	-	dtCURRENCIES	-	-	-
CUSTOMER_IDREF	-	dtSTRING	250	-	20v3
CUSTOMER_ORDER_REFERENCE	-	-	-	-	20v3
DAYS	-	dtCOUNT	-	-	20fd
DEBIT	-	dtBOOLEAN	-	-	20fd
DEFAULT_FLAG	-	dtBOOLEAN	-	-	2005fd
DELIVERER_IDREF	-	dtSTRING	250	-	20v2
DELIVERY_DATE	-	-	-	-	21fd
DELIVERY_END_DATE	-	dtDATETIME	-	-	2.0
DELIVERY_IDREF	-	dtSTRING	250	-	20v2
DELIVERY_START_DATE	-	dtDATETIME	-	-	2.0
DEPARTMENT	-	dtMLSTRING	50	Yes	2005fd
DESCRIPTION_LONG	-	dtMLSTRING	64000	Yes	1.2_fd
DESCRIPTION_SHORT	-	dtMLSTRING	150	Yes	-
DISCOUNT_FACTOR	-	dtFLOAT	-	-	20fd
DOEXCHANGE_PARTIES_REFERENCE	-	-	-	-	20v3
DOCUMENT_ISSUER_IDREF	-	dtSTRING	250	-	20v3

Element name	Default value	Data type	Field length	Lang. specific	l.chg. in ver.
DOCUMENT_RECIPIENT_IDREF	-	dtSTRING	250	-	20v3
EMAIL	-	dtSTRING	255	-	2005fd
EMAILS	-	-	-	-	2005fd
ENDVALUE	-	dtNUMBER	-	-	2005fd
EXEMPTION_REASON	-	dtMLSTRING	250	Yes	2005
FAX	-	dtMLSTRING	50	Yes	-
FDESCR	-	dtMLSTRING	250	Yes	1.2_fd
FEATURE	-	-	-	-	21fd
FEATURE_CONTENT	-	-	-	-	2005
FILE_HASH_VALUE	-	dtSTRING	100	-	21fd
FILE_NAME	-	dtSTRING	250	-	20v2
FILE_SIZE	-	dtCOUNT	-	-	20v2
FINAL_DELIVERY_IDREF	-	dtSTRING	250	-	20v2
FIRST_NAME	-	dtMLSTRING	50	Yes	-
FNAME	-	dtMLSTRING	60	Yes	-
FORDER	-	dtINTEGER	-	-	-
FTEMPLATE	-	-	-	-	2005
FT_DATATYPE	-	dtSTRING	20	-	-
FT_DEPENDENCIES	-	-	-	-	2005
FT_DESCR	-	dtMLSTRING	16000	Yes	2005fd
FT_FACET	-	dtSTRING	20	-	2005fd
FT_FACETS	-	-	-	-	2005fd
FT_GROUP_IDREF	-	dtSTRING	60	-	2005
FT_GROUP_NAME	-	dtMLSTRING	80	Yes	2005
FT_ID	-	dtSTRING	60	-	-
FT_IDREF	-	dtSTRING	60	-	-

Element name	Default value	Data type	Field length	Lang. specific	l.chg. in ver.
FT_MANDATORY	-	dtBOOLEAN	-	-	-
FT_NAME	-	dtMLSTRING	80	Yes	2005fd
FT_NOTE	-	dtMLSTRING	16000	Yes	2005fd
FT_ORDER	-	dtINTEGER	-	-	-
FT_REMARK	-	dtMLSTRING	16000	Yes	2005fd
FT_SHORTNAME	-	dtMLSTRING	80	Yes	2005fd
FT_SOURCE	-	-	-	-	2005
FT_SYMBOL	-	dtMLSTRING	20	Yes	1.2
FT_SYNONYMS	-	-	-	-	2005fd
FT_UNIT	-	dtSTRING	80	-	2005fd
FT_UNIT_IDREF	-	dtSTRING	60	-	2005fd
FT_VALENCY	univalent	dtSTRING	20	-	2005fd
FT_VALUE	-	-	-	-	2005
FT_VALUES	-	-	-	-	2005
FT_VERSION	-	-	-	-	2005fd
FUNIT	-	dtSTRING	20	-	-
FVALUE	-	dtMLSTRING	60	Yes	1.2_fd
FVALUE_DETAILS	-	dtMLSTRING	250	Yes	1.2_fd
FVALUE_TYPE	-	dtSTRING	20	-	2005fd
GENERATION_DATE	-	dtDATETIME	-	-	2.0_fd
GENERATOR_INFO	-	dtSTRING	250	-	-
GROUP_PRODUCT_ORDER	-	dtINTEGER	-	-	2005
HEADER_UDX	-	udxHEADER	-	-	20v1
HOLDER	-	dtSTRING	50	-	2.0
INCOTERM	-	dtSTRING	3	-	2005fd

Element name	Default value	Data type	Field length	Lang. specific	l.chg. in ver.
INTERNATIONAL_PID	-	dtSTRING	100	-	2005fd
INTERNATIONAL_RESTRICTIONS	-	dtSTRING	250	-	2005fd
INTERVALVALUE	-	dtNUMBER	-	-	2005fd
INVOICE_RECIPIENT_IDREF	-	dtSTRING	250	-	20v2
ITEM_UDX	-	udxITEM	-	-	20v1
JURISDICTION	-	dtMLSTRING	250	Yes	2005
LANGUAGE	-	dtLANG	-	-	-
LINE_ITEM_ID	-	dtSTRING	50	-	2.0
LOCATION	-	dtSTRING	250	-	2005fd
LOGIN	-	dtSTRING	60	-	2005fd
LOT_NUMBER	-	dtSTRING	80	-	20v1
MANUFACTURER_IDREF	-	dtSTRING	250	-	2005fd
MANUFACTURER_INFO	-	-	-	-	2.0_fd
MANUFACTURER_PID	-	dtSTRING	50	-	2005fd
MANUFACTURER_TYPE_DESCR	-	dtMLSTRING	50	Yes	1.2_fd
MIME	-	-	-	-	21fd
MIME_ALT	-	dtMLSTRING	80	Yes	2005fd
MIME_DATA	-	base64Binary	-	-	20v2
MIME_DESCR	-	dtMLSTRING	250	Yes	-
MIME_EMBEDDED	-	-	-	-	20v2
MIME_INFO	-	-	-	-	-
MIME_ORDER	-	dtINTEGER	-	-	-
MIME_PURPOSE	-	dtSTRING	20	-	20v3
MIME_ROOT	-	dtMLSTRING	250	Yes	-
MIME_SOURCE	-	dtMLSTRING	255	Yes	-
MIME_TYPE	-	dtSTRING	30	-	21fd

Element name	Default value	Data type	Field length	Lang. specific	l.chg. in ver.
NAME	-	dtMLSTRING	50	Yes	-
NAME2	-	dtMLSTRING	50	Yes	-
NAME3	-	dtMLSTRING	50	Yes	-
ORDER	-	-	-	-	2.0
ORDER_DATE	-	dtDATETIME	-	-	2.0
ORDER_DESCR	-	dtMLSTRING	300	Yes	20v1
ORDER_HEADER	-	-	-	-	2.0
ORDER_ID	-	dtSTRING	250	-	2.0
ORDER_INFO	-	-	-	-	20
ORDER_ITEM	-	-	-	-	21
ORDER_ITEM_LIST	-	-	-	-	2.0
ORDER_PARTIES_REFERENCE	-	-	-	-	20v3
ORDER_SUMMARY	-	-	-	-	2.0
ORDER_UNIT	-	dtPUNIT	-	-	-
ORIGINAL_DATE	-	dtDATETIME	-	-	2005fd
PARTIAL_DELIVERY	-	-	-	-	20v2
PARTIAL_DELIVERY_LIST	-	-	-	-	20v2
PARTIAL_SHIPMENT_ALLOWED	-	dtBOOLEAN	-	-	2.0
PARTIES	-	-	-	-	2005fd
PARTY	-	-	-	-	21fd
PARTY_ID	-	dtSTRING	250	-	2005fd
PARTY_IDREF	-	dtSTRING	250	-	2005fd
PARTY_ROLE	-	dtSTRING	20	-	21fd
PASSWORD	-	dtSTRING	20	-	2005fd
PAYMENT	-	-	-	-	2.0
PAYMENT_DATE	-	dtDATETIME	-	-	20v2

Element name	Default value	Data type	Field length	Lang. specific	l.chg. in ver.
PAYMENT_TERM	-	dtSTRING	250	-	2.0
PAYMENT_TERMS	-	-	-	-	21
PHONE	-	dtMLSTRING	50	Yes	2005fd
PRICE_AMOUNT	-	dtNUMBER	-	-	-
PRICE_BASE_FIX	-	-	-	-	20v1
PRICE_FLAG	-	dtBOOLEAN	-	-	-
PRICE_LINE_AMOUNT	-	dtNUMBER	-	-	-
PRICE_QUANTITY	1	dtNUMBER	-	-	2005
PRICE_UNIT	-	dtPUNIT	-	-	2005fd
PRICE_UNIT_FACTOR	1	dtFLOAT	-	-	2005
PRICE_UNIT_VALUE	-	dtFLOAT	-	-	20v1
PRODUCT_COMPONENT	-	-	-	-	21fd
PRODUCT_COMPONENTS	-	-	-	-	21fd
PRODUCT_FEATURES	-	-	-	-	21fd
PRODUCT_ID	-	-	-	-	21fd
PRODUCT_PRICE_FIX	-	-	-	-	20v1
PRODUCT_TYPE	-	dtSTRING	50	-	2005fd
PUBLIC_KEY	-	dtSTRING	64000	-	1.2_fd
QUANTITY	-	dtNUMBER	-	-	2.0
QUOTATION_ID	-	dtSTRING	250	-	2.0
REFERENCE_FEATURE_GROUP_ID	-	dtSTRING	60	-	-
REFERENCE_FEATURE_GROUP_ID2	-	dtSTRING	60	-	2005fd
REFERENCE_FEATURE_GROUP_NAME	-	dtMLSTRING	60	Yes	-
REFERENCE_FEATURE_SYSTEM_NAME	-	dtSTRING	80	-	-
REMARKS	-	dtMLSTRING	64000	Yes	-
REVISION	-	dtSTRING	20	-	2005fd

Element name	Default value	Data type	Field length	Lang. specific	l.chg. in ver.
REVISION_DATE	-	dtDATETIME	-	-	2005fd
SERIAL_NUMBER	-	dtSTRING	80	-	20v1
SHIPMENT_PARTIES_REFERENCE	-	-	-	-	20v3
SOURCE_NAME	-	dtMLSTRING	80	Yes	2005
SOURCE_URI	-	dtSTRING	255	-	2005fd
SOURCING_INFO	-	-	-	-	2.0
SPECIAL_TREATMENT_CLASS	-	dtSTRING	20	-	-
STARTVALUE	-	dtNUMBER	-	-	2005fd
STATE	-	dtMLSTRING	50	Yes	-
STOP_AUTOMATIC_PROCESSING	-	dtSTRING	250	-	2.0_fd
STREET	-	dtMLSTRING	50	Yes	-
SUPPLIER_IDREF	-	dtSTRING	250	-	2005fd
SUPPLIER_PID	-	dtSTRING	32	-	2005
SYNONYM	-	dtMLSTRING	80	Yes	2005fd
TAX	-	dtNUMBER	-	-	-
TAX_AMOUNT	-	dtNUMBER	-	-	-
TAX_BASE	-	dtNUMBER	-	-	20fd
TAX_CATEGORY	-	dtSTRING	80	-	2005
TAX_DETAILS_FIX	-	-	-	-	20v1
TAX_NUMBER	-	dtSTRING	50	-	20v2
TAX_TYPE	vat	dtSTRING	250	-	2005
TERMS_AND_CONDITIONS	-	dtSTRING	250	-	2.0
TIME_FOR_PAYMENT	-	-	-	-	21
TITLE	-	dtMLSTRING	20	Yes	2005fd
TOTAL_AMOUNT	-	dtNUMBER	-	-	20
TOTAL_ITEM_NUM	-	dtCOUNT	-	-	2.0

Element name	Default value	Data type	Field length	Lang. specific	l.chg. in ver.
TRANSPORT	-	-	-	-	2005fd
TRANSPORT_REMARK	-	dtMLSTRING	64000	Yes	2005fd
URL	-	dtSTRING	255	-	2005fd
VALUE_DATE	-	dtDATETIME	-	-	21
VALUE_IDREF	-	dtSTRING	60	-	2005fd
VALUE_ORDER	-	dtINTEGER	-	-	2005fd
VALUE_RANGE	-	-	-	-	2005fd
VALUE_SIMPLE	-	dtSTRING	80	-	2005fd
VALUE_TEXT	-	dtMLSTRING	80	Yes	2005fd
VAT_ID	-	dtSTRING	50	-	2005fd
VERSION	-	dtSTRING	20	-	2005fd
VERSION_DATE	-	dtDATETIME	-	-	2005fd
ZIP	-	dtMLSTRING	20	Yes	-
ZIPBOX	-	dtMLSTRING	20	Yes	-